

OUTDOOR

**TRIO Leuchten GmbH**

Gut Nierhof 17  
D-59757 Arnsberg  
T +49 2931 9666-0  
F +49 2931 9666-28  
info@trio-leuchten.de  
www.trio-leuchten.de

**Reality Leuchten GmbH**

Gut Nierhof 17  
D-59757 Arnsberg  
T +49 2931 9666-99  
F +49 2931 9666-98  
info@reality-leuchten.de  
www.reality-leuchten.de

**TRIO International GmbH**

Gut Nierhof 17  
D-59757 Arnsberg  
T +49 2931 9666-587  
F +49 2931 9666-56  
info@trio-lighting.com  
www.trio-lighting.com

 @trioleuchten

 /trioleuchten

 @trio.lighting



 **TRIO**  
LIGHTING FOR YOU

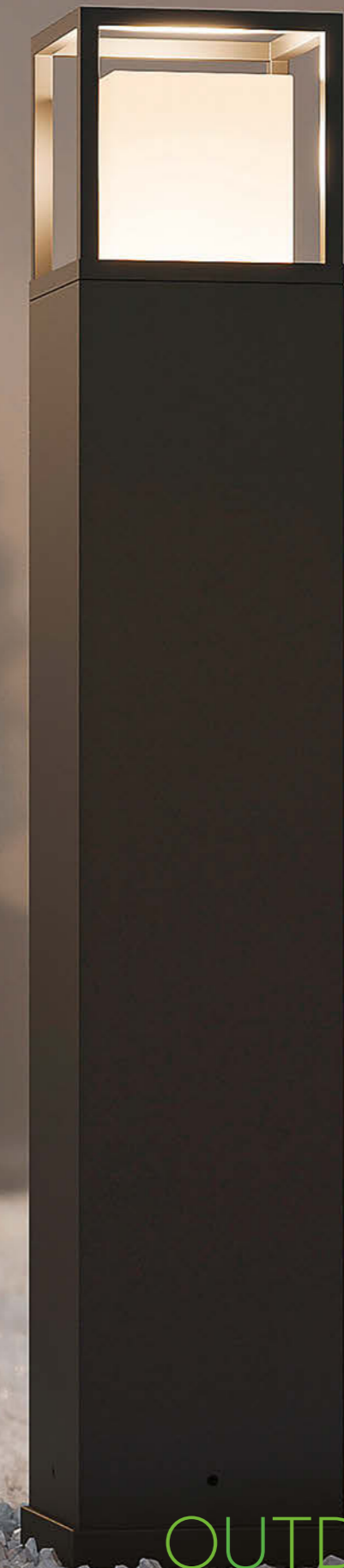

2023

OUTDOOR  
AUSSENLEUCHTEN  
OUTDOOR LUMINAIRES



2023

OUTDOOR  
AUSSENLEUCHTEN  
OUTDOOR LUMINAIRES



power efficiency. We hope you enjoy our new outdoor collection.

Dès que le soleil se couche, un éclairage extérieur innovant est indispensable. Un espace extérieur bien éclairé offre non seulement la sécurité, mais vous aide aussi à vous orienter et crée une agréable ambiance autour de votre maison. Les luminaires extérieurs doivent répondre à des exigences de qualité élevées afin de résister sans dommage aux aléas climatiques telles que l'humidité, la pluie, la neige et les variations saisonnières de température. Nos luminaires d'extérieur

serve para orientarse y crean una atmósfera alrededor de tu casa. La iluminación exterior debe cumplir unos altos requisitos de calidad para soportar las diferentes condiciones de humedad, lluvia y nieve, así como las condiciones estacionales de oscilación de temperaturas. Nuestra iluminación exterior está fabricada en aluminio fundido a presión de alta calidad y aseguran la seguridad operativa durante toda su vida, en cualquier clima, 365 días al año. La moderna tecnología LED proporciona también una iluminación de buena calidad y una gran eficiencia energética. Le deseamos una gran satisfacción con nuestra nueva colección de exterior.

și garantează siguranța în operare pe parcursul întregii durate de exploatare, în orice condiții meteo, timp de 365 de zile pe an. Tehnologia LED modernă asigură suplimentar o calitate bună a iluminatului și o eficiență energetică înaltă. Vă dorim să vă bucurați de colecția noastră outdoor.

Kun aurinko laskee, ei innovatiiviseen ulkovalaistukseen pitäisi tarvita puuttua. Hyvin valaistu ulkoalue tarjoaa turvallisuuden lisäksi myös kulkureittien ohjausta ja luo tunnelmaa kodin ympärille. Ulkovalaisimien on täytettävä



Sobald die Sonne untergeht, darf eine innovative Außenbeleuchtung nicht fehlen. Ein gut beleuchteter Außenbereich bietet nicht nur Sicherheit, sondern dient der Orientierung und schafft Atmosphäre rund um Ihr zu Hause. Außenleuchten sollten hohe Qualitätsanforderungen erfüllen, um den unterschiedlichen Bedingungen wie Feuchtigkeit, Regen, Schnee sowie jahreszeitlich bedingten Temperaturschwankungen unbeschadet standzuhalten. Unsere Außenleuchten werden in hochwertigem Aluminium-Druckguss gefertigt und versprechen Betriebssicherheit während der gesamten Lebensdauer, bei jeder Witterung, 365 Tage im Jahr. Moderne LED-Technologie sorgt darüber hinaus für gute Beleuchtungsqualität und hohe Energieeffizienz. Wir wünschen Ihnen viel Freude mit unser neuen Outdoor-Kollektion.

As soon as the sun goes down innovative outside lighting is a must. Well lit outdoor areas do not only provide security, but are an orientation guide and create atmosphere around your home. Outdoor lighting should fulfil high quality standards to withstand diverse conditions such as dampness, rain, snow and seasonal variations in temperature. Our outdoor lamps are produced in high-quality diecast aluminium and promise operational reliability for their entire life cycle, in all weathers, 365 days a year. Modern LED technology also provides a high level of both light quality and

sont fabriqués en aluminium moulé sous pression de haute qualité et garantissent une sécurité de fonctionnement pendant toute leur durée de vie, par tous les temps, 365 jours par an. La technologie LED moderne assure en outre une bonne qualité d'éclairage et une haute efficacité énergétique. Nous vous souhaitons beaucoup de satisfaction avec notre nouvelle collection d'extérieur.

Zodra de zon ondergaat, mag een innovatieve buitenverlichting niet ontbreken. Een goed verlichte buitenzone biedt niet alleen veiligheid, maar is goed voor de oriëntatie en scheidt sfeer rond uw huis. Buitenlichten moeten voldoen aan hoge kwaliteitsvereisten om bestand te zijn tegen diverse omstandigheden zoals vocht, regen, sneeuw alsook van het seizoen afhangelende temperatuurschommelingen. Onze buitenlichten worden uit hoogwaardig aluminium gegoten en beloven een veilige werking tijdens hun volledige levensduur, bij alle weersomstandigheden, 365 dagen per jaar. Moderne ledtechnologie zorgt daarnaast voor een goede verlichtingskwaliteit en hoge energie-efficiëntie. We wensen u veel plezier met onze nieuwe collectie voor buiten.

Tan pronto como se pone el sol, no debe faltar una iluminación exterior innovadora. Una zona exterior bien iluminada no solo ofrece seguridad, sino que también

Non appena il sole tramonta, l'illuminazione esterna innovativa è un must. Un'area esterna ben illuminata non solo garantisce la sicurezza ma funge anche da mezzo di orientamento e crea una piacevole atmosfera intorno alla vostra casa. Le lampade per esterni devono soddisfare elevati requisiti in termini di qualità per resistere, senza subire danni, alle varie condizioni climatiche come umidità, pioggia, neve e fluttuazioni stagionali della temperatura. Le nostre lampade per esterni sono prodotte in alluminio pressofuso di alta qualità e garantiscono affidabilità operativa durante tutto il loro ciclo di vita, in qualsiasi condizione atmosferica, 365 giorni all'anno. La moderna tecnologia LED garantisce inoltre una buona qualità dell'illuminazione e un'elevata efficienza energetica. Vi auguriamo il massimo del piacere con la nostra nuova Collezione Outdoor.

De îndată ce soarele apune, un sistem inovator de iluminat exterior nu trebuie să lipsească. Un spațiu exterior bine iluminat nu oferă numai securitate, ci are și rolul de a asigura orientarea și de a crea o atmosferă plăcută în jurul casei. Lămpile exterioare trebuie să îndeplinească cerințe înalte de calitate, pentru a rezista fără deteriorări la acțiunea diferitelor condiții de mediu, precum umiditatea, ploaia, ninsoarea, precum și fluctuațiile sezoniere de temperatură. Lămpile noastre exterioare sunt produse din aluminiu turnat sub presiune

korkeat laatuvaatimukset, jotta ne kestävät erilaisia olosuhteita, kuten kosteutta, sadetta, lunta ja vuodenaikojen lämpötilanvaihteluita ilman vaurioita. Ulkovalaisimet valmistetaan korkealaatuisesta painevaltusta alumiinista, ja ne takaavat varman toiminnan koko käyttöikänsä ajan säästä riippumatta, 365 päivää vuodessa. Moderni LED-tekniikka varmistaa myös hyvän valaistuksen laadun ja korkean energiatehokkuuden. Toivomme, että uusi ulkovalaisinmallistomme tuottaa sinulle paljon iloa.

Gdy tylko zachodzi słońce, nie powinno zabraknąć innowacyjnego oświetlenia zewnętrznego. Dobrze oświetlone miejsce na zewnątrz nie tylko zapewnia bezpieczeństwo, ale także służy orientacji w terenie i tworzy atmosferę wokół domu. Oświetlenie zewnętrzne powinno spełniać wysokie wymagania jakościowe, aby bez uszkodzeń sprostać różnym warunkom, tj. wilgoć, deszcz, śnieg i sezonowe wahania temperatury. Nasze lampy zewnętrzne są produkowane z wysokiej jakości odlewane aluminium i zapewniają niezawodność działania przez cały okres użytkowania, bez względu na pogodę, 365 dni w roku. Nowoczesna technologia LED zapewnia również dobrą jakość oświetlenia i wysoką efektywność energetyczną. Życzymy Państwu wiele radości z korzystania z naszej nowej kolekcji oświetlenia zewnętrznego.



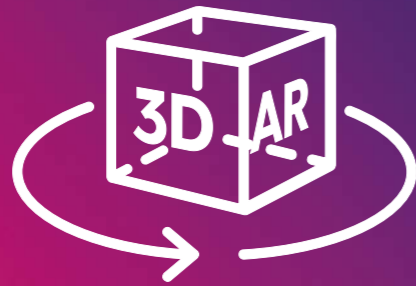

**3D und AR – entdecken Sie unsere Leuchten aus einem neuen Blickwinkel!**

**3D and AR – 3D and AR - Discover our luminaires from a new angle!**



### **Augmented Reality – mit dem Smartphone oder Tablet direkt in Ihr Zuhause!**

Augmented Reality – kurz AR – steht für „erweiterte Realität“. Durch unsere moderne AR-Funktion können Sie die „reale Welt“ mit unseren virtuellen Leuchten verbinden und diese bereits vorab digital in 3D in Ihrem Zuhause ausprobieren. Platzieren Sie die ausgewählte Leuchte virtuell an Ihrem gewünschten Ort und machen Sie sich ein Bild davon, ob z.B. die Stehleuchte zu Ihrem Wohnkonzept passt. Wie unsere AR-Funktion funktioniert? Ganz simpel ohne App und ohne großen Aufwand! Zum Ausspielen unserer digitalen Leuchte benötigen Sie ein Smartphone oder ein Tablet mit einer Kamera. Bei dem gewünschten Produkt finden Sie einen QR-Code, den Sie mit Ihrer Kamera einscannen. Nachdem Sie dem QR-Code-Link gefolgt sind und Ihre Umgebung anhand Ihrer Kamera erfasst wurde, wird Ihnen die gewünschte Leuchte dreidimensional in Ihren eigenen vier Wänden angezeigt. Nun können Sie unser Produkt detailliert und von allen Blickwinkeln an Ihrem Wunschort betrachten. Überzeugen Sie sich spätestens jetzt von unseren Leuchten!

### **Augmented Reality - get a feeling of our luminaires in your home using your smartphone or tablet**

Augmented Reality - AR for short - allows you to extend the boundaries of reality. Thanks to our modern AR function, you can connect the „real world“ to our virtual luminaires and try them digitally in 3D in your home before you buy them. Place the selected luminaire virtually in your desired location and get an idea of whether, for example, the floor lamp fits your living concept. Curious how our AR function works? To put it in simple words: without any app and without much effort! To see our digital luminaires, all you need is a smartphone or tablet with a camera. At the desired product you will find a QR code that you scan with your camera. After you have followed the QR code link and once your surroundings have been captured using your camera, the luminaire of your choice will be displayed three-dimensionally in your own place. This lets you view our product in detail and from all angles at your desired location. Convince yourself of our luminaires right now!



**SAMBESI  
504160142**



**TUELA  
210869124**



### **Mit der 3D-Funktion auf Herz und Nieren prüfen**

Durch unsere dreidimensionale Funktion können Sie unsere Leuchten realitätsnah von allen Seiten betrachten und sich ein eigenes Bild zu unserem Sortiment machen. Entdecken Sie die filigranen Details unserer Produkte schnell und simpel mit wenigen Klicks.

### **Putting it through its paces using the 3D function**

Thanks to our three-dimensional function, you can view our luminaires realistically from all sides and shape your own impression of the product range we offer. Discover the intricate details of our products quickly and easily with just a few clicks.

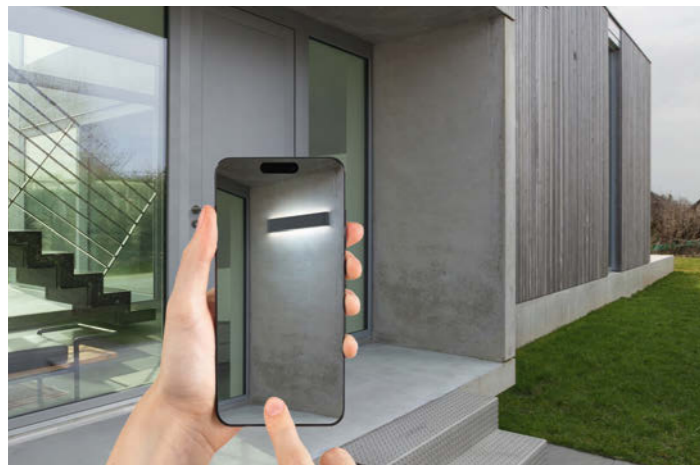

### Realità aumentata - per provare la sensazione delle nostre lampade nella tua casa usando il tuo smartphone o tablet

La realtà aumentata - AR in breve - permette di estendere i confini della realtà. Grazie alla nostra moderna funzione AR, puoi collegare il „mondo reale“ alle nostre lampade virtuali e provarle digitalmente in 3D nella tua casa prima di acquistarle. Posiziona virtualmente la lampada scelta nella posizione desiderata e fatti un'idea se, per esempio, la lampada a piantana, si adatta al tuo concetto abitativo. Curioso di sapere come funziona la nostra funzione AR? In parole povere: senza alcuna app e senza molto sforzo! Per vedere le nostre lampade digitali, tutto ciò che serve è uno smartphone o un tablet con una fotocamera. Sul prodotto desiderato troverai un codice QR da scansionare con la tua fotocamera. Dopo aver seguito il link del codice QR e una volta che l'ambiente circostante è stato catturato con la fotocamera, l'apparecchio di illuminazione di tua scelta sarà visualizzato tridimensionalmente nel tuo ambiente. Questo ti permette di vedere il nostro prodotto in dettaglio e da tutte le angolazioni nel luogo che desideri. Convinciti subito delle nostre lampade!

### Réalité augmentée - Ayez un avant-goût de nos luminaires chez vous à l'aide de votre smartphone ou de votre tablette

La Réalité Augmentée - RA en abrégé - vous permet de repousser les frontières de la réalité. Grâce à notre fonction moderne de réalité augmentée, vous pouvez vous connecter le « monde réel » à nos luminaires virtuels et les essayer numériquement en 3D chez vous avant de les acheter. Placez le luminaire sélectionné virtuellement dans l'endroit souhaité et faites-vous une idée de si, par exemple, le lampadaire s'intègre à votre salon. Curieux de savoir comment notre RA fonctionne ? Pour le dire simplement : sans application et sans trop d'effort ! Pour voir nos luminaires numériques, tout ce dont vous avez besoin c'est d'un smartphone ou d'une tablette avec appareil photo. Sur le produit souhaité, vous trouverez un QR code que vous scannez avec votre appareil photo. Après avoir suivi le lien du QR code et une fois que vos environnements ont été capturés à l'aide de votre appareil photo, le luminaire de votre choix sera affiché en trois dimensions dans votre propre endroit. Cela vous permet de voir notre produit en détail et depuis tous les angles dans l'endroit souhaité. Laissez-vous tout de suite séduire par nos luminaires!

### Augmented Reality - krijg een idee over onze lampen in uw huis via uw smartphone of tablet

Augmented Reality - AR afgekort - staat u toe de grenzen van de realiteit te verlengen. Dankzij onze moderne AR-functie kunt u de „echte wereld“ verbinden met onze virtuele lampen en ze digitaal in 3D uitproberen bij u thuis voordat u ze koopt. Plaats de geselecteerde lamp virtueel op uw gewenste locatie and krijg een idee of bijvoorbeeld de staande lamp past binnen uw leefconcept. Benieuwd hoe onze AR-functie werkt? Om het eenvoudig te stellen: zonder app en zonder veel moeite! Al wat u nodig hebt om onze digitale lampen te bekijken, is een smartphone of tablet met een camera. Bij het gewenste product vindt u een QR-code die u met uw camera scant. Nadat u de QR-code link gevolgd hebt en eens uw omgeving via uw camera vastgelegd werd, wordt de lamp van uw keuze driedimensionaal in uw eigen ruimte weergegeven. Dit laat u ons product in detail en vanuit alle hoeken op uw gewenste locatie bekijken. Overtuig uzelf nu van onze lampen!

### Realidad aumentada: hágase a la idea de cómo quedan nuestras lámparas en su hogar mediante su teléfono inteligente o su tableta

La realidad aumentada le permite ampliar los límites de la realidad. Gracias a nuestra moderna función de realidad aumentada, tiene la posibilidad de conectar nuestras lámparas virtuales con el „mundo real“ y probarlas de manera digital en 3D en su hogar antes de comprarlas. Coloque virtualmente la lámpara seleccionada en la ubicación deseada y compruebe si, por ejemplo, una lámpara de pie encaja con la estética de su salón. ¿Cómo funciona nuestra función de realidad aumentada? En unas sencillas palabras: sin requerir ninguna aplicación ni esfuerzo. Lo único que necesita para ver nuestras lámparas es un teléfono inteligente o una tableta con cámara. El producto que seleccione contará con un enlace de código QR que puede escanear con su cámara. Después de acceder al enlace del código QR y una vez que haya capturado el entorno con la cámara, se mostrará la lámpara seleccionada en tres dimensiones en su propio hogar. Esto le permite ver nuestros productos al detalle y desde todos los ángulos en la ubicación que desee. Convéngase de elegir nuestras lámparas usted mismo.

### Realitatea augmentată - faceți-vă o idee despre corpurile noastre de iluminat în căminul dvs., folosind un smartphone sau o tabletă

Realitatea augmentată - AR, pe scurt - vă permite să extindeți limitele realității. Datorită funcției AR moderne, puteți conecta „lumea reală“ la corpurile noastre de iluminat virtuale și le puteți testa digital în format 3D acasă, înainte de a le cumpăra. Amplasați virtual corpul de iluminat selectat în locul dorit și vedeți aproximativ, de exemplu, dacă lampadarul se potrivește în conceptul camerei de zi. Sunteți curioși să știți cum funcționează AR? Pe scurt: fără nicio aplicație și fără prea mult efort! Pentru a vedea corpurile noastre de iluminat digitale aveți nevoie doar de un smartphone sau o tabletă cu cameră. La produsul dorit găsiți un cod QR pe care îl scanați cu camera. După ce accesați linkul de la codul QR și după ce sunt înregistrate înregistrările folosind camera, corpul de iluminat selectat este afișat tridimensional în propria dvs. locuință. Astfel puteți vedea produsul în detaliu, din toate unghiurile, în locul ales de dvs. Convingeți-vă chiar acum în legătură cu corpurile noastre de iluminat!

### Lisätty todellisuus - kokeile valaisimiamme kotonasi älypuhelimien tai tabletin avulla

Lisätty todellisuus - lyhennettynä AR (augmented reality) - antaa mahdollisuuden laajentaa todellisuuden rajoja. Nykyaikaisen AR-toimintomme ansiosta voit yhdistää „oikean maailman“ virtuaalivalaisimiimme ja kokeilla niitä digitaalisesti 3D:nä kotonasi ennen ostopäätöstä. Aseta valitut valaisimet virtuaalisesti haluttuun paikkaan ja saat suuriin kuvan siitä, sopiiko esimerkiksi lattialamppu olohuoneeseesi. Kiinnostaako, kuinka AR-toimintomme toimii? Yksinkertaistetusti: ilman sovelluksia ja turhaa vaivannäköä! Nähdäksesi valaisimemme tarvitset ainoastaan kamerallisen älypuhelimien tai tabletin. Halutun tuotteen kohdalta löydät QR-koodin, jonka voit lukea kamerallasi. Kun olet seurannut QR-koodin linkkiä ja kun ympäristösi on tallennettu kameraasi käyttäen, haluamasi valaisin näkyy kolmiulotteisena omassa kodissasi. Näin pystyt tutustumaan tuotteisiimme yksityiskohtaisesti ja kaikista vinkkeleistä haluamassasi paikassa. Anna valaisimemme vakuuttaa sinut!

### Rozszerzona rzeczywistość – zobacz nasze oprawy w swoim domu za pomocą smartfona lub tabletu

Rozszerzona rzeczywistość (augmented reality – AR) pozwala poszerzać granice rzeczywistości. Dzięki naszej nowoczesnej funkcji AR możesz połączyć rzeczywisty świat z naszymi wirtualnymi oprawami i wypróbować je cyfrowo w 3D w swoim domu, zanim je kupisz. Umieść oprawę wirtualnie w wybranym miejscu i przekonaj się, czy np. lampa podłogowa pasuje do Twojej koncepcji mieszkania.

Ciekawi Cię, jak działa nasza funkcja AR? Krótko mówiąc: bez żadnej aplikacji i bez większego wysiłku! Aby zobaczyć nasze cyfrowe oprawy, wystarczy smartfon lub tablet z aparatem. Przy wybranym produkcie znajdziesz kod QR, który zeskanujesz aparatem. Po kliknięciu linku z kodem QR i uchwyceniu otoczenia za pomocą aparatu, wybrana przez Ciebie oprawa zostanie wyświetlona w trzech wymiarach w Twoim pokoju. Dzięki temu możesz obejrzeć nasz produkt szczegółowo i pod każdym kątem w wybranym miejscu. Przekonaj się już teraz o naszych oprawach!

**3D et RA - Découvrez nos luminaires depuis un nouvel angle!**

**3D en AR - Ontdek onze lampen vanuit een nieuwe hoek!**

**3D y realidad aumentada: descubra nuestras lámparas con una nueva perspectiva.**

**3D e AR - Scopri le nostre lampade da una nuova angolazione!**

**3D și AR - Descoperiți corpurile noastre de iluminat dintr-un alt unghi!**

**3D ja AR - Tutustu valaisimiimme uudesta vinkkelistä!**

**3D i AR – Odkryj nasze oprawy z nowej perspektywy!**

### Mise à l'épreuve à l'aide de la fonction 3D

Grâce à notre fonction à trois dimensions, vous pouvez voir nos luminaires de façon réaliste de tous les côtés et vous faire votre propre idée de la gamme de produits que nous proposons. Découvrez rapidement et facilement les détails complexes de nos produits en seulement quelques clics.

### Het grondig testen via de 3D-functie

Dankzij onze driedimensionale functie kunt u onze lampen realistisch bekijken van alle gezichtspunten en uw eigen indruk vormen van het productgamma dat we aanbieden. Ontdek snel en makkelijk de complexe details van onze producten via slechts enkele malen klikken.

### Pórgalas a prueba con las funciones 3D

Gracias a nuestra función tridimensional, puede tener una visualización realista de nuestras lámparas desde todos los ángulos y hacerse una idea propia de la gama de productos que ofrecemos. Descubra los intrincados detalles de nuestros productos de forma rápida y sencilla en solo unos clics.

### Mettila alla prova con la funzione 3D

Grazie alla nostra funzione tridimensionale, puoi osservare le nostre lampade in modo realistico da tutti i lati e farti un'idea personale della gamma di prodotti che offriamo. Scopri i dettagli intricati dei nostri prodotti in modo rapido e semplice con pochi clic.



**LENNON  
R52176102**



**FUERTE  
526260142**







# Serienübersicht · Family overview

Aperçu par famille · Overzicht per familie · Vista general por familia · Panoramica per famiglia ·  
Prezentare pe familii de produse · Perheen yleiskuvaus · Przegląd rodziny



ADAJA	60	ROYA	46	ARUBA	156
ARDAS	61	SACRAMENTO	62	BOLO	160
ARDILA	88	SAMBESI	112	CAMARO	144
AVON	18	SHANNON	32	CAMPUS	183
BELAJA	126	TANARO	118	CARMO	164
BELLY	52	TAWA	53	CORDOBA	136
BREG	84	TAY	59	CORO	180
BRENTA	122	THAMES	55	COTOCA	177
CANNING	104	THAMES II	56	DORA	158
CAVADO	116	TIBER	72	ELLIOT	154
CLYDE	73	TIMOK	82	ESQUEL	168
COLORADO	54	TRAVE	64	FERNANDEZ	153
COOPER	102	TRENT	58	FOMOSA	170
CUANDO	68	TUELA	120	GARCIA	173
CUBANGO	98	TUNGA	74	JAMAICA	157
DUERO	125	UBANGI	128	KENDAL	142
FUERTE	22	WITHAM	66	LAREDO	135
GANGES	28	YANGTZE	70	LENNON	155
GARONNE	106			LIMEIRA	139
HONDO	83			LOJA	181
HOOSIC	90			LORA	159
HORTON	42			MAIRANA	176
HUDSON	96			MARTINEZ	152
INDUS	69			MELO	182
KASAI	81			MENDOZA	170
KAVERI	50			MERIDA	179
KONDA	63			MINEROS	174
LOGONE	24			MOLINA	138
LUNGA	110			MORENA	141
MAREB	129			PALMAS	148
MERSEY	79			POSADAS	166
MITCHELL	71			PUELO	145
MUGA	78			PUNO	134
NELSON	38			ROSARIO	137
NESTOS	16			SANCHEZ	150
NORMAN	100			SALTA	171
OHIO	65			SANTANA	175
OLONA	124			SILVA	172
PEARL	34			SONORA	178
PECOS	80			VENADO	140
PEDRO	85				
PIAVE	86				
RENO	26				
RHINE	30				

# Produktübersicht · Product Overview

Aperçu des produits · Productoverzicht · Descripción del producto ·  
Panoramica prodotto · Vizualizare produs · Tuotteen yleiskuvaus · Przegląd produktów



AVON  
20



FUERTE  
22



RHINE  
30



WITHAM  
66



SHANNON  
32



PUNO  
134



ARDILA  
88



HOOSIC  
94



HUDSON  
96



MOLINA  
138



MOLINA  
138

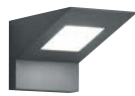

NELSON  
40



GANGES  
28



PEARL  
36



TAWA  
51



NESTOS  
16



YANGTZE  
70



MITCHELL  
71



INDUS  
69



TIMOK  
82



PECOS  
80



MUGA  
78

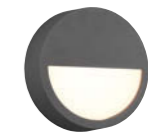

PEDRO  
85



CUANDO  
68



HORTON  
44



TRAVE  
64



THAMES  
55



THAMES II  
56



KONDA  
63



KENDAL  
142



BELLY  
52



HONDO  
83



TRAVE  
64



BREG  
84



TRENT  
58



LOGONE  
24



COLORADO  
54



TAY  
59



SACRAMENTO  
62



KENDAL  
142



CAMARO  
144



VENADO  
140



MORENA  
141



CUBANGO  
98



TUELA  
120



RENO  
26



COOPER  
102



CLYDE  
73



ROYA  
48



TIBER  
72



KAVERI  
50



CANNING  
104



GARONNE  
106



GARONNE  
108

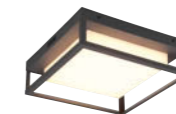

WITHAM  
66



SAMBESI  
112



TANARO  
118



TUNGA  
76



ADAJA  
60



CORDOBA  
136



ROSARIO  
137



ARDAS  
61



LUNGA  
110



OLONA  
124



CAVADO  
116



DUERO  
125



BRENTA  
122



BRENTA  
123

# Sicherheit & Komfort / Sensorleuchten · Security & Comfort / Sensor Lights

Sécurité et confort / Lampes à détecteur · Veiligheid en comfort/sensorklampen · Seguridad & Comodidad / Luces del sensor ·  
Sicurezza e comfort / Lampade con sensore integrat · Siguranță & confort / Lumini senzori ·  
Turvallisuus ja mukavuus/tunnistinvalaisimet · Bezpieczeństwo i komfort / światła z czujnikami

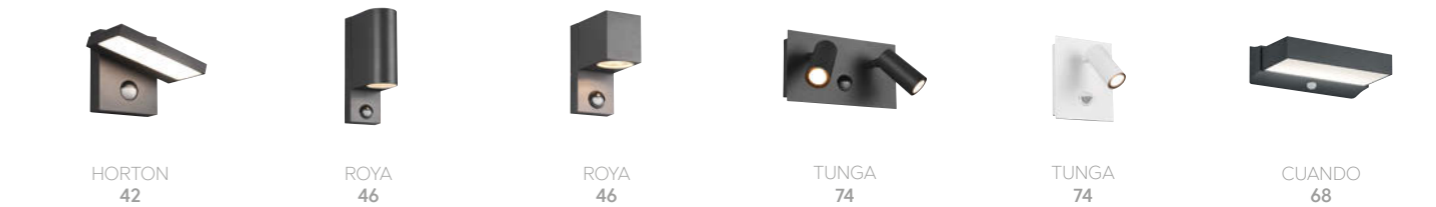
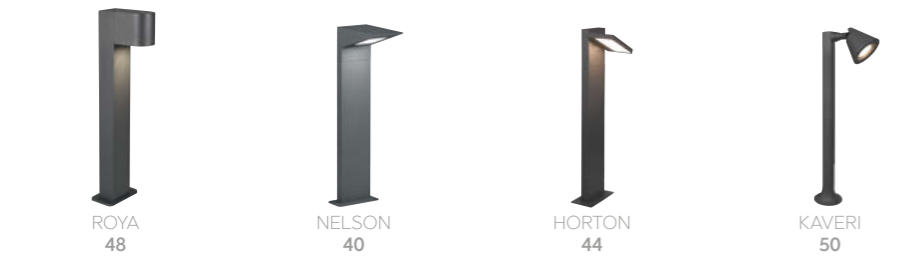



## Spots, Einbauleuchten & Zubehör ·

### Spotlights, Recessed luminaires & Accessories

Spots, lumières encastrées et accessoires · Spots, inbouwlampen en toebehoren · Puntos de luz, lámparas integradas y accesorios · Faretto, lampade da incasso e sensori · Spoturi, lămpi încorporate & accesorii · Kohdevalaisimet, upotettavat valaisimet ja tarvikkeet · Spoty, światła wpuszczane i akcesoria



TUNGA  
74



BELAJA  
127



BELAJA  
126



MAREB  
129



UBANGI  
128



ERDSPIESS  
GROUND SPIKE  
132



ECKHALTERUNG  
CORNER FASTENING  
133



STECKDOSEN  
PLUG  
130



STECKDOSEN  
PLUG  
130



STECKDOSEN  
PLUG  
131

## Outdoor Living · Outdoor Living Lighting

Idées d'éclairage pour la vie en plein air · Lichtideeën voor buiten · Ideas de luz para la vida al aire libre · Idee di Illuminazione per l'Outdoor Living · Idei de iluminaare pentru exterior · Outdoor Living -valaisinideat · Pomysły na oświetlenie zewnętrzne



ARUBA  
156



JAMAICA  
157



PALMAS  
148



DORA  
158



LORA  
159



ELLIOT  
154



LENNON  
155



SANCHEZ  
151



FERNANDEZ  
153



MARTINEZ  
152



BOLO  
160



CARMO  
164



POSADAS  
166



ESQUEL  
168



MENDOZA  
170



FOMOSA  
170



SALTA  
171



CARMO  
164



POSADAS  
166



ESQUEL  
168



SILVA  
172



GARCIA  
173



MINEROS  
174



CORO  
180



LOJA  
181



MAIRANA  
176



COTOCA  
177



SANTANA  
175



SONORA  
178



MERIDA  
179



MERIDA  
179



MELO  
182



CAMPUS  
183

## Solarleuchten · Solar Lights

Lampes solaires · Lampen op zonne-energie · Luces solares · Lampade solari · Lămpi solare · Aurinkovalaisimet · Światła z zasilaniem słonecznym



# NESTOS

Aluminium Druckguss, Kunststoff  
 diecast aluminium, plastic  
 fonte d'aluminium, plastique  
 gegoten aluminium, kunststof  
 aluminio fundido, plástico  
 pressofusione di alluminio, plastica  
 fonta aluminiu, plastic  
 valualumiini, muovi  
 barwione aluminium, plastik

**42 Anthrazit · anthracite**

Incl. 1 x SMD-LED, 13 W  
 1.300 lm, 3.000 K

**240960142**

**IP54**

Incl. 1 x SMD-LED, 13 W  
 1.300 lm, 3.000 K

**240969142**

**440969142**

**540969142**

**IP54**

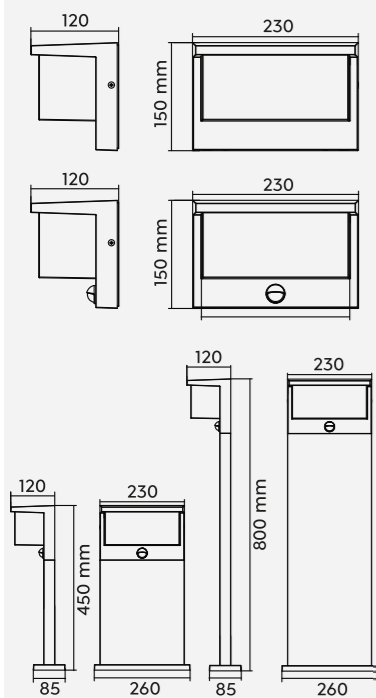

**240960142**



**240969142**



**440969142**



**540969142**

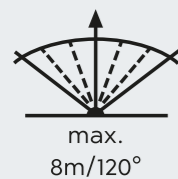



# AVON

Aluminium Druckguss, Acryl  
 diecast aluminium, acryl  
 fonte d'aluminium, acryl  
 gegoten aluminium, acryl  
 aluminio fundido, acrílico  
 pressofusione di alluminio, acrilico  
 fonta aluminiu, acrilic  
 valualumiini, akryyli  
 barwione aluminium, akryl

42 Anthrazit · anthracite

Incl. 1 x SMD-LED, 7 W  
 800 lm, 3.000 K

270669142  
 470669142  
 570669142



Incl. 2 x SMD-LED, 7 W  
 2 x 800 lm, 3.000 K

270669242

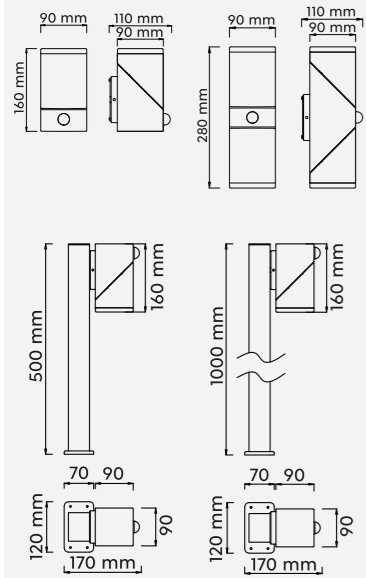

270669142

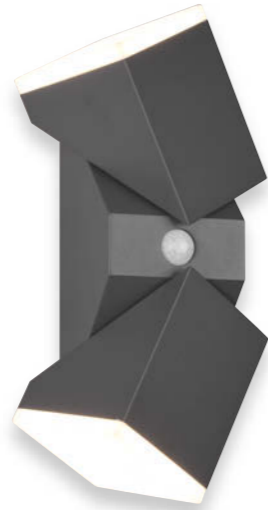

270669242



570669142



470669142

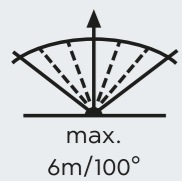

Die Leuchte verfügt über ein Orientierungslicht, das sich bei Dämmerung oder Dunkelheit automatisch einschaltet. Wird eine Bewegung erfasst, schaltet die Leuchte von Orientierungslicht auf volle Lichtleistung.

The luminaire has an orientation light that switches on automatically at dusk or in the dark. If movement is detected, the luminaire switches from orientation light to full light output.



Aluminium Druckguss, Acryl  
 diecast aluminium, acryl  
 fonte d'aluminium, acryl  
 gegoten aluminium, acryl  
 aluminio fundido, acrílico  
 pressofusione di alluminio, acrilico  
 fonta aluminiu, acrilic  
 valualumiini, akryyli  
 barwione aluminium, akryl

**42 Anthrazit · anthracite**

Incl. 1 x SMD-LED, 7 W  
 800 lm, 3.000 K

**270660142**  
**470660142**  
**570660142**



Incl. 2 x SMD-LED, 7 W  
 2 x 800 lm, 3.000 K

**270660242**

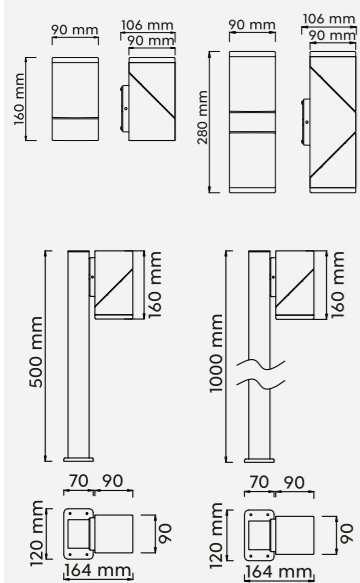

270660142

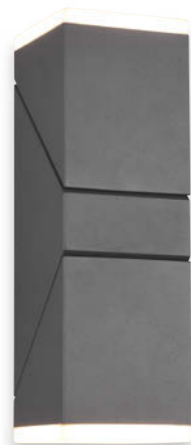

270660242



570660142



470660142





# FUERTE

Aluminium Druckguss, Acryl  
 diecast aluminium, acryl  
 fonte d'aluminium, acryl  
 gegoten aluminium, acryl  
 aluminio fundido, acrílico  
 pressofusione di alluminio, acrilico  
 fonta aluminiu, acrilic  
 valualumiini, akryyli  
 barwione aluminium, akryl

**42** Anthrazit · anthracite

Incl. 1 x SMD-LED, 10,5 W  
 1.300 lm, 3.000 K  
**226260142**

IP54

Incl. 1 x SMD-LED, 15 W  
 1.700 lm, 3.000 K  
**426260142**  
**526260142**

IP54



226260142



426260142



526260142

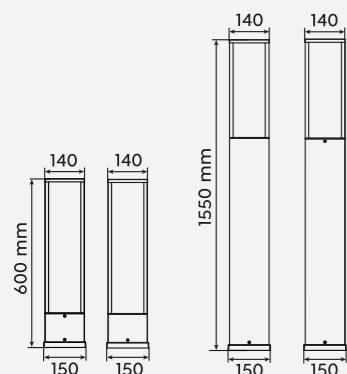
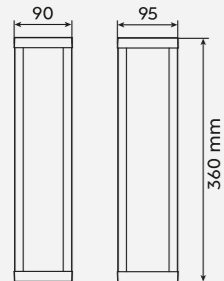



# LOGONE

Aluminium Druckguss  
diecast aluminium  
fonte d'aluminium  
gegoten aluminium  
aluminio fundido  
pressofusione di alluminio  
fonta aluminiu  
valualumiini  
barwione aluminium

42 Anthrazit · anthracite

Incl. SMD-LED, 11 W  
1.100 lm, 3.000 K

IP65

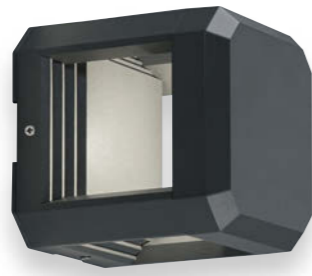
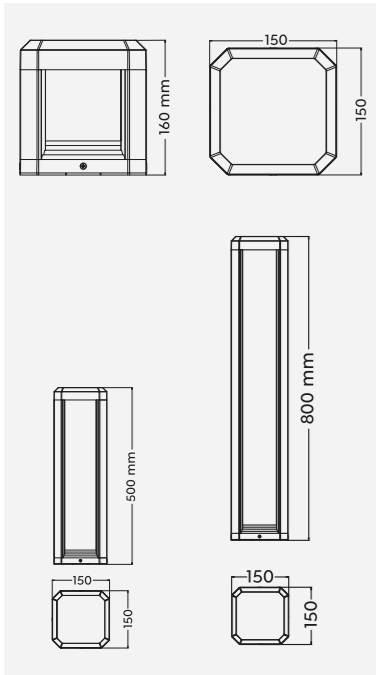

222360142



522360142



422360142

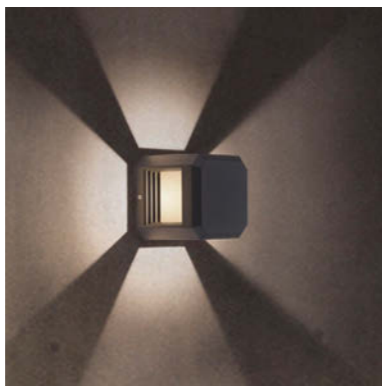



# RENO

Aluminium Druckguss  
diecast aluminium  
fonte d'aluminium  
gegoten aluminium  
aluminio fundido  
pressofusione di alluminio  
fonta aluminiu  
valualumiini  
barwione aluminium

42 Anthrazit · anthracite

Incl. 1 x COB-LED, 4,5 W  
450 lm, 3.000 K

IP54

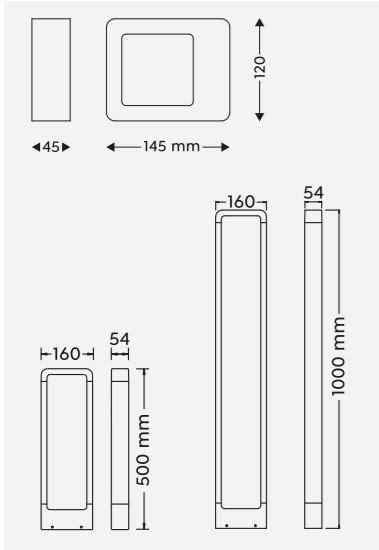

220760142



520760142



420760142

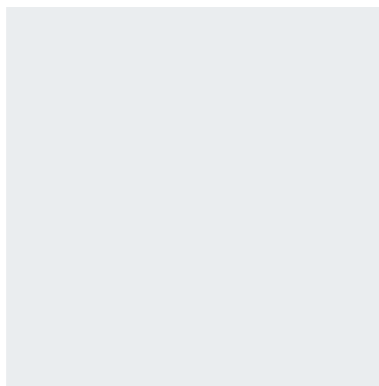

# GANGES

Aluminium Druckguss  
 diecast aluminium  
 fonte d'aluminium  
 gegoten aluminium  
 aluminio fundido  
 pressofusione di alluminio  
 fonta aluminiu  
 valualumiini  
 barwione aluminium

42 Anthrazit · anthracite

Incl. 1 x SMD-LED, 9 W  
 1.000 lm, 3.000 K

IP54

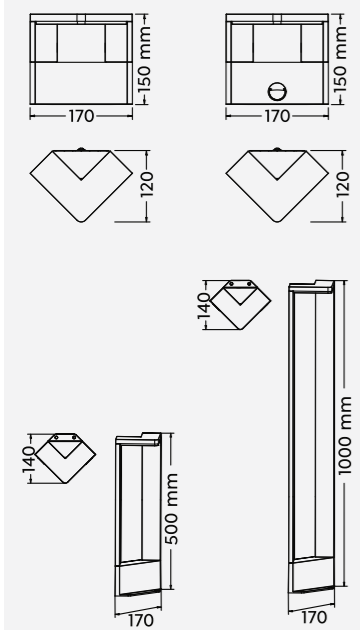

221760142



521760142



421760142



221769142



Bewegungssensor  
 Motion sensor  
 Détecteur de mouvement  
 Bewegungssensor  
 Sensor de movimiento  
 Sensore di movimento  
 Sensor de mişcare  
 Liiketunnistin  
 Czujnik ruchu

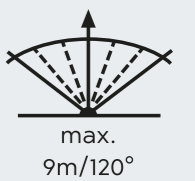



# RHINE

Aluminium Druckguss, Kunststoff  
 diecast aluminium, plastic  
 fonte d'aluminium, plastique  
 gegoten aluminium, kunststof  
 aluminio fundido, plástico  
 pressofusione di alluminio, plastica  
 fonta aluminiu, plastic  
 valualumiini, muovi  
 barwione aluminium, plastik

**42** Anthrazit · anthracite

Incl. 2 x SMD-LED, 4,5 W  
 2 x 600 lm, 3.000 K

**221660242**  
**221669242**

Incl. 2 x SMD-LED, 5,5 W  
 2 x 700 lm, 3.000 K

**421660242**  
**521660242**

IP54



221660242

221669242



521660242



421660242

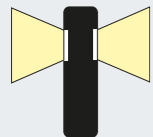
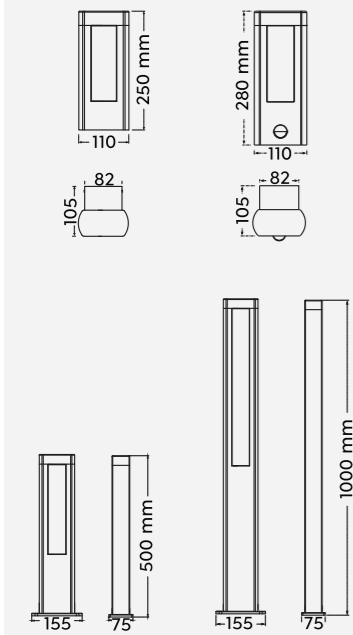

Bewegungssensor  
 Motion sensor  
 Détecteur de mouvement  
 Bewegungssensor  
 Sensor de movimiento  
 Sensore di movimento  
 Senzor de mişcare  
 Liiketunnistin  
 Czujnik ruchu

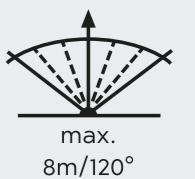



# SHANNON

Aluminium Druckguss, Kunststoff  
diecast aluminium, plastic  
fonte d'aluminium, plastique  
gegoten aluminium, kunststof  
aluminio fundido, plástico  
pressofusione di alluminio, plastica  
fonta aluminu, plastic  
valualumiini, muovi  
barwione aluminium, plastik

42 Anthrazit · anthracite

Incl. 1 x SMD-LED, 7,2 W  
660 lm, 3.000 K

IP54

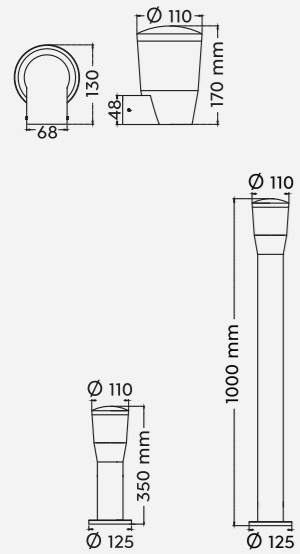

222060142



522060142



422060142





# PEARL

Aluminium Druckguss, Kunststoff  
 diecast aluminium, plastic  
 fonte d'aluminium, plastique  
 gegoten aluminium, kunststof  
 aluminio fundido, plástico  
 pressofusione di alluminio, plastica  
 fonta aluminiu, plastic  
 valualumiini, muovi  
 barwione aluminium, plastik

42 Anthrazit · anthacite

Incl. 1 x SMD-LED, 8 W  
 900 lm, 3.000 K

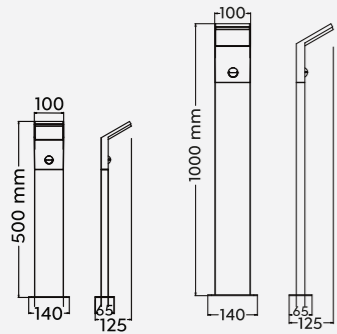
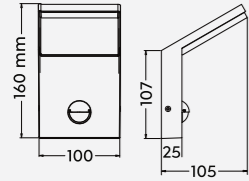

221169142



521169142



421169142

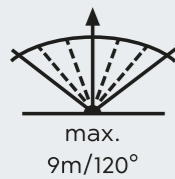

Bewegungssensor  
 Motion sensor  
 Détecteur de mouvement  
 Bewegungssensor  
 Sensor de movimiento  
 Sensore di movimento  
 Senzor de mișcare  
 Liiketunnistin  
 Czujnik ruchu





# PEARL

Aluminium Druckguss, Kunststoff  
diecast aluminium, plastic  
fonte d'aluminium, plastique  
gegoten aluminium, kunststof  
aluminio fundido, plástico  
pressofusione di alluminio, plastica  
fonta aluminu, plastic  
valualumiini, muovi  
barwione aluminium, plastik

42 Anthrazit · anthacite

Incl. 1 x SMD-LED, 8 W  
900 lm, 3.000 K

IP54



221160142



521160142



421160142

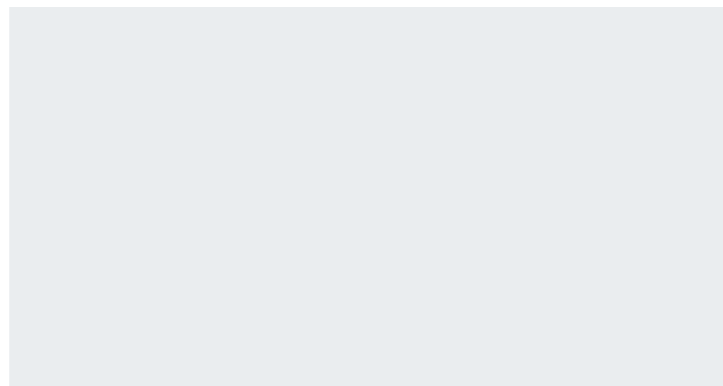
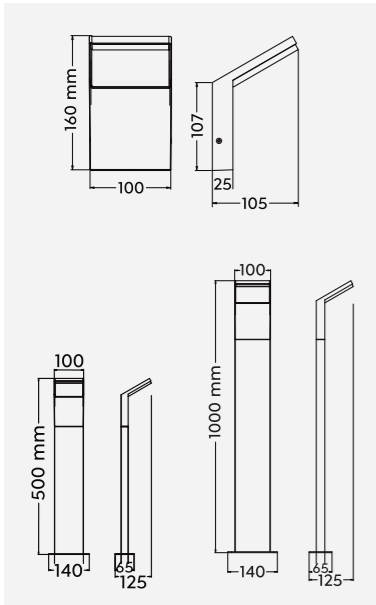



# NELSON

Aluminium Druckguss  
 diecast aluminium  
 fonte d'aluminium  
 gegoten aluminium  
 aluminio fundido  
 pressofusione di alluminio  
 fonta aluminiu  
 valualumiini  
 barwione aluminium

**42** Anthrazit · anthracite

Incl. 1 x SMD-LED, 8 W  
 900 lm, 3.000 K

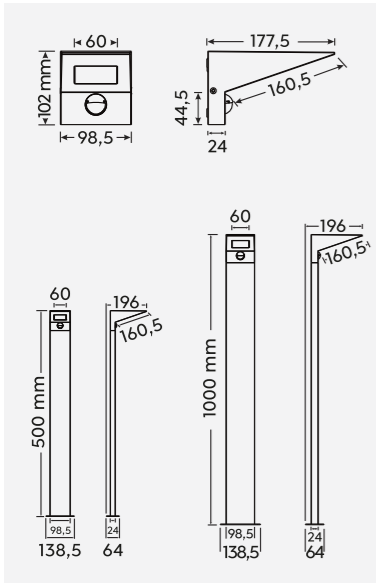

525369142



425369142



225369142

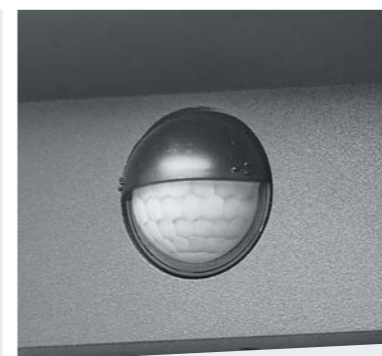

Bewegungssensor  
 Motion sensor  
 Détecteur de mouvement  
 Bewegungssensor  
 Sensor de movimiento  
 Sensore di movimento  
 Sensor de mişcare  
 Liiketunnistin  
 Czujnik ruchu

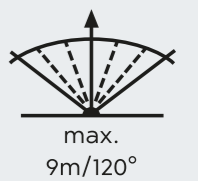



# NELSON

Aluminium Druckguss  
diecast aluminium  
fonte d'aluminium  
gegoten aluminium  
aluminio fundido  
pressofusione di alluminio  
fonta aluminiu  
valualumiini  
barwione aluminium

42 Anthrazit · anthracite

Incl. 1 x SMD-LED, 8 W  
900 lm, 3.000 K

IP54

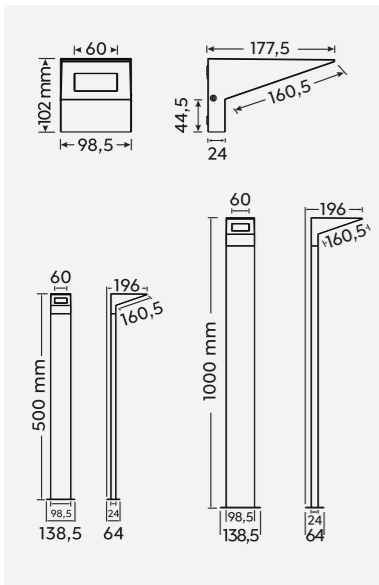

225360142



525360142



425360142

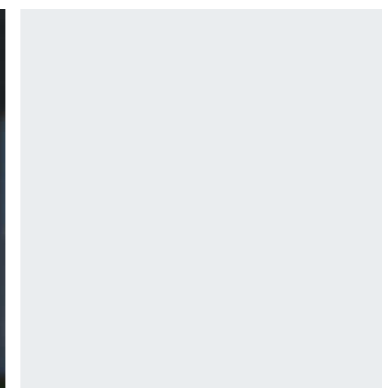



# HORTON

Aluminium Druckguss  
 diecast aluminium  
 fonte d'aluminium  
 gegoten aluminium  
 aluminio fundido  
 pressofusione di alluminio  
 fonta aluminiu  
 valualumiini  
 barwione aluminium

42 Anthrazit · anthracite

Incl. 1 x SMD-LED, 8 W  
 1.000 lm, 3.000 K

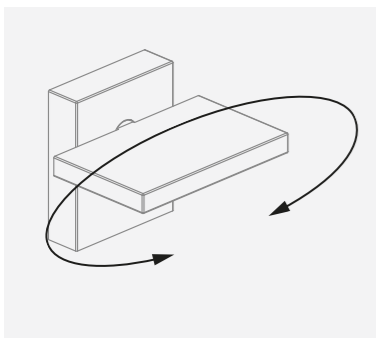
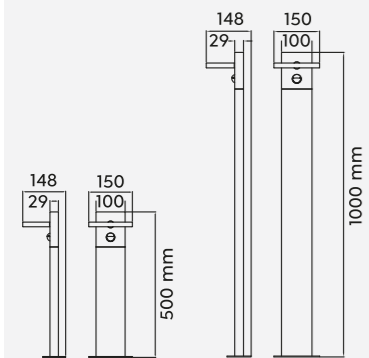
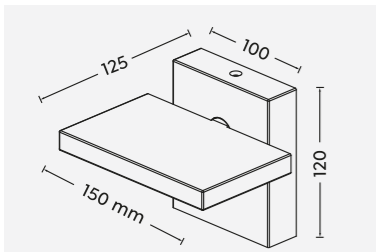

226369142



526369142

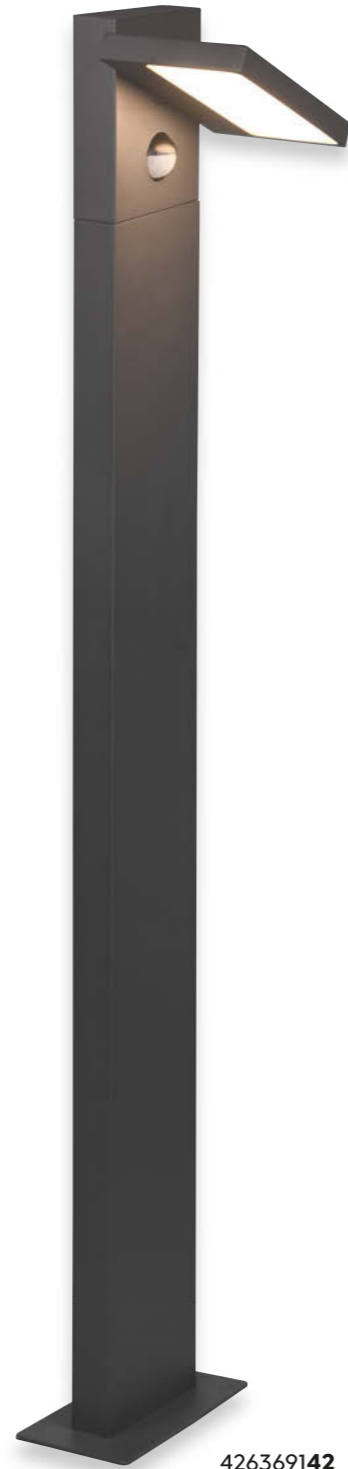

426369142

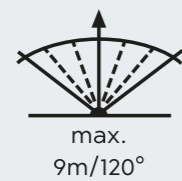

max.  
 9m/120°



Bewegungssensor  
 Motion sensor  
 Détecteur de mouvement  
 Bewegungssensor  
 Sensor de movimiento  
 Sensore di movimento  
 Senzor de mișcare  
 Liiketunnistin  
 Czujnik ruchu



# HORTON

Aluminium Druckguss  
 diecast aluminium  
 fonte d'aluminium  
 gegoten aluminium  
 aluminio fundido  
 pressofusione di alluminio  
 fonta aluminiu  
 valualumiini  
 barwione aluminium

**42** Anthrazit · anthracite

Incl. 1 x SMD-LED, 8 W  
 1.000 lm, 3.000 K

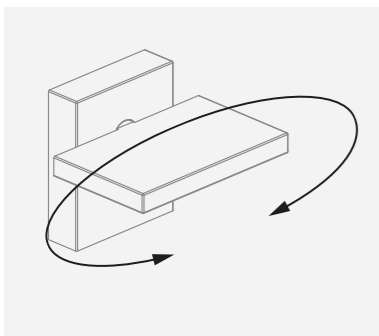
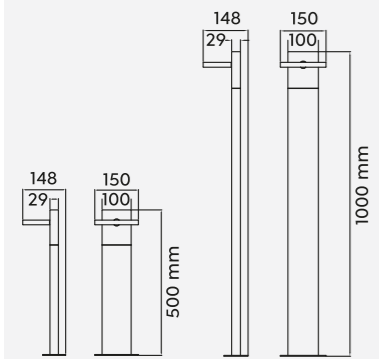
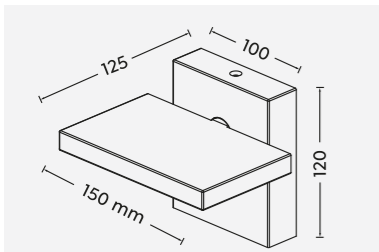

226360142



526360142

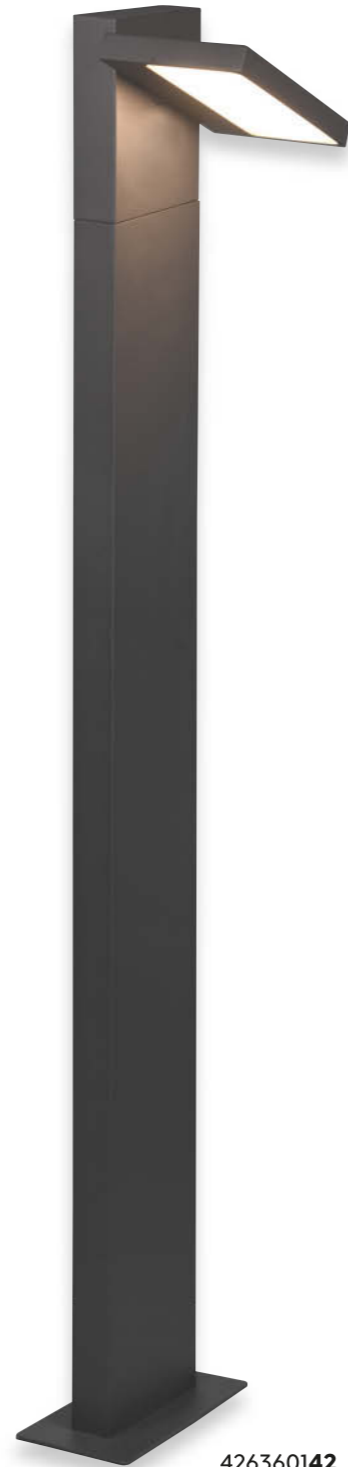

426360142

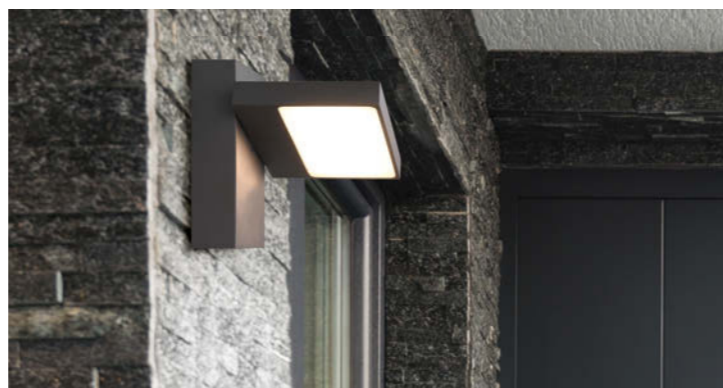



# ROYA

Aluminium Druckguss  
diecast aluminium  
fonte d'aluminium  
gegoten aluminium  
aluminio fundido  
pressofusione di alluminio  
fonta aluminiu  
valualumiini  
barwione aluminium

42 Anthrazit · anthracite

Excl. 1 x GU10, max. 35 W

214260142

214269142

414260142

514260142



Excl. 2 x GU10, max. 35 W

214260242

214269242

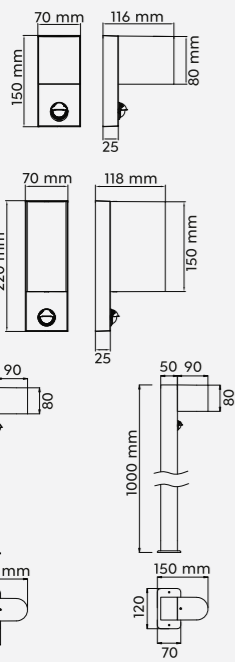

214260142



214269242



214269142



514260142



414260142



214260242

Empfohlen:  
recommended:

LED GU10, 5 W  
400 lm, 3.000 K  
± 110°



955-50

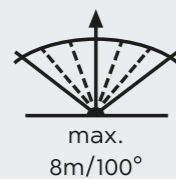

Bewegungssensor  
Motion sensor  
Détecteur de mouvement  
Bewegingssensor  
Sensor de movimiento  
Sensore di movimento  
Senzor de mișcare  
Liiketunnistin  
Czujnik ruchu



# ROYA

Aluminium Druckguss  
 diecast aluminium  
 fonte d'aluminium  
 gegoten aluminium  
 aluminio fundido  
 pressofusione di alluminio  
 fonta aluminiu  
 valualumiini  
 barwione aluminium

**24** rostfarbig · rusty  
**31** Weiß matt · white mat  
**42** Anthrazit · anthracite

Excl. 2 x GU10, max. 35 W

204260224  
 204269224  
 204260231  
 204269231  
 204260242  
 204269242



Excl. 1 x GU10, max. 35 W

404260142  
 504260142

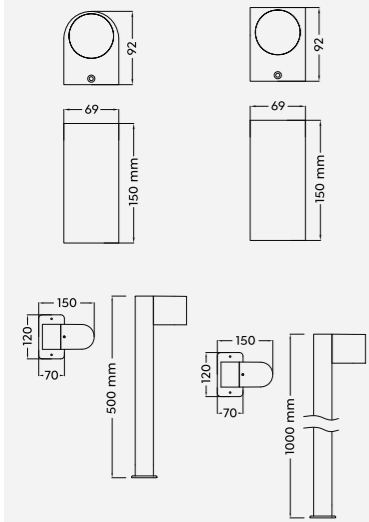

204260242



204269242



504260142



404260142



204260224



204260231



204269224



204269231

Empfohlen:  
 recommended:

LED GU10, 5 W  
 400 lm, 3.000 K  
 > 110°



955-50



# KAVERI

Aluminium Druckguss  
 diecast aluminium  
 fonte d'aluminium  
 gegoten aluminium  
 aluminio fundido  
 pressofusione di alluminio  
 fonta aluminiu  
 valualumiini  
 barwione aluminium

**42** Anthrazit · anthracite

Excl. 1 x GU10, max. 28 W

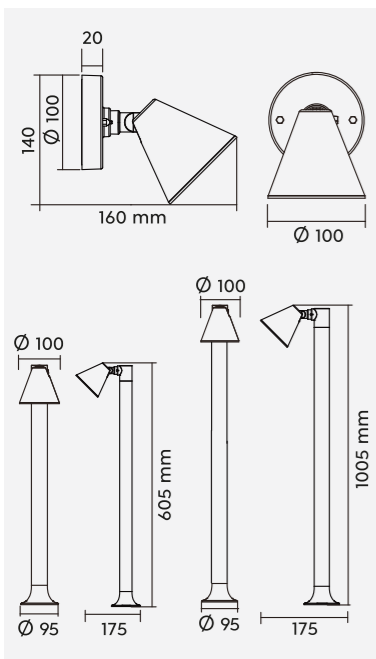

206060142

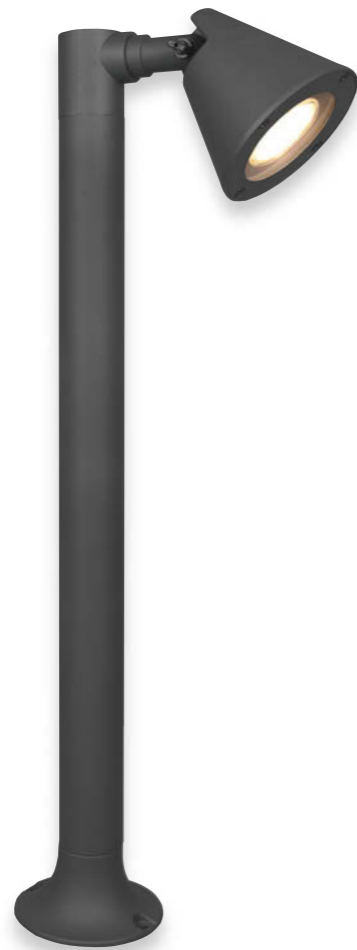

506060142

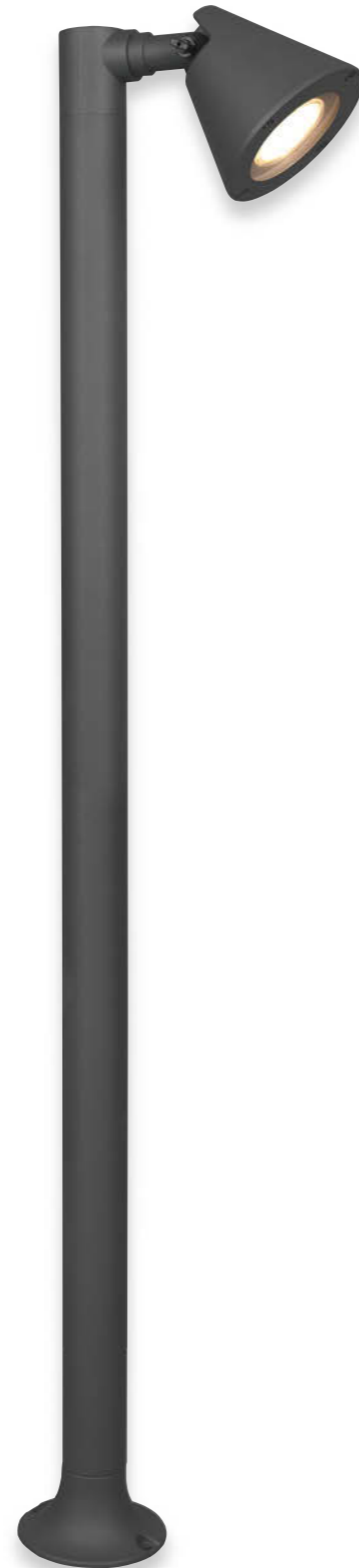

406060142

Empfohlen:  
 recommended:

LED GU10, 5 W  
 400 lm, 3.000 K  
 ≥ 110°



955-50





# BELLY

Aluminium Druckguss  
 diecast aluminium  
 fonte d'aluminium  
 gegoten aluminium  
 aluminio fundido  
 pressofusione di alluminio  
 fonta aluminiu  
 valualumiini  
 barwione aluminium

**42** Anthrazit · anthracite

Incl. 1 x SMD-LED, 8,5 W  
 850 lm, 3.000 K

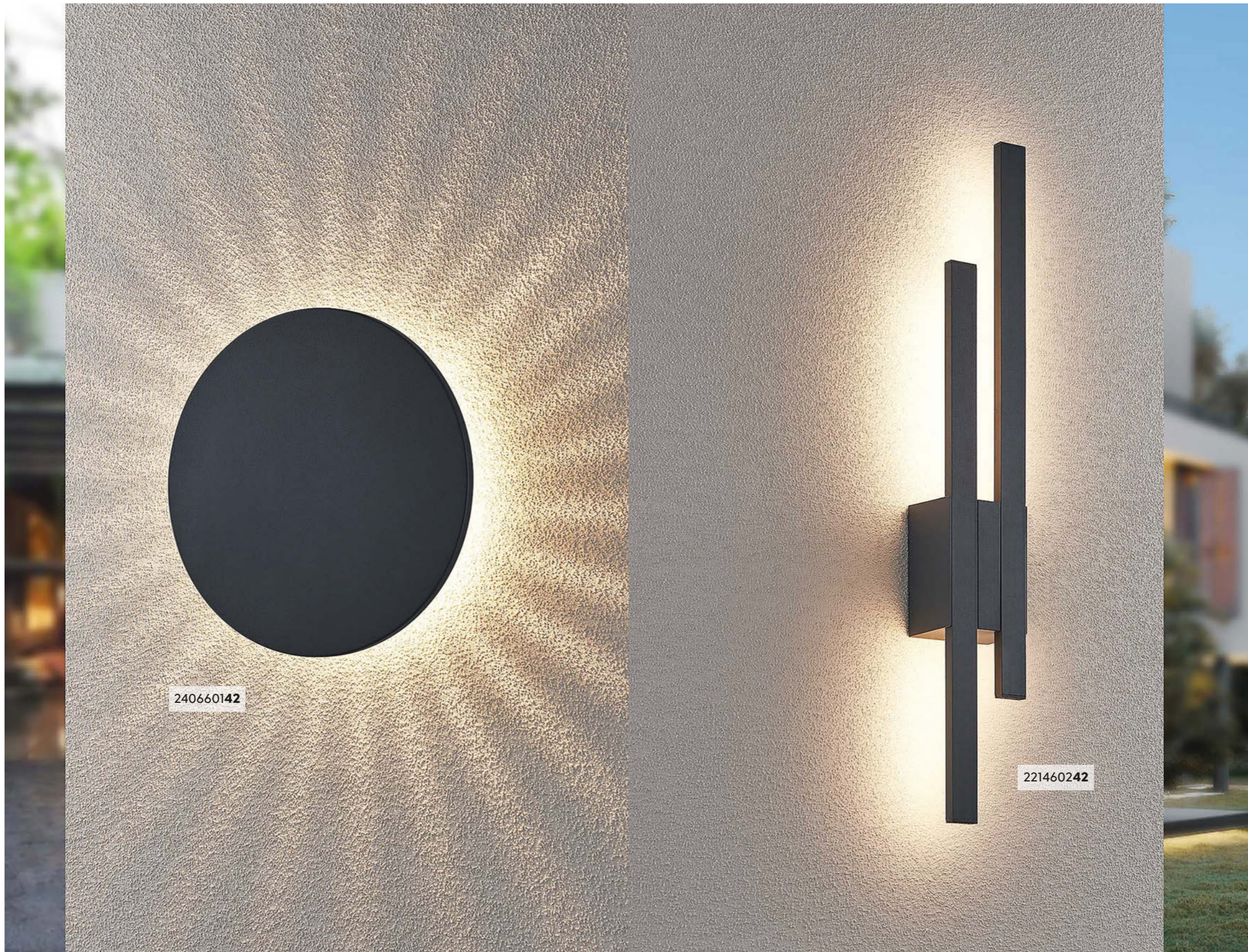
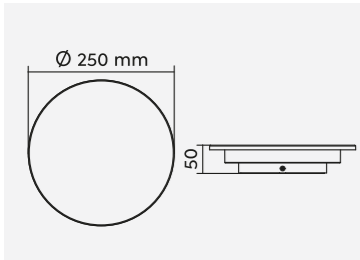

240660142

221460242

# TAWA

Aluminium Druckguss  
 diecast aluminium  
 fonte d'aluminium  
 gegoten aluminium  
 aluminio fundido  
 pressofusione di alluminio  
 fonta aluminiu  
 valualumiini  
 barwione aluminium

**42** Anthrazit · anthracite

Incl. 1 x SMD-LED, 7,5 W  
 800 lm, 3.000 K

**221460142**

Incl. 2 x SMD-LED, 9 W  
 2 x 900 lm, 3.000 K

**221460242**

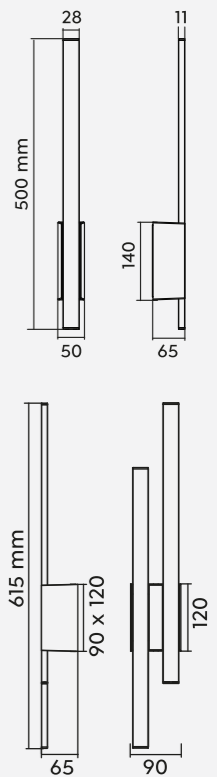

221460142



# COLORADO

Aluminium Druckguss  
 diecast aluminium  
 fonte d'aluminium  
 gegoten aluminium  
 aluminio fundido  
 pressofusione di alluminio  
 fonta aluminiu  
 valualumiini  
 barwione aluminium

**42** Anthrazit · anthracite

Incl. 2 x SMD-LED, 3 W  
 2 x 300 lm, 3.000 K

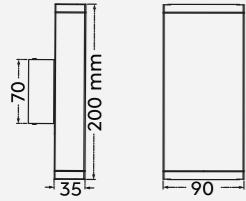

228460242

# THAMES

Aluminium Druckguss  
 diecast aluminium  
 fonte d'aluminium  
 gegoten aluminium  
 aluminio fundido  
 pressofusione di alluminio  
 fonta aluminiu  
 valualumiini  
 barwione aluminium

**42** Anthrazit · anthracite  
**87** titanfarbig · titan

Incl. 2 x SMD-LED, 3 W  
 2 x 340 lm, 3.000 K

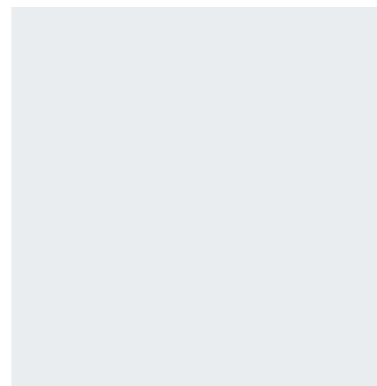
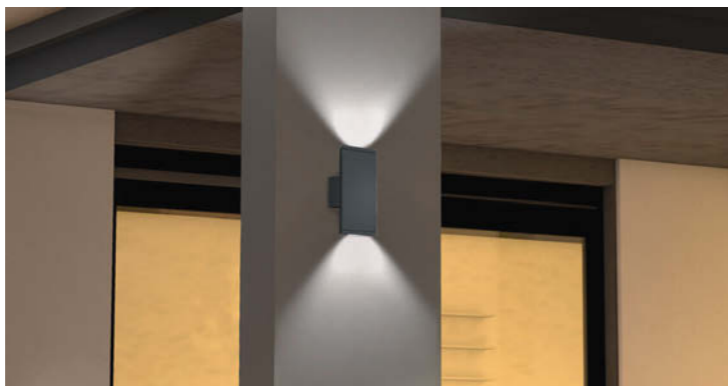
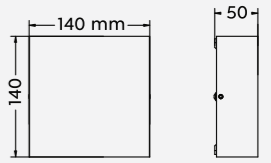

229360287

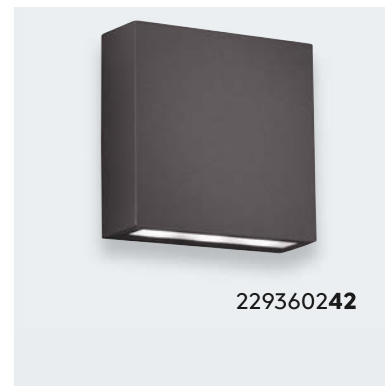

229360242



# THAMES II

Aluminium Druckguss  
diecast aluminium  
fonte d'aluminium  
gegoten aluminium  
aluminio fundido  
pressofusione di alluminio  
fonta aluminiu  
valualumiini  
barwione aluminium

**31** Weiß matt · white mat  
**42** Anthrazit · anthracite

Incl. 2 x SMD-LED, 2,5 W  
2 x 260 lm, 3.000 K  
**227560231**  
**227560242**

Incl. 2 x SMD-LED, 4,5 W  
2 x 400 lm, 3.000 K  
**227660231**  
**227660242**

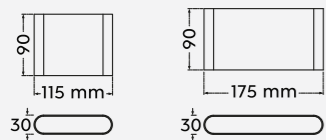

227560231



227560242



227660231



227660242

# THAMES II

Aluminium Druckguss  
diecast aluminium  
fonte d'aluminium  
gegoten aluminium  
aluminio fundido  
pressofusione di alluminio  
fonta aluminiu  
valualumiini  
barwione aluminium

**31** Weiß matt · white mat  
**42** Anthrazit · anthracite

Incl. 2 x SMD-LED, 8 W  
2 x 800 lm, 3.000 K  
**226460231**  
**226460242**

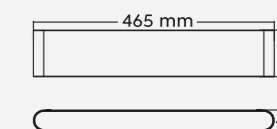

226460231

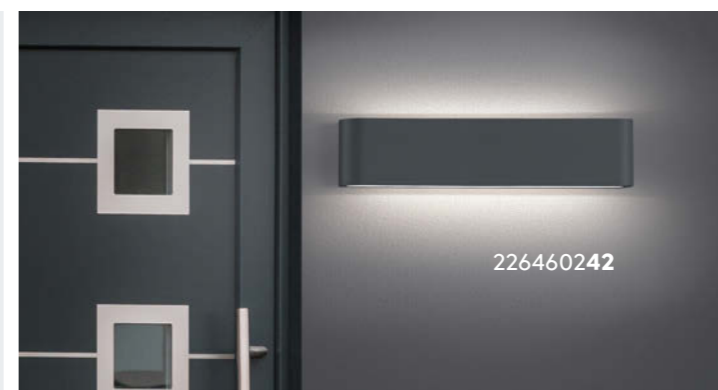
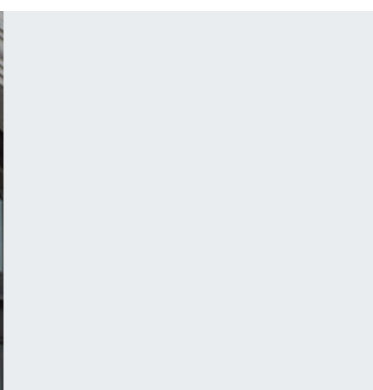
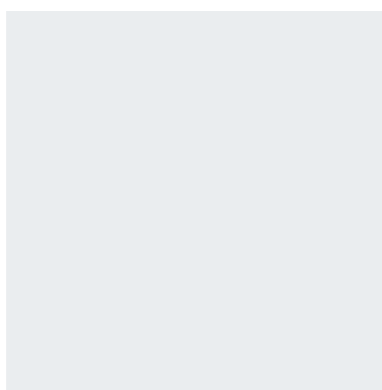

226460242



# TRENT

Aluminium Druckguss  
 diecast aluminium  
 fonte d'aluminium  
 gegoten aluminium  
 aluminio fundido  
 pressofusione di alluminio  
 fonta aluminiu  
 valualumiini  
 barwione aluminium

**31** Weiß matt · white mat  
**42** Anthrazit · anthracite

Incl. SMD-LED, 9 W  
 1.100 lm, 3.000 K

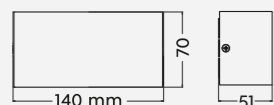

# TAY

Aluminium Druckguss  
 diecast aluminium  
 fonte d'aluminium  
 gegoten aluminium  
 aluminio fundido  
 pressofusione di alluminio  
 fonta aluminiu  
 valualumiini  
 barwione aluminium

**42** Anthrazit · anthracite

Incl. 2 x SMD-LED, 4,5 W  
 2 x 580 lm, 3.000 K

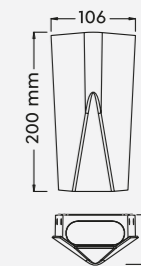

226960231



226960242





# ADAJA

Aluminium Druckguss  
diecast aluminium  
fonte d'aluminium  
gegoten aluminium  
aluminio fundido  
pressofusione di alluminio  
fonta aluminiu  
valualumiini  
barwione aluminium

**31** Weiß matt · white mat  
**42** Anthrazit · anthracite

Incl. 2 x SMD-LED, 3 W  
2 x 350 lm, 3.000 K

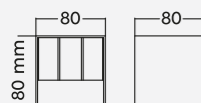

226860242



226860231

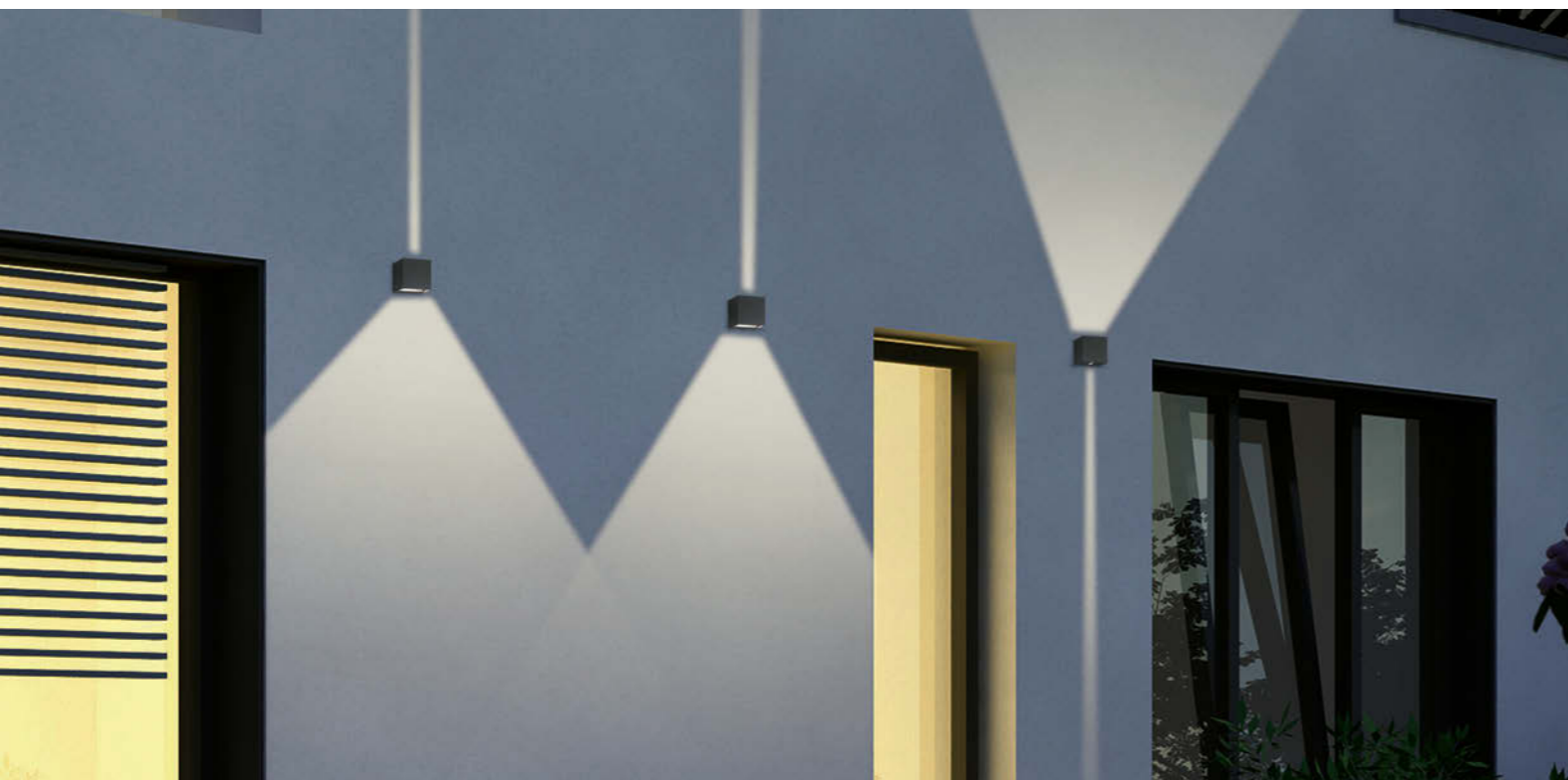

# ARDAS

Aluminium Druckguss, Glas  
diecast aluminium, glass  
fonte d'aluminium, verre  
gegoten aluminium, glas  
aluminio fundido, vidrio  
pressofusione di alluminio, vetro  
fonta aluminiu, sticla  
valualumiini, lasi  
barwione aluminium, szkło

**24** rostfarbig · rusty  
**31** Weiß matt · white mat  
**32** Schwarz matt · black mat

Excl. 2 x GU10, max. 40 W

212560224  
212560231  
212560232

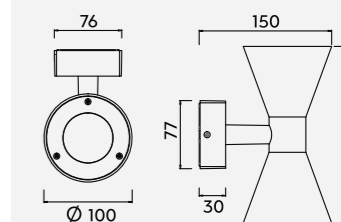

212560232

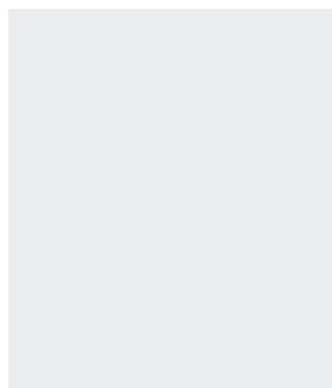
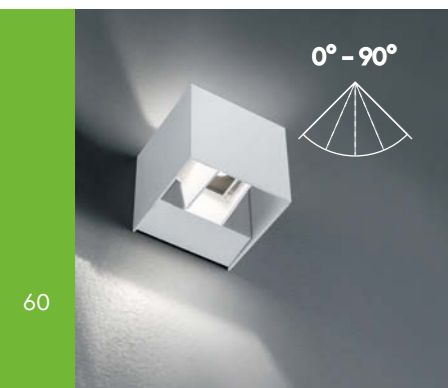

212560224

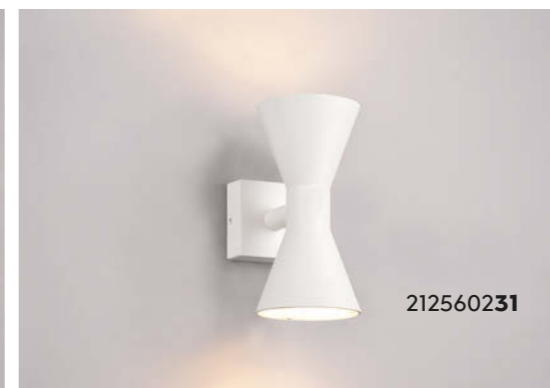

212560231

Empfohlen:  
recommended:

LED GU10, 5 W  
400 lm, 3.000 K  
≥ 110°



955-50



# SACRAMENTO

Aluminium Druckguss  
 diecast aluminium  
 fonte d'aluminium  
 gegoten aluminium  
 aluminio fundido  
 pressofusione di alluminio  
 fonta aluminiu  
 valualumiini  
 barwione aluminium

**42** Anthrazit · anthracite

Incl. 1 x SMD-LED, 2 W  
 200 lm, 3.000 K

Incl. 1 x SMD-LED, 5,5 W  
 650 lm, 3.000 K

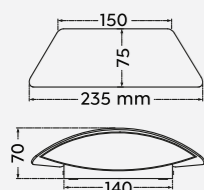

# KONDA

Aluminium Druckguss, Kunststoff  
 diecast aluminium, plastic  
 fonte d'aluminium, plastique  
 gegoten aluminium, kunststof  
 aluminio fundido, plástico  
 pressofusione di alluminio, plastica  
 fonta aluminiu, plastic  
 valualumiini, muovi  
 barwione aluminium, plastik

**42** Anthrazit · anthracite

Incl. 1 x SMD-LED, 9 W  
 1.200 lm, 3.000 K

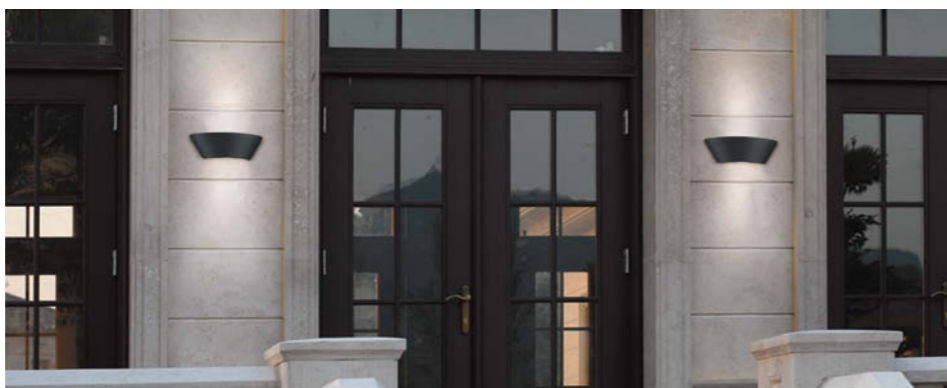
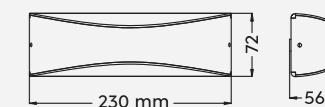



# TRAVE

Aluminium Druckguss, Kunststoff  
 diecast aluminium, plastic  
 fonte d'aluminium, plastique  
 gegoten aluminium, kunststof  
 aluminio fundido, plástico  
 pressofusione di alluminio, plastica  
 fonta aluminiu, plastic  
 valualumiini, muovi  
 barwione aluminium, plastik

**42** Anthrazit · anthracite

Incl. 1 x SMD-LED, 6 W  
 700 lm, 3.000 K

**228760142**

Incl. 1 x SMD-LED, 16 W  
 2.000 lm, 3.000 K

**620160142**

IP54

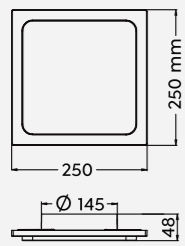
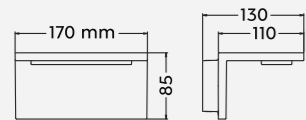

**228760142**



**620160142**

# OHIO

Aluminium Druckguss, Kunststoff  
 diecast aluminium, plastic  
 fonte d'aluminium, plastique  
 gegoten aluminium, kunststof  
 aluminio fundido, plástico  
 pressofusione di alluminio, plastica  
 fonta aluminiu, plastic  
 valualumiini, muovi  
 barwione aluminium, plastik

**42** Anthrazit · anthracite

**87** titanfarbig · titan

Incl. 1 x SMD-LED, 7,5 W  
 800 lm, 3.000 K

IP54

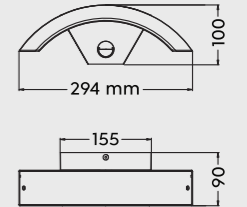

**220969142**

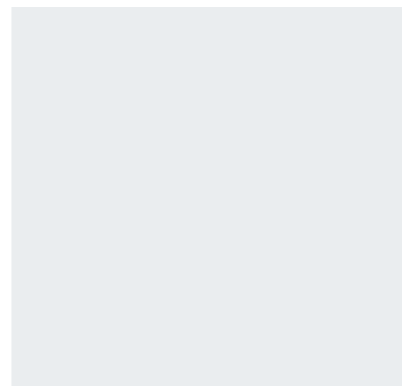
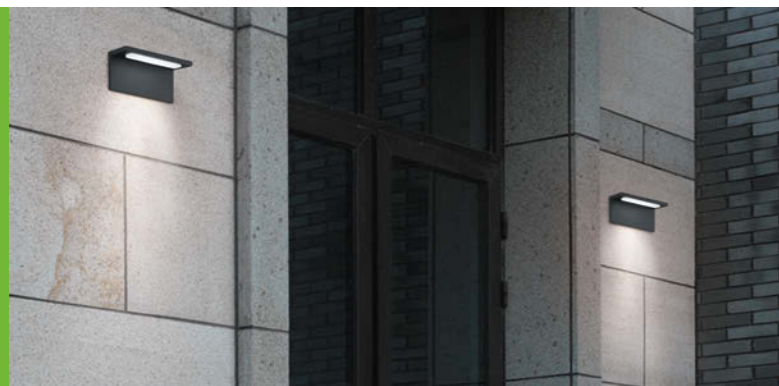

Bewegungssensor  
 Motion sensor  
 Détecteur de mouvement  
 Bewegungssensor  
 Sensor de movimiento  
 Sensore di movimento  
 Senzor de mişcare  
 Liiketunnistin  
 Czujnik ruchu

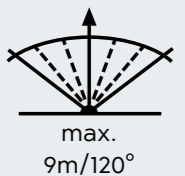



# WITHAM

Aluminium Druckguss  
diecast aluminium  
fonte d'aluminium  
gegoten aluminium  
aluminio fundido  
pressofusione di alluminio  
fonta aluminiu  
valualumiini  
barwione aluminium

**42 Anthrazit · anthracite**

Incl. 1 x SMD-LED, 14 W  
1.550 lm, 2.300 + 3.000 + 4.000 K  
**277860142**

Incl. 1 x SMD-LED, 10,5 W  
1.100 lm, 2.300 + 3.000 + 4.000 K  
**677860142**

Incl. 1 x SMD-LED, 14,5 W  
1.450 lm, 2.300 + 3.000 + 4.000 K  
**477860142**  
**577860142**

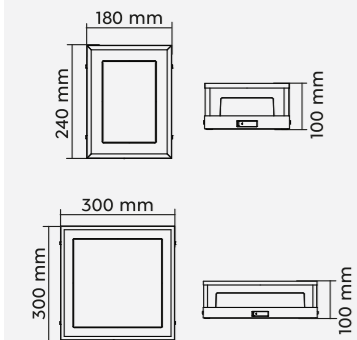

677860142



277860142



477860142



577860142



2.300 K

3.000 K

4.000 K

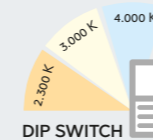

## DIP SWITCH

Lichtfarben direkt an der Leuchte einstellbar

Colours directly adjustable at the lamp

Les couleurs de la lumière peuvent être réglées directement sur le luminaire

Lichtkleuren direct instelbaar op de lamp

Tonalidades de luz ajustables directamente en la lámpara

Colori della luce regolabili direttamente sulla lampada

Culori ale luminii reglabile direct de la bec

Valon väri asetettävissa suoraan valaisimesta

Barwy światła można ustawić bezpośrednio na oprawie



# CUANDO

Aluminium Druckguss, Acryl  
diecast aluminium, acryl  
fonte d'aluminium, acryl  
gegoten aluminium, acryl  
aluminio fundido, acrílico  
pressofusione di alluminio, acrilico  
fonta aluminiu, acrilic  
valualumiini, akryyli  
barwione aluminium, akryl

**42** Anthrazit · anthracite

Incl. SMD-LED, 11 W  
1.400 lm, 3.000 K

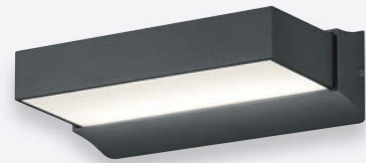
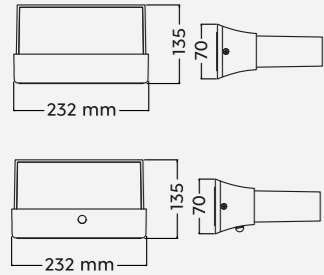

226660242



226669242



# INDUS

Aluminium Druckguss, Kunststoff  
diecast aluminium, plastic  
fonte d'aluminium, plastique  
gegoten aluminium, kunststof  
aluminio fundido, plástico  
pressofusione di alluminio, plastica  
fonta aluminiu, plastic  
valualumiini, muovi  
barwione aluminium, plastik

**42** Anthrazit · anthracite

Incl. 2 x SMD-LED, 4 W  
2 x 500 lm, 3.000 K

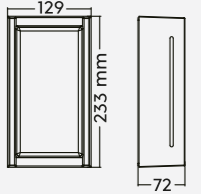

227360142

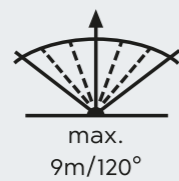

Bewegungssensor  
Motion sensor  
Détecteur de mouvement  
Bewegingssensor  
Sensor de movimiento  
Sensore di movimento  
Senzor de mişcare  
Liiketunnistin  
Czujnik ruchu





# YANGTZE

Aluminium Druckguss, Kunststoff  
 diecast aluminium, plastic  
 fonte d'aluminium, plastique  
 gegoten aluminium, kunststof  
 aluminio fundido, plástico  
 pressofusione di alluminio, plastica  
 fonta aluminiu, plastic  
 valualumiini, muovi  
 barwione aluminium, plastik

**01** Weiß · white  
**42** Anthrazit · anthracite

Incl. 1 x SMD-LED, 4,5 W  
 400 lm, 3.000 K

IP54

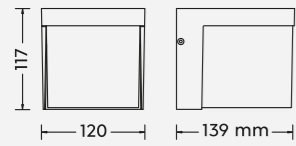

228260101



228260142

# MITCHELL

Aluminium Druckguss, Acryl  
 diecast aluminium, acryl  
 fonte d'aluminium, acryl  
 gegoten aluminium, acryl  
 aluminio fundido, acrílico  
 pressofusione di alluminio, acrilico  
 fonta aluminiu, acrilic  
 valualumiini, akryyli  
 barwione aluminium, akryl

**42** Anthrazit · anthracite

Incl. 1 x SMD-LED, 7,5 W  
 750 lm, 3.000 K  
**273360142**

IP54

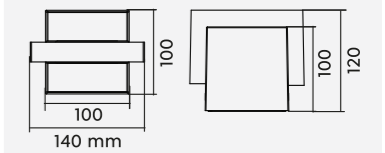

273360142

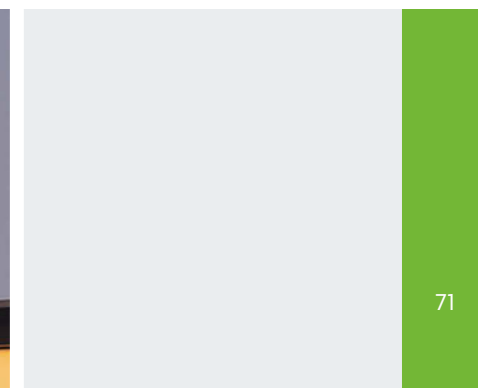
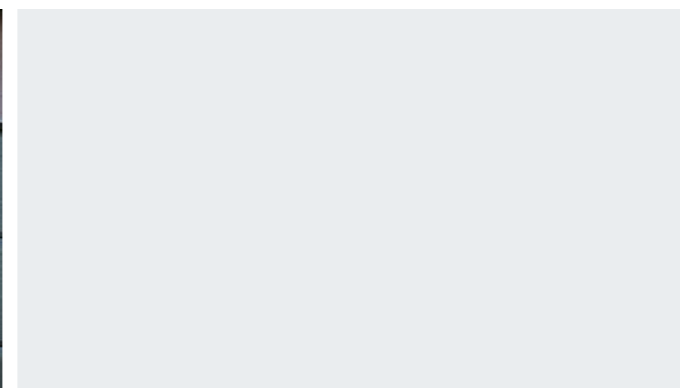
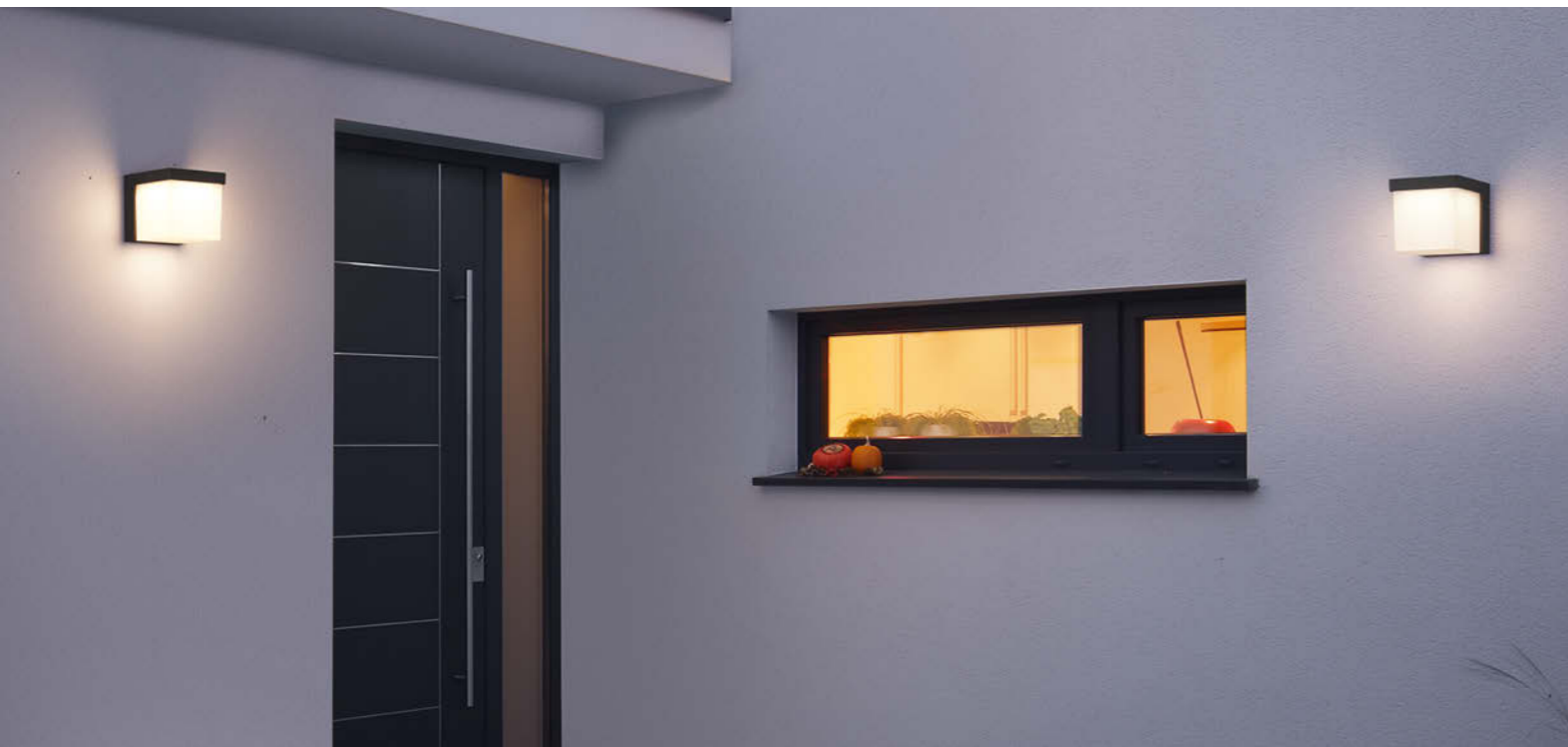



# TIBER

Aluminium Druckguss  
 diecast aluminium  
 fonte d'aluminium  
 gegoten aluminium  
 aluminio fundido  
 pressofusione di alluminio  
 fonta aluminiu  
 valualumiini  
 barwione aluminium

**42** Anthrazit · anthracite

Incl. 1 x COB-LED, 3 W  
 300 lm, 3.000 K

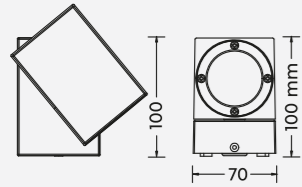

229160142

# CLYDE

Aluminium Druckguss  
 diecast aluminium  
 fonte d'aluminium  
 gegoten aluminium  
 aluminio fundido  
 pressofusione di alluminio  
 fonta aluminiu  
 valualumiini  
 barwione aluminium

**42** Anthrazit · anthracite

Incl. 2 x SMD-LED, 3 W  
 2 x 300 lm, 3.000 K

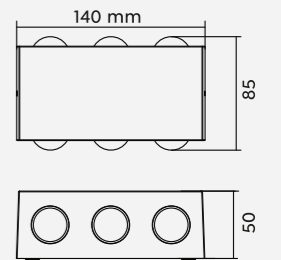

240760142

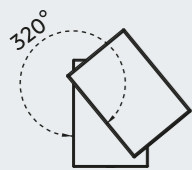



# TUNGA

Aluminium Druckguss  
diecast aluminium  
fonte d'aluminium  
gegoten aluminium  
aluminio fundido  
pressofusione di alluminio  
fonta aluminiu  
valualumiini  
barwione aluminium

**31** Weiß matt · white mat  
**42** Anthrazit · anthracite

Incl. 1 x SMD-LED, 3,5 W  
420 lm, 3.000 K  
**222969131**  
**222969142**



Incl. 2 x SMD-LED, 3,5 W  
2 x 420 lm, 3.000 K  
**222969231**  
**222969242**



222969131



222969142



222969231

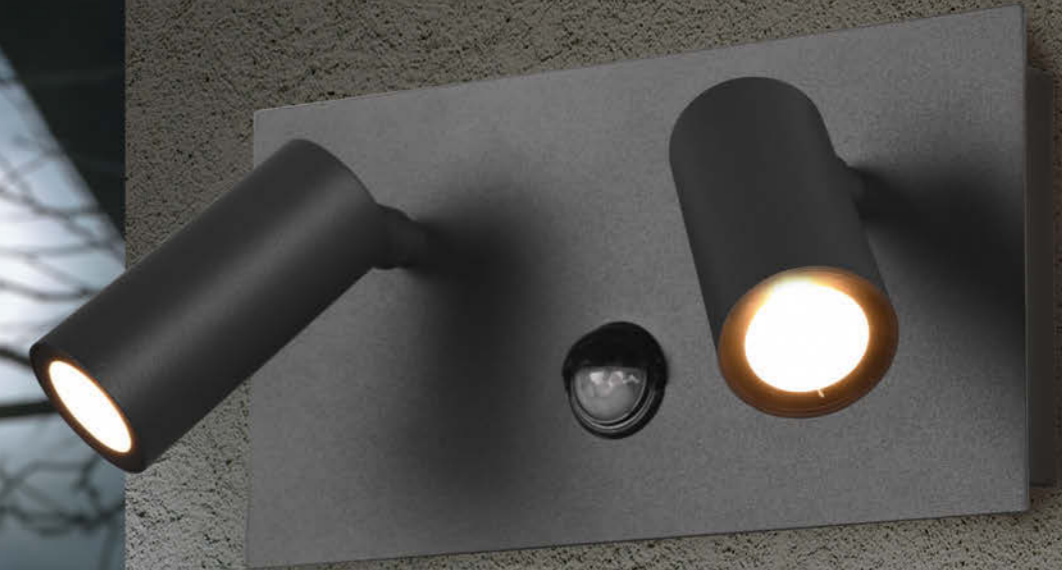
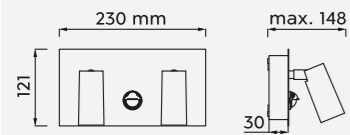
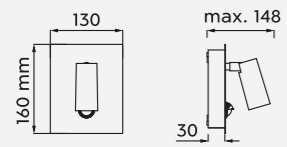

222969242

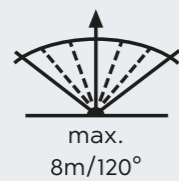

Bewegungssensor  
Motion sensor  
Détecteur de mouvement  
Bewegingssensor  
Sensor de movimiento  
Sensore di movimento  
Senzor de mişcare  
Liiketunnistin  
Czujnik ruchu



# TUNGA

Aluminium Druckguss  
 diecast aluminium  
 fonte d'aluminium  
 gegoten aluminium  
 aluminio fundido  
 pressofusione di alluminio  
 fonta aluminii  
 valualumiini  
 barwione aluminium

**31** Weiß matt · white mat  
**42** Anthrazit · anthracite

Incl. 1 x SMD-LED, 3,5 W  
 420 lm, 3.000 K  
**222960131**  
**222960142**

IP54

Incl. 2 x SMD-LED, 3,5 W  
 2 x 420 lm, 3.000 K  
**222960231**  
**222960242**

IP54

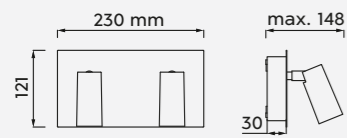
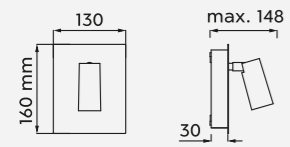

222960131



222960142

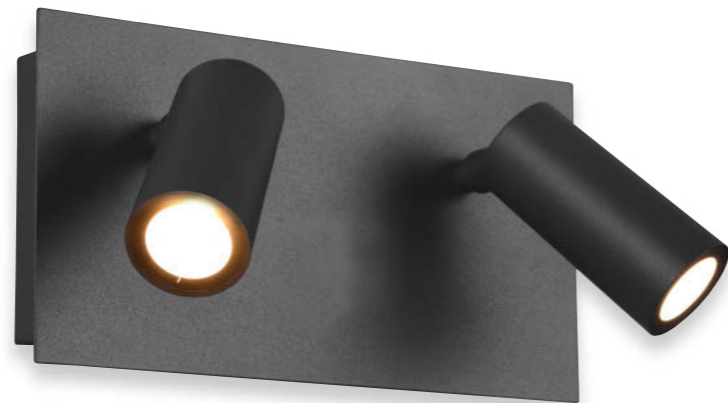

222960242



222960231





# MUGA

Aluminium Druckguss, Kunststoff  
diecast aluminium, plastic  
fonte d'aluminium, plastique  
gegoten aluminium, kunststof  
aluminio fundido, plástico  
pressofusione di alluminio, plastica  
fonta aluminiu, plastic  
valualumiini, muovi  
barwione aluminium, plastik

42 Anthrazit · anthracite

Incl. 1 x SMD-LED, 5 W  
550 lm, 3.000 K

IP54

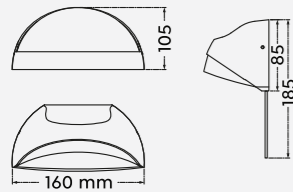

228360142

# MERSEY

Aluminium Druckguss, Kunststoff  
diecast aluminium, plastic  
fonte d'aluminium, plastique  
gegoten aluminium, kunststof  
aluminio fundido, plástico  
pressofusione di alluminio, plastica  
fonta aluminiu, plastic  
valualumiini, muovi  
barwione aluminium, plastik

42 Anthrazit · anthracite

Excl. 2 x E14, max. 40 W

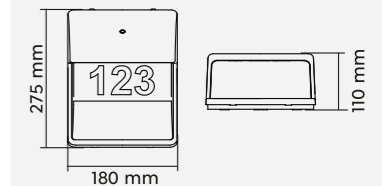

212160242



Dämmerungssensor  
Dusk sensor  
Décteur de crépuscule  
Schemeringsensor  
Sensor de oscuridad  
Sensore crepuscolare  
Senzor de lumina/amurg  
Hämärätunnistin  
Czujnik zmierzchowy

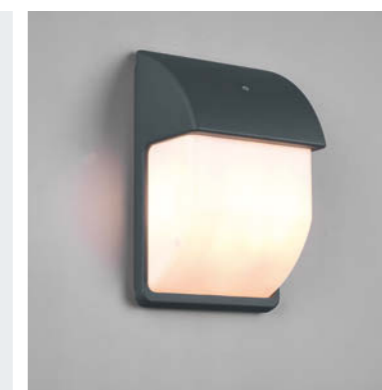

Empfohlen:  
recommended:

LED E14, 3,5 W  
320 lm, 3.000 K



983-40

79

78



# PECOS

Aluminium Druckguss, Kunststoff  
 diecast aluminium, plastic  
 fonte d'aluminium, plastique  
 gegoten aluminium, kunststof  
 aluminio fundido, plástico  
 pressofusione di alluminio, plastica  
 fonta aluminiu, plastic  
 valualumiini, muovi  
 barwione aluminium, plastik

**42** Anthrazit · anthracite

Incl. 1 x SMD-LED, 6 W  
 600 lm, 3.000 K

IP54

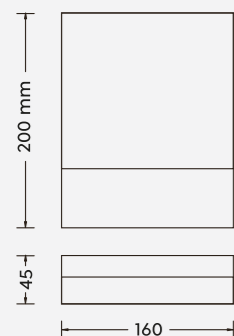

227760142



# KASAI

Aluminium Druckguss, Kunststoff  
 diecast aluminium, plastic  
 fonte d'aluminium, plastique  
 gegoten aluminium, kunststof  
 aluminio fundido, plástico  
 pressofusione di alluminio, plastica  
 fonta aluminiu, plastic  
 valualumiini, muovi  
 barwione aluminium, plastik

**42** Anthrazit · anthracite

Incl. 1 x SMD-LED, 9 W  
 850 lm, 3.000 K

IP54

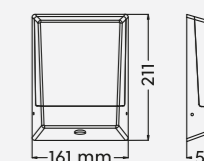

228669142



Dämmerungssensor  
 Dusk sensor  
 Détecteur de crépuscule  
 Schemeringsensor  
 Sensor de oscuridad  
 Sensore crepuscolare  
 Senzor de lumina/amurg  
 Hämärätunnistin  
 Czujnik zmierzchowy  
 Alacakaranlık Algılayıcısı





# TIMOK

Aluminium Druckguss, Kunststoff  
 diecast aluminium, plastic  
 fonte d'aluminium, plastique  
 gegoten aluminium, kunststof  
 aluminio fundido, plástico  
 pressofusione di alluminio, plastica  
 fonta aluminiu, plastic  
 valualumiini, muovii  
 barwione aluminium, plastik

- 01** Weiß · white
- 42** Anthrazit · anthracite

Incl. 1 x LED E27, 4,9 W  
 470 lm, 3.000 K

IP54

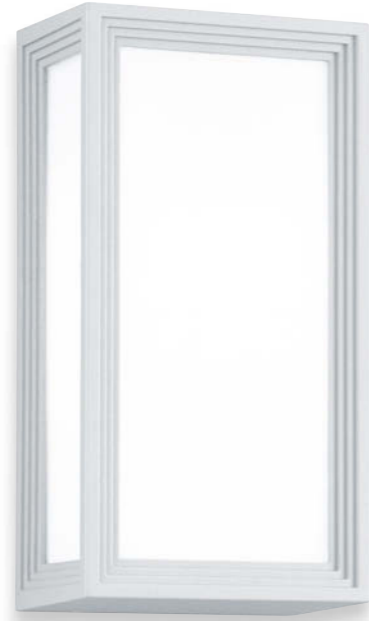
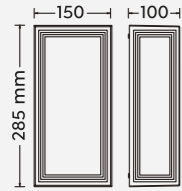

228060101



228060142

# HONDO

Aluminium Druckguss, Kunststoff  
 diecast aluminium, plastic  
 fonte d'aluminium, plastique  
 gegoten aluminium, kunststof  
 aluminio fundido, plástico  
 pressofusione di alluminio, plastica  
 fonta aluminiu, plastic  
 valualumiini, muovii  
 barwione aluminium, plastik

- 42** Anthrazit · anthracite

Incl. 1 x SMD-LED, 3,5 W  
 330 lm, 3.000 K

IP54

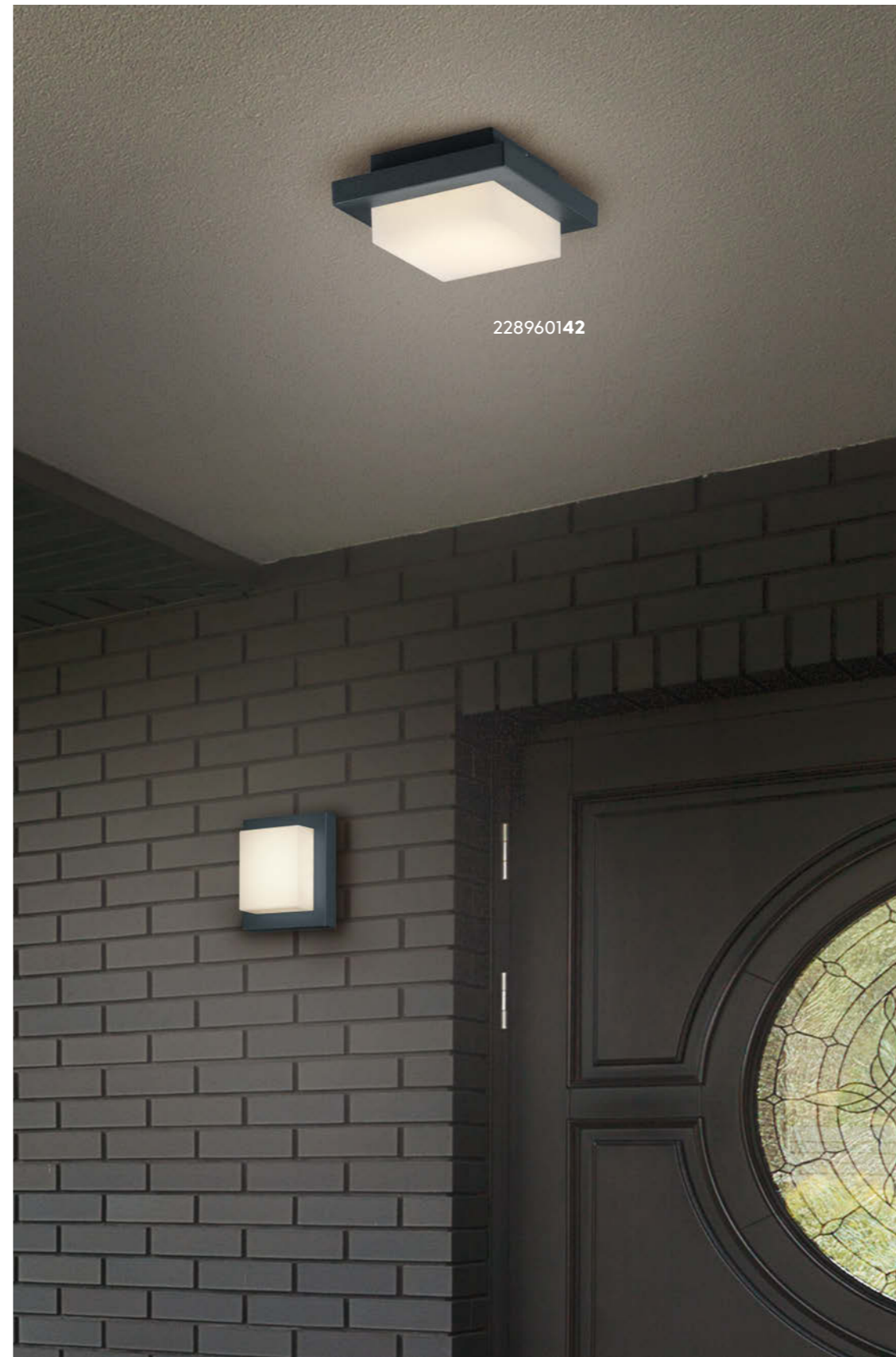
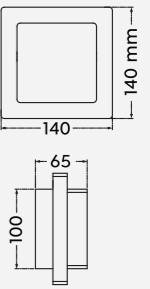

228960142

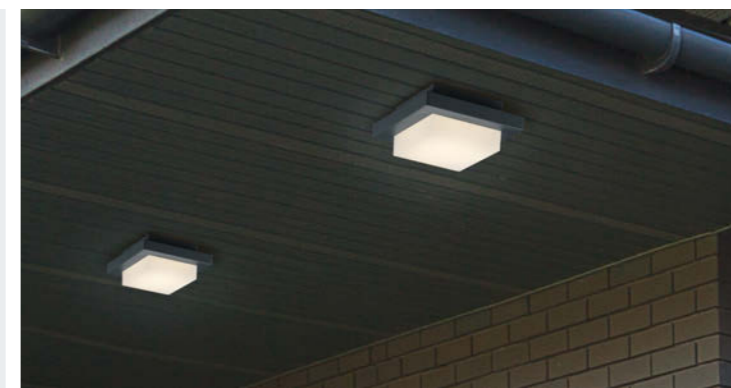
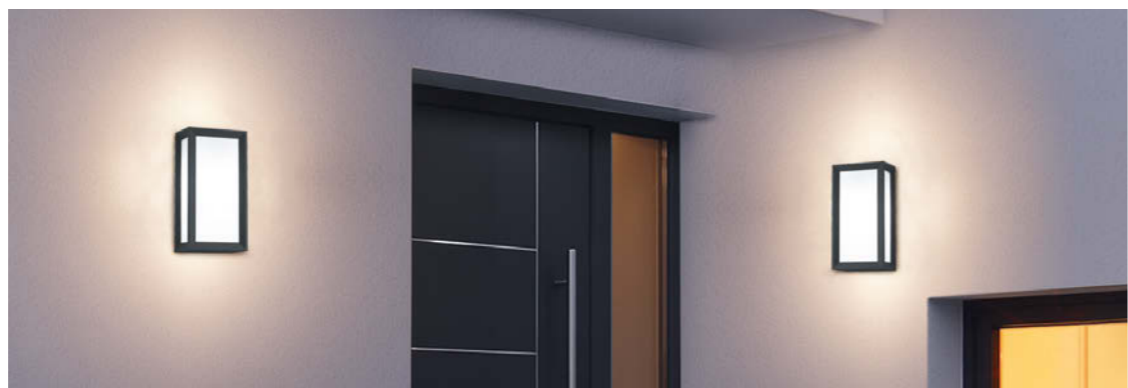



# BREG

Aluminium Druckguss, Kunststoff  
 diecast aluminium, plastic  
 fonte d'aluminium, plastique  
 gegoten aluminium, kunststof  
 aluminio fundido, plástico  
 pressofusione di alluminio, plastica  
 fonta aluminiu, plastic  
 valualumiini, muovi  
 barwione aluminium, plastik

**42** Anthrazit · anthracite

Incl. 1 x SMD-LED, 8,5 W  
 850 lm, 3.000 K

**IP54**

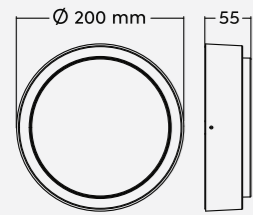

227260142



# PEDRO

Aluminium Druckguss, Acryl  
 diecast aluminium, acryl  
 fonte d'aluminium, acryl  
 gegoten aluminium, acryl  
 aluminio fundido, acrílico  
 pressofusione di alluminio, acrilico  
 fonta aluminiu, acrilic  
 valualumiini, akryyli  
 barwione aluminium, akryl

**42** Anthrazit · anthracite

Incl. 1 x SMD-LED, 9 W  
 1.000 lm, 3.000 K

**IP54**

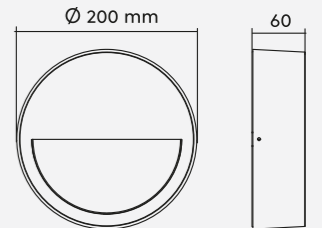

222860142

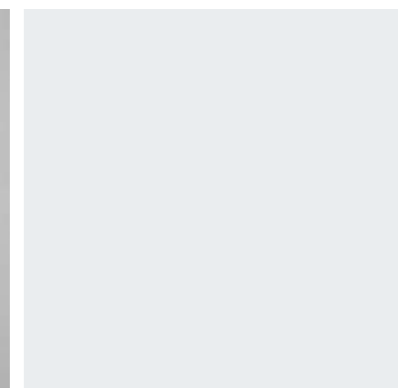
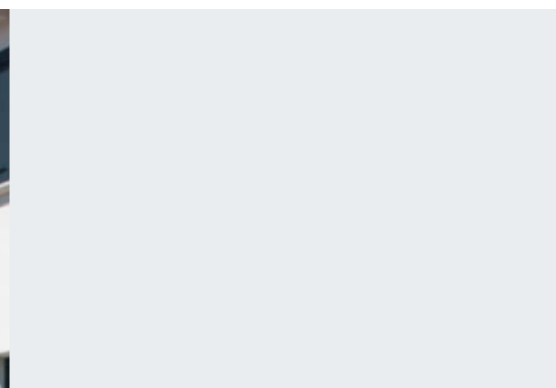
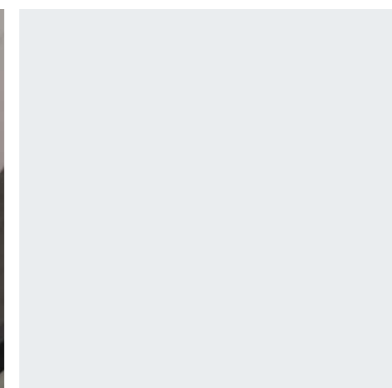



# PIAVE

Kunststoff  
plastic  
plastique  
kunststof  
plástico  
plastica  
plastic  
muovi  
plastik

**31** Weiß matt · white mat  
**42** Anthrazit · anthracite

Incl. SMD-LED, 11 W  
1.180 lm, 3.000 K

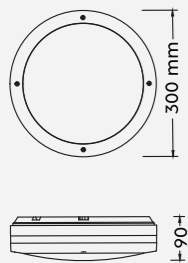

676960131



676960142

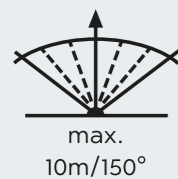

max.  
10m/150°



Bewegungssensor  
Motion sensor  
Détecteur de mouvement  
Bewegingssensor  
Sensor de movimiento  
Sensore di movimento  
Senzor de mişcare  
Liiketunnistin  
Czujnik ruchu





# ARDILA

Aluminium Druckguss, Glas  
diecast aluminium, glass  
fonte d'aluminium, verre  
gegoten aluminium, glas  
aluminio fundido, vidrio  
pressofusione di alluminio, vetro  
fonta aluminiu, sticla  
valualumiini, lasi  
barwione aluminium, szkło

**32** Schwarz matt · black mat

Excl. 1 x E27, max. 40 W

211660132

411660132

511660132

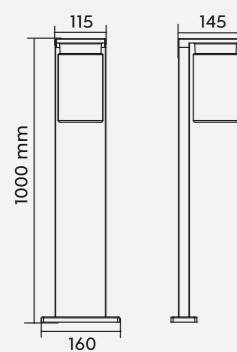
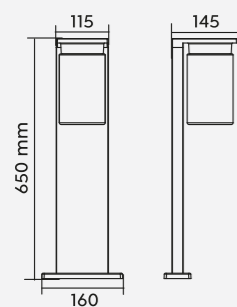
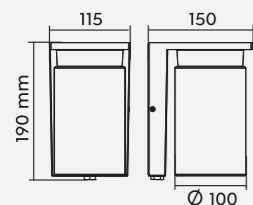

211660132



511660132



411660132

Empfohlen:  
recommended:

Filament LED  
E27, 4 W  
470 lm, 2.700 K



987-400

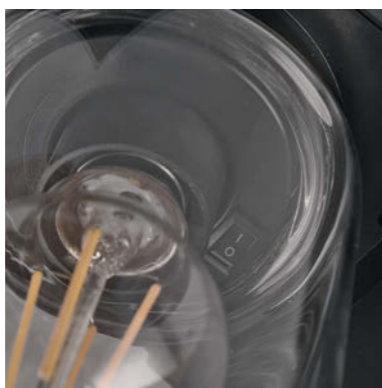

Dämmerungssensor per Schalter deaktivierbar  
On and off switchable dusk sensor  
Détecteur de crépuscule commutable  
Aan en uit schakelbare schemeringsensor  
Sensor de oscuridad conmutable on/off  
Sensore crepuscolare commutabile on/off  
senzor de lumina/amurg on/off  
On/off kytkettävä hämärätunnistin  
Czujnik zmierzchowy dezaktywowany przez przełącznika





# HOOSIC

Aluminium Druckguss, Kunststoff  
 diecast aluminium, plastic  
 fonte d'aluminium, plastique  
 gegoten aluminium, kunststof  
 aluminio fundido, plástico  
 pressofusione di alluminio, plastica  
 fonta aluminiu, plastic  
 valualumiini, muovi  
 barwione aluminium, plastik

**24** rostfarbig · rusty

Excl. 1 x E27, max. 28 W

**222260124**

**422260124**

**522260124**

Excl. 2 x E27, max. 28 W

**222260224**



222260124

222260224



422260124



522260124

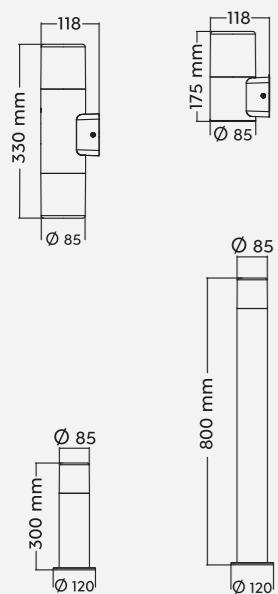

Empfohlen:  
 recommended:

LED E27, 4,9 W  
 470 lm, 3.000 K



**987-60**

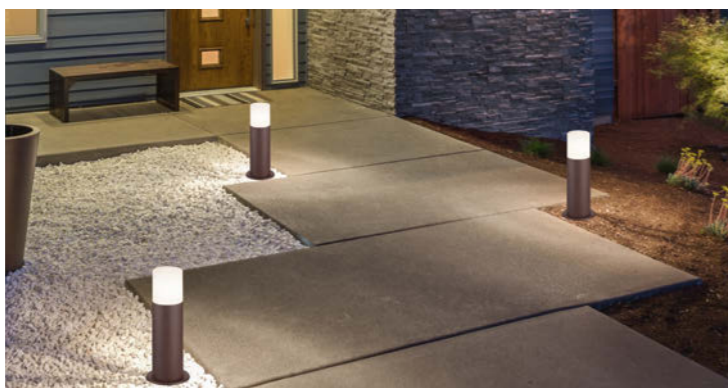



# HOOSIC

Aluminium Druckguss, Kunststoff  
 diecast aluminium, plastic  
 fonte d'aluminium, plastique  
 gegoten aluminium, kunststof  
 aluminio fundido, plástico  
 pressofusione di alluminio, plastica  
 fonta aluminiu, plastic  
 valualumiini, muovi  
 barwione aluminium, plastik

**42 Anthrazit · anthracite**

Excl. 1 x E27, max. 28 W

**222260142**

**422260142**

**522260142**

Excl. 2 x E27, max. 28 W

**222260242**

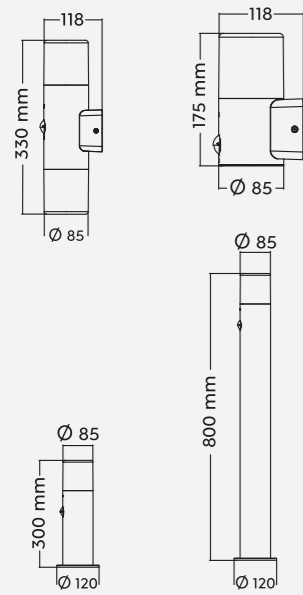

222260142



222260242



522260142



422260142



Empfohlen:  
 recommended:

LED E27, 4,9 W  
 470 lm, 3.000 K



**987-60**

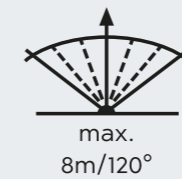

Bewegungssensor  
 Motion sensor  
 Détecteur de mouvement  
 Bewegungssensor  
 Sensor de movimiento  
 Sensore di movimento  
 Senzor de mişcare  
 Liiketunnistin  
 Czujnik ruchu





# HOOSIC

Aluminium Druckguss, Kunststoff  
diecast aluminium, plastic  
fonte d'aluminium, plastique  
gegoten aluminium, kunststof  
aluminio fundido, plástico  
pressofusione di alluminio, plastica  
fonta aluminiu, plastic  
valualumiini, muovi  
barwione aluminium, plastik

**42 Anthrazit · anthracite**

Excl. 1 x E27, max. 28 W

**224060142**

**424060142**

**524060142**

Excl. 2 x E27, max. 28 W

**224060242**

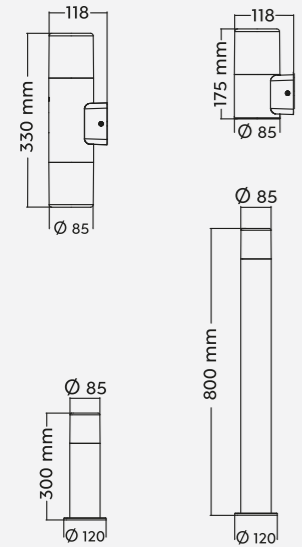

224060242



224060142



524060142



424060142



424067142

# HOOSIC

Aluminium Druckguss, Kunststoff  
diecast aluminium, plastic  
fonte d'aluminium, plastique  
gegoten aluminium, kunststof  
aluminio fundido, plástico  
pressofusione di alluminio, plastica  
fonta aluminiu, plastic  
valualumiini, muovi  
barwione aluminium, plastik

**42 Anthrazit · anthracite**

Excl. 1 x E27, max. 28 W

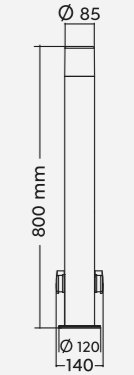

Empfohlen:  
recommended:

LED E27, 4,9 W  
470 lm, 3.000 K



**987-60**

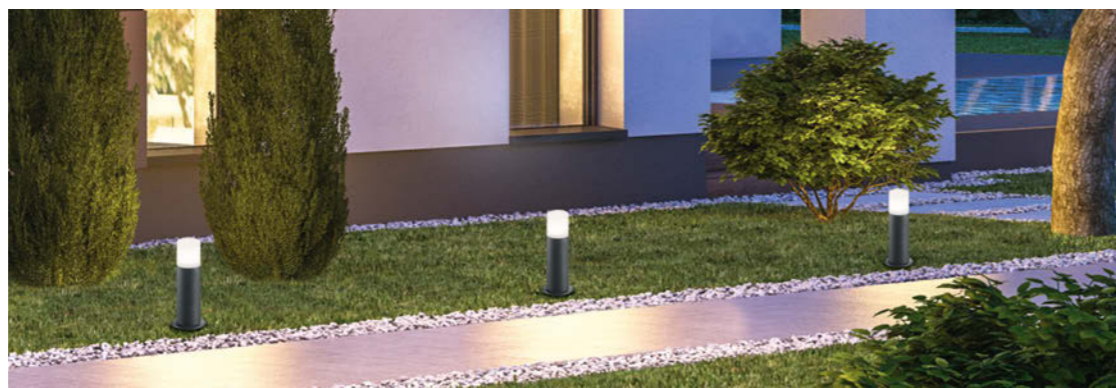



# HUDSON

Aluminium Druckguss, Kunststoff  
 diecast aluminium, plastic  
 fonte d'aluminium, plastique  
 gegoten aluminium, kunststof  
 aluminio fundido, plástico  
 pressofusione di alluminio, plastica  
 fonta aluminiu, plastic  
 valualumiini, muovi  
 barwione aluminium, plastik

**42 Anthrazit · anthracite**

Incl. 1 x LED E14, 4 W  
 320 lm, 3.000 K

**220060142**  
**420060142**  
**520060142**

Incl. 2 x LED E14, 4 W  
 2 x 320 lm, 3.000 K

**220060242**

IP44

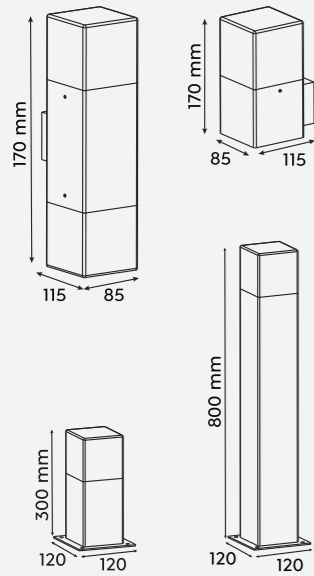

220060142



220060242



520060142



420060142



Incl. LED E14, 3,5 W  
 320 lm, 3.000 K



**983-40**

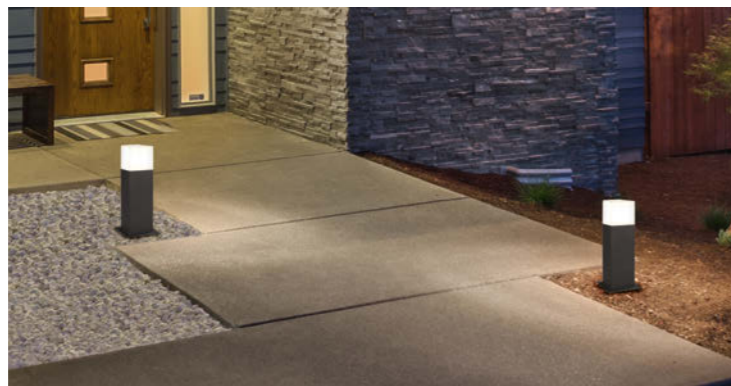



# CUBANGO

Aluminium Druckguss, Kunststoff  
diecast aluminium, plastic  
fonte d'aluminium, plastique  
gegoten aluminium, kunststof  
aluminio fundido, plástico  
pressofusione di alluminio, plastica  
fonta aluminu, plastic  
valualumiini, muovi  
barwione aluminium, plastik

42 Anthrazit · anthracite

Incl. 1 x LED E27, 5 W  
400 lm, 3.000 K

IP54

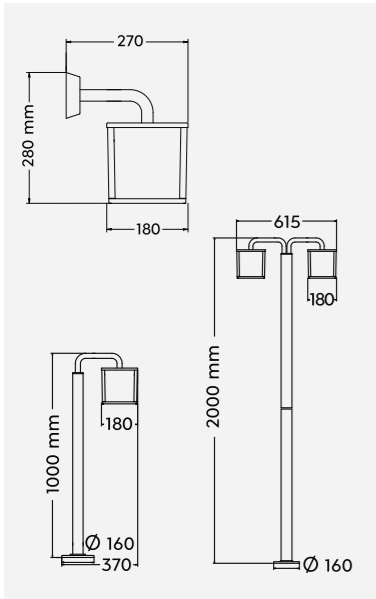

221560142



421560142



421560242

Incl. LED E27, 4,9 W  
470 lm, 3.000 K



986-60





# NORMAN

Aluminium Druckguss, Acryl  
diecast aluminium, acryl  
fonte d'aluminium, acryl  
gegoten aluminium, acryl  
aluminio fundido, acrílico  
pressa fusione di alluminio, acrilico  
fonta aluminu, acrilic  
valualumiini, akryyli  
barwione aluminium, akryl

**24** rostfarbig · rusty  
**31** Weiß matt · white mat  
**42** Anthrazit · anthracite

Excl. 1 x E27, max. 40 W

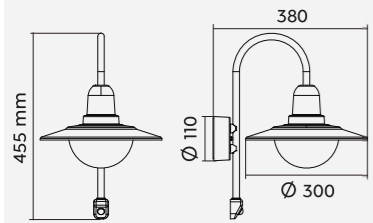

207269131



207269142



207269124

Empfohlen:  
recommended:

LED E27, 4,9 W  
470 lm, 3.000 K



987-60

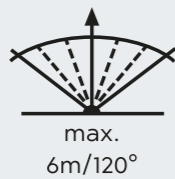

Bewegungssensor  
Motion sensor  
Décteur de mouvement  
Bewegingssensor  
Sensor de movimiento  
Sensore di movimento  
Senzor de mişcare  
Liiketunnistin  
Czujnik ruchu



# COOPER

Edelstahl, Kunststoff  
steel, plastic  
acier, plastique  
staal, kunststof  
acero, plástico  
acciaio, plastica  
inox, plastic  
teräs, muovi  
stal, plastik

**42** Anthrazit · anthracite

Excl. 1 x E27, max. 40 W

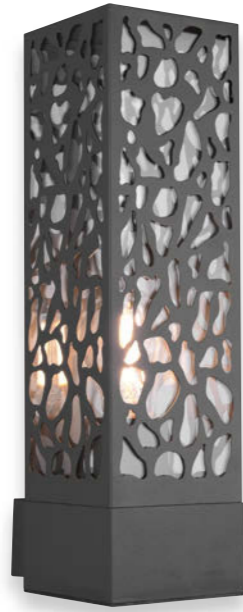

207360142

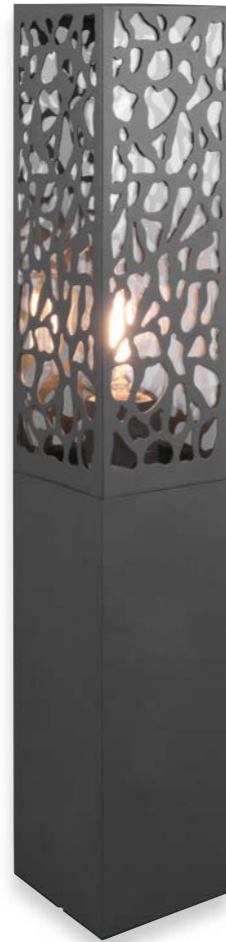

507360142



407360142

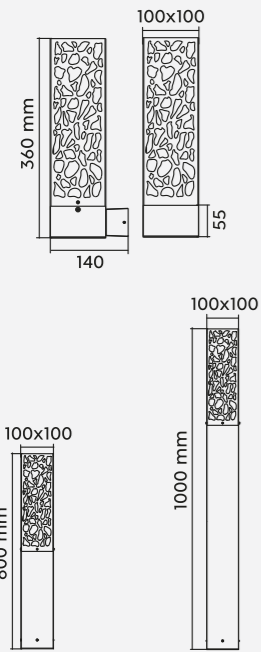

Empfohlen:  
recommended:

Filament LED  
E27, 4 W  
470 lm, 2.700 K



**987-400**





# CANNING

Aluminium Druckguss, Naturholz  
 diecast aluminium, natural wood  
 fonte d'aluminium, bois naturel  
 gegoten aluminium, natuur hout  
 aluminio fundido, madera natural  
 pressofusione di alluminio, legno naturale  
 fonta aluminiu, lemn natural  
 valualumiini, luonnonpuu  
 barwione aluminium, drewno naturalne

30 holzfarbig / Anthrazit ·  
 wood coloured / anthracite

Excl. 1 x GU10, max. 28 W

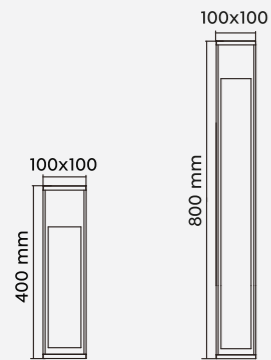
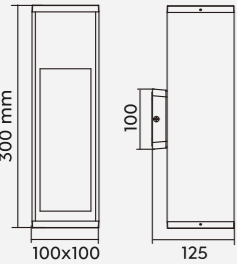

209660130



509660130



409660130



Empfohlen:  
 recommended:

LED GU10, 5 W  
 400 lm, 3.000 K  
 > 110°



955-50





# GARONNE

Aluminium Druckguss,  
Naturholz, Glas  
diecast aluminium,  
natural wood, glass  
fonte d'aluminium,  
bois naturel, verre  
gegoten aluminium,  
natuur hout, glas  
aluminio fundido,  
madera natural, vidrio  
pressofusione di alluminio,  
legno naturale, vetro  
fonta aluminiu,  
lemn natural, sticla  
valualumiini,  
luonnonpuu, lasi  
barwione aluminium,  
drewno naturalne, szkło

30 holzfarbig / Anthrazit ·  
wood coloured / anthracite

Excl. 1 x E27, max. 40 W



IP44

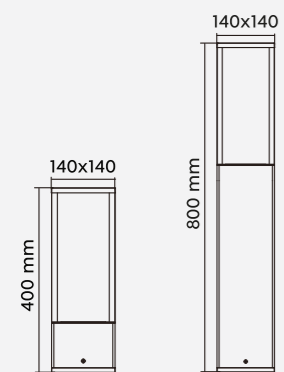
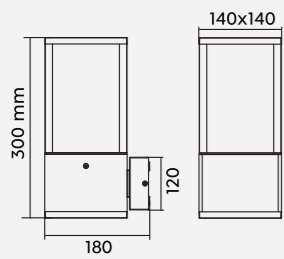

201860130



501860130



401860130



Empfohlen:  
recommended:

Filament LED  
E27, 4 W  
470 lm, 2.700 K



987-400



# GARONNE

Aluminium Druckguss, Glas  
 diecast aluminium, glass  
 fonte d'aluminium, verre  
 gegoten aluminium, glas  
 aluminio fundido, vidrio  
 pressofusione di alluminio, vetro  
 fonta aluminiu, sticla  
 valualumiini, lasi  
 barwione aluminium, szkło

**42** Anthrazit · anthracite

Excl. 1 x E27, max. 40 W

201860142

401860142

501860142

Excl. 2 x E27, max. 40 W

201860242

601860242

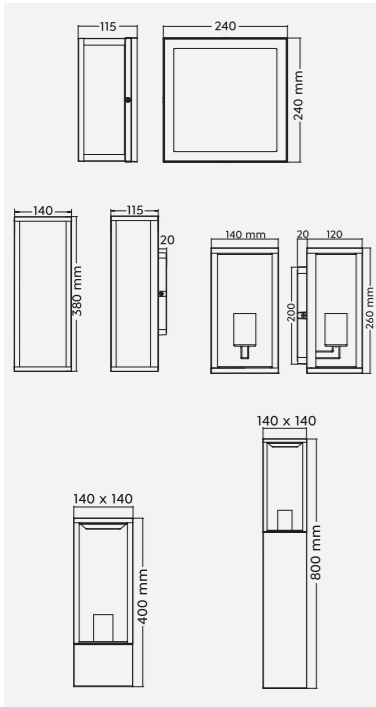

601860242



201860142



201860242



501860142



401860142



Empfohlen:  
 recommended:

Filament LED  
 E27, 7 W  
 806 lm, 3.000 K



987-600

Empfohlen:  
 recommended:

Filament LED  
 E27, 4 W  
 470 lm, 2.700 K



987-400





# LUNGA

Aluminium Druckguss, Glas  
diecast aluminium, glass  
fonte d'aluminium, verre  
gegoten aluminium, glas  
aluminio fundido, vidrio  
pressofusione di alluminio, vetro  
fonta aluminiu, sticla  
valualumiini, lasi  
barwione aluminium, szkło

42 Anthrazit · anthracite

Excl. 1 x E27, max. 40 W

212069142



Excl. 1 x E27, max. 40 W

212060142

412060142

512060142

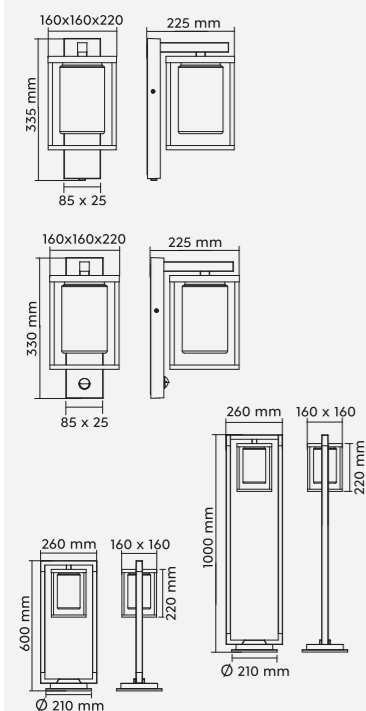

212060142



512060142

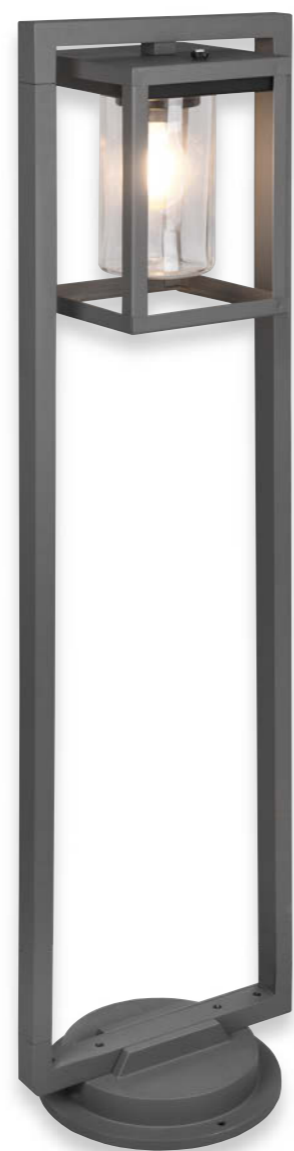

412060142



212069142

Empfohlen:  
recommended:

Filament LED  
E27, 4 W  
470 lm, 2.700 K



987-400



Dämmerungssensor per Schalter deaktivierbar

On and off switchable dusk sensor

Détecteur de crépuscule commutable

Aan en uit schakelbare schemeringsensor

Sensor de oscuridad conmutable on/off

Sensore crepuscolare commutabile on/off

senzor de lumina/amurg on/off

On/off kytkettävä hämärätunnistin

Czujnik zmierzchowy dezaktywowany przez przełącznika

Aç-kapa anahtarlı karanlık sensörü



Bewegungssensor

Motion sensor

Détecteur de mouvement

Bewegungssensor

Sensor de movimiento

Sensore di movimento

Senzor de mișcare

Liiketunnistin

Czujnik ruchu



max.  
8m/120°





# SAMBESI

Aluminium Druckguss, Acryl  
diecast aluminium, acryl  
fonte d'aluminium, acryl  
gegoten aluminium, acryl  
aluminio fundido, acrílico  
pressofusione di alluminio, acrilico  
fonta aluminiu, acrilic  
valualumiini, akryyli  
barwione aluminium, akryl

**42** Anthrazit · anthracite

Excl. 1 x E27, max. 28 W

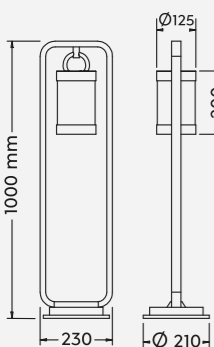
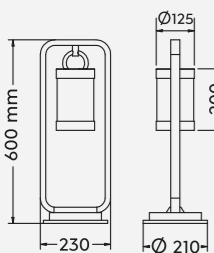
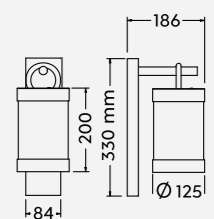

204160142



504160142

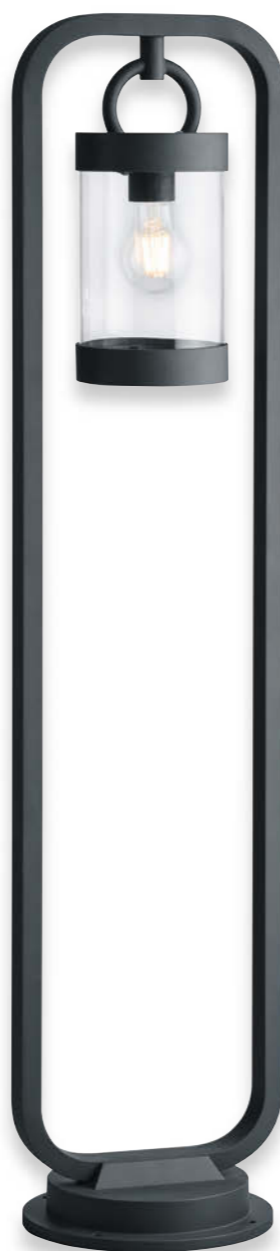

404160142

# SAMBESI

Aluminium Druckguss, Acryl  
diecast aluminium, acryl  
fonte d'aluminium, acryl  
gegoten aluminium, acryl  
aluminio fundido, acrílico  
pressofusione di alluminio, acrilico  
fonta aluminiu, acrilic  
valualumiini, akryyli  
barwione aluminium, akryl

**31** Weiß matt · white mat

Excl. 1 x E27, max. 28 W

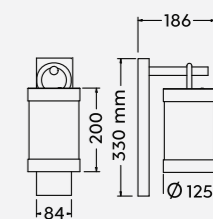

204160131

Empfohlen:  
recommended:

Filament LED  
E27, 4 W  
470 lm, 2.700 K



987-400



Dämmerungssensor per Schalter deaktivierbar

On and off switchable dusk sensor

Détecteur de crépuscule commutable

Aan en uit schakelbare schemeringsensor

Sensor de oscuridad conmutable on/off

Sensore crepuscolare commutabile on/off

senzor de lumina/amurg on/off

On/off kytkettävä hämärätunnistin

Czujnik zmierzchowy dezaktywowany przez przełącznika

Aç-kapa anahtarlı karanlık sensörü



Empfohlen:  
recommended:

Filament LED  
E27, 4 W  
470 lm, 2.700 K



987-400



# SAMBESI

Aluminium Druckguss, Acryl  
diecast aluminium, acryl  
fonte d'aluminium, acryl  
gegoten aluminium, acryl  
aluminio fundido, acrílico  
pressofusione di alluminio, acrilico  
fonta aluminiu, acrilic  
valualumiini, akryyli  
barwione aluminium, akryl

24 rostfarbig · rusty

Excl. 1 x E27, max. 28 W

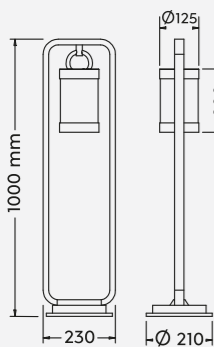
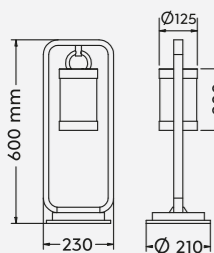
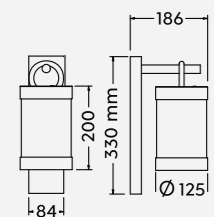

204160124



504160124

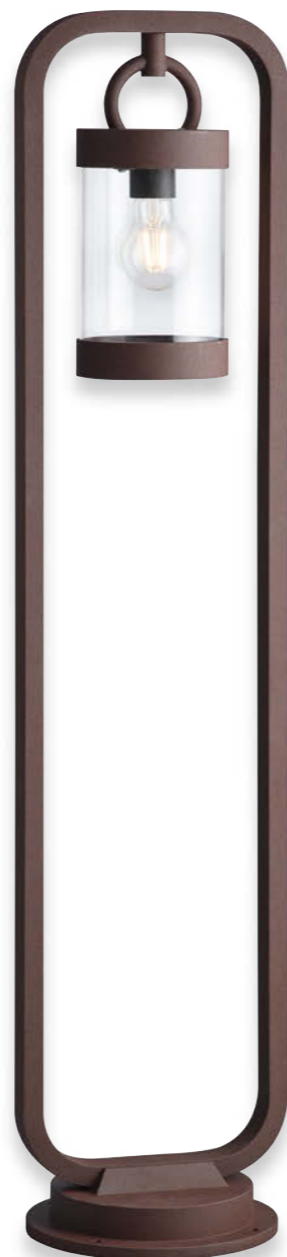

404160124

# SAMBESI

Aluminium Druckguss, Kunststoff  
diecast aluminium, plastic  
fonte d'aluminium, plastique  
gegoten aluminium, kunststof  
aluminio fundido, plástico  
pressofusione di alluminio, plastica  
fonta aluminiu, plastic  
valualumiini, muovi  
barwione aluminium, plastik

24 rostfarbig · rusty

31 Weiß matt · white mat

42 Anthrazit · anthracite

Excl. 1 x E27, max. 28 W

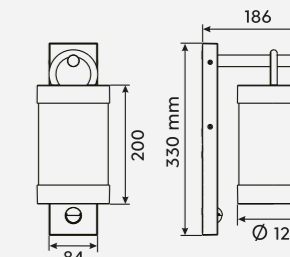

204169142



204169131

Empfohlen:  
recommended:

Filament LED  
E27, 4 W  
470 lm, 2.700 K



987-400



Dämmerungssensor per Schalter deaktivierbar  
On and off switchable dusk sensor  
Décteur de crépuscule commutable  
Aan en uit schakelbare schemeringsensor  
Sensor de oscuridad conmutable on/off  
Sensore crepuscolare commutabile on/off  
senzor de lumina/amurg on/off  
On/off kytkettävä hämärätunnistin  
Czujnik zmierzchowy dezaktywowany przez przełącznika  
Aç-kapa anahtarlı karanlık sensörü



Bewegungssensor  
Motion sensor  
Décteur de mouvement  
Bewegungssensor  
Sensor de movimiento  
Sensore di movimento  
Senzor de mişcare  
Liiketunnistin  
Czujnik ruchu

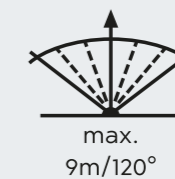

204169124



# CAVADO

Aluminium Druckguss, Kunststoff  
diecast aluminium, plastic  
fonte d'aluminium, plastique  
gegoten aluminium, kunststof  
aluminio fundido, plástico  
pressofusione di alluminio, plastica  
fonta aluminu, plastic  
valualumiini, muovi  
barwione aluminium, plastik

**31** Weiß matt · white mat  
**42** Anthrazit · anthracite

Excl. 1 x E27, max. 40 W

**211069131**  
**211069142**



Excl. 1 x E27, max. 40 W

**211060131**  
**211060142**  
**411060142**

Excl. 3 x E27, max. 40 W

**411060342**

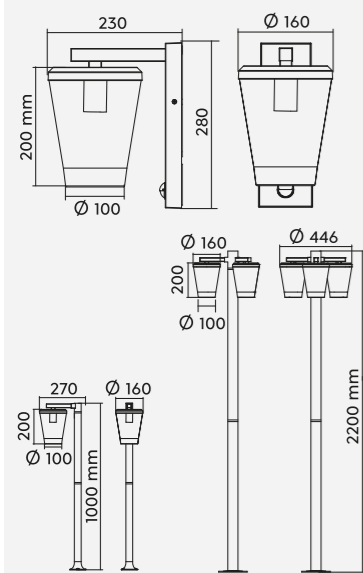

211069131



211069142



211060131



211060142



411060142



411060342

Empfohlen:  
recommended:

Filament LED  
E27, 4 W  
470 lm, 2.700 K



max.  
8m/120°





# TANARO

Aluminium Druckguss, Acryl  
 diecast aluminium, acryl  
 fonte d'aluminium, acryl  
 gegoten aluminium, acryl  
 aluminio fundido, acrílico  
 pressofusione di alluminio, acrilico  
 fonta aluminiu, acrilic  
 valualumiini, akryyli  
 barwione aluminium, akryl

**24** rostfarbig · rusty  
**42** Anthrazit · anthracite

Excl. 1 x E27, max. 40 W

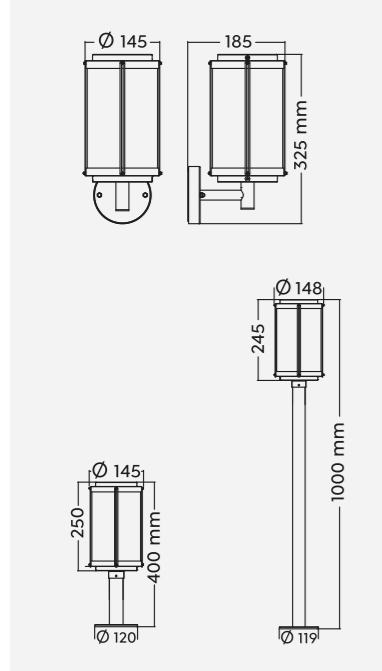

202360124



402360124



502360124



502360124



502360142



202360142

Empfohlen:  
 recommended:

Filament LED  
 E27, 4 W  
 470 lm, 2.700 K



987-400

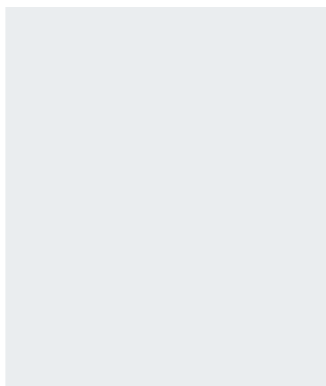
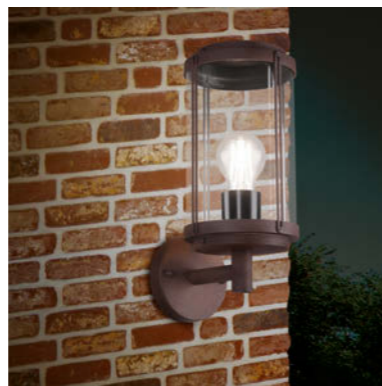



# TUELA

Aluminium Druckguss, Glas  
diecast aluminium, glass  
fonte d'aluminium, verre  
gegoten aluminium, glas  
aluminio fundido, vidrio  
pressofusione di alluminio, vetro  
fonta aluminiu, sticla  
valualumiini, lasi  
barwione aluminium, szkło

**24** rostfarbig · rusty  
**42** Anthrazit · anthracite

Excl. 1 x E27, max. 40 W

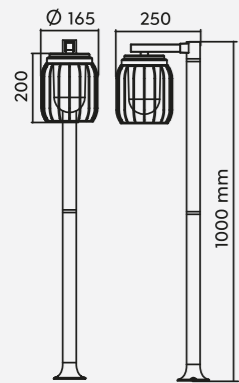
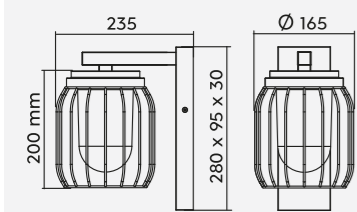

210860124



210860142



410860124

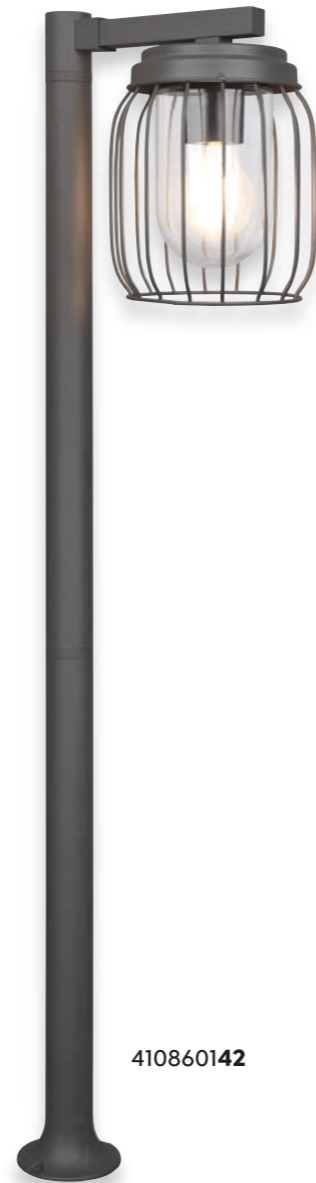

410860142



210869124

# TUELA

Aluminium Druckguss, Glas  
diecast aluminium, glass  
fonte d'aluminium, verre  
gegoten aluminium, glas  
aluminio fundido, vidrio  
pressofusione di alluminio, vetro  
fonta aluminiu, sticla  
valualumiini, lasi  
barwione aluminium, szkło

**24** rostfarbig · rusty  
**42** Anthrazit · anthracite

Excl. 1 x E27, max. 40 W

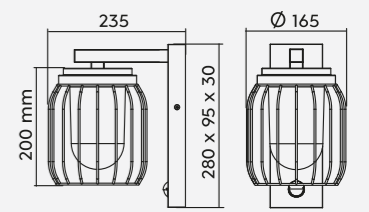

210869142

Empfohlen:  
recommended:

Filament LED  
E27, 4 W  
470 lm, 2.700 K



987-400

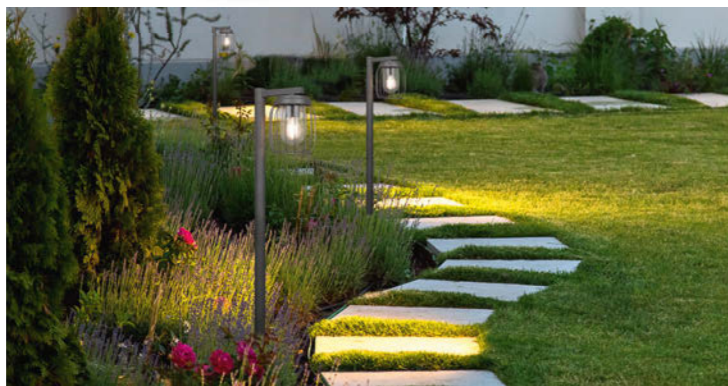

Bewegungssensor  
Motion sensor  
Décteur de mouvement  
Bewegingssensor  
Sensor de movimiento  
Sensore di movimento  
Senzor de mişcare  
Liiketunnistin  
Czujnik ruchu

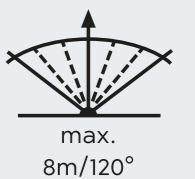
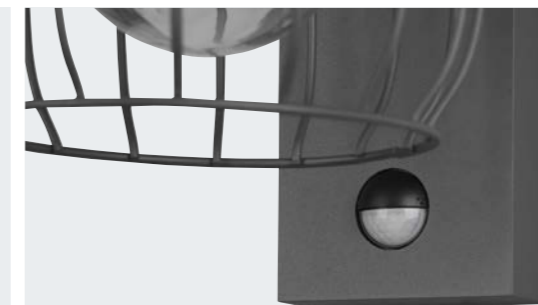



# BRENTA

Aluminium Druckguss, Glas  
 diecast aluminium, glass  
 fonte d'aluminium, verre  
 gegoten aluminium, glas  
 aluminio fundido, vidrio  
 pressofusione di alluminio, vetro  
 fonta aluminiu, sticla  
 valualumiini, lasi  
 barwione aluminium, szkło

**24** rostfarbig · rusty  
**42** Anthrazit · anthracite

Excl. 1 x E27, max. 40 W

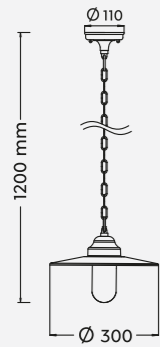

301760142



301760124

# BRENTA

Aluminium Druckguss, Glas  
 diecast aluminium, glass  
 fonte d'aluminium, verre  
 gegoten aluminium, glas  
 aluminio fundido, vidrio  
 pressofusione di alluminio, vetro  
 fonta aluminiu, sticla  
 valualumiini, lasi  
 barwione aluminium, szkło

**24** rostfarbig · rusty  
**42** Anthrazit · anthracite

Excl. 1 x E27, max. 40 W

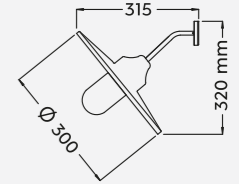

201760142



201760124

Empfohlen:  
 recommended:

Filament LED  
 E27, 4 W  
 470 lm, 2.700 K



987-400

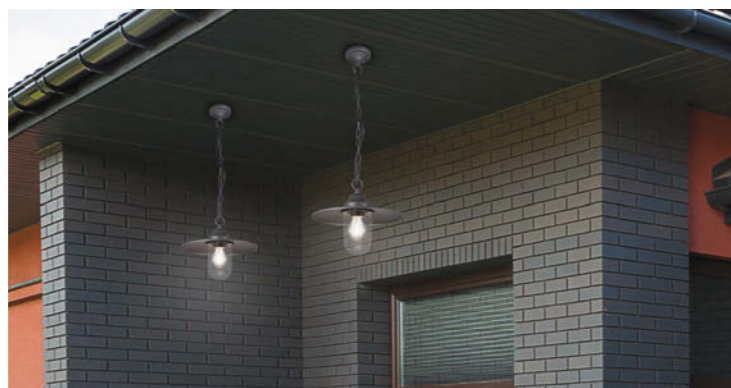

Empfohlen:  
 recommended:

Filament LED  
 E27, 4 W  
 470 lm, 2.700 K



987-400



# OLONA

Aluminium Druckguss, Glas  
diecast aluminium, glass  
fonte d'aluminium, verre  
gegoten aluminium, glas  
aluminio fundido, vidrio  
pressofusione di alluminio, vetro  
fonta aluminiu, sticla  
valualumiini, lasi  
barwione aluminium, szkło

**24** rostfarbig · rusty  
**42** Anthrazit · anthracite

Excl. 1 x E27, max. 20 W

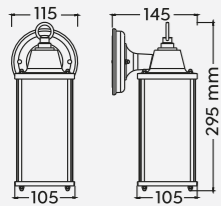

201960142



201960124

# DUERO

Aluminium Druckguss, Glas  
diecast aluminium, glass  
fonte d'aluminium, verre  
gegoten aluminium, glas  
aluminio fundido, vidrio  
pressofusione di alluminio, vetro  
fonta aluminiu, sticla  
valualumiini, lasi  
barwione aluminium, szkło

**24** rostfarbig · rusty  
**42** Anthrazit · anthracite

Excl. 1 x E27, max. 40 W

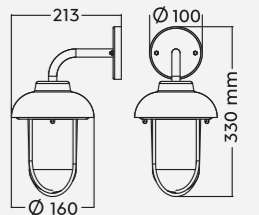

202760124



202760142

Empfohlen:  
recommended:

Filament LED  
E27, 4 W  
470 lm, 2.700 K



987-400

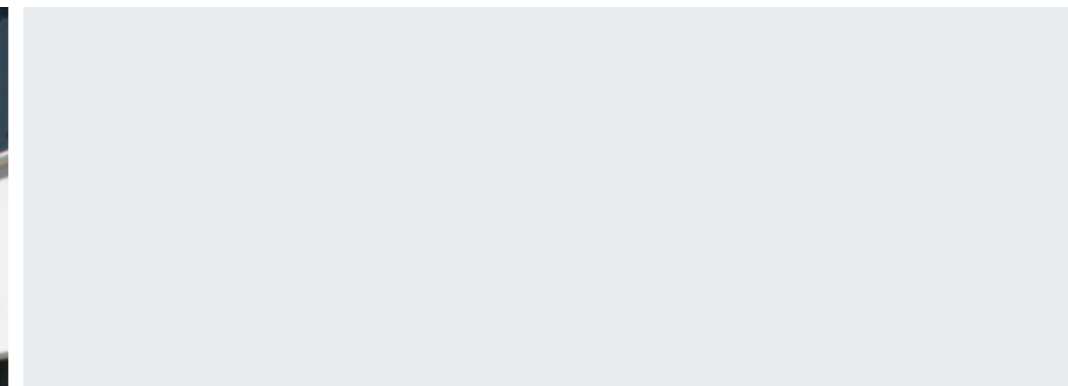

Empfohlen:  
recommended:

Filament LED  
E27, 4 W  
470 lm, 2.700 K



987-400

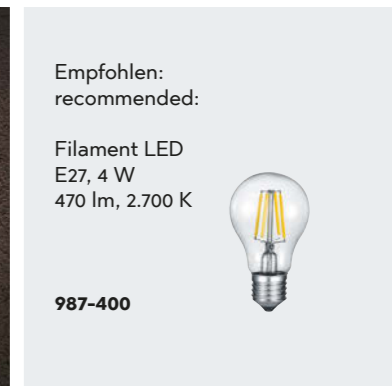



Bodeneinbaustrahler  
 Recessed floor lamps  
 Luminaire encastrés de sol  
 grond inbouwspot  
 Lámparas de pie empotradas  
 Incasso Calpestabili  
 Lampi incastrate in podea  
 upotetut maavalot  
 wpuszczone lampy podłogowe

07 Nickel matt · nickel mat

Incl. SMD-LED, 3,5 W  
 350 lm, 3.000 K

IP65

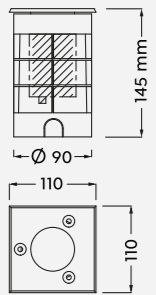
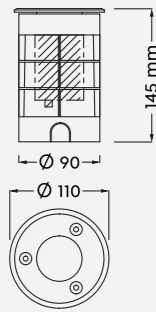

821660107



821660207

Bodeneinbaustrahler  
 Recessed floor lamps  
 Luminaire encastrés de sol  
 grond inbouwspot  
 Lámparas de pie empotradas  
 Incasso Calpestabili  
 Lampi incastrate in podea  
 upotetut maavalot  
 wpuszczone lampy podłogowe

07 Nickel matt · nickel mat

Incl. SMD-LED, 8 W  
 900 lm, 3.000 K

IP65

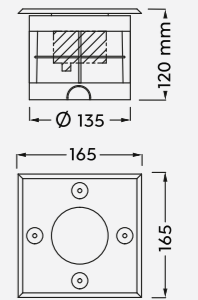
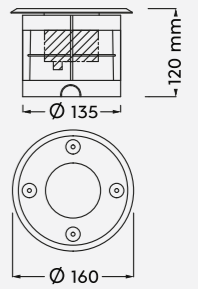

Abstrahlwinkel  
 Emission angle  
 Angle de rayonnement  
 Uitstraalhoek  
 Ángulo de emisión  
 Angolo di emissione  
 Unghiul de emisii  
 Säteilykulma  
 Kąt emisji



Belastbarkeit  
 Resilience  
 Limite de charge  
 Belastbaarheid  
 Resistencia  
 Resistenza  
 Rezistența la solicitare  
 Kuormitettavuus  
 Nośność



Abstrahlwinkel  
 Emission angle  
 Angle de rayonnement  
 Uitstraalhoek  
 Ángulo de emisión  
 Angolo di emissione  
 Unghiul de emisii  
 Säteilykulma  
 Kąt emisji



Belastbarkeit  
 Resilience  
 Limite de charge  
 Belastbaarheid  
 Resistencia  
 Resistenza  
 Rezistența la solicitare  
 Kuormitettavuus  
 Nośność



821669107



821669207



# UBANGI

Aluminium Druckguss  
 diecast aluminium  
 fonte d'aluminium  
 gegoten aluminium  
 aluminio fundido  
 pressofusione di alluminio  
 fonta aluminiu  
 valualumiini  
 barwione aluminium

**42** Anthrazit · anthracite

Excl. 1 x GU10, max. 28 W

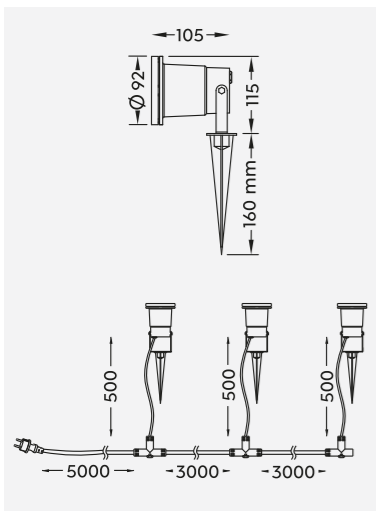

# MAREB

Aluminium Druckguss  
 diecast aluminium  
 fonte d'aluminium  
 gegoten aluminium  
 aluminio fundido  
 pressofusione di alluminio  
 fonta aluminiu  
 valualumiini  
 barwione aluminium

**42** Anthrazit · anthracite

Incl. 1 x SMD-LED, 11 W  
 1.000 lm, 3.000 K

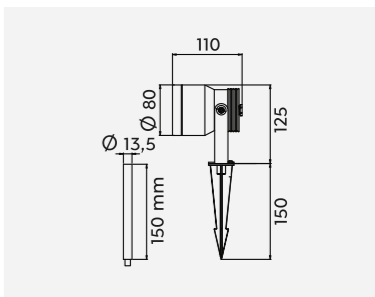

Empfohlen:  
 recommended:

LED GU10, 5 W  
 400 lm, 3.000 K  
 > 110°



955-50





# GARTENSTECKDOSEN · GARDEN SOCKETS

Polyresin  
polyresin  
polyresin  
polyresin  
poliresina  
poliestere  
polirasina  
polyresiini  
polyresin

11 Grau · grey

Zeitschaltuhr · timer  
max. 3.600 W

9961-11



max. 3.600 W

9962-11

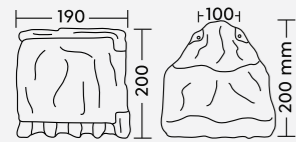

9961-11



9962-11



9964-42

Aluminium Druckguss  
diecast aluminium  
fonte d'aluminium  
gegoten aluminium  
aluminio fundido  
pressofusione di alluminio  
fonta aluminiu  
valualumiini  
barwione aluminium

42 Anthrazit · anthracite

max. 3.600 W

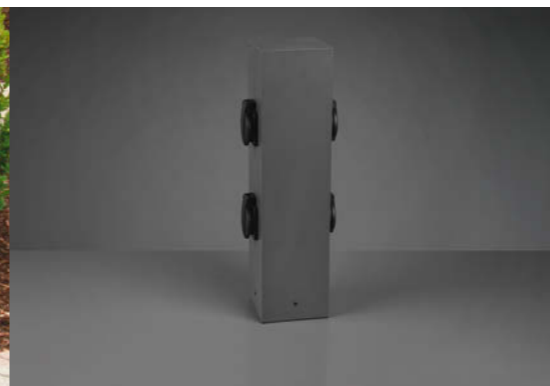
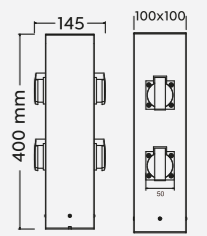



# UNIVERSAL-ERDSPIESS · GROUND SPIKE

Erdspieß, Edelstahl  
 Ground spike, steel  
 Piquet de terre, acier  
 Aardingspin, staal  
 Espiga, acero  
 Picchetto, acciaio  
 Țepușă pentru pământ, inox  
 Maapiikki, teräs  
 Żerdź, stal

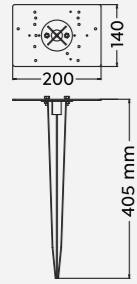

9960-07



# ECKBEFESTIGUNG · CORNER FASTENING

Eckbefestigung, Kunststoff  
 Corner fastening, plastic  
 Montage en angle, plastique  
 Hoekbevestiging, kunststof  
 Cantonera, plástico  
 Montaggio ad angolo, plastica  
 Fixare pentru colț, plastic  
 Kulmakiinnike, muovi  
 Okucie narożne, plastik

32 Schwarz matt · black mat

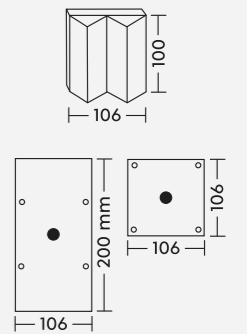

9965-32

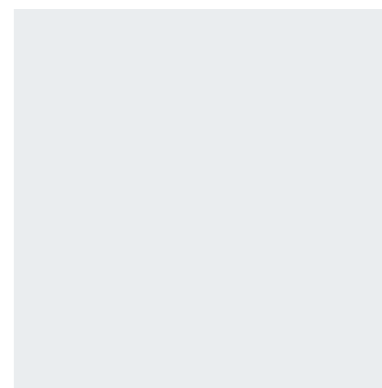
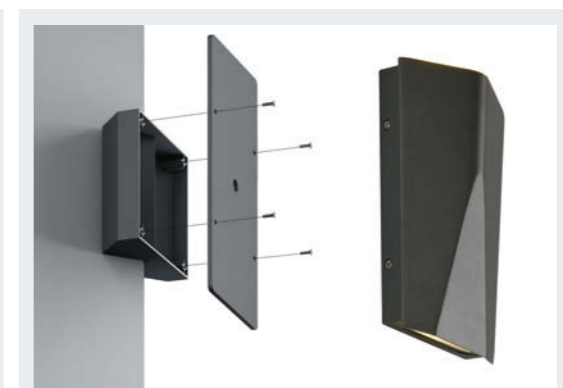
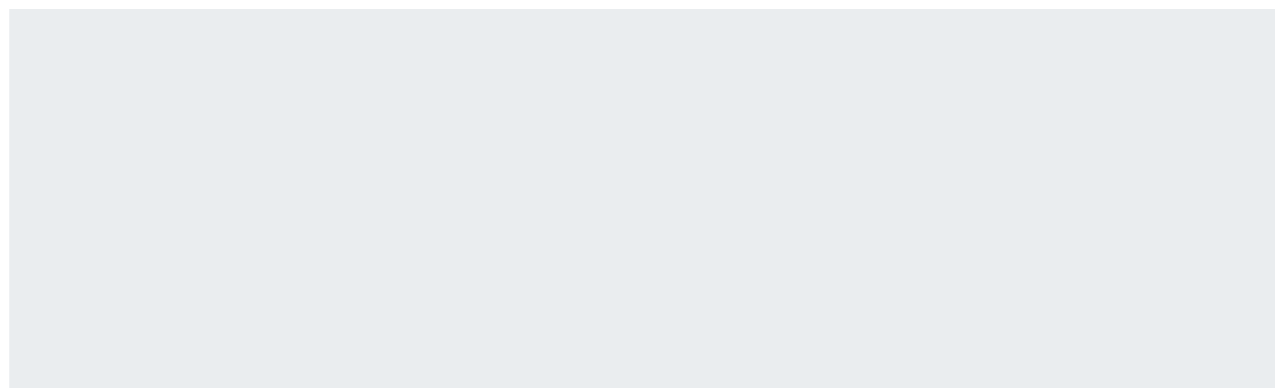



Kunststoff  
plastic  
plastique  
kunststof  
plástico  
plastica  
plastic  
muovi  
plastik

32 Schwarz matt · black mat

Incl. SMD-LED, 8 W  
800 lm, 3.000 K

IP54

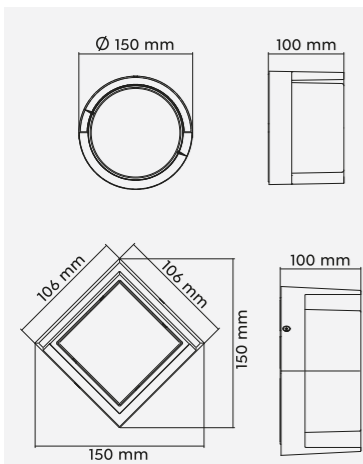

R27036132

R27026132

Edelstahl  
steel  
acier  
staal  
acero  
acciaio  
inox  
teräs  
stal

42 Anthrazit · anthracite

Excl. 2 x GU10, max. 10 W  
R20026242



Excl. 2 x GU10, max. 10 W  
R20026942



R20026942

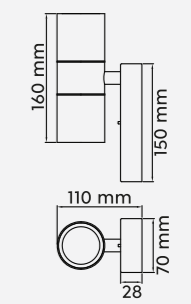
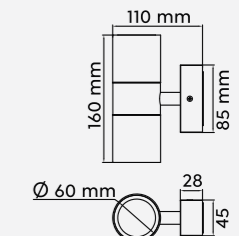

Dämmerungssensor  
Dusk sensor  
Décteur de crépuscule  
Schemeringsensor  
Sensor de oscuridad  
Sensore crepuscolare  
Senzor de lumina/amurg  
Hämärätunnistin  
Czujnik zmierzchowy



R20026242

Empfohlen:  
recommended:

LED GU10, 5 W  
400 lm, 3.000 K  
± 110°

955-50





# CORDOBA

Kunststoff  
 plastic  
 plastique  
 kunststof  
 plástico  
 plastica  
 plastic  
 muovi  
 plastik

**31** Weiß matt · white mat  
**32** Schwarz matt · black mat

Incl. 2 x SMD-LED, 2 W  
 2 x 200 lm, 3.000 K

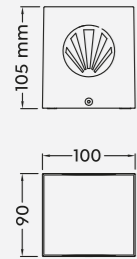

R28222631



R28222632

# ROSARIO

Kunststoff  
 plastic  
 plastique  
 kunststof  
 plástico  
 plastica  
 plastic  
 muovi  
 plastik

**31** Weiß matt · white mat  
**32** Schwarz matt · black mat

Incl. 2 x SMD-LED, 2 W  
 2 x 200 lm, 3.000 K

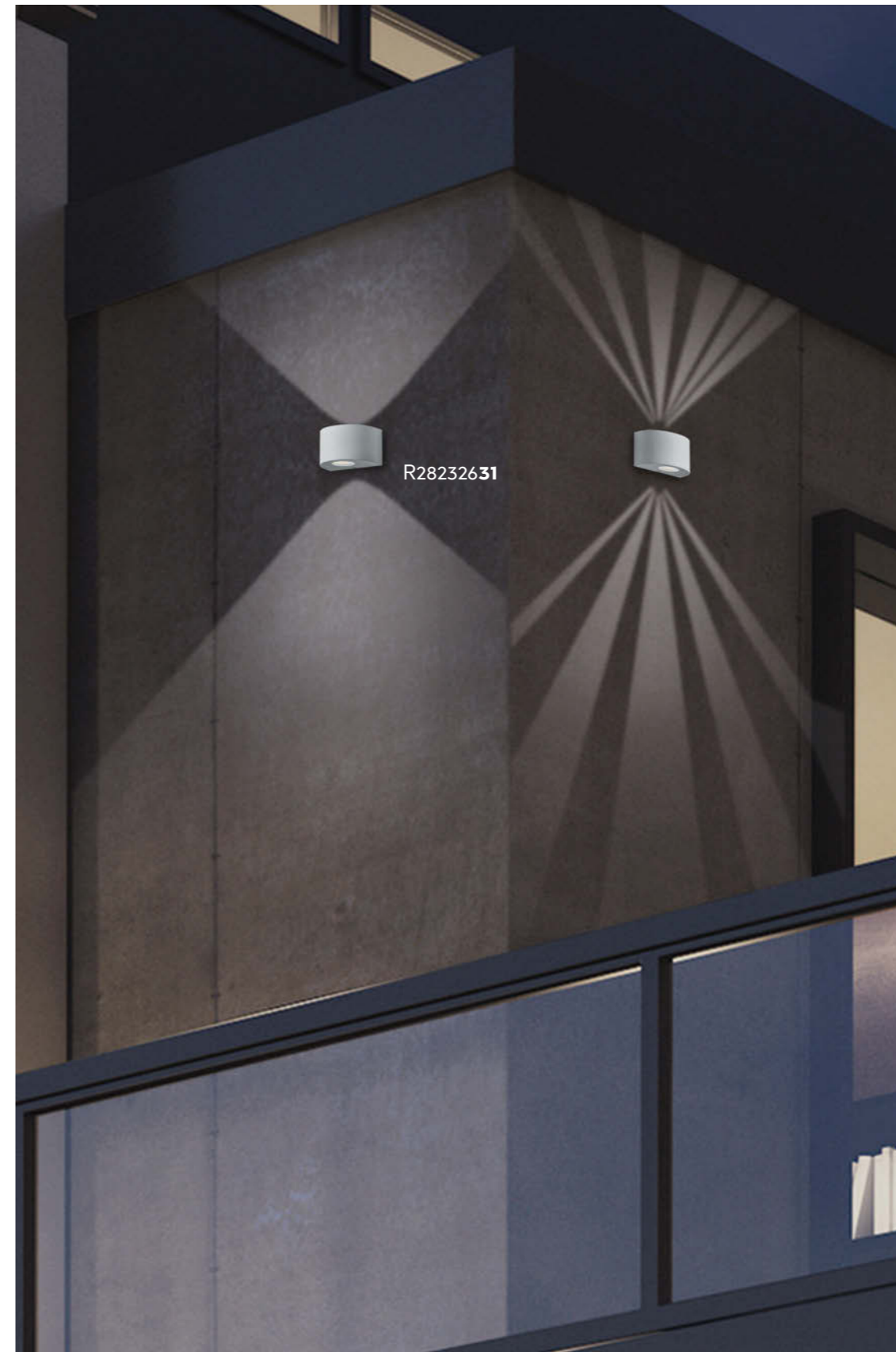
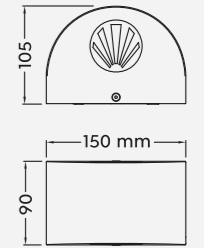

R28232632

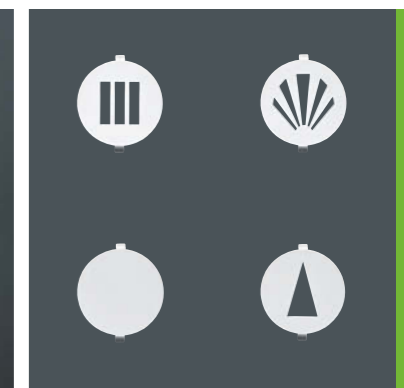
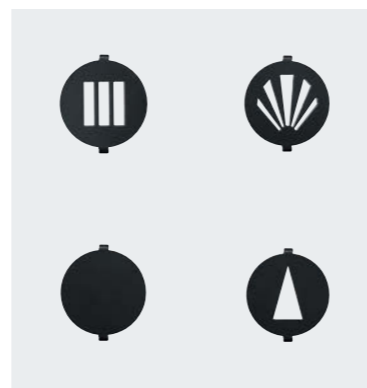
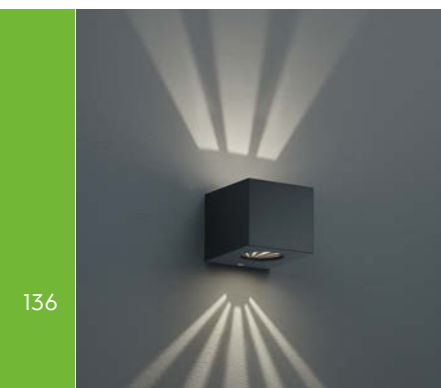



# MOLINA

Aluminium Druckguss, Kunststoff  
 diecast aluminium, plastic  
 fonte d'aluminium, plastique  
 gegoten aluminium, kunststof  
 aluminio fundido, plástico  
 pressofusione di alluminio, plastica  
 fonta aluminiu, plastic  
 valualumiini, muovi  
 barwione aluminium, plastik

**42** Anthrazit · anthracite

Incl. 2 x SMD-LED, 4,6 W  
 2 x 550 lm, 3.000 K

**IP54**

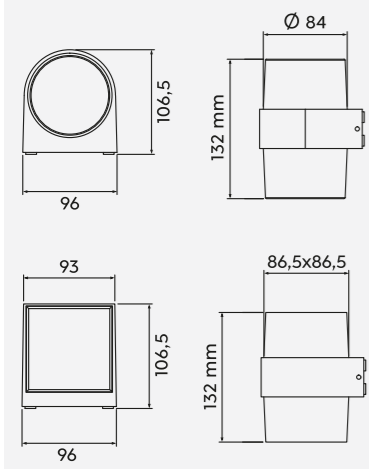

R22062142



R22052142



R24256232

# LIMEIRA

Kunststoff  
 plastic  
 plastique  
 kunststof  
 plástico  
 plastica  
 plastic  
 muovi  
 plastik

**32** Schwarz matt · black mat

Incl. 2 x SMD-LED, 3,5 W  
 2 x 380 lm, 3.000 K

**IP44**

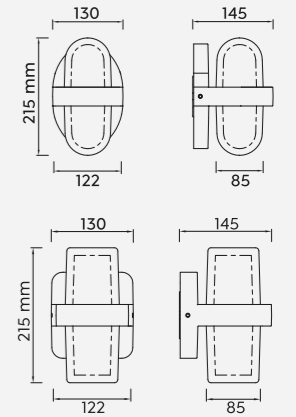

R24266232





# VENADO

Kunststoff  
plastic  
plastique  
kunststof  
plástico  
plastica  
plastic  
muovi  
plastik

**42** Anthrazit · anthracite

Incl. 1 x SMD-LED, 9,5 W  
1.000 lm, 3.000 K

IP54

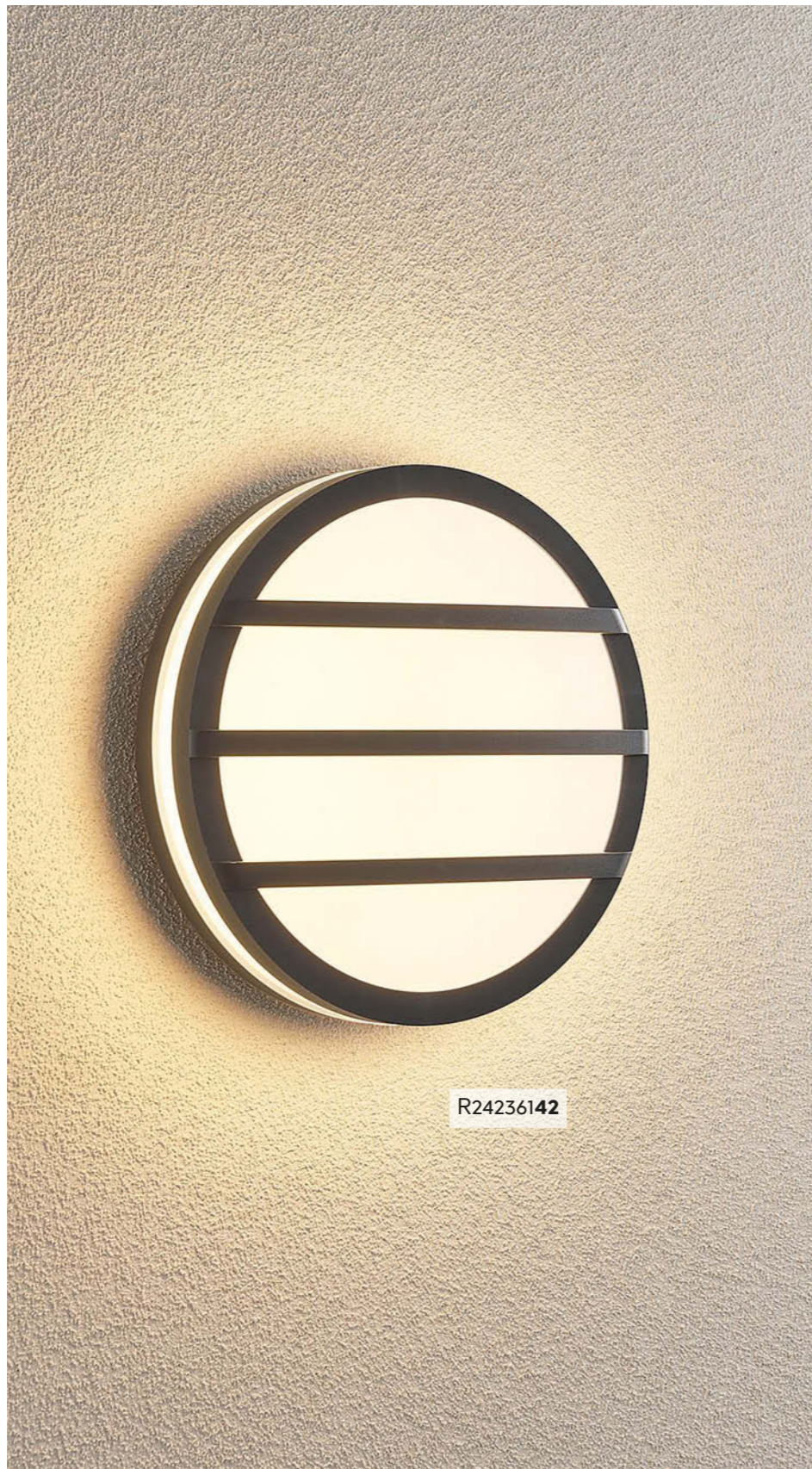
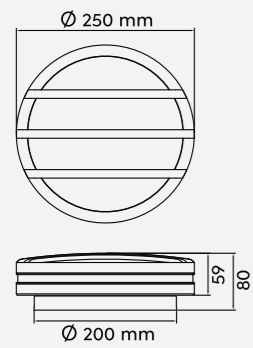

R24236142

# MORENA

Kunststoff  
plastic  
plastique  
kunststof  
plástico  
plastica  
plastic  
muovi  
plastik

**32** Schwarz matt · black mat

Incl. 1 x SMD-LED, 14 W  
1.500 lm, 2.300 + 3.000 + 4.000 K

IP54

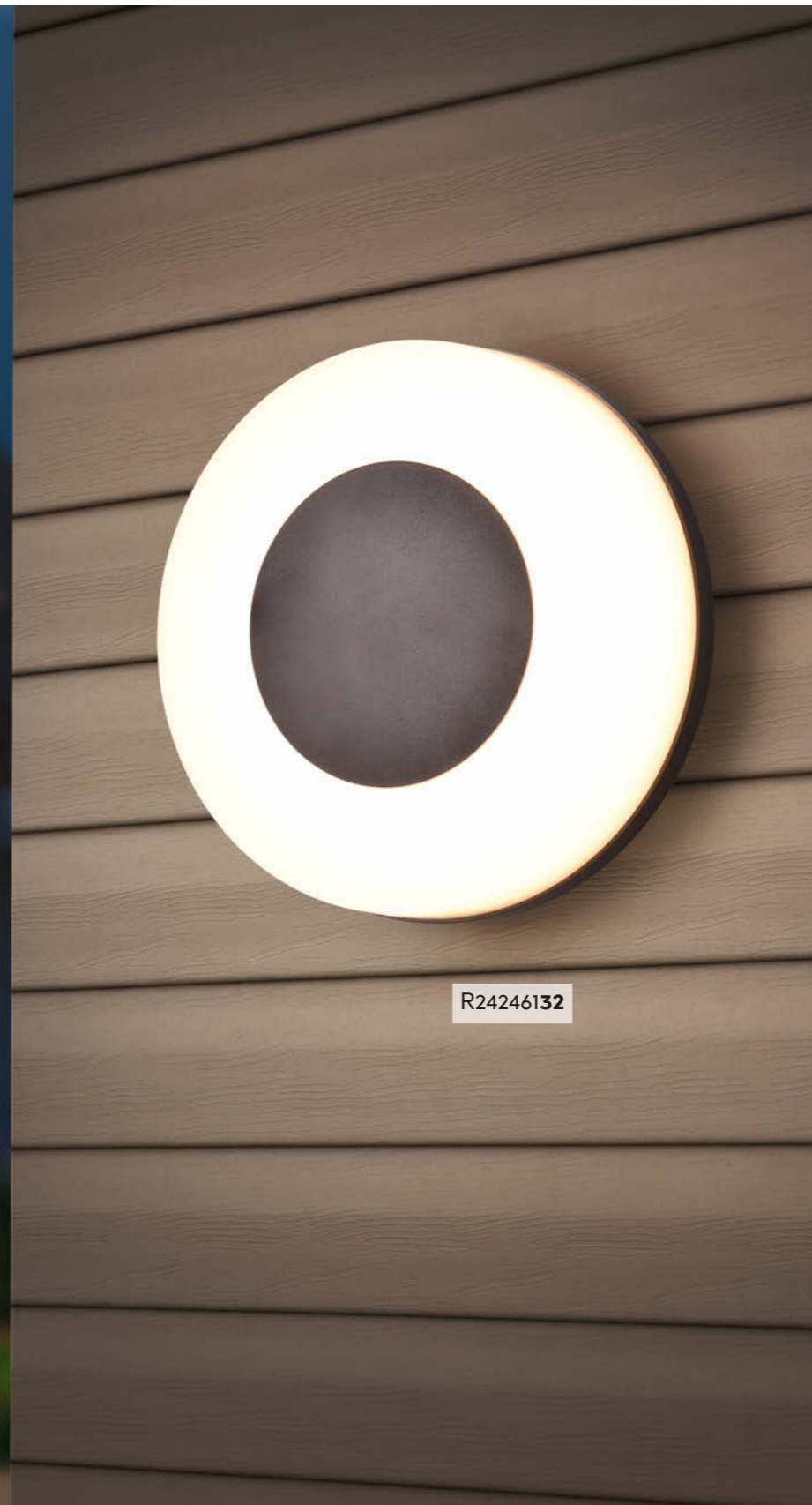
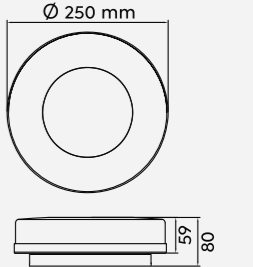

R24246132

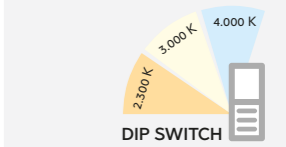

## DIP SWITCH

Lichtfarben direkt an der Leuchte einstellbar  
Colours directly adjustable at the lamp  
Les couleurs de la lumière peuvent être réglées directement sur le luminaire  
Lichtkleuren direct instelbaar op de lamp  
Tonalidades de luz ajustables directamente en la lámpara  
Colori della luce regolabili direttamente sulla lampada  
Culori ale luminii reglabile direct de la bec  
Valon väri asetettävissa suoraan valaisimesta  
Barwy światła można ustawić bezpośrednio na oprawie



2.300 K

3.000 K

4.000 K



# KENDAL

Kunststoff  
plastic  
plastique  
kunststof  
plástico  
plastica  
plastic  
muovi  
plastik

**31** Weiß matt · white mat  
**42** Anthrazit · anthracite

Incl. SMD-LED, 11 W  
1.180 lm, 3.000 K  
**R62151131**  
**R62151142**

IP54

Incl. SMD-LED, 12 W  
1.400 lm, 3.000 K  
**R22151131**  
**R22151142**

IP54

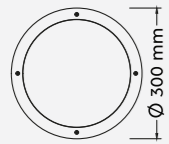

R62151131



R62151142



R22151131



R22151142

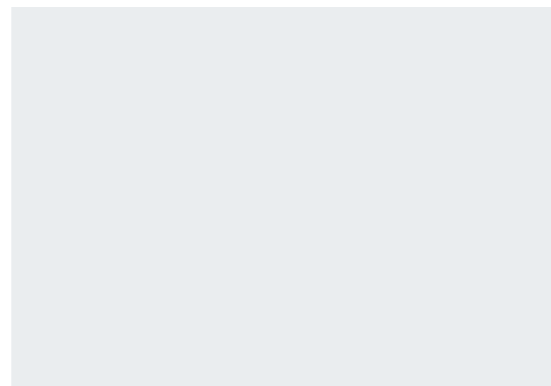



# CAMARO

Kunststoff  
plastic  
plastique  
kunststof  
plástico  
plastica  
plastic  
muovi  
plastik

**31** Weiß matt · white mat  
**42** Anthrazit · anthracite

Excl. 1 x E27, max. 12 W

R60501031  
R60501042

Excl. 2 x E27, max. 12 W

R60502031  
R60502042

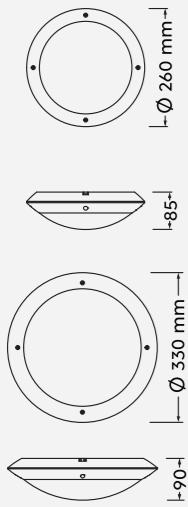

R60501031



R60501042



R60502031



R60502042

# PUELO

Aluminium Druckguss, Kunststoff  
diecast aluminium, plastic  
fonte d'aluminium, plastique  
gegoten aluminium, kunststof  
aluminio fundido, plástico  
pressofusione di alluminio, plastica  
fonta aluminiu, plastic  
valualumiini, muovi  
barwione aluminium, plastik

**31** Weiß matt · white mat  
**32** Schwarz matt · black mat

Excl. 1 x E27, max. 10 W

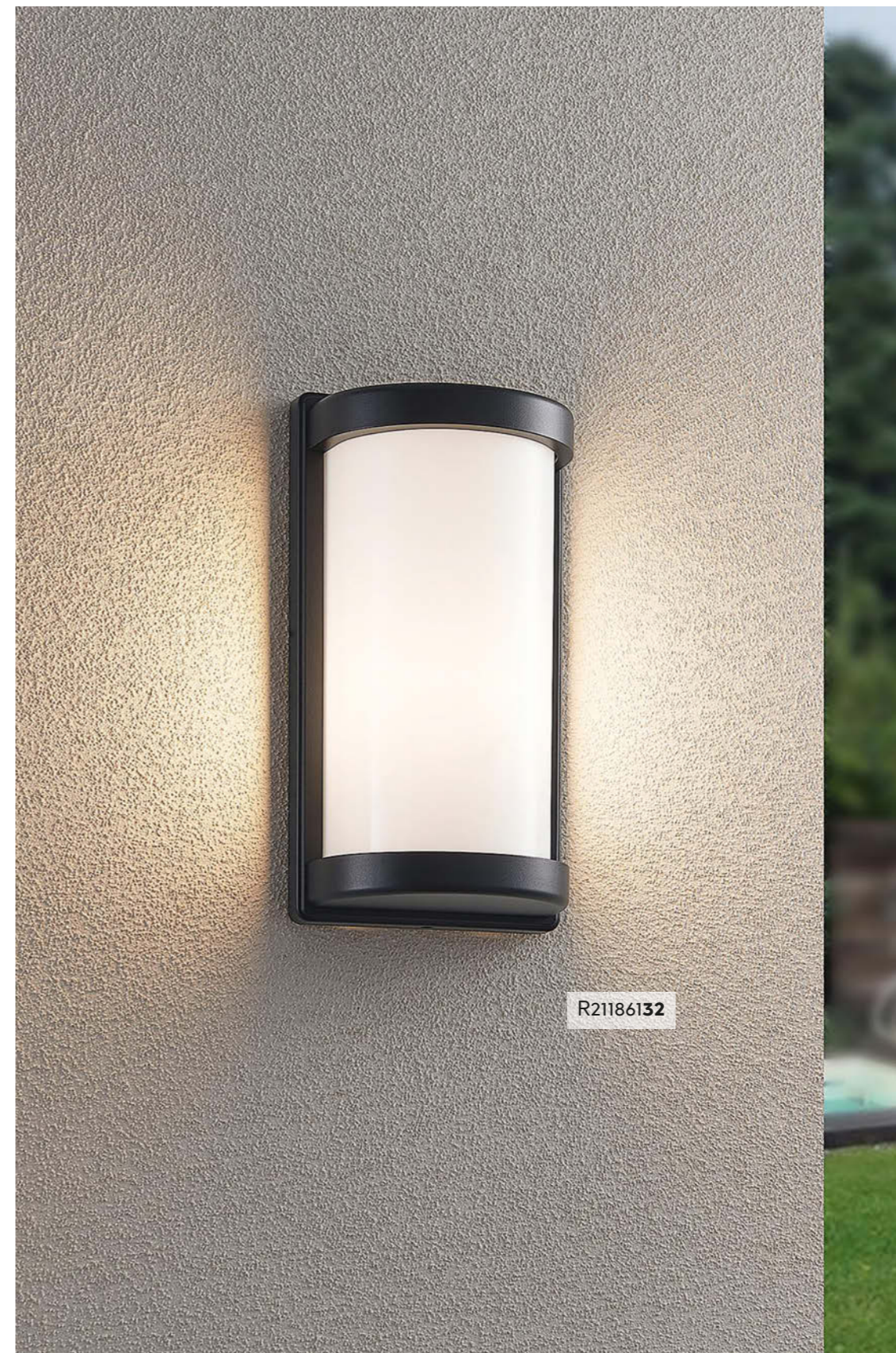
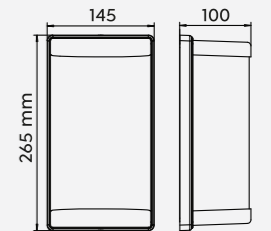

R21186132

Empfohlen:  
recommended:

LED E27, 4 W  
320 lm, 3.000 K



986-60

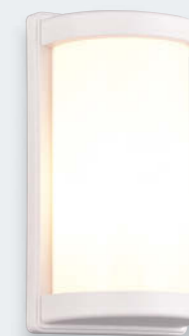

R21186131

Empfohlen:  
recommended:

LED E27, 4,9 W  
470 lm, 3.000 K



987-60





**Außenbeleuchtung ist viel mehr als nur funktional!**

Dank integriertem Akku sind die transportablen Leuchten flexibel und setzen spannende Akzente im Garten, auf dem Balkon oder der Terrasse - ganz ohne Kabel! Für die richtige Stimmung sorgen zusätzliche Highlights wie RGB-Farbwechsler oder Bluetooth-Funktion für kabelloses Musik hören. Die perfekte Beleuchtung für gemeinsame Abendstunden mit Familie und Freunden.

**Outdoor lighting is much more than just functional!**

Integrated rechargeable batteries lets you flexibly use these easily transportable lights to accent your garden, balcony or terrace in an exciting way, all without any cables! Additional highlights like an RGB colour wheels and Bluetooth for streaming music wirelessly provide just the right mood. The perfect lighting for spending evening hours with family and friends.

**L'éclairage extérieur est bien plus que simplement fonctionnel !**

Grâce à la batterie rechargeable intégrée, les lampes transportables sont flexibles et mettent des accents excitants dans le jardin, sur le balcon ou la terrasse –

sans aucun câble ! D'autres fonctions marquantes garantissent une bonne ambiance, telles que le changeur de couleurs RVB ou la fonction Bluetooth pour l'écoute de musique sans fil. L'éclairage parfait pour les soirées partagées avec la famille et les amis.

**Buitenverlichting is veel meer dan enkel nuttig!**

Dankzij de geïntegreerde accu zijn de verplaatsbare lampen flexibel en zorgen voor mooie accenten in de tuin, op het balkon of op het terras, en dat helemaal zonder kabel! Voor de juiste stemming zorgen extra hoogtepunten zoals de RGB-kleurenwisselaar of Bluetooth-functie om draadloos muziek te beluisteren. De perfecte verlichting om 's avonds aangenaam te vertoeven met vrienden en familie.

**¡La iluminación exterior es mucho más que algo funcional!**

Gracias a la batería integrada, las luces transportables son flexibles y aportan puntos de atención excitantes al jardín, al balcón o a la terraza - ¡y sin ningún tipo de cables! Se consigue el ambiente adecuado con otras características especiales adicionales como el modificador de color RGB o la función Bluetooth para escuchar música sin cables. La iluminación perfecta para pasar la tarde con la familia y los amigos.

**L'illuminazione esterna è molto più che funzionale!**

Grazie alla batteria ricaricabile integrata, le lampade portatili sono flessibili e creano accenti emozionanti in giardino, sul balcone o sulla terrazza - senza cavi! Ulteriori punti di forza come il cambiacolori RGB o la funzione Bluetooth per l'ascolto di musica senza fili assicurano il giusto feeling. L'illuminazione perfetta per le ore serali da trascorrere insieme alla famiglia e agli amici.

**Iluminarea exterioară este mult mai mult decât funcțională!**

Datorită acumulatorului integrat, lămpile transportabile sunt flexibile și oferă un aspect atrăgător în grădină, pe balcon sau pe terasă - fără cablu! Atmosfera potrivită este asigurată de jocurile suplimentare de lumină cum ar fi schimbarea culorilor RGB sau funcția Bluetooth pentru a asculta muzică fără cablu. Iluminarea perfectă pentru orele de seară cu familia și prietenii.

**Ulkovalaistus on paljon muutakin kuin vain toimintaa!**

Integroidun ladattavan akun ansiosta siirrettävät valaisimet ovat joustavia ja muodostavat jännittäviä korostuksia puutarhaan, parvekkeelle tai terassille – ilman kaapeleita! Lisäkorostukset, kuten RGB-värienvaihtajat tai Bluetooth-toiminto langattomaan musiikin kuuntelun, takaavat oikean ilmapiirin. Täydellinen valaistus illanviettoon yhdessä perheen ja ystävien kanssa.

**Oświetlenie zewnętrzne to znacznie więcej niż tylko funkcjonalność!**

Dzięki akumulatorowi przenośne lampy są elastyczne w ustawieniu i tworzą ekscytujące akcenty w ogrodzie, na balkonie lub tarasie - bez żadnych kabli! Odpowiedni nastrój zapewnią dodatkowe urządzenia, takie jak zmieniające kolorów RGB lub funkcja Bluetooth do bezprzewodowego słuchania muzyki. Doskonałe oświetlenie wspólnych wieczorów z rodziną i przyjaciółmi.



# PALMAS

Kunststoff  
plastic  
plastique  
kunststof  
plástico  
plastica  
plastic  
muovi  
plastik

01 Weiß · white

Incl. 1 x RGBW-LED, 1,5 W  
45 lm, 3.000 K

R55101101

Incl. 1 x RGBW-LED, 3 W  
90 lm, 3.000 K

R45101101

Incl. 1 x RGBW-LED, 4,5 W  
120 lm, 3.000 K

R45101901

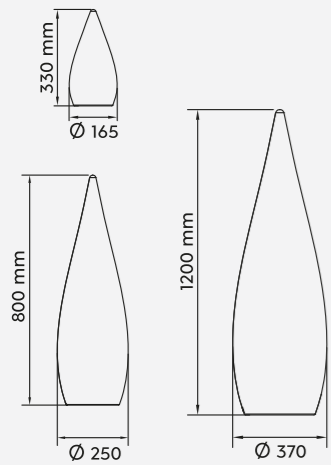

R55101101



R45101101



R45101901



RGBW Farbwechsler  
RGBW Colorchanging  
Changement de couleur RGBW  
RGBW Kleurverandering  
Cambio de color RGBW  
Cambia colore RGBW  
Schimbator de culoare RGBW  
Värinvaihto RGB  
Zmieniający kolor RGBW



Akkubetrieb  
Rechargeable battery operated  
Fonctionnement sur batteries rechargeable  
Oplaadbare accu  
Bateria recargable  
Bateria Ricaricabile  
Operabil prin baterie reincarcabila  
Ladattava akku  
Akumulator zasilany bateryjnie  
Şarj edilebilir pilli



Ladezeit  
Charging time  
Temps de charge  
Oplaaadtijd  
Tiempo de carga  
Tempo di carica  
Timp de incarcare  
Latausaika  
Czas ładowania



Leuchtdauer  
Luminous period  
Durée d'éclairage  
Brandtijd  
Tiempo de iluminación  
Tempo di durata  
Perioada de iluminare  
Valaistus aika  
Czas świecenia



# SANCHEZ

Kunststoff  
 plastic  
 plastique  
 kunststof  
 plástico  
 plastica  
 plastic  
 muovi  
 plastik

**31** Weiß matt · white mat  
**42** Anthrazit · anthracite

Incl. 1 x SMD-LED, 2,1 W  
 450 lm, 3.000 + 4.000 + 5.000 K

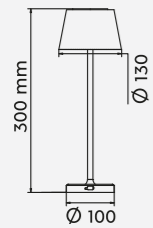

R54126131



R54126142



3.000 K

4.000 K

5.000 K



USB-C Anschluss mit Ladefunktion  
 Recharging USB-C connection  
 Entrée USB-C de rechargement  
 Opladende USB-C aansluiting  
 Conexión USB-C de recarga  
 Connessione USB-C di ricarica  
 Conexiune USB-C reîncărcare  
 Lataaminen USB-C-liitäntä  
 ładowania USB-C połączenie





# MARTINEZ

Metall, Kunststoff  
metal, plastic  
metale, plastique  
metaal, kunststof  
metal, plástico  
metallo, plastica  
metal, plastic  
metalli, muovi  
metal, plastik

- 31** Weiß matt · white mat
- 32** Schwarz matt · black mat
- 77** Ultimate Grau · ultimate grey
- 83** Illuminate Gelb · illuminate yellow

Incl. 1 x SMD-LED, 2,2 W  
250 lm, 2.700 - 6.500 K

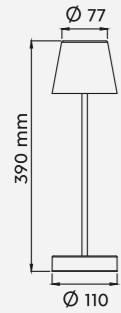

R54086132

R54086131



R54086183

R54086177

# FERNANDEZ

Metall, Kunststoff  
metal, plastic  
metale, plastique  
metaal, kunststof  
metal, plástico  
metallo, plastica  
metal, plastic  
metalli, muovi  
metal, plastik

- 31** Weiß matt · white mat
- 32** Schwarz matt · black mat

Incl. 1 x SMD-LED, 1,5 W  
130 lm, 2.700 + 4.000 + 6.000 K

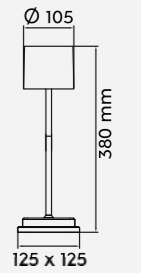

R54096131

R54096132

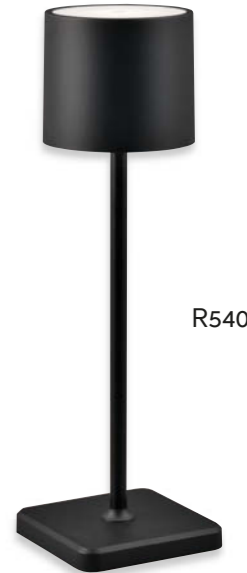

Lichtfarbe stufenlos einstellbar  
Light color infinitely variable  
Couleur de lumière infiniment variable  
Lichtkleur traploos instelbaar  
Color de luz infinitamente variable  
Colore della luce infinitamente variabile  
Culoare lumină infinit variabilă  
Valon väri portaattomasti  
Jasny kolor bezstopniowo



Lichtfarbe einstellbar  
Adjustable light color  
Couleur de lumière réglable  
Lichtkleur instelbaar  
Color de luz regulable  
Colore della luce regolabile  
Lumina colorata reglabila  
Väriämpötila säädettävissä  
Regulowana barwa światła



USB-C Anschluss mit Ladefunktion  
Recharging USB-C connection  
Entrée USB-C de rechargement  
Opladende USB-C aansluiting  
Conexión USB-C de recarga  
Connessione USB-C di ricarica  
Conexiune USB-C reîncărcare  
Lataaminen USB-C-liitäntä  
Ładowania USB-C połączenie





# ELLIOT

Kunststoff  
plastic  
plastique  
kunststof  
plástico  
plastica  
plastic  
muovi  
plastik

- 31** Weiß matt · white mat
- 32** Schwarz matt · black mat
- 49** Pistaziengrün · pistachio green
- 77** Ultimate Grau · ultimate grey
- 83** Illuminate Gelb · illuminate yellow

Incl. 1 x SMD-LED, 2 W  
180 lm, 3.000 K

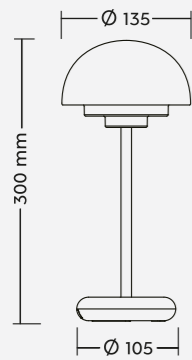

# LENNON

Kunststoff  
plastic  
plastique  
kunststof  
plástico  
plastica  
plastic  
muovi  
plastik

- 01** Weiß · white
- 02** Schwarz · black
- 49** Pistaziengrün · pistachio green
- 77** Ultimate Grau · ultimate grey
- 83** Illuminate Gelb · illuminate yellow

Incl. 1 x SMD-LED, 2 W  
180 lm, 3.000 K

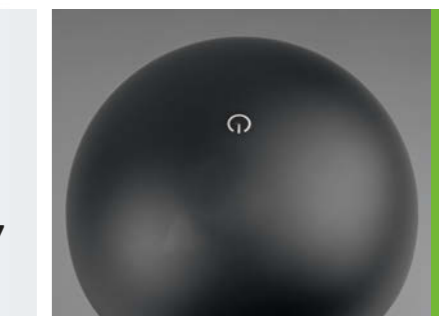
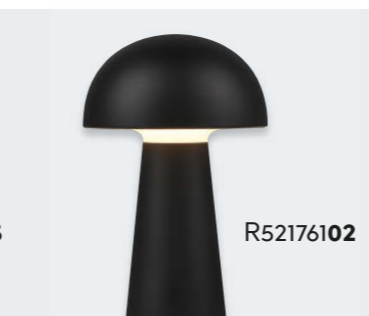
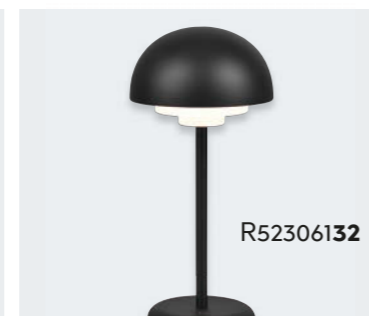
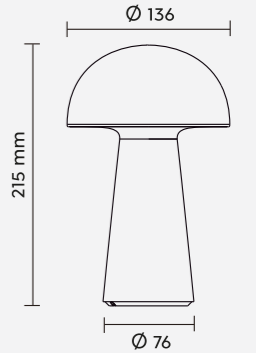



# ARUBA

Kunststoff  
plastic  
plastique  
kunststof  
plástico  
plastica  
plastic  
muovi  
plastik

01 Weiß · white

Incl. 1 x RGBW-LED, 1 W  
70 lm, 3.000 K

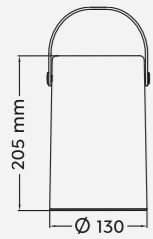

R57080101



R55086101

# JAMAICA

Kunststoff  
plastic  
plastique  
kunststof  
plástico  
plastica  
plastic  
muovi  
plastik

01 Weiß · white

Incl. 1 x RGBW-LED, 2,5 W  
25 lm, 3.000 K

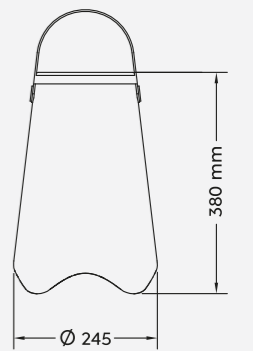

## LIGHT & SOUND



USB Anschluss mit Ladefunktion  
Recharging USB connection  
Entrée USB de rechargement  
Opladende USB aansluiting  
Conexión USB de recarga  
Connessione USB di ricarica  
Conexiune USB reîncărcare  
Lataaminen USB-liitäntä  
Ładowania USB połączenie  
şarj USB bađlantı



Ladezeit  
Charging time  
Temps de charge  
Oplaadtijd  
Tiempo de carga  
Tempo di carica  
Timp de încarcare  
Latausaika  
Czas ładowania



Leuchtdauer  
Luminous period  
Durée d'éclairage  
Brandtijd  
Tiempo de iluminación  
Tempo di durata  
Perioada de iluminare  
Valaistusaika  
Czas świecenia

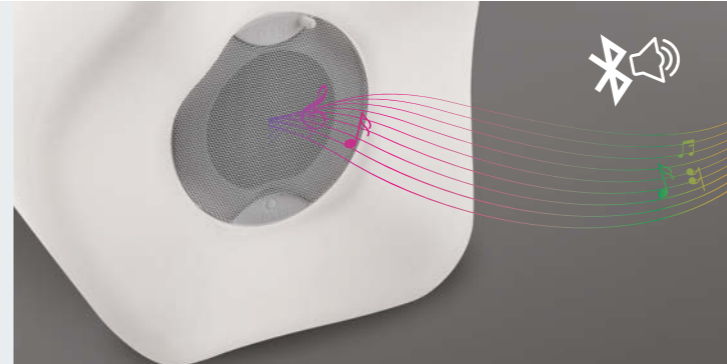



Kunststoff  
plastic  
plastique  
kunststof  
plástico  
plastica  
plastic  
muovi  
plastik

01 Weiß · white

Incl. 1 x SMD-LED, 1,5 W  
90 lm, 3.000 K

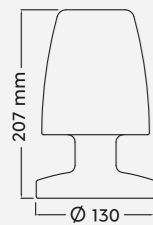

R57051101

Kunststoff  
plastic  
plastique  
kunststof  
plástico  
plastica  
plastic  
muovi  
plastik

01 Weiß · white

Incl. 1 x SMD-LED, 1,5 W  
90 lm, 3.000 K

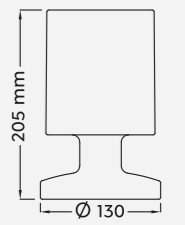

R57071101



Ladezeit  
Charging time  
Temps de charge  
Oplaaftijd  
Tiempo de carga  
Tempo di carica  
Timp de incarcare  
Latausaika  
Czas ładowania



Leuchtdauer  
Luminous period  
Durée d'éclairage  
Brandtijd  
Tiempo de iluminación  
Tempo di durata  
Perioada de iluminare  
Valaistusaika  
Czas świecenia



Akkubetrieb  
Rechargeable battery operated  
Fonctionnement sur batteries rechargeable  
Oplaadbare accu  
Batería recargable  
Batteria Ricaricabile  
Operabil prin baterie reincarcabila  
Ladattava akku  
Akumulator zasilany baterijnie



USB Anschluss mit Ladefunktion  
Recharging USB connection  
Entrée USB de rechargement  
Opladende USB aansluiting  
Conexión USB de recarga  
Connessione USB di ricarica  
Conexiune USB reîncărcare  
Lataaminen USB-liitäntä  
Ładowania USB połączenie



# BOLO

Kunststoff  
plastic  
plastique  
kunststof  
plástico  
plastica  
plastic  
muovi  
plastik

01 Weiß · white

Excl. 1 x E27, max. 23 W

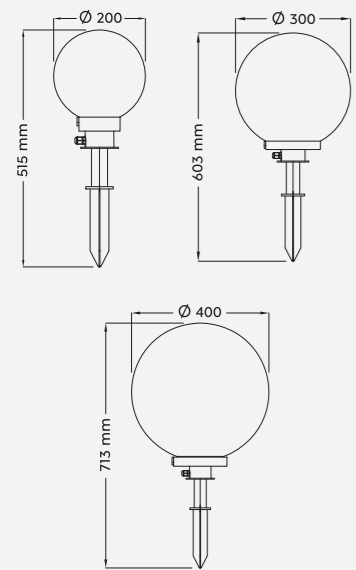

R57043001



R57042001



R57044001



Empfohlen:  
recommended:

LED E27, 4,9 W  
470 lm, 3.000 K



987-60







**Sonne Tanken!**

Solarleuchten nutzen ausschließlich die Kraft der Sonne um Licht zu erzeugen. Dabei sind sie extrem umweltschonend, sparsam und gleichermaßen praktisch, da sie weder Steckdosen noch einen Anschluss ans Stromnetz benötigen. In Kombination mit moderner LED-Technik bieten Solarleuchten ideales Licht für Haus und Garten.

**Soak up the sun!**

Solar lamps exclusively use the power of the sun to generate light. At the same time they are extremely environmentally friendly and economical as well as practical, as they need neither sockets nor a connection to the mains supply. In combination with modern LED technology, solar lamps provide an ideal light for home and garden.

**Faites le plein de soleil !**

Les lampes solaires utilisent exclusivement l'énergie du soleil pour générer de la lumière. En même temps, elles sont extrêmement écologiques, économiques et tout aussi pratiques, car elles ne nécessitent ni prise de courant ni raccordement au réseau électrique. En combinaison avec la technologie LED moderne, les lampes solaires fournissent une lumière idéale pour la maison et le jardin.

**Doe zon op!**

Zonnelampen maken uitsluitend gebruik van de kracht van de zon om licht te produceren. Daarbij zijn ze extreem milieuvriendelijk, zuinig en in gelijke mate praktisch, omdat ze noch een stopcontact noch een aansluiting op het stroomnet nodig hebben. In combinatie met moderne ledtechniek bieden zonnelampen ideaal licht voor huis en tuin.

**¡Disfrute del sol!**

Las luces solares usan exclusivamente la energía del sol para generar luz. Al mismo tiempo, son extremadamente ecológicas, económicas e igualmente prácticas, y no necesitan ni enchufes ni conexión a la corriente. En combinación con las modernas técnicas LED, las luces solares ofrecen una luz ideal para la casa y el jardín.

**Prendete un po' di sole!**

Le lampade solari utilizzano esclusivamente la potenza del sole per generare luce. Allo stesso tempo sono estremamente rispettose dell'ambiente, economiche e pratiche in quanto non richiedono né presa di corrente, né un collegamento alla rete elettrica. In combinazione con la moderna tecnologia LED, le lampade solari forniscono una luce ideale per la casa e il giardino.

**Alimentați cu soare!**

Lămpile solare se folosesc în exclusivitate de energia soarelui pentru a genera lumină. În acest context sunt extrem de ecologice, economice și practice în același timp, deoarece nu necesită nici prize și nici conectarea la o rețea electrică. În combinație cu tehnologia modernă LED, lămpile solare oferă lumină ideală pentru casă și grădină.

**Ajattele aurinkoa!**

Aurinkovalaisimet käyttävät auringon energiaa valon tuottamiseen. Samalla ne ovat erittäin ympäristöystävällisiä, taloudellisia ja myös käytännöllisiä, koska ne eivät vaadi pistorasioita tai liitäntää sähköverkkoon. Yhdessä modernin LED-tekniikan kanssa aurinkovalaisimet tarjoavat ihanteellisen valaistuksen kotiin ja puutarhaan.

**Nałapać energii słonecznej!**

Lampy solarne wykorzystują moc słońca do generowania światła. Są one przy tym niezwykle przyjazne dla środowiska, ekonomiczne i jednocześnie praktyczne, ponieważ nie wymagają gniazd ani podłączenia do sieci elektrycznej. W połączeniu z nowoczesną technologią LED lampy solarne zapewniają idealne oświetlenie domu i ogrodu.



# CARMO

Aluminium Druckguss, Kunststoff  
diecast aluminium, plastic  
fonte d'aluminium, plastique  
gegoten aluminium, kunststof  
aluminio fundido, plástico  
pressofusione di alluminio, plastica  
fonta aluminiu, plastic  
valualumiini, muovi  
barwione aluminium, plastik

32 Schwarz matt · black mat

Incl. 1 x SMD-LED, 2 W  
130 lm, 3.000 K

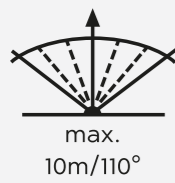
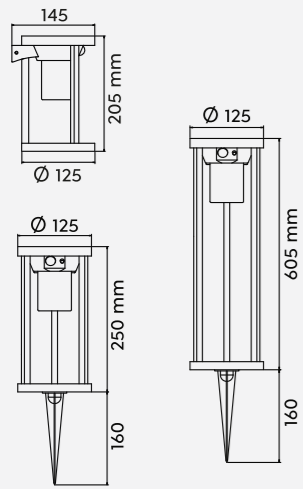
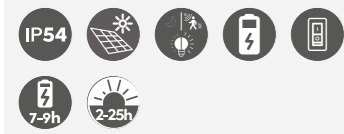

241069132



541069132

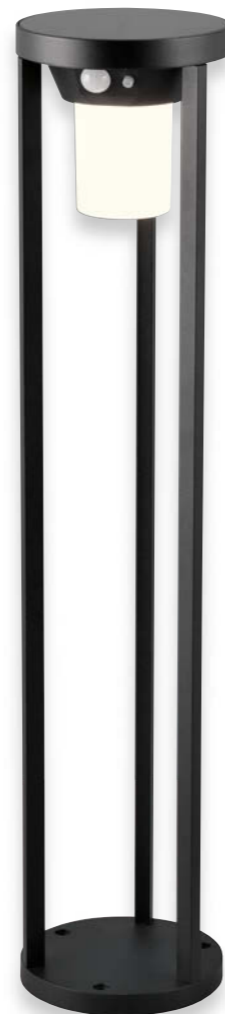

441069132



Bewegungssensor und Orientierungslicht  
Motion sensor and orientation light  
Capteur de mouvement et lumière d'orientation  
Bewegingssensor en oriëntatielicht  
Lámpara con sensor de movimiento y de orientación  
Sensore di movimento e luce di orientamento  
Senzor de mișcare și lumină de orientare  
Liiketunnistin ja suuntavalo  
Czujnik ruchu i światło orientacyjne





# POSADAS



Kunststoff  
plastic  
plastique  
kunststof  
plástico  
plastica  
plastic  
muovi  
plastik

42 Anthrazit · anthracite

Incl. 1 x SMD-LED, 4,5 W  
290 lm, 3.000 K



R22251142



R42251142

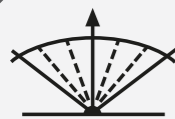
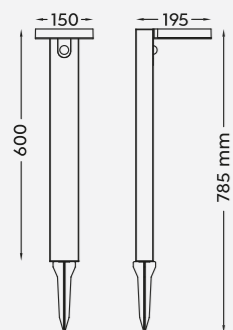
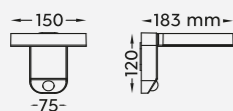

max.  
6-8m/90°



Ladezeit  
Charging time  
Temps de charge  
Oplaaftijd  
Tiempo de carga  
Tempo di carica  
Timp de incarcare  
Latausaika  
Czas ładowania



Leuchtdauer  
Luminous period  
Durée d'éclairage  
Brandtijd  
Tiempo de iluminación  
Tempo di durata  
Perioada de iluminare  
Valaistusaika  
Czas świecenia



# ESQUEL

Kunststoff  
 plastic  
 plastique  
 kunststof  
 plástico  
 plastica  
 plastic  
 muovi  
 plastik

42 Anthrazit · anthracite

Incl. 1 x SMD-LED, 4,5 W  
 290 lm, 3.000 K

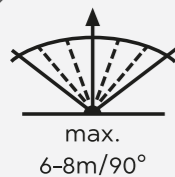
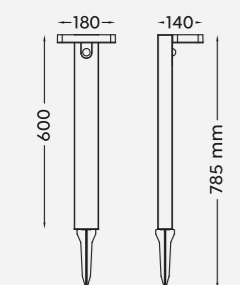
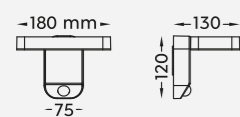

R22261142



R42261142

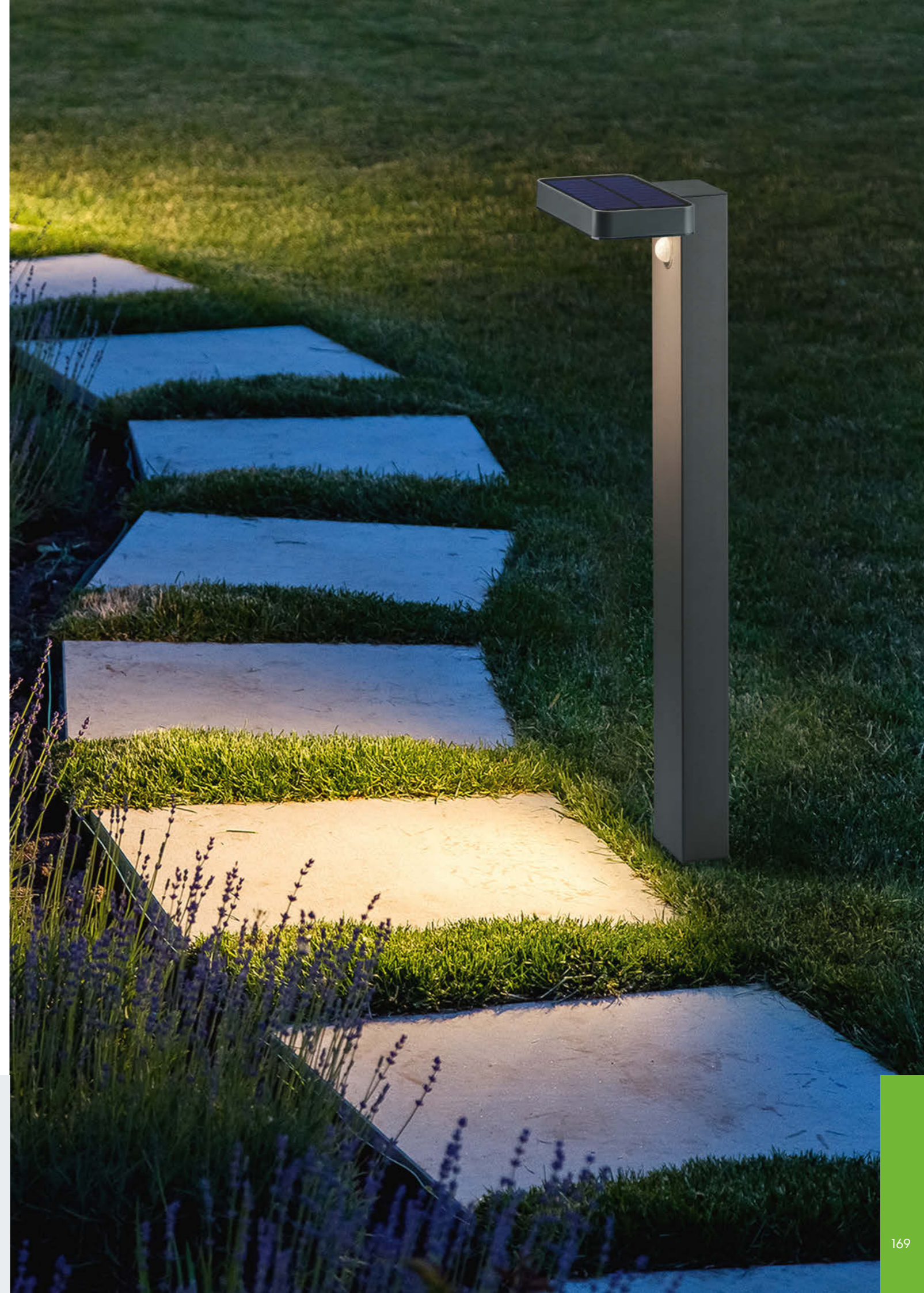

Ladezeit  
 Charging time  
 Temps de charge  
 Oplaaftijd  
 Tiempo de carga  
 Tempo di carica  
 Timp de incarcare  
 Latausaika  
 Czas ładowania



Leuchtdauer  
 Luminous period  
 Durée d'éclairage  
 Brandtijd  
 Tiempo de iluminación  
 Tempo di durata  
 Perioada de iluminare  
 Valaistusaika  
 Czas świecenia





Kunststoff  
plastic  
plastique  
kunststof  
plástico  
plastica  
plastic  
muovi  
plastik

**42** Anthrazit · anthracite

Incl. 1 x SMD-LED, 5 W  
200 lm, 3.000 K

**R22241142**



Incl. 1 x SMD-LED, 4,8 W  
340 lm, 3.000 K

**R22281142**

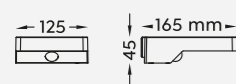

## MENDOZA

R22241142



## FOMOSA

R22281142

## SALTA

Metall, Acryl  
metal, acryl  
metale, acryl  
metaal, acryl  
metal, acrílico  
metallo, acrilico  
metal, acrilic  
metalli, akryyli  
metal, akryl

**07** Nickel matt · nickel mat

**42** Anthrazit · anthracite

Incl. 1 x SMD-LED, 3 W  
165 lm, 3.000 K

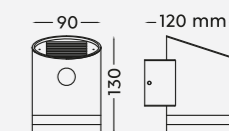

R22231107



R22231142

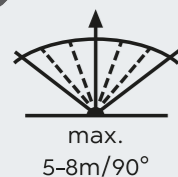

max.  
5-8m/90°



Ladezeit  
Charging time  
Temps de charge  
Oplaadtijd  
Tiempo de carga  
Tempo di carica  
Timp de incarcare  
Latausaika  
Czas ładowania



Leuchtdauer  
Luminous period  
Durée d'éclairage  
Brandtijd  
Tiempo de iluminación  
Tempo di durata  
Perioada de iluminaie  
Valaistusaika  
Czas świecenia

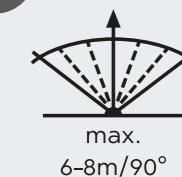

max.  
6-8m/90°



# SILVA

Kunststoff  
plastic  
plastique  
kunststof  
plástico  
plastica  
plastic  
muovi  
plastik

01 Weiß · white

Incl. 1 x SMD-LED, 0,1 W

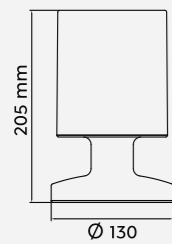

R54076101

# GARCIA

Kunststoff  
plastic  
plastique  
kunststof  
plástico  
plastica  
plastic  
muovi  
plastik

01 Weiß · white

Incl. 1 x RGBW-LED, 0,1 W

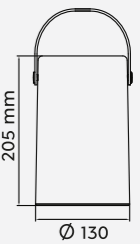

R54066101



Ladezeit  
Charging time  
Temps de charge  
Oplaadtijd  
Tiempo de carga  
Tempo di carica  
Timp de încarcare  
Latausaika  
Czas ładowania



Leuchtdauer  
Luminous period  
Durée d'éclairage  
Brandtijd  
Tiempo de iluminación  
Tempo di durata  
Perioada de iluminare  
Valaistusaika  
Czas świecenia



USB-C



USB-C Anschluss mit Ladefunktion  
Recharging USB-C connection  
Entrée USB-C de rechargement  
Opladende USB-C aansluiting  
Conexión USB-C de recarga  
Connessione USB-C di ricarica  
Conexiune USB-C reîncărcare  
Lataaminen USB-C-liitäntä  
ładowania USB-C połączenie



RGBW Farbwechsler  
RGBW Colorchanging  
Changement de couleur RGBW  
RGBW Kleurverandering  
Cambio de color RGBW  
Cambia colore RGBW  
Schimbator de culoare RGBW  
Värienvaihto RGB  
Zmieniający kolor RGBW





# MINEROS

Kunststoff  
plastic  
plastique  
kunststof  
plástico  
plastica  
plastic  
muovi  
plastik

11 Grau · grey

Incl. SMD-LED, 0,02 W

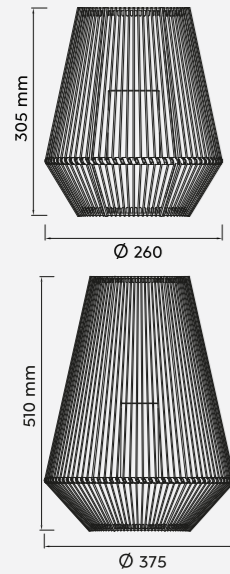

R55256911

R55256111

# SANTANA

Aluminium Druckguss, Kunststoff  
diecast aluminium, plastic  
fonte d'aluminium, plastique  
gegoten aluminium, kunststof  
aluminio fundido, plástico  
pressofusione di alluminio, plastica  
fonta aluminiu, plastic  
valualumiini, muovi  
barwione aluminium, plastik

32 Schwarz matt / Braun ·  
black mat / brown

Incl. 1 x SMS-LED, 0,1 W

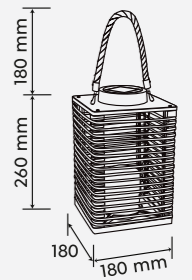

R55346132



Flammen-Effekt  
Flame effect  
Effet de flamme  
Vlammeneffect  
Efecto de llamas  
Effetto fiamma  
Efect de flacăra  
Liekkitehoste  
Efekt płomienia



Leuchtdauer  
Luminous period  
Durée d'éclairage  
Brandtijd  
Tiempo de iluminación  
Tempo di durata  
Perioada de iluminare  
Valaistusaika  
Czas świecenia



Leuchtdauer  
Luminous period  
Durée d'éclairage  
Brandtijd  
Tiempo de iluminación  
Tempo di durata  
Perioada de iluminare  
Valaistusaika  
Czas świecenia



Ladezeit  
Charging time  
Temps de charge  
Oplaaftijd  
Tiempo de carga  
Tempo di carica  
Timp de incarcare  
Latausaika  
Czas ładowania





# MAIRANA

Metall  
metal  
metale  
metaal  
metal  
metallo  
metal  
metalli  
metal

32 Schwarz matt · black mat

Incl. 1 x SMS-LED, 0,1 W

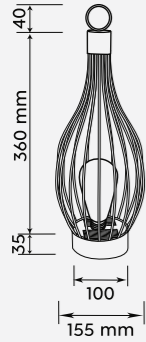

R55306132

# COTOCA

Metall  
metal  
metale  
metaal  
metal  
metallo  
metal  
metalli  
metal

32 Schwarz matt · black mat

Incl. SMD-LED, 0,01 W

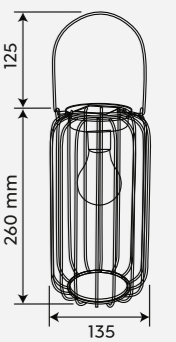

R55316132



Dämmerungssensor  
Dusk sensor  
Décteur de crépuscule  
Schemeringsensor  
Sensor de oscuridad  
Sensore crepuscolare  
Senzor de lumina/amurg  
Hämärätunnistin  
Czujnik zmierzchowy



Ladezeit  
Charging time  
Temps de charge  
Oplaadtijd  
Tiempo de carga  
Tempo di carica  
Timp de incarcare  
Latausaika  
Czas ładowania



Dämmerungssensor  
Dusk sensor  
Décteur de crépuscule  
Schemeringsensor  
Sensor de oscuridad  
Sensore crepuscolare  
Senzor de lumina/amurg  
Hämärätunnistin  
Czujnik zmierzchowy



Leuchtdauer  
Luminous period  
Durée d'éclairage  
Brandtijd  
Tiempo de iluminación  
Tempo di durata  
Perioada de iluminare  
Valaistusaika  
Czas świecenia



# SONORA

Metall  
metal  
metale  
metaal  
metal  
metallo  
metal  
metalli  
metal

32 Schwarz matt · black mat

Incl. 1 x SMD-LED, 0,02 W

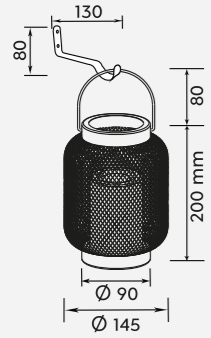

R54026132

# MERIDA

Metall  
metal  
metale  
metaal  
metal  
metallo  
metal  
metalli  
metal

32 Schwarz matt · black mat

Incl. 1 x SMD-LED, 0,08 W

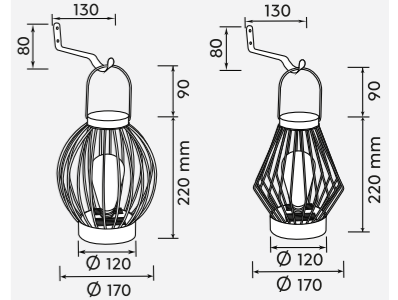

R54046132



R54036132



Ladezeit  
Charging time  
Temps de charge  
Oplaadtijd  
Tiempo de carga  
Tempo di carica  
Timp de incarcare  
Latausaika  
Czas ładowania



Leuchtdauer  
Luminous period  
Durée d'éclairage  
Brandtijd  
Tiempo de iluminación  
Tempo di durata  
Perioada de iluminare  
Valaistusaika  
Czas świecenia



Dämmerungssensor  
Dusk sensor  
Décteur de crépuscule  
Schemeringsensor  
Sensor de oscuridad  
Sensore crepuscolare  
Senzor de lumina/amurg  
Hämärätunnistin  
Czujnik zmierzchowy





Metall, Kunststoff  
 metal, plastic  
 metale, plastique  
 metaal, kunststof  
 metal, plástico  
 metallo, plastica  
 metal, plastic  
 metalli, muovi  
 metal, plastik

32 Schwarz matt · black mat

Incl. SMD-LED, 0,2 W

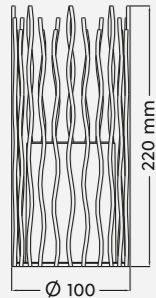

R55136132

Metall, Kunststoff  
 metal, plastic  
 metale, plastique  
 metaal, kunststof  
 metal, plástico  
 metallo, plastica  
 metal, plastic  
 metalli, muovi  
 metal, plastik

32 Schwarz matt · black mat

Incl. SMD-LED, 0,1 W

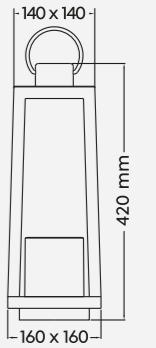

R55176132



Flammen-Effekt  
 Flame effect  
 Effet de flamme  
 Vlammeffect  
 Efecto de llamas  
 Effetto fiamma  
 Efect de flacăra  
 Liekkitehoste  
 Efekt płomienia



Ladezeit  
 Charging time  
 Temps de charge  
 Oplaadtijd  
 Tiempo de carga  
 Tempo di carica  
 Timp de incarcare  
 Latausaika  
 Czas ładowania



Leuchtdauer  
 Luminous period  
 Durée d'éclairage  
 Brandtijd  
 Tiempo de iluminación  
 Tempo di durata  
 Perioada de iluminare  
 Valaistus aika  
 Czas świecenia



Ladezeit  
 Charging time  
 Temps de charge  
 Oplaadtijd  
 Tiempo de carga  
 Tempo di carica  
 Timp de incarcare  
 Latausaika  
 Czas ładowania



Leuchtdauer  
 Luminous period  
 Durée d'éclairage  
 Brandtijd  
 Tiempo de iluminación  
 Tempo di durata  
 Perioada de iluminare  
 Valaistus aika  
 Czas świecenia



# MELO

Kunststoff  
plastic  
plastique  
kunststof  
plástico  
plastica  
plastic  
muovi  
plastik

01 Weiß · white

Incl. 1 x RGBW-LED, 0,5 W

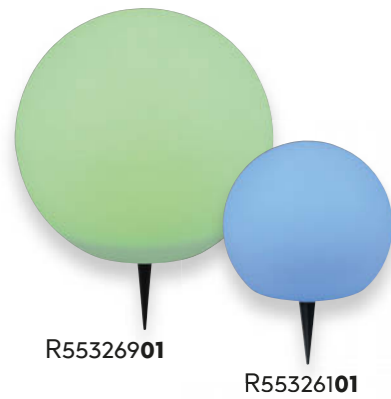
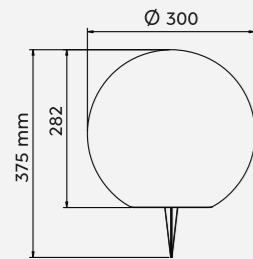
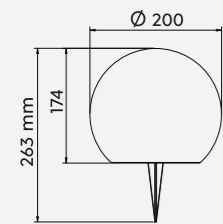

# CAMPUS

Metall, Kunststoff  
metal, plastic  
metale, plastique  
metaal, kunststof  
metal, plástico  
metallo, plastica  
metal, plastic  
metalli, muovi  
metal, plastik

32 Schwarz matt · black mat

Incl. 3 x SMD-LED, 0,1 W

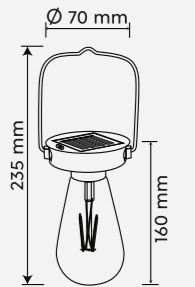

RGBW Farbwechsler  
RGBW Colorchanging  
Changement de couleur RGBW  
RGBW Kleurverandering  
Cambio de color RGBW  
Cambia colore RGBW  
Schimbator de culoare RGBW  
Värinvaihto RGB  
Zmieniający kolor RGBW



Ladezeit  
Charging time  
Temps de charge  
Oplaatijd  
Tiempo de carga  
Tempo di carica  
Timp de încarcare  
Latausaika  
Czas ładowania



Leuchtdauer  
Luminous period  
Durée d'éclairage  
Brandtijd  
Tiempo de iluminación  
Tempo di durata  
Perioada de iluminare  
Valaistusaika  
Czas świecenia



3er Set / Set 3



# Produkteigenschaften · Features

Caractéristiques · Kenmerken · Acabados ·  
Caratteristiche · Caracteristici · Ominaisuudet · Cechy



Schalter · Switch  
Interrupteur · Schakelaar · Interruptor ·  
Interruttore · Intrerupator · Kytkin ·  
Przełącznik



Fernbedienung · Remote control  
Commande à distance · Afstandsbediening ·  
Mando a distancia · Comando a distanza ·  
Telecomanda · Kauko-ohjain · Pilot



Integrierter Dimmer · Integrated dimmer  
Variateur intégré · Geïntegreerde dimmer ·  
Regulador integrado · Dimmer integrato ·  
Variator de lumina integrat · Integroitu himmennin ·  
Wbudowany ściemniacz



RGBW Farbwechsler · RGBW Colorchanging  
Changement de couleur RGBW ·  
RGBW Kleurverandering · Cambio de color RGBW ·  
Cambia colore RGBW · Schimbator de culoare  
RGBW · Värvinvaihto RGB · Zmieniający kolor RGBW



RGB Farbwechsler · RGB Colorchanging  
Changement de couleur RGB ·  
RGB Kleurverandering · Cambio de color RGB ·  
Cambia colore RGB · Schimbator de culoare RGB ·  
Värvinvaihto RGB · Zmieniający kolor RGB



Schwenkbar · Tiltable  
Pivotant · Draaibaar · Pivotante ·  
Girevole · Pivotant · Suunnattava · Skretny



Steckdose · Plug  
Prise · Stekker · Enchufe · Spina ·  
Priza · Katkaisin · Gniazdko



Bewegungssensor · Motion sensor  
Détecteur de mouvement · Bewegungssensor ·  
Sensor de movimiento · Sensore di movimento ·  
Sensor de mişcare · Liiketunnistin · Czujnik ruchu



Dämmerungssensor · Dusk sensor  
Détecteur de crépuscule · Schemeringsensor ·  
Sensor de oscuridad · Sensore crepuscolare ·  
Sensor de lumina/amurg · Hämärätunnistin ·  
Czujnik zmierzchowy



4 fach TOUCH · 4 level Touch function  
Interrupteur tactile 4 niveaux ·  
Touch schakelaar 4 niveaus · Función Táctil 4 nivel ·  
Interruttore touch 4 livelli · Intrerupator tactil  
4 nivele · Kosketuskäyttöinen 4 taso ·  
Funkcja dotykowa 4 poziomy



Up and down Beleuchtung ·  
Up and Down lighting  
Point lumineux en haut et en bas · Lichtpunt boven  
en onder · Luz de arriba y abajo · Luce su e giù ·  
Sus și în jos lumina · Ylös ja alas valoa ·  
W górę iw dół światło



Lichtfarbe stufenlos einstellbar ·  
Light color infinitely variable  
Couleur de lumière infiniment variable ·  
Lichtkleur traploos instelbaar · Color de luz  
infinitamente variable · Culoare lumină infinit  
variabilă · Valon väri portaattomasti ·  
Jasny kolor bezstopniowo



Ohne Leuchtmittel · Lamp(s) excluded  
Sans ampoule(s) · Zonder lichtbron(nen) ·  
Sin bombilla(s) · Lampadina Esclusa · Fara bec (s) ·  
Ilman polttimo (s) · Bez żarówki (s)



Timer · Timer  
Minuterie · Timer · Temporizador · Timer ·  
Temporizator · Ajastin · Timer



Helligkeit einstellbar · Adjustable light level  
Niveau d'éclairage ajustable · Instelbaar  
lichtniveau · Nivel de luz ajustable · Livello di luce  
regolabile · Nivelul de lumina reglabil · Säädettävä  
valo taso · Regulowana jasność światła



Bluetooth Lautsprecher ·  
Bluetooth loudspeaker  
Haut-parleur bluetooth · Bluetooth luidspreker ·  
Altavoz de bluetooth · Altoparlante bluetooth ·  
Difuzor Bluetooth · Bluetooth-kaiutin ·  
Głośnik Bluetooth



USB Anschluss · USB connection  
Entrée USB · USB aansluiting · Conexión USB ·  
Connessione USB · Conexiune USB ·  
USB-liitäntä · Połączenie USB



USB Anschluss mit Ladefunktion ·  
Recharging USB connection  
Entrée USB de rechargement · Opladende USB  
aansluiting · Conexión USB de recarga ·  
Connessione USB di ricarica · Conexiune USB  
reîncărcare · Lataaminen USB-liitäntä ·  
Ładowania USB połączenie



Memory Funktion · Memory function  
fonction mémoire · Geheugen functie ·  
Función de memoria · Funzione memorizzazione ·  
functia memorie · Muistitoiminto · Funkcja pamięci



Akkubetrieb · Rechargeable battery operated  
Fonctionnement sur batteries rechargeable ·  
Opladbare accu · Batería recargable ·  
Batteria Ricaricabile · Operabil prin baterie  
reincarabila · Ladattava akku ·  
Akumulator zasilany baterijnie



Batteriebetrieb · Battery operated  
Fonctionnement sur batterie · Werkt op batterijen ·  
Funcionamiento con batería · Funzionamento a  
batteria · Funcționare cu baterie · Käyttöaika ·  
Zasilana na baterie



Solar · Solar  
Solaire · Solair · Solar · Solare ·  
Solar · Aurinkokenno · Solar



Ladezeit · Charging time  
Temps de charge · Oplaadtijd · Tiempo de carga ·  
Tempo di carica · Timp de incarcare · Latausaika ·  
Czas ładowania



Leuchtdauer · Luminous period  
Durée d'éclairage · Brandtijd · Tiempo de  
iluminación · Tempo di durata · Perioada de  
iluminare · Valaistusaika · Czas świecenia



Flammen-Effekt · Flame effect  
Effet de flamme · Vlammeffect · Efecto de  
llamas · Effetto fiamma · Efect de flacăra ·  
Liekkitehoste · Efekt płomienia



Abstrahlwinkel · Emission angle  
Angle de rayonnement · Uitstraalhoek ·  
Ángulo de emisión · Angolo di emissione ·  
Unghiul de emisii · Säteilykulma · Kął emisji



Belastbarkeit · Resilience  
Limite de charge · Belastbaarheid · Resistencia ·  
Resistenza · Reziștența la solicitare ·  
Kuormittavuus · Nośność



Bewegungssensor und Orientierungslicht.  
Die Leuchte verfügt über ein Orientierungslicht, das sich bei Dämmerung oder Dunkelheit automatisch einschaltet.  
Wird eine Bewegung erfasst, schaltet die Leuchte von Orientierungslicht auf volle Lichtleistung

Motion sensor and orientation light ·  
The luminaire has an orientation light that switches on automatically at dusk or in the dark.  
If movement is detected, the luminaire switches from orientation light to full light output.

Captur de mouvement et lumière d'orientation.  
Le luminaire est muni d'une lumière d'orientation qui s'allume automatiquement dès qu'il fait sombre ou dans le noir.  
Si un mouvement est détecté, le luminaire passe de la lumière d'orientation à la lumière maximale.

Bewegungssensor en oriëntatielicht.  
Het verlichtingstoestel heeft een oriëntatielicht dat automatisch inschakelt bij schemerdonker of in het donker.  
Wanneer beweging waargenomen wordt, schakelt het verlichtingstoestel over van oriëntatielicht naar volledig lichtvermogen.

Lámpara con sensor de movimiento y de orientación.  
La lámpara dispone de una luz de orientación que se enciende automáticamente al anochecer o en la oscuridad.  
Si se detecta movimiento, la lámpara pasa de luz de orientación a plena potencia luminosa.

Sensore di movimento e luce di orientamento.  
La lampada è dotata di una luce di orientamento che si accende automaticamente al crepuscolo o al buio.  
Se viene rilevato un movimento, la lampada passa dalla luce di orientamento alla piena emissione di luce.

Senzor de mişcare și lumină de orientare.  
Corpul de iluminat are o lumină de orientare care se pornește automat în amurg sau în întuneric.  
Dacă este detectată mişcare, corpul de iluminat trece de la lumina de orientare la iluminat deplin.

Liiketunnistin ja suuntavalo.  
Valaisimessa on suuntavalo, joka syttyy automaattisesti illansarastuksessa tai pimeään laskiessa.  
Jos liikettä havaitaan, valaisin siirtyy suuntavalosta täyteen valaistustehoon.

Czujnik ruchu i światło orientacyjne.  
Oprawa posiada światło orientacyjne, które włącza się automatycznie o zmierzchu lub w ciemności.  
W przypadku wykrycia ruchu oprawa przełącza się ze światła orientacyjnego na pełną moc świetlną.



Lichtfarbe einstellbar · Adjustable light color  
Couleur de lumière réglable · Lichtkleur instelbaar ·  
Color de luz regulable · Colore della luce regolabile ·  
Lumina colorata reglabila · Värlämpötila säädettävissä ·  
Regulowana barwa światła



DIP SWITCH  
Lichtfarben direkt an der Leuchte einstellbar ·  
Colours directly adjustable at the lamp  
Les couleurs de la lumière peuvent être réglées  
directement sur le luminaire · Lichtkleuren direct  
instelbaar op de lamp · Tonalidades de luz  
ajustables directamente en la lámpara · Colori della  
luce regolabili direttamente sulla lampada · Colori  
ale luminii reglabile direct de la bec · Valon väri  
asetettävissä suoraan valaisimesta · Barwy światła  
można ustawić bezpośrednio na oprawie



Sensordimmer · Sensor dimmer  
Variateur tactile · Touchdimmer ·  
Regulador con sensor · Touchdimmer ·  
Variator cu senzor · Kosketushimmennin ·  
Czujnik ściemniania



USB-C Anschluss mit Ladefunktion ·  
Recharging USB\_c connection  
Entrée USB-C de rechargement · Opladende  
USB-C aansluiting · Conexión USB-C de recarga ·  
Connessione USB-C di ricarica · Conexiune USB-C  
reîncărcare · Lataaminen USB-C-liitäntä ·  
Ładowania USB-C połączenie



# Farben & Materialien · Colours and materials

Couleurs et matériaux · Kleuren en materialen · Colores y materiales · Colori e materiali ·  
 Culori si materiale · Värit ja materiaalit · Kolory i materiały

- 01 Weiß · white**  
 blanc · wit · blanco · bianco · alb · valkoinen · biały
- 02 Schwarz · black**  
 noir · zwart · negro · nero · negru · musta · czarny
- 07 Nickel matt · nickel mat**  
 nickel mat · nikkel mat · níquel mate · nichel opaco ·  
 nichel mat · harjattu teräs · nikiel mat
- 11 Grau · grey**  
 gris · grijs · gris · grigio · gri · harmaa ·  
 popielaty · gri
- 24 rostfarbig · rusty**  
 rouille · roestkleur · óxido · ruggine · ruginiu ·  
 rustiikki · miedz
- 30 holzfarbig · wood coloured**  
 couleur bois · houtkleur · color maderá · colore di legno ·  
 culoare lemn · puunvärinen · kolor drewna · ahşap renk
- 31 Weiß matt · white mat**  
 blanc mat · wit mat · estera blanca · bianco opaco ·  
 alb mat · valkoinen matto · biały mat

- 32 Schwarz matt · black mat**  
 noir mat · mat zwart · estera negra · nero opaco ·  
 negru mat · musta matto · czarny mat
- 42 Anthrazit · anthracite**  
 antracite · antraciet · antracita · antracite · antracit ·  
 antrasiitti · antracyt
- 49 Pistaziengrün · pistachio green**  
 vert pistache · pistachegroen · verde pistacho ·  
 verde pistacchio · verde fistic · pistaasin vihreä ·  
 zielony pistacjowy
- 77 Ultimate Grau · ultimate grey**  
 gris ultimate · ulziem grijs · gris absoluto ·  
 grigio assoluto · gri suprem · ultimaattinen harmaa ·  
 ciemnoszary
- 83 Illuminate Gelb · illuminate yellow**  
 jaune illuminate · helder geel · amarillo iluminado ·  
 giallo brillante · galben strălucitor · hehkuvan keltainen ·  
 swietlisty żółty
- 87 titanfarbig · titan**  
 titane · titaan · titán · titano · titaniu ·  
 titaani · tytanowy

Seite Page	Artikel-Nr. Product No.	EAN-Nummer EAN-Number	Seite Page	Artikel-Nr. Product No.	EAN-Nummer EAN-Number
123	201760124	4017807442021	96	220060242	4017807241525
123	201760142	4017807445411	26	220760142	4017807259063
106	201860130	4017807492859	65	220969142	4017807259315
108	201860142	4017807433210	36	221160142	4017807302004
108	201860242	4017807442410	34	221169142	4017807279290
124	201960124	4017807442045	53	221460142	4017807490473
124	201960142	4017807442052	53	221460242	4017807564037
118	202360124	4017807449891	98	221560142	4017807282375
119	202360142	4017807442069	30	221660242	4017807291544
125	202760124	4017807445589	30	221669242	4017807297614
125	202760142	4017807449884	28	221760142	4017807303551
114	204160124	4017807413939	29	221769142	4017807303568
113	204160131	4017807492408	32	222060142	4017807337624
112	204160142	4017807413946	90	222260124	4017807410594
115	204169124	4017807492446	92	222260142	4017807382570
115	204169131	4017807492422	90	222260224	4017807410587
115	204169142	4017807492460	92	222260242	4017807382587
48	204260224	4017807519006	24	222360142	4017807384321
48	204260231	4017807518986	85	222860142	4017807492590
48	204260242	4017807453171	76	222960131	4017807491234
49	204269224	4017807519044	76	222960142	4017807491258
49	204269231	4017807519020	77	222960231	4017807491319
48	204269242	4017807453195	76	222960242	4017807491326
50	206060142	4017807490480	74	222969131	4017807491296
101	207269124	4017807492613	74	222969142	4017807491272
100	207269131	4017807492620	74	222969231	4017807491357
100	207269142	4017807492637	75	222969242	4017807491371
102	207360142	4017807492675	94	224060142	4017807434330
104	209660130	4017807492798	94	224060242	4017807434347
120	210860124	4017807529500	40	225360142	4017807481501
120	210860142	4017807506129	39	225369142	4017807481525
121	210869124	4017807529678	22	226260142	4017807492545
121	210869142	4017807506143	44	226360142	4017807492347
116	211060131	4017807529456	42	226369142	4017807492354
116	211060142	4017807506174	57	226460231	4017807415605
116	211069131	4017807529463	57	226460242	4017807415612
116	211069142	4017807506198	59	226560242	4017807408539
88	211660132	4017807564075	68	226660242	4017807388893
110	212060142	4017807529272	68	226669242	4017807388817
111	212069142	4017807529289	60	226860231	4017807382822
79	212160242	4017807529340	60	226860242	4017807382839
61	212560224	4017807564051	58	226960231	4017807382259
61	212560231	4017807564068	58	226960242	4017807382266
61	212560232	4017807564044	84	227260142	4017807369236
46	214260142	4017807529210	69	227360142	4017807369229
46	214260242	4017807529234	56	227560231	4017807337570
46	214269142	4017807529227	56	227560242	4017807337594
46	214269242	4017807529241	56	227660231	4017807337600
96	220060142	4017807241501	56	227660242	4017807337617



Seite Page	Artikel-Nr. Product No.	EAN-Nummer EAN-Number	Seite Page	Artikel-Nr. Product No.	EAN-Nummer EAN-Number	Seite Page	Artikel-Nr. Product No.	EAN-Nummer EAN-Number	Seite Page	Artikel-Nr. Product No.	EAN-Nummer EAN-Number
80	227760142	4017807303537	98	421560142	4017807282399	16	540969142	4017807564013	148	R45101101	4017807500295
62	227860242	4017807298611	98	421560242	4017807282405	164	541069132	4017807564242	148	R45101901	4017807500301
82	228060101	4017807281552	30	421660242	4017807291551	20	570660142	4017807529173	155	R52176101	4017807496314
82	228060142	4017807281569	28	421760142	4017807303582	18	570669142	4017807529180	155	R52176102	4017807496338
70	228260101	4017807279528	32	422060142	4017807337648	66	577860142	4017807564105	155	R52176149	4017807541236
70	228260142	4017807279535	90	422260124	4017807410570	108	601860242	4017807442397	155	R52176177	4017807541274
79	228360142	4017807279610	92	422260142	4017807382600	64	620160142	4017807274905	155	R52176183	4017807541229
54	228460242	4017807284164	24	422360142	4017807384338	86	676960131	4017807453393	154	R52306131	4017807540925
63	228560242	4017807356984	94	424060142	4017807434361	86	676960142	4017807453416	154	R52306132	4017807540901
81	228669142	4017807356656	95	424067142	4017807445404	66	677860142	4017807529326	154	R52306149	4017807541014
64	228760142	4017807279276	40	425360142	4017807481563	128	800260142	4017807453133	154	R52306177	4017807541038
83	228960142	4017807259131	38	425369142	4017807481570	128	800260342	4017807453157	154	R52306183	4017807540956
72	229160142	4017807242126	22	426260142	4017807492576	126	821660107	4017807453287	178	R54026132	4017807564198
55	229360242	4017807242164	44	426360142	4017807492385	127	821660207	4017807453348	179	R54036132	4017807564204
55	229360287	4017807242171	42	426369142	4017807492392	126	821669107	4017807453300	179	R54046132	4017807564211
52	240660142	4017807563979	16	440969142	4017807564020	127	821669207	4017807453379	173	R54066101	4017807564266
73	240760142	4017807563986	164	441069132	4017807564259	129	821860142	4017807564143	172	R54076101	4017807564273
16	240960142	4017807563993	20	470660142	4017807529197	132	9960-07	4017807259360	152	R54086131	4017807564280
16	240969142	4017807564006	18	470669142	4017807529203	130	9961-11	4017807305777	152	R54086132	4017807564297
164	241069132	4017807564235	66	477860142	4017807564112	130	9962-11	4017807305784	152	R54086177	4017807564303
20	270660142	4017807529111	106	501860130	4017807492873	130	9964-42	4017807445299	152	R54086183	4017807564310
20	270660242	4017807529159	108	501860142	4017807433234	133	9965-32	4017807472349	153	R54096131	4017807564327
18	270669142	4017807529135	118	502360124	4017807453072	135	R20026242	4017807529395	153	R54096132	4017807564334
18	270669242	4017807529166	118	502360142	4017807453096	135	R20026942	4017807529418	150	R54126131	4017807570571
71	273360142	4017807492750	114	504160124	4017807413977	145	R21186131	4017807564136	150	R54126142	4017807570595
66	277860142	4017807529333	112	504160142	4017807413991	145	R21186132	4017807564129	157	R55086101	4017807444421
122	301760124	4017807447309	48	504260142	4017807453218	138	R22052142	4017807490428	148	R55101101	4017807500271
122	301760142	4017807447323	50	506060142	4017807490497	138	R22062142	4017807490435	180	R55136132	4017807452778
106	401860130	4017807492897	102	507360142	4017807492705	142	R22151131	4017807453492	181	R55176132	4017807452853
108	401860142	4017807433258	104	509660130	4017807492804	142	R22151142	4017807453546	174	R55256111	4017807492064
118	402360124	4017807453102	88	511660132	4017807564082	171	R22231107	4017807458220	174	R55256911	4017807492095
118	402360142	4017807453119	110	512060142	4017807529296	171	R22231142	4017807452648	176	R55306132	4017807529401
114	404160124	4017807413953	46	514260142	4017807529258	170	R22241142	4017807452662	177	R55316132	4017807492262
112	404160142	4017807413960	96	520060142	4017807241563	166	R22251142	4017807452686	182	R55326101	4017807492101
48	404260142	4017807453232	26	520760142	4017807259100	168	R22261142	4017807452723	182	R55326901	4017807492125
50	406060142	4017807490503	36	521160142	4017807351590	170	R22281142	4017807452754	175	R55346132	4017807529425
102	407360142	4017807492729	34	521169142	4017807279313	140	R24236142	4017807564150	160	R57042001	4017807282801
104	409660130	4017807492828	30	521660242	4017807291568	141	R24246132	4017807564167	160	R57043001	4017807282818
120	410860124	4017807529548	28	521760142	4017807303575	139	R24256232	4017807564174	160	R57044001	4017807282825
120	410860142	4017807506167	32	522060142	4017807337631	139	R24266232	4017807564181	158	R57051101	4017807382518
116	411060142	4017807506211	90	522260124	4017807410563	134	R27026132	4017807529357	159	R57071101	4017807325348
117	411060342	4017807506228	92	522260142	4017807382594	134	R27036132	4017807529364	156	R57080101	4017807407556
88	411660132	4017807564099	24	522360142	4017807384345	136	R28222631	4017807408324	144	R60501031	4017807405873
110	412060142	4017807529302	94	524060142	4017807434354	136	R28222632	4017807411775	144	R60501042	4017807405910
46	414260142	4017807529265	40	525360142	4017807481549	137	R28232631	4017807408317	144	R60502031	4017807405927
96	420060142	4017807241792	38	525369142	4017807481556	137	R28232632	4017807411768	144	R60502042	4017807405934
26	420760142	4017807259087	22	526260142	4017807492569	183	R35146132	4017807529432	142	R62151131	4017807405941
36	421160142	4017807351583	44	526360142	4017807492361	166	R42251142	4017807452709	142	R62151142	4017807405989
34	421169142	4017807279306	42	526369142	4017807492378	168	R42261142	4017807452730			





**TRIO Leuchten GmbH**

Gut Nierhof 17  
D-59757 Arnsberg  
T +49 (0) 2931 9666-0  
F +49 (0) 2931 9666-57  
info@trio-leuchten.de  
www.trio-leuchten.de

**Reality Leuchten GmbH**

Gut Nierhof 17  
D-59757 Arnsberg  
T +49 2931 9666-99  
F +49 2931 9666-98  
info@reality-leuchten.de  
www.reality-leuchten.de

**TRIO International GmbH**

Gut Nierhof 17  
D-59757 Arnsberg  
T +49 (0) 2931 9666-587  
F +49 (0) 2931 9666-56  
info@trio-lighting.com  
www.trio-lighting.com

**BADEN WÜRTTEMBERG,  
RHEINLAND-PFALZ UND SAARLAND**

**Antonio De Simone**  
T +49 (0) 151 5855222  
antonio.desimone@trio-leuchten.de

**ÖSTERREICH**

**Wolfgang Melich**  
T +43 (0) 6605161228  
wolfgang.melich@trio-leuchten.de

**FRANCE**

**Stéphane Papierny**  
Directeur Commercial France  
info.france@trio-lighting.com

**Elsa Seron**

info.france@trio-lighting.com  
*Agent exclusif pour les départements  
27, 28 et 76*

**ESPAÑA**

**TRIO Lighting Ibérica SL**  
C/ Can Lietget nº9 nave 9  
Pol. Ind. Can Roqueta  
08206 Sabadell  
T +34 (0) 9 35 45 86 30  
F +34 (0) 9 33 96 45 48  
info.iberica@trio-lighting.com

**BAYERN, HESSEN**

**Martin Kluge**  
T +49 (0) 171 7300330  
martin.kluge@trio-leuchten.de

**SCHWEIZ**

**TRIO Leuchten**  
T +49 (0) 2931 9666-0  
info@trio-leuchten.de

**Sullivan Nicolas**

info.france@trio-lighting.com  
*Agent exclusif pour les départements  
01, 03, 07, 21, 26, 38, 39, 42,  
43, 48, 63, 69, 71, 73 et 74*

**Jean Philippe Bailly**

info.france@trio-lighting.com  
*Agent exclusif pour les départements  
60, 75 Nord, 92, 93 et 95*

**GREAT BRITAIN**

**TRIO Lighting UK Ltd.**  
Unit 5, Hemmells Park Hemmells, Laindon  
Essex  
SS1s 6GF  
T +44 (0) 12 68 88 95 95  
F +44 (0) 12 68 88 95 96  
sales@trio-lightinguk.com

**BERLIN, BRANDENBURG,  
MECKLENBURG-VORPOMMERN,  
SACHSEN, SACHSEN ANHALT, THÜRINGEN**

**Jörg Bumke**  
T +49 (0) 160 7406860  
joerg.bumke@trio-leuchten.de

**Vincent Zaepffel**

info.france@trio-lighting.com  
*Commercial pour les départements  
02, 08, 10, 25, 51, 52, 54, 55, 57, 59, 62,  
67, 68, 70, 80, 88 et 90*

**Jean Marc Beneforti**

info.france@trio-lighting.com  
*Agent exclusif pour les départements  
2a et 2b*

**DANMARK**

**Jan Rantzau-Bartens**  
info.denmark@trio-lighting.com

**SUOMI**

**TRIO Lighting Scandinavia Oy**  
Malmin raitti, rappu 17 B  
00700 Helsinki  
T +358 (0) 10 23 13 390  
F +358 (0) 10 23 13 399  
info.scandinavia@trio-lighting.com

Our Scandinavian organisation represents TRIO  
also in Sweden, Norway, Estonia, Latvia  
and Lithuania

**NEDERLAND**

**Karl Stok / Bas Martin**  
info.nederland@trio-lighting.com

**BREMEN, HAMBURG,  
NIEDERSACHSEN, SCHLESWIG-HOLSTEIN**

**Jens Gebers**  
T +49 (0) 170 1615227  
jens.gebers@trio-leuchten.de

**BELGIUM/BELGIQUE**

**Yves van den Berghe**  
info.belgium@trio-lighting.com

**NORDRHEIN-WESTFALEN**

**Christian Teller**  
T +49 (0) 171 4521820  
christian.teller@trio-leuchten.de

**Christophe Meulien**

info.france@trio-lighting.com  
*Agent exclusif pour les départements  
04, 05, 06, 11, 13, 30, 34, 66, 83 et 84*

**Jean Barel**

info.france@trio-lighting.com  
*Agent exclusif pour les départements  
09, 12, 15, 16, 19, 23, 24, 31, 32, 33, 40,  
46, 47, 64, 65, 81, 82 et 87*

**Michel Salamand**

info.france@trio-lighting.com  
*Agent exclusif pour les départements  
14, 17, 22, 29, 35, 36, 37, 41, 44, 49, 50,  
53, 56, 61, 72, 79, 85 et 86*

**Stéphane Riebel**

info.france@trio-lighting.com  
*Agent exclusif pour les départements  
18, 45, 58, 75 Sud, 77, 78, 89, 91 et 94*

**ITALIA**

**TRIO Lighting Italia s.r.l**  
Via Dosso Faiti, 3  
22066 Mariano Comense (CO)  
T +39 (0) 317 477 55  
F +39 (0) 313 551 560  
info.italia@trio-lighting.com

**ROMANIA**

**Gina Ionita**  
info.romania@trio-lighting.com