

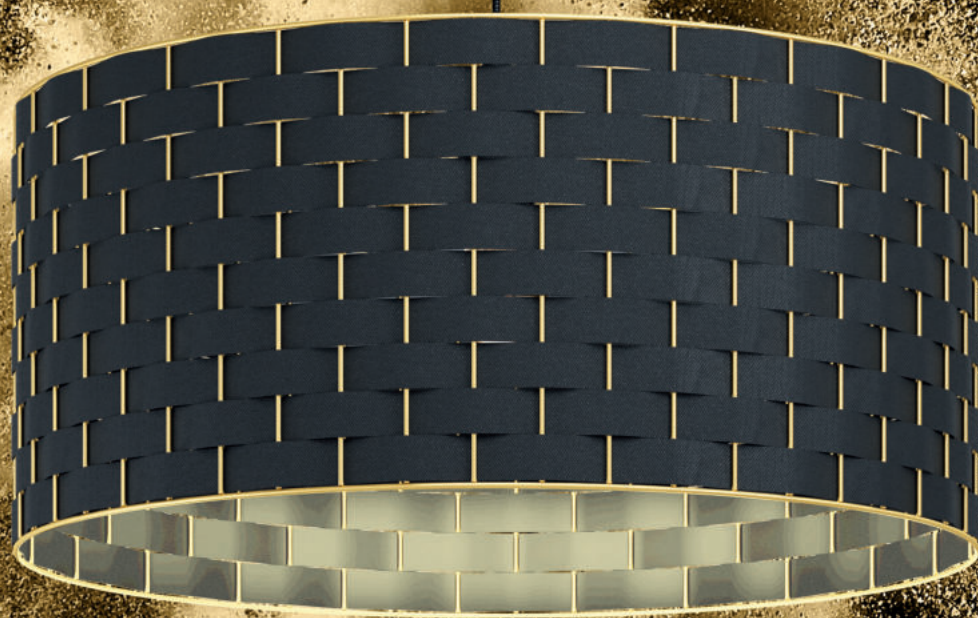

EGLO
my light | my style



2021/22

INTERIOR LIGHTING

WOHNRAUMLEUCHTEN
LUMINAIRES INTÉRIEURS



Dear customers and business partners,
loyal EGLO friends,

For the past year, the world has held its breath. It is a year that everyone will remember as one of distance and sacrifice, but also of opportunity and transformation.

Digitalisation in particular has undergone enormous growth recently, and we have met this challenge in various ways. During the last year we introduced our new online catalogue, which offers valuable additional information and features, and provides a more in-depth view of our range of products. We want to continue providing these additional benefits in future and include our entire living room lighting range in this popular digital format. In the 2021/22 season you can look forward as ever to some real lighting highlights, featuring a natural, minimalist, elegant design that is right on-trend, with warm, earthy tones and elements of wood and brass that will fit well in any home. Because of this natural design and the increased importance we as a society are placing on our connection with nature, we wanted to engage more intensively with the theme of sustainability and recognise our responsibility toward the environment. One of the ways we have achieved this is through compliance with FSC® standards, which promote responsible global forest management.

I hope you enjoy browsing our new catalogue.



Mag. René Tiefenbacher
CEO EGLO Group

Geschätzte Kunden und Geschäftspartner,
treue EGLO Freunde,

das vergangene Jahr hat die Welt in Atem gehalten und wird in den Köpfen aller bleiben, als ein Jahr der Distanz und des Verzichts, aber auch als ein Jahr der Chancen und des Wandels. Gerade der Bereich der Digitalisierung hat in kurzer Zeit ein enormes Wachstum erlebt und auch wir haben uns dieser Herausforderung auf verschiedenen Arten gestellt. Im letzten Jahr haben wir Ihnen bereits erstmals unseren neuen Online-Hauptkatalog vorgestellt, der Dank seiner zusätzlichen Informationen und Features einen deutlichen Mehrwert bietet und detailliertere Einblicke in unser Sortiment verspricht. Diesen zusätzlichen Vorteil möchten wir Ihnen auch in Zukunft bieten und unser gesamtes Wohnraumleuchten-Sortiment in diesem beliebten Digitalformat anbieten. In der Saison 2021/22 erwarten Sie wie gewohnt wahre Trend- und Leuchten-Highlights, die aktuell von Natürlichkeit, Minimalismus, aber auch von Eleganz geprägt sind und mit ihren warmen Erdtönen, sowie Holz- und Messing-Elementen einen Platz in jedem Zuhause finden. Gerade in Bezug auf die Natürlichkeit und die für uns Menschen deutlich an Bedeutung gewonnene Verbundenheit zur Natur hat uns dazu veranlasst, uns noch stärker mit dem Thema Nachhaltigkeit auseinanderzusetzen und unserer Verantwortung gegenüber der Umwelt Rechnung zu tragen. Dies ist uns unter anderem mit der Einhaltung der FSC® Standards gelungen, die eine verantwortungsvolle weltweite Waldbewirtschaftung fördern.

Ich wünsche Ihnen viel Freude beim
Durchschauen des neuen Hauptkatalogs.

Très chers clients et partenaires,
fidèles amis d'EGLO,

L'année 2020 a tenu le monde en haleine et restera gravée dans tous les esprits comme une année de distanciation et de sacrifices, mais aussi comme une année d'opportunités et de changement. Le secteur du numérique, par exemple, a connu une croissance fulgurante en peu de temps, et nous avons relevé les défis qui en découlent de diverses manières. L'an dernier, nous vous avons présenté la première version électronique de notre nouveau catalogue. Grâce aux informations et fonctionnalités supplémentaires qu'il contient, il offre une plus grande valeur ajoutée ainsi qu'un aperçu plus détaillé de notre gamme de produits. À l'avenir, nous souhaitons continuer à vous offrir cet avantage et proposer toute notre gamme d'éclairage pour la maison au format numérique. Pour la saison 2021/22, vous pouvez vous attendre, comme d'habitude, à des nouveautés en matière de tendances et d'éclairage. Les mots d'ordre sont nature, minimalisme, mais aussi élégance. Avec leurs éléments en bois et en laiton, ainsi que leurs tons chauds, nos produits trouveront leur place dans chaque intérieur. Le caractère naturel et le lien avec la nature, qui a clairement gagné en importance pour nous tous, nous ont incités à nous pencher encore plus sur le thème de la durabilité et à assumer notre responsabilité envers l'environnement. L'un des moyens d'y parvenir est de se conformer aux normes FSC®, qui promeuvent une gestion responsable des forêts à travers le monde.

Je vous souhaite beaucoup de plaisir à parcourir le
nouveau catalogue.

CONTENTS

INHALT
CONTENU



EGLO CONNECT

P.010 - 077



LIGHTING FAMILIES
FABRIC & WOOD LUMINAIRES
STOFF- UND HOLZLEUCHTEN
LUMINAIRES À TEXTIL ET BOIS

P.100 - 191



EGLO ACCESS

P.078 - 099



LIGHTING FAMILIES
STANDARD LUMINAIRES
STANDARD LEUCHTEN
LUMINAIRES STANDARD

P.192 - 301



LIGHTING FAMILIES
GLASS CHANDELIERS
LEUCHTENFAMILIEN
FAMILLES DE LUMINAIRES

P.302 - 311



HANGING & PENDANT LUMINAIRES

HÄNGE- & PENDELLEUCHTEN
LUMINAIRES SUSPENSIONS

P.312 - 409



WALL & CEILING LUMINAIRES

WAND- & DECKENLEUCHTEN
APPLIQUES & PLAFONNIERS

P.410 - 553



TABLE & FLOOR LUMINAIRES

TISCH- & STEHLEUCHTEN
LUMINAIRES DE TABLE & LAMPADAIRES

P.712 - 749



BATH & MIRROR LUMINAIRES

BAD- & SPIEGELLEUCHTEN
LUMINAIRES DE BAIN & MIROIR

P.554 - 615



OFFICE TABLE LUMINAIRES

OFFICE TISCHLEUCHTEN
LAMPES DE TABLE DE BUREAU

P.750 - 779



SPOTS & TRACK LUMINAIRES

SPOTS- & SCHIENENLEUCHTEN
SPOTS & LUMINAIRES SUR RAIL

P.616 - 703



CHILDREN LUMINAIRES

KINDERLEUCHTEN
LUMINAIRES POUR ENFANTS

P.780 - 785



CLIP & PLUG LUMINAIRES

KLEMM- & STECKERLEUCHTEN
LUMINAIRES À PINCE & SUR PRISE

P.704 - 711



KITCHEN & FUNCTION LUMINAIRES

KÜCHEN- & FUNKTIONSLEUCHTEN
LUMINAIRES FONCTIONNELS & DE CUISINE

P.786 - 791



ACCESSORIES

ZUBEHÖR
ACCESSOIRES

P.792 - 795



INDEX & LEGEND

INDEX & ERKLÄRUNG
INDEX & LÉGENDE

P.796 - 824



EGLO TREND HIGHLIGHTS

2021/22

The EGLO design team has once again drawn on current mega-trends as a source of inspiration for the 2021/22 season. The new EGLO products' use of shape and colour, choice of materials, and overall aesthetic harmonise perfectly with both contemporary and future living trends. Minimalism and the increasingly popular use of materials and colours such as brass and earth tones have had a particularly strong influence on this season's luminaire designs.

Auf Basis der Megatrends hat sich das Design-Team von EGLO auch für die Saison 2021/22 inspirieren lassen. Mit ihrer Formsprache, Farbgebung sowie den verwendeten Materialien fügen sich die EGLO Neuheiten in die aktuellen wie auch zukünftigen Wohntrends ein. Der Trend des Minimalismus sowie die Verwendung von Materialien und Farben wie Messing und Erdtöne haben auf die aktuellen Leuchten-Designs besonderen Einfluss genommen.

Sur la base des mégatendances, l'équipe de conception EGLO a également été inspirée pour la saison 2021/22. Avec leur langage visuel, leur palette de couleurs et les matériaux utilisés, les innovations EGLO s'intègrent dans les tendances de la vie d'aujourd'hui et de demain. La tendance au minimalisme et l'utilisation de matériaux et de couleurs tels que le laiton et les tons de terre ont eu une influence particulière sur les conceptions actuelles de nos luminaires.

MINIMALISM - The art of less, the conscious reduction of shapes and colours to the bare essentials, is reflected in our luminaires. Clear and simple shapes and plain colours combine to create a calm atmosphere, in keeping with the maxim "less is more". Warm grey tones and timber elements give the room a welcoming touch, adding atmospheric highlights and offering a harmonious stage for your entire living space to work its magic without any distractions.

MINIMALISMUS - Der bewusste Verzicht und die Kunst, Form und Farbe auf ein Minimum zu reduzieren, spiegelt sich in unseren Leuchten wider. Frei nach dem Prinzip „Weniger ist mehr“ sorgen klare und einfache Formen sowie schlichte Farben für eine ruhige Atmosphäre. Für die nötige Gemütlichkeit setzen warme Grautöne oder Holzelemente stimmungsvolle Akzente und bieten eine harmonische Bühne, um den gesamten Raum ganz ohne Ablenkung für sich wirken zu lassen.

LE MINIMALISME - Nos lampes reflètent un renoncement volontaire et l'art de réduire au minimum formes et couleurs. Selon le principe « faire plus avec moins », des formes claires et simples et des couleurs unies créent une atmosphère paisible. Pour le confort, des tons gris chauds ou des éléments en bois mettent en place une ambiance agréable et un décor harmonieux pour vous permettre de travailler dans une pièce sans aucune distraction.



ABREOSA



LAGUNITAS

Brass - Brass so popular back in the 50s and 60s, is currently enjoying a new wave of popularity. Skilfully paired with contrasting materials, the gleaming metallic hues of brass bring a touch of luxury to living spaces without appearing old-fashioned. We have incorporated the high-quality material into our new luminaire models and combined it with diverse other materials to create captivating modern designs that can be integrated into a variety of interiors, from urban to classical to minimalist.

Messing - Der bereits in den 50er und 60er Jahren so populäre Messingtrend erfreut sich aktuell an neuer Beliebtheit. Gekonnt kombiniert und kontrastreich in Szene gesetzt, bringt Messing mit seinem strahlenden Metallton einen Hauch von Luxus in die Wohnräume, ohne altmodisch zu wirken. Das hochwertige Material haben wir in unsere neuen Leuchten-Modelle einfließen lassen und in Kombination mit verschiedenen Materialien charmante und moderne Designs geschaffen, die sich in unterschiedliche Einrichtungen von urban über klassisch bis hin zu minimalistisch integrieren lassen.

Le laiton - La tendance du laiton, déjà si populaire dans les années 50 et 60, est actuellement à nouveau au goût du jour. Habilement combiné et mis en scène avec de riches contrastes, le laiton avec sa teinte métallique brillante apporte une touche de luxe aux espaces de vie sans paraître démodé. Nous avons incorporé ce matériau de haute qualité dans nos nouveaux modèles de luminaires et, en combinaison avec divers matériaux, avons créé des designs charmants et modernes qui peuvent être intégrés à des aménagements différents, qu'ils soient notamment urbains, classiques ou encore minimalistes.

Warm earth tones - The very popular back-to-nature trend has also brought about a significant shift in the field of design. More and more people have been embracing a return to nature in recent years and the associated use of natural materials has also left its mark on the world of colour, heralding the rise of brown as the new black. The colour brown in all its many facets can be beautifully paired with almost any other colour and, thanks to its diverse earthy tones, not only lends our living spaces a touch of naturalness, but also conveys a sense of warmth and comfort. Combining this year's popular colour trend with wood and brass elements helps accentuate its distinctive appeal.

Warme Erdtöne - Der starke Trend hin zu mehr Natürlichkeit hat auch im Design einen bedeutsamen Wandel bewirkt. Die in den letzten Jahren deutlich an Bedeutung gewonnene Verbundenheit zur Natur und die damit einhergehende Verwendung von natürlichen Materialien hat auch die Farbwelt geprägt und lässt Braun als das neue Schwarz triumphieren. Braun in all seinen Facetten lässt sich hervorragend kombinieren und verleiht unseren Wohnräumen durch seine vielfältigen Erdtöne nicht nur einen Hauch von Natürlichkeit, sondern vermittelt Gemütlichkeit und Behaglichkeit gleichermaßen. Die Kombination mit Holz oder Messing verleiht der neuen Trendfarbe ihre besonderen Akzente.

Des tons chauds de terre - La forte tendance vers un caractère plus naturel a également entraîné un changement significatif dans notre conception. Le lien avec la nature, qui a grandement gagné en importance ces dernières années, et l'utilisation associée de matériaux naturels ont également façonné l'univers des couleurs : c'est ainsi que le brun a détrôné le noir. Le brun sous toutes ses facettes peut être parfaitement combiné et, avec ses divers tons de terre, non seulement donner à nos salons une touche naturelle, mais aussi procurer confort et bien-être dans le même temps. La combinaison de cette nouvelle couleur tendance avec le bois ou le laiton lui confère ses accents si particuliers.



LOSALOMAS

Look out for this Logo!

Achten Sie auf das Logo!

Soyez attentif au logo !

What is a forest?

A peaceful oasis, the green lungs of the world, and an adventure playground for children of all ages!

The Forest Stewardship Council® (FSC®) is a global, not-for-profit organisation dedicated to the promotion of responsible forest management worldwide. The FSC® defines standards for responsible forest management in accordance with established principles that are developed and supported by stakeholders from the environmental, social and economic spheres. For more information, please see www.fsc.org.

Was ist Wald für uns?

Eine Oase der Ruhe, die Lunge der Welt oder ein Abenteuerspielplatz für große und kleine Kinder!

Das Forest Stewardship Council® (FSC®) ist eine globale, gemeinnützige Organisation, mit dem Zweck verantwortungsvolle Waldbewirtschaftung weltweit zu fördern. FSC® definiert Standards für eine verantwortungsvolle Waldbewirtschaftung nach festgelegten Prinzipien, die von Interessenvertretern aus den Bereichen Umwelt, Soziales und Wirtschaft entwickelt und getragen werden. Für weitere Informationen besuchen Sie www.fsc.org.

Que représente la forêt pour nous ?

Une oasis de calme, les poumons du monde ou un terrain de jeu d'aventure pour les enfants de tous âges !

Le Forest Stewardship Council® (FSC®) est une organisation internationale à but non lucratif dont le but est de promouvoir une gestion forestière responsable dans le monde entier. Le FSC® définit des normes de gestion forestière responsable selon des principes établis qui sont développés et soutenus par les parties prenantes des secteurs environnemental, social et économique. Pour plus d'informations, veuillez consulter www.fsc.org.

Look out for FSC® -certified products!
Achten Sie auf FSC® -zertifizierte Produkte!
Soyez attentif aux produits certifiés FSC® !



The mark of
responsible forestry

DIGITAL CATALOGUE

This year, we are also making the main catalogue in front of you available online, including lots of extra information and additional features. In addition to search and filter functions, the online catalogue includes extensive product photos, videos and additional information, complementing the paper edition wonderfully. Take a look at

<https://catalogue.eglo.com>

In diesem Jahr präsentieren wir den vor Ihnen liegenden Hauptkatalog wieder als Online-Katalog mit vielen Zusatzinformationen und zusätzlichen Features. Neben Such- und Filterfunktionen bietet der Online-Katalog mit reichhaltigen Produktabbildungen, Videos und zusätzlichen Informationen einen erheblichen Mehrwert zur gebundenen Ausgabe. Klicken Sie sich rein unter <https://catalogue.eglo.com>

Cette année, nous présentons à nouveau une version en ligne du catalogue général. Cette version contient de nombreuses informations et fonctionnalités complémentaires. Outre les fonctionnalités de recherche et de filtrage, le catalogue en ligne propose de nombreuses illustrations de produits, des vidéos et des informations complémentaires : une valeur ajoutée considérable par rapport à la version papier. Cliquez ici pour le découvrir : <https://catalogue.eglo.com>



99795



NEW/ NEU/ NOUVEAU



connect.2

 **zigbee**  **Bluetooth®**

Discover the smart world



OVERVIEW

EGLO CONNECT Z

 CONNECT-Z SENSOR p. 21	 CONNECT Z p. 21	 REMOTE 2.0 p. 21	 VALDELAGRANO-Z p. 22	 SIMOLARIS-Z p. 22-23	 MARGHERA-Z p. 24-25	 CAMINALES-Z p. 26	 SALICETO-Z p. 27
 LOMALTAS-Z p. 28	 TABIANO-Z p. 29	 JUAREZA-Z p. 29	 FRAIOLI-Z p. 30-31	 TOTARI-Z p. 32-33	 LANCIANO-Z p. 34	 CAPASSO-Z p. 35	 SILERAS-Z p. 35
 SAVATARILA-Z p. 36-37	 TURCONA-Z p. 38,42-43	 HERRORA-Z p. 40	 SALOBRENA-Z p. 44-47	 FUEVA-Z p. 48-59	 ROVITO-Z p. 60-63	 LED STRIPE-Z p. 64-65	 LM_LED_E27 p. 66
 LM_LED_E27 p. 66	 LM_LED_E14 p. 66	 LM_LED_GU10 p. 67	 LM_LED_E27 p. 68	 LM_LED_E27 p. 68	 LM_LED_E27 p. 68	 LM_LED_E27 p. 69	 LM_LED_E27 p. 69
 LM_LED_E27 p. 69	 LM_LED_E27 p. 70	 LM_LED_E27 p. 70	 LM_LED_E27 p. 70	 LM_LED_E27 p. 71	 LM_LED_E27 p. 71	 LM_LED_E27 p. 71	 LM_LED_E27 p. 72
 LM_LED_E27 p. 72	 LM_LED_E27 p. 72	 LM_LED_E27 p. 73	 LM_LED_E27 p. 73	 LM_LED_E27 p. 74	 LM_LED_E27 p. 74	 LM_LED_E27 p. 74	 LM_LED_E27 p. 75
 LM_LED_E27 p. 75	 LM_LED_E27 p. 76	 LM_LED_E27 p. 76	 LM_LED_E27 p. 76	 LM_LED_E27 p. 77			



This product is available in different colors and shapes./ Dieser Artikel ist in unterschiedlichen Farben und Formen verfügbar.
Cet article est disponible en différentes couleurs et formes.



connect.z combines two control technologies in one system

connect.z vereint zwei Steuerungstechnologien in einem System

connect.z réunit deux technologies de commande au sein d'un même système



ZigBee is far and away the most widely used standard in the smart home world.

ZigBee ist der am weitesten verbreitete Standard in der Smart Home Welt.

ZigBee est le protocole le plus répandu au monde dans le domaine du Smart Home.

ADVANTAGES :

- › Mesh network
- › Direct connection with Amazon Echo and Google Home
- › Compatible with products from different manufacturers
- › High level of security
- › Easy setup
- › Energy efficient

VORTEILE:

- › Mesh-Netzwerk
- › Direkte Verbindung mit Amazon Echo und Google Home
- › Herstellerübergreifend kompatibel
- › Hohe Sicherheit
- › Einfache Einrichtung
- › Energieeffizient

AVANTAGES:

- › Réseau maillé
- › Connexion directe à Amazon Echo et Google Home
- › Compatible indépendamment du fabricant
- › Sécurité élevée
- › Installation facile
- › Économe en énergie

connect.2



Bluetooth is an established standard in the digital world.

Bluetooth ist ein etablierter Standard in der digitalen Welt.

Bluetooth est un standard de communication reconnu dans le monde numérique.

ADVANTAGES:

- › Local & secure network
- › Protocol is mainly audio (low debit)
- › Mesh network: Elements are receivers and senders
- › Easy setup
- › Usable offline
- › Energy efficient

VORTEILE:

- › Lokales & sicheres Netzwerk Protokoll hauptsächlich Audio (Low Debit)
- › Mesh-Netzwerk: Elemente sind Empfänger und Sender
- › Einfache Einrichtung
- › Offline nutzbar
- › Energieeffizient

AVANTAGES:

- › Réseau local et sûr
- › Protocole essentiellement audio (bas débit)
- › Réseau maillé : les éléments sont l'émetteur et le récepteur
- › Installation facile
- › Utilisable hors-ligne
- › Économe en énergie

Light up your world!

Bringen Sie Licht in Ihren Alltag!
Illuminez votre quotidien !



connect.z offers a wide range of lamps and lighting equipment. Select products from the following options according to your needs:
connect.z bietet ein großes Sortiment an Leuchten und Leuchtmitteln. Wählen Sie die Produkte ganz nach Ihren Bedürfnissen aus folgenden Varianten:
connect.z propose une large gamme de luminaires et d'ampoules. Sélectionnez les produits en fonction de vos besoins parmi les variantes suivantes :

Warm White

Neutral White

Tunable White

Individual light from 50,000 white tones.
Individuelles Licht aus 50.000 Weißtönen.
Luminaire individuel à 50 000 tons de blanc.

TW + RGB Colors

Diverse lighting selection from 50,000 white tones and 16 million colours.
Vielseitige Lichtauswahl aus 50.000 Weißtönen und 16 Mio. Farben.
Sélection étendue de luminaires à 50 000 tons de blanc et 16 millions de couleurs.

Enjoy relaxing moments!
Genießen Sie entspannte Momente!
Profitez de moments de détente !

Stay focussed & efficient!
Bleiben Sie konzentriert & leistungsfähig!
Restez concentré(e) et performant(e) !

Start the day fresh every morning!
Starten Sie jeden Morgen frisch in den Tag!
Commencez la journée du bon pied !

Create the perfect atmosphere!
Kreieren Sie Ihr perfektes Ambiente!
Créez votre ambiance parfaite !

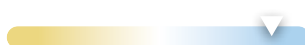

Enjoy many useful convenience features:

Es erwarten Sie viele nützliche Komfortfunktionen:
De nombreuses fonctionnalités utiles vous attendent pour votre confort :



TIMERS AND CALENDARS / TIMER UND ZEITPLÄNE/ MINUTERIE ET CALENDRIER

Make your daily life easier with timers and calendars.
Wake up relaxed with the simulated sunrise.

Unterstützen Sie Ihren Alltag mit Timern und Zeitplänen. Entwickeln Sie eigene Lichtroutinen und machen Sie Ihr Leben leichter.

Facilitez-vous la vie à l'aide de la fonction minuterie et calendrier.
Réveillez-vous en douceur grâce au simulateur de lever de soleil



LIGHT ALARM CLOCK/ LICHTWECKER/ REVEIL LUMINEUX

You'd rather not start your day in a bad mood? Wake up relaxed with the simulated sunrise.

Keine Lust mit schlechter Laune in den Tag zu starten? Entspannt aufwachen mit dem simulierten Sonnenaufgang.

Pas envie de commencer la journée de mauvaise humeur ? Réveillez-vous en douceur grâce au simulateur de lever de soleil.



DISCO FUNCTION/MODE/ DISCOFUNKTION/MODUS/ FONCTION/MODE DISCO

For the perfect party mood, the disco function synchronises the light to the beat of your favourite songs.

Für die perfekte Partystimmung schaltet die Discofunktion das Licht passend zum Beat Ihres Lieblingsongs.

Pour une ambiance festive parfaite, la fonction disco enclenche le luminaire au rythme de votre chanson préférée.



PRESENCE SIMULATOR/ ANWESENHEITSSIMULATION/ SIMULATEUR DE PRESENCE

Protect your home with the convenient presence simulator. Variable time intervals allow the system to turn the lights on and off to simulate your presence at home and deter unwanted guests.

Schütze Sie Ihr Zuhause mit der komfortablen Anwesenheitssimulation. Dank variabler Zeitintervalle simuliert das System durch Ein- und Ausschalten der Beleuchtung die Anwesenheit im Haus und schreckt so ungebetene Gäste ab.

Protégez votre domicile à l'aide du très pratique simulateur de présence. Le système simule votre présence en allumant et en éteignant les lumières à intervalles variables et décourage ainsi les invités indésirables.

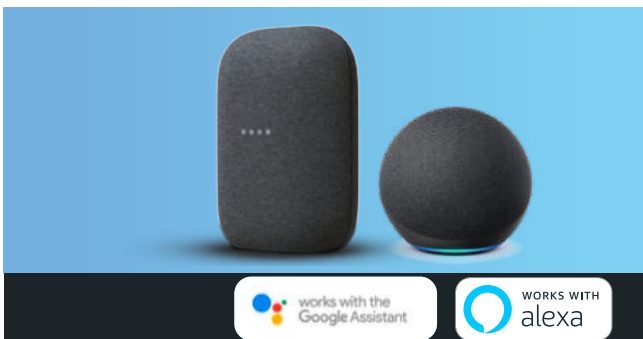

VOICE COMMANDS/ SPRACHSTEUERUNG/COMMANDE VOCALE

More convenient! Turn the light on whenever you want with only a voice command.

Noch komfortabler! Mit nur einem Sprachbefehl schaltet sich das Licht nach Ihren Wünschen an und aus.

C'est encore plus confortable ! Allumez votre luminaire comme vous le souhaitez d'une simple commande vocale.

Control options

Steuerungsmöglichkeiten
Possibilités de commande



Set your smart home as you prefer! With the app, voice commands, or remote control.

Steuern Sie Ihr Smart Home wie Sie es möchten! Via App, Sprachsteuerung oder mit der Fernbedienung.

Commandez votre Smart Home comme vous le souhaitez ! Via l'appli, la commande vocale ou la télécommande.



APP CONTROL

Use the free app for smartphone, tablet, or smartwatch.

Nutzen Sie die kostenlose App für das Smartphone, Tablet oder die Smartwatch.

Utilisez l'appli gratuite sur votre smartphone, votre tablette ou votre montre connectée.



VOICE COMMANDS

Use intelligent voice assistants such as Google Home and Amazon Alexa.

Nutzen Sie intelligente Sprachassistenten wie Google Home und Amazon Alexa.

Utilisez des assistants vocaux intelligents comme Google Home ou Amazon Alexa.



REMOTE CONTROL

Use the practical remote connect.z operation at any time.

Nutzen Sie auch jederzeit die praktische connect.z Fernbedienung.

Vous pouvez aussi utiliser à tout moment la télécommande connect.z.



CONNECT.Z ACCESSORIES

Use clever accessories such as the movement sensor and much more.

Nutzen Sie cleveres Zubehör wie z.B. den Bewegungssensor uvm.

Utilisez des accessoires malins tels que le capteur de mouvement et bien d'autres encore.



DIMMER FUNCTION

Use the practical dimmer function via app, speech command or remote control.

Nutzen Sie die praktische Dimmfunktion via App, Sprachbefehl oder Fernbedienung.

Utilisez la fonction de gradation via l'appli, la commande vocale ou la télécommande.

One system, many possibilities!

Ein System – viele Möglichkeiten!
Un système, de nombreuses possibilités!

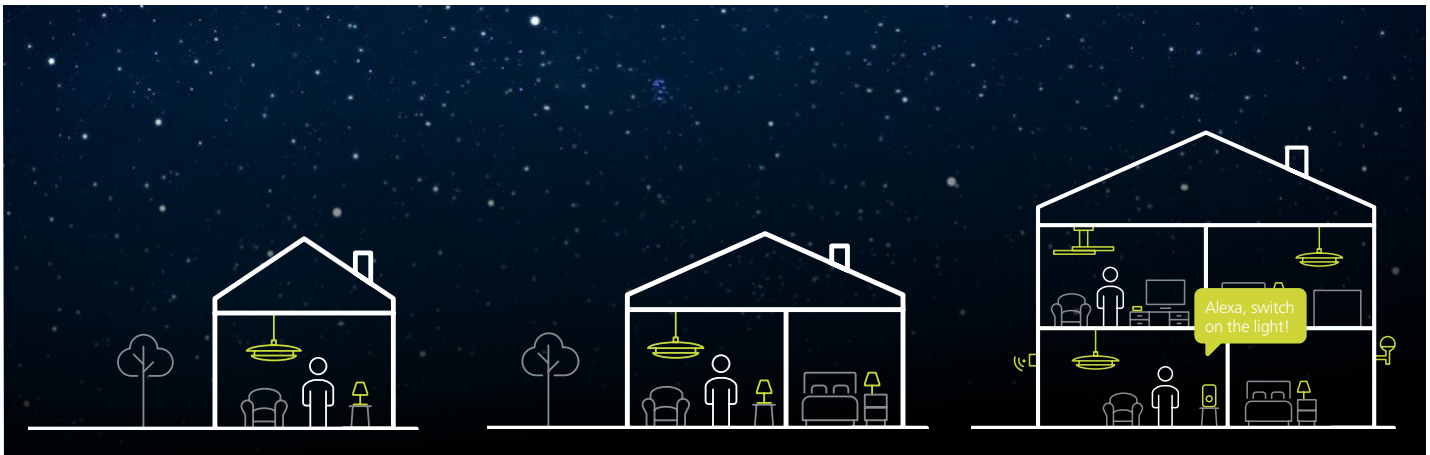

No matter how you start, you can integrate new products into your connect.z system at any time and gradually expand your smart home.
Egal wie Sie starten, Sie können jederzeit neue Produkte in Ihr connect.z System integrieren und Ihr smartes Zuhause nach und nach erweitern.
Quel que soit votre choix, vous pouvez à tout moment intégrer de nouveaux produits à votre système connect.z et améliorer progressivement votre maison intelligente.



BASIC USER

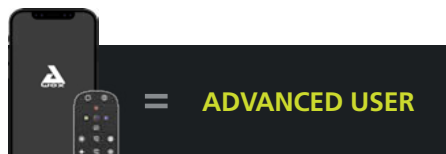

ADVANCED USER



POWER USER

All you need to start is a connect.z product and the remote control. No internet connection is required and you have access to:

Sie benötigen zum Start lediglich ein connect.z Produkt und die Fernbedienung. Es wird kein Internetzugang benötigt und Sie haben Zugriff auf:

Pour démarrer, il vous suffit d'un produit connect.z et de la télécommande. Aucune connexion Internet n'est nécessaire. Vous avez accès aux :

Standard functions: Standardfunktionen: Fonctionnalités standard :

- › Select colour/ Farbauswahl/ sélection de couleur
- › Change colour/ Farbwechsel/ changement decouleur
- › Dim/ Dimmen/ gradation
- › Favourites (2x)/ Favoriten (2x)/ favoris (2x)
- › Groups (3x)/ Gruppen (3x)/ groupes (3x)
- › Candle mode/ Kerzenmodus/ mode bougie

Besides the standard functions, would you also like access to the practical convenience features? Then you need only your smartphone or tablet and the Awox app. This app allows you to control your lights via WIFI and Bluetooth®.

Sie möchten zu den Standardfunktionen auch noch Zugriff auf die praktischen Komfortfunktionen haben? Dann benötigen Sie nur Ihr Smartphone oder Tablet und die Awox App. Mit der App haben Sie die Möglichkeit, Ihre Leuchten über WLAN und Bluetooth® zu steuern.

Outre les options standard, vous souhaitez également pouvoir utiliser les fonctionnalités de confort les plus pratiques ? Pour cela, vous avez seulement besoin de votre smartphone ou de votre tablette et de l'appli Awox. L'appli vous permet de commander vos luminaires via le réseau Wi-Fi ou Bluetooth®.

Standard functions + convenience features/ Standardfunktionen + Komfortfunktionen / Fonctionnalités standard + confort

- › Light alarm clock/ Lichtwecker/ réveil lumineux
- › Presence simulation/ Anwesenheitssimulation/ simulateur de présence
- › Disco function/ Discofunktion/ fonction disco
- › Timers & timetables /Timer & Zeitpläne/ minuteur et calendrier
- › Accessories can be incorporated/ Einbindung von Zubehör möglich/ connexion d'accessoires possible

Use the system's full potential and control your smart home through the Awox app using WIFI or Bluetooth® as well as integrating a voice assistant into the system. This gives you:

Nutzen Sie das volle Potenzial des Systems und steuern Sie Ihr Smart Home über die Awox App mithilfe von WLAN oder Bluetooth® und integrieren Sie zusätzlich noch einen Sprachassistenten in das System. So mit erhalten Sie:

Exploitez tout le potentiel du système en commandant votre Smart Home grâce à l'appli Awox via le réseau Wi-Fi ou Bluetooth®, et intégrez également un assistant vocal au système. Vous obtenez ainsi :

Standard functions + convenience features + voice commands*

Standardfunktionen + Komfortfunktionen + Sprachsteuerung*

Fonctionnalités standard + confort + commande vocale*

- › Amazon Alexa or Google Home/ Amazon Alexa oder Google Home/ Amazon Alexa ou Google Home

- * Use a voice assistant with integrated bridge.
- * Nutzen Sie einen Sprachassistenten mit integrierter Bridge.
- * Utilisez un assistant vocal avec Bridge intégré.

YOU ALREADY HAVE CONNECT-C LUMINAIRES FROM THE PREVIOUS SYSTEM! WHAT NOW?

Sie besitzen bereits connect-c Leuchten des Vorgängersystems! Was nun?
Vous disposez déjà de luminaires connect-c de l'ancien système! Que faire ?

No problem! The previous connect-c products are compatible with the new connect.z system.
Kein Problem! Die bisherigen connect-c Produkte sind mit dem neuen connect.z System kompatibel.
Aucun problème! Les anciens produits connect-c sont compatibles avec le nouveau système connect.z.

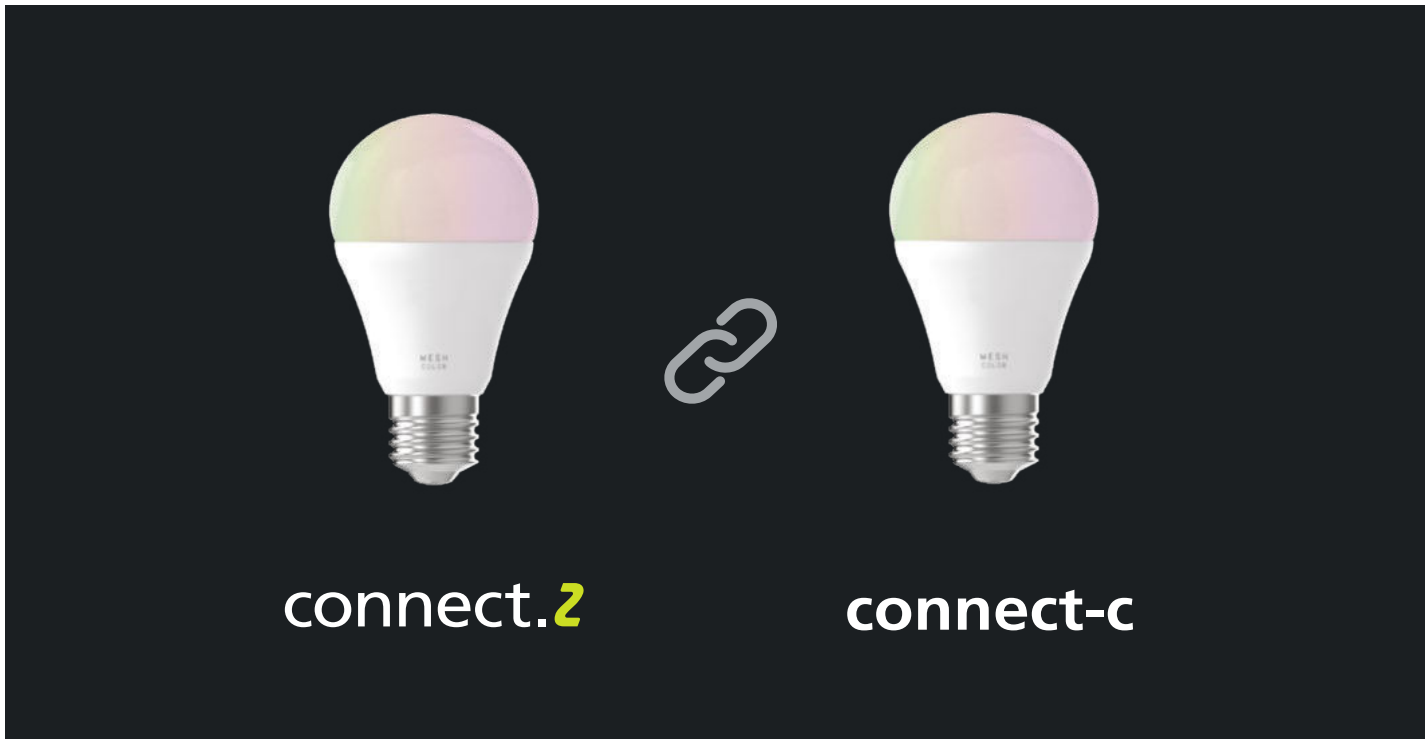

EGLO connect-c - connect.z

The existing EGLO connect-c system is compatible with the new EGLO connect.z system. You don't need to switch from the existing Bluetooth low energy system to the new open protocol ZigBee 3.0. Lights from EGLO connect-c can be incorporated into the existing EGLO connect.z system.

EGLO connect-c - connect.z

Das bestehende EGLO connect-c System ist mit dem neuen EGLO connect.z System kompatibel. Sie müssen nicht von dem bestehendem Bluetooth low energy System auf das neue offene Protokoll ZigBee 3.0 umsteigen. Leuchten von EGLO connect-c können in das bestehende EGLO connect.z System eingebunden werden.

EGLO connect-c - connect.z

Le système EGLO connect-c existant est compatible avec le nouveau système EGLO connect.z. Vous n'avez pas besoin de passer du système Bluetooth à basse consommation existant au nouveau protocole ouvert ZigBee 3.0. Les luminaires EGLO connect-c peuvent être intégrés au système EGLO connect.z existant.



99106



120°, 12 m
20 sec. - 10 min.



99099



wall bracket incl.
Montagehalterung inkl.
support mural incl.



33994

99106 CONNECT-Z SENSOR

accessory; plastic, white
Zubehör; Kunststoff, weiss
accessoire; plastique, blanc

L 75, H 75, A 70



AA,
LR6 HP



2900mA,
1,5V



IP44



9 002759 991067



33994 CONNECT Z

remote control; plastic, white
Fernbedienung; Kunststoff, weiss
Télécommande; plastique, blanc

L 56, B 24, H 112



AAA,
Zink-Car-
bon, R03



1,5V



9 002759 339944



99099 REMOTE 2.0

remote control; plastic, grey
Fernbedienung; Kunststoff, grau
Télécommande; plastique, gris

L 122, B 54, H 18



AAA,
R03P



1,5V



9 002759 990992





900075 VALDELAGRANO-Z

pendant light; steel, wood, black / fabric, white
 Hängeleuchte; Stahl, Holz, schwarz / Textil, weiss
 luminaire en suspension; acier, bois, noir / tissu, blanc

L 1000, B 105, H 1100

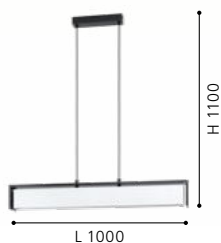
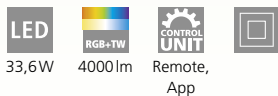

99603 SIMOLARIS-Z

pendant light; aluminium, steel, black / plastic, white
 Hängeleuchte; Alu, Stahl, schwarz / Kunststoff, weiss
 luminaire en suspension; aluminium, acier, noir / plastique, blanc

L 1220, B 55, H 1100

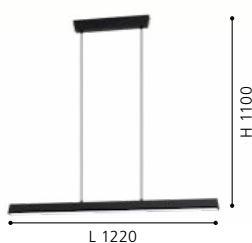
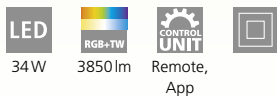

99601 SIMOLARIS-Z

ceiling light; aluminium, steel, black / plastic, white
 Deckenleuchte; Alu, Stahl, schwarz / Kunststoff, weiss
 plafonnier; aluminium, acier, noir / plastique, blanc

L 470, B 55, H 110





99602



99604

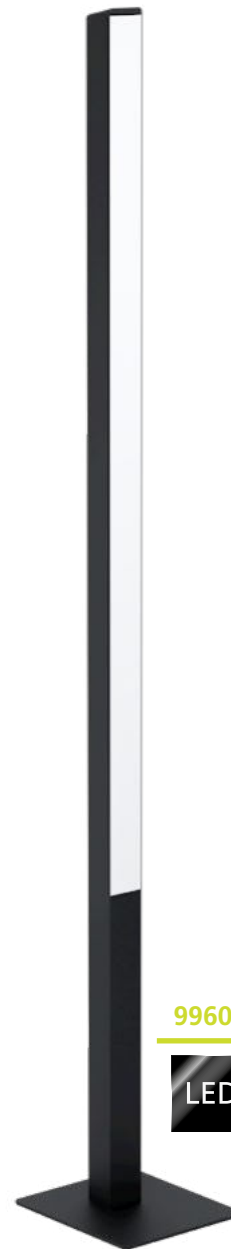

99605



99602 SIMOLARIS-Z

ceiling light; aluminium, steel, black / plastic, white
Deckenleuchte; Alu, Stahl, schwarz / Kunststoff, weiss
plafonnier; aluminium, acier, noir / plastique, blanc

L 1220, B 55, H 110

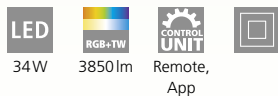

99604 SIMOLARIS-Z

table light; aluminium, steel, black / plastic, white
Tischleuchte; Alu, Stahl, schwarz / Kunststoff, weiss
luminaire de table; aluminium, acier, noir / plastique, blanc

L 55, B 55, H 515, Base: B 160, T 120



99605 SIMOLARIS-Z

floor light; aluminium, steel, black / plastic, white
Stehleuchte; Alu, Stahl, schwarz / Kunststoff, weiss
lampadaire; aluminium, acier, noir / plastique, blanc

L 55, B 55, H 1615, Base: B 240, T 210



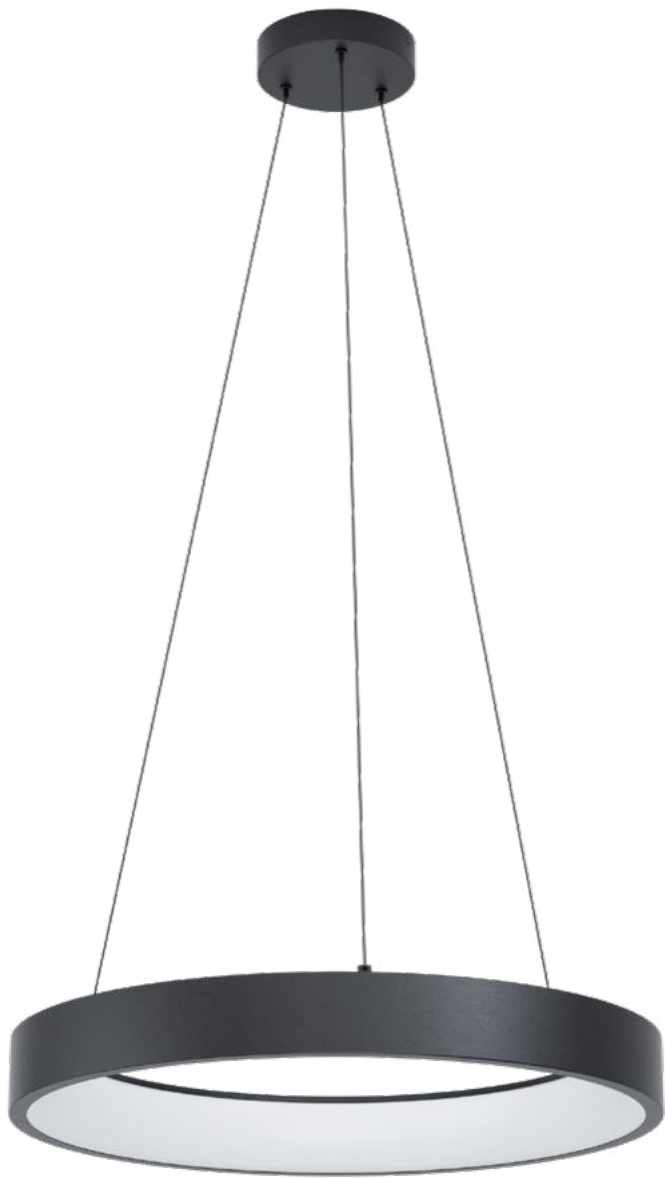

900068



900067



900069



900068 MARGHERA-Z

pendant light; steel, black / plastic, white
 Hängeleuchte; Stahl, schwarz / Kunststoff, weiss
 luminaire en suspension; acier, noir / plastique, blanc

H 1100, Ø 600



27W

3200lm

Remote,
App



9 008606 222032



900067 MARGHERA-Z

ceiling light; steel, black / plastic, white
 Deckenleuchte; Stahl, schwarz / Kunststoff, weiss
 plafonnier; acier, noir / plastique, blanc

H 110, Ø 600



27W

3200lm

Remote,
App



9 008606 222025



900069 MARGHERA-Z

wall light; steel, black / plastic, white
 Wandleuchte; Stahl, schwarz / Kunststoff, weiss
 applique; acier, noir / plastique, blanc

L 270, H 305, A 200



16W

1900lm

Remote,
App



9 008606 222049





900071



900072



900071 MARGHERA-Z

table light; steel, black / plastic, white
Tischleuchte; Stahl, schwarz / Kunststoff, weiss
luminaire de table; acier, noir / plastique, blanc

L 270, H 265, Base: Ø 145

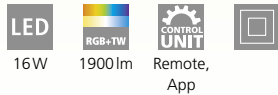

9 008606 222056



900072 MARGHERA-Z

floor light; steel, black / plastic, white
Stehleuchte; Stahl, schwarz / Kunststoff, weiss
lampadaire; acier, noir / plastique, blanc

L 270, B 305, H 1690, Base: Ø 305

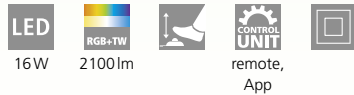

9 008606 222063

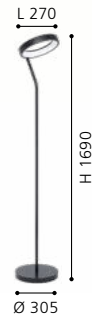



99673

LED



99674

LED



99675

LED



99673 CAMINALES-Z

ceiling light; steel, black
Deckenleuchte; Stahl, schwarz
plafonnier; acier, noir

L 125, B 125, H 120

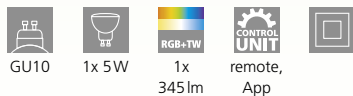

99674 CAMINALES-Z

ceiling light; steel, black
Deckenleuchte; Stahl, schwarz
plafonnier; acier, noir

L 240, B 125, H 120

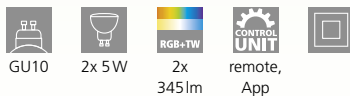

99675 CAMINALES-Z

ceiling light; steel, black
Deckenleuchte; Stahl, schwarz
plafonnier; acier, noir

L 240, B 240, H 120

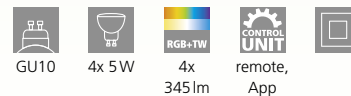

9 002759 996734

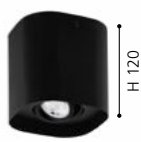

L 125



9 002759 996741



L 240



9 002759 996758



L 240



99669

LED



DESIGN
HIGHLIGHT
DETAIL



99671

LED



99672

LED

99669 SALICETO-Z

recessed light; aluminium, black
Einbauleuchte; Alu, schwarz
luminaire encastrable; aluminium, noir

H 46, Ø 88, ET 50

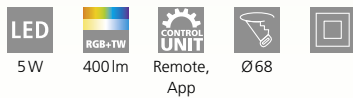

99671 SALICETO-Z

recessed light; aluminium, white
Einbauleuchte; Alu, weiss
luminaire encastrable; aluminium, blanc

H 46, Ø 88, ET 50

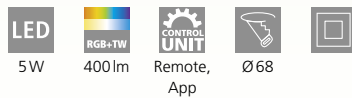

99672 SALICETO-Z

recessed light; aluminium, satin nickel
Einbauleuchte; Alu, nickel-matt
luminaire encastrable; aluminium, nickel mat

H 46, Ø 88, ET 50

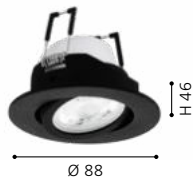
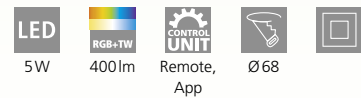

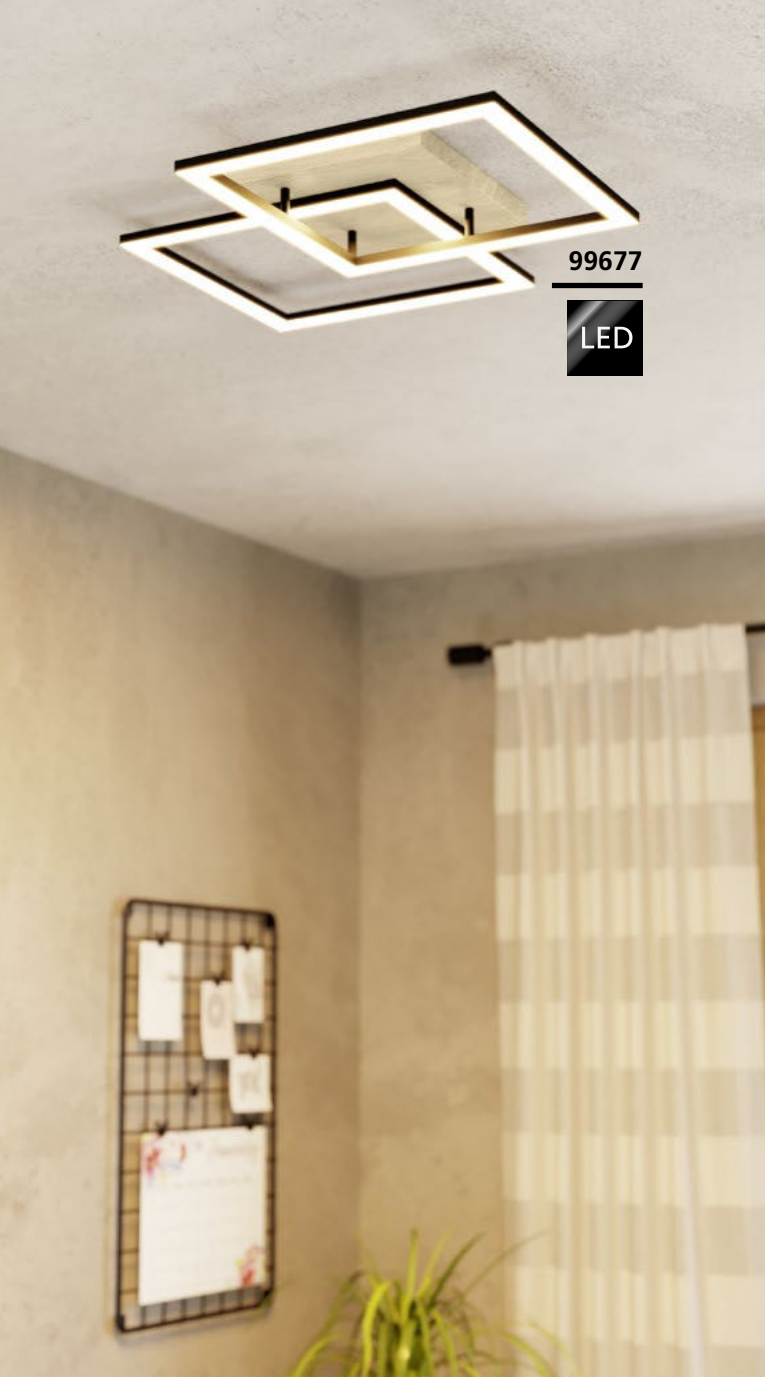

99677

LED



99676

LED



99677 LOMALTAS-Z

ceiling light; steel, wood, black, brown / plastic, white
 Deckenleuchte; Stahl, Holz, schwarz, braun / Kunststoff, weiss
 plafonnier; acier, bois, noir, marron / plastique, blanc

L 770, B 495, H 85



2x 16W 3800lm Remote, App

99676 LOMALTAS-Z

ceiling light; steel, wood, black, brown / plastic, white
 Deckenleuchte; Stahl, Holz, schwarz, braun / Kunststoff, weiss
 plafonnier; acier, bois, noir, marron / plastique, blanc

L 580, B 350

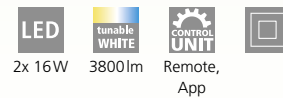

2x 16W 3800lm Remote, App

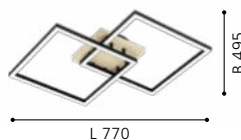



900019

LED



900021

LED



99588

LED

900019 TABIANO-Z

mirror light; steel, chrome / plastic, white
Spiegelleuchte; Stahl, chrom / Kunststoff, weiss
applique pour miroir; acier, chrome / plastique, blanc

L 605, H 70, A 135

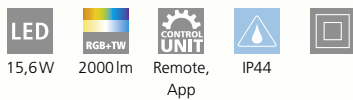

15,6W 2000lm Remote, App

900021 TABIANO-Z

mirror light; steel, chrome / plastic, white
Spiegelleuchte; Stahl, chrom / Kunststoff, weiss
applique pour miroir; acier, chrome / plastique, blanc

L 905, H 70, A 135

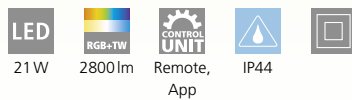

21W 2800lm Remote, App

99588 JUAREZA-Z

mirror light; steel, white / mirror
Spiegelleuchte; Stahl, weiss / Spiegel
applique pour miroir; acier, blanc / miroir

L 700, H 500, A 55

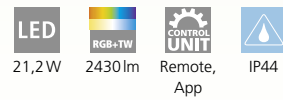

21,2W 2430lm Remote, App



9 008606 221646



9 008606 221653

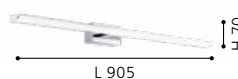

9 002759 995881





900079

LED



900081

LED



900082

LED



900079 FRAIOLI-Z

ceiling light; aluminium, black / plastic, white
 Deckenleuchte; Alu, schwarz / Kunststoff, weiss
 plafonnier; aluminium, noir / plastique, blanc

L 1055, B 120, H 65

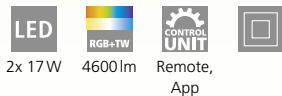

2x 17W 4600lm Remote, App



9 008606 223565

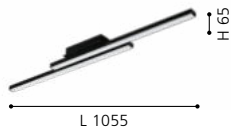

900081 FRAIOLI-Z

pendant light; aluminium, black / plastic, white
 Hängeleuchte; Alu, schwarz / Kunststoff, weiss
 luminaire en suspension; aluminium, noir / plastique, blanc

L 1055, B 100, H 1200

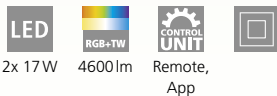

2x 17W 4600lm Remote, App



9 008606 223572



900082 FRAIOLI-Z

floor light; aluminium, black / plastic, white
 Stehleuchte; Alu, schwarz / Kunststoff, weiss
 lampadaire; aluminium, noir / plastique, blanc

H 1755, Base: B 280, T 280



2x 17W 4600lm remote, App



9 008606 223589

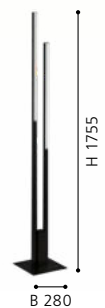



900076

LED



900077

LED



900078

LED

900076 FRAIOLI-Z

ceiling light; aluminium, satin nickel / plastic, white
Deckenleuchte; Alu, nickel-matt / Kunststoff, weiss
plafonnier; aluminium, nickel mat / plastique, blanc

L 1055, B 120, H 65

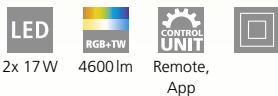

2x 17W 4600lm Remote, App



9 008606 223534



L 1055

900077 FRAIOLI-Z

pendant light; aluminium, satin nickel / plastic, white
Hängeleuchte; Alu, nickel-matt / Kunststoff, weiss
luminaire en suspension; aluminium, nickel mat / plastique, blanc

L 1055, B 100, H 1200



2x 17W 4600lm Remote, App



9 008606 223541



L 1055

900078 FRAIOLI-Z

floor light; aluminium, satin nickel / plastic, white
Stehleuchte; Alu, nickel-matt / Kunststoff, weiss
lampadaire; aluminium, nickel mat / plastique, blanc

H 1755, Base: B 280, T 280

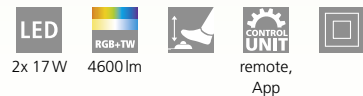

2x 17W 4600lm remote, App



9 008606 223558



B 280



900001



900002



900084



900001 TOTARI-Z

ceiling light; steel, white / plastic with crystal effect, white
Deckenleuchte; Stahl, weiss / Kunststoff m. Kristalleffekt, weiss
plafonnier; acier, blanc / plastique avec effet cristal, blanc

H 70, Ø 380



900002 TOTARI-Z

ceiling light; steel, white / plastic with crystal effect, white
Deckenleuchte; Stahl, weiss / Kunststoff m. Kristalleffekt, weiss
plafonnier; acier, blanc / plastique avec effet cristal, blanc

H 70, Ø 560



900084 TOTARI-Z

ceiling light; steel, white / plastic, white
Deckenleuchte; Stahl, weiss / Kunststoff, weiss
plafonnier; acier, blanc / plastique, blanc

H 70, Ø 380

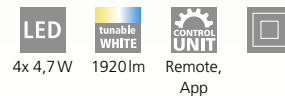

9 008606 221479



9 008606 221486



9 008606 225453



900085

LED



900085 TOTARI-Z

ceiling light; steel, white / plastic, white
Deckenleuchte; Stahl, weiss / Kunststoff, weiss
plafonnier; acier, blanc / plastique, blanc

H 70, Ø 560

LED

4x 8,1 W

tunable
WHITE

3600 lm

CONTROL
UNIT

Remote,
App



9 008606 225460





900083



900005



900006



900083 LANCIANO-Z

ceiling light; steel, white, transparent / plastic with crystal effect, white, chrome

Deckenleuchte; Stahl, weiss, transparent / Kunststoff m.Kristall-effekt, weiss, chrom

plafonnier; acier, blanc, transparent / plastique avec effet cristal, blanc, chrome
H 80, Ø 450



4x 4,7W 1920lm Remote, App

900005 LANCIANO-Z

ceiling light; steel, white, transparent / plastic with crystal effect, white, chrome

Deckenleuchte; Stahl, weiss, transparent / Kunststoff m.Kristall-effekt, weiss, chrom

plafonnier; acier, blanc, transparent / plastique avec effet cristal, blanc, chrome
H 80, Ø 560



4x 8,1W 3600lm Remote, App

900006 LANCIANO-Z

ceiling light; steel, white, transparent / plastic with crystal effect, white, chrome

Deckenleuchte; Stahl, weiss, transparent / Kunststoff m.Kristall-effekt, weiss, chrom

plafonnier; acier, blanc, transparent / plastique avec effet cristal, blanc, chrome
H 95, Ø 770



38W 4800lm Remote, App



9 008606 225446



9 008606 221516



9 008606 221523





900008

LED



900128

LED



900129

LED

900008 CAPASSO-Z

wall / ceiling light; steel, white / plastic, white, chrome
Wand- / Deckenleuchte; Stahl, weiss / Kunststoff, weiss, chrom
applique / plafonnier; acier, blanc / plastique, blanc, chrome

H 70, Ø 340



4x 3,9W



1680lm



Remote,
App



9 008606 221547



900128 SILERAS-Z

ceiling light; steel, white / plastic with crystal effect, white
Deckenleuchte; Stahl, weiss / Kunststoff m.Kristalleffekt, weiss
plafonnier; acier, blanc / plastique avec effet cristal, blanc

H 60, Ø 430



3x 7,1W



2400lm



Remote,
App



9 008606 226054

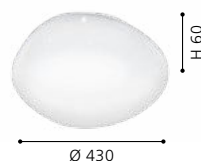

900129 SILERAS-Z

ceiling light; steel, white / plastic with crystal effect, white
Deckenleuchte; Stahl, weiss / Kunststoff m.Kristalleffekt, weiss
plafonnier; acier, blanc / plastique avec effet cristal, blanc

H 60, Ø 600



3x 11 W



3900lm



Remote,
App



9 008606 226061





900025

LED

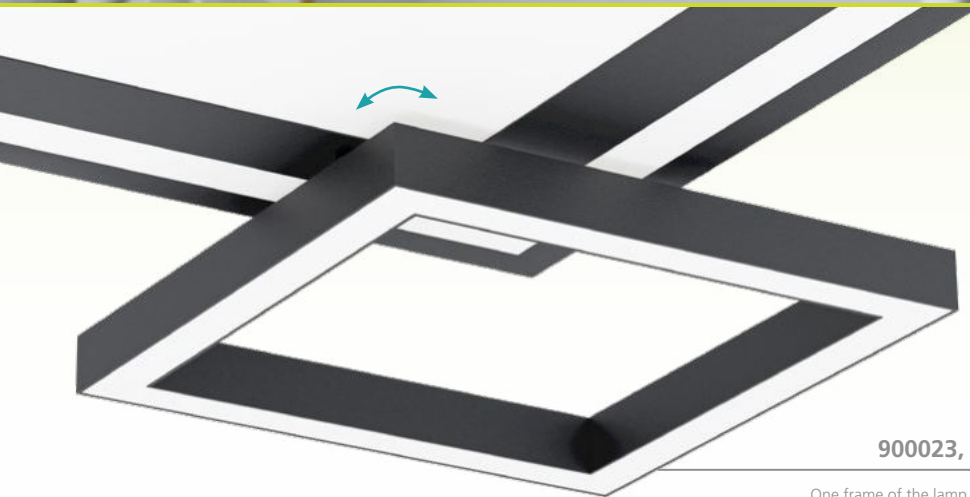

900025 SAVATARILA-Z

ceiling light; steel, black / plastic, white
 Deckenleuchte; Stahl, schwarz / Kunststoff, weiss
 plafonnier; acier, noir / plastique, blanc

L 450, B 450, H 70



21 W



2400 lm



Remote,
App



900023, 900025

One frame of the lamp is rotatable.

Ein Rahmen der Leuchte ist drehbar.

Un cadre de la lampe est rotatif.

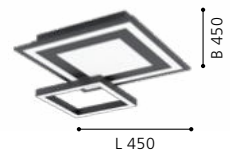



900023 SAVATARILA-Z

ceiling light; steel, white / plastic, white
Deckenleuchte; Stahl, weiss / Kunststoff, weiss
plafonnier; acier, blanc / plastique, blanc

L 450, B 450, H 70

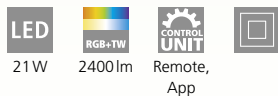

900022 SALITERAS-Z

ceiling light; steel, white / plastic, white
Deckenleuchte; Stahl, weiss / Kunststoff, weiss
plafonnier; acier, blanc / plastique, blanc

L 1160, B 160, H 50

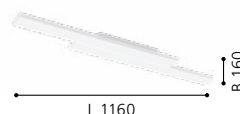

900024 SALITERAS-Z

ceiling light; steel, black / plastic, white
Deckenleuchte; Stahl, schwarz / Kunststoff, weiss
plafonnier; acier, noir / plastique, blanc

L 1160, B 160, H 50

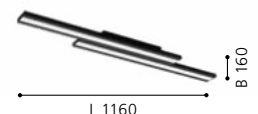



900054



900056



TURCONA-Z

Frameless luminaire

Rahmenlose Leuchte

Luminaire sans cadre



900054 TURCONA-Z

ceiling light; steel, aluminium, white / plastic, white
Deckenleuchte; Stahl, Alu, weiss / Kunststoff, weiss
plafonnier; acier, aluminium, blanc / plastique, blanc

H 60, Ø 300

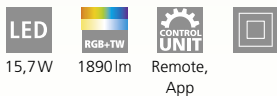

15,7W 1890lm Remote, App

900056 TURCONA-Z

ceiling light; steel, aluminium, white / plastic, white
Deckenleuchte; Stahl, Alu, weiss / Kunststoff, weiss
plafonnier; acier, aluminium, blanc / plastique, blanc

H 60, Ø 600



34,2W 4100lm Remote, App

900055 TURCONA-Z

ceiling light; steel, aluminium, white / plastic, white
Deckenleuchte; Stahl, Alu, weiss / Kunststoff, weiss
plafonnier; acier, aluminium, blanc / plastique, blanc

H 60, Ø 450

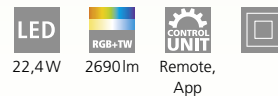

22,4W 2690lm Remote, App



9 008606 221905



9 008606 221929

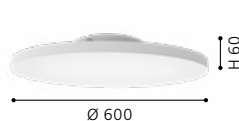

9 008606 221912





900055

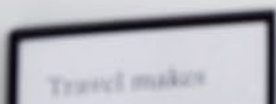



99548



99549



99548 HERRORA-Z

ceiling light; aluminium, white / plastic, white
Deckenleuchte; Alu, weiss / Kunststoff, weiss
plafonnier; aluminium, blanc / plastique, blanc

L 595, B 595, H 40

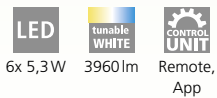

99549 HERRORA-Z

ceiling light; aluminium, white / plastic, white
Deckenleuchte; Alu, weiss / Kunststoff, weiss
plafonnier; aluminium, blanc / plastique, blanc

L 1200, B 300, H 40



99639 HERRORA-Z

ceiling light; aluminium, white / plastic, white
Deckenleuchte; Alu, weiss / Kunststoff, weiss
plafonnier; aluminium, blanc / plastique, blanc

L 450, B 450, H 40



9 002759 995485



9 002759 995492



9 002759 996390





99639





900057



900058



900059



TURCONA-Z

Frameless luminaire

Rahmenlose Leuchte

Luminaire sans cadre

900057 TURCONA-Z

ceiling light; steel, aluminium, white / plastic, white
Deckenleuchte; Stahl, Alu, weiss / Kunststoff, weiss
plafonnier; acier, aluminium, blanc / plastique, blanc

L 300, B 300, H 50



16W



1940lm



Remote,
App



900058 TURCONA-Z

ceiling light; steel, aluminium, white / plastic, white
Deckenleuchte; Stahl, Alu, weiss / Kunststoff, weiss
plafonnier; acier, aluminium, blanc / plastique, blanc

L 450, B 450, H 50



6x 3,8W



2760lm



Remote,
App



900059 TURCONA-Z

ceiling light; steel, aluminium, white / plastic, white
Deckenleuchte; Stahl, Alu, weiss / Kunststoff, weiss
plafonnier; acier, aluminium, blanc / plastique, blanc

L 600, B 600, H 50



6x 5,4W



4260lm



Remote,
App



9 008606 221936

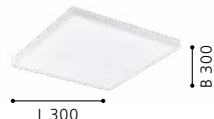

9 008606 221943

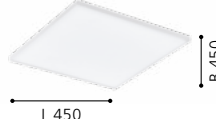

9 008606 221950

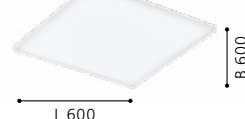



900062

LED



900061

LED

900062 TURCONA-Z

ceiling light; steel, aluminium, white / plastic, white
Deckenleuchte; Stahl, Alu, weiss / Kunststoff, weiss
plafonnier; acier, aluminium, blanc / plastique, blanc

L 1200, B 100, H 50

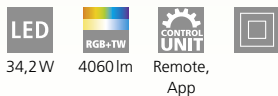

34,2W

4060lm

Remote,
App

900061 TURCONA-Z

ceiling light; steel, aluminium, white / plastic, white
Deckenleuchte; Stahl, Alu, weiss / Kunststoff, weiss
plafonnier; acier, aluminium, blanc / plastique, blanc

L 1200, B 300, H 50

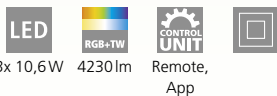

3x 10,6W

4230lm

Remote,
App



9 008606 221974

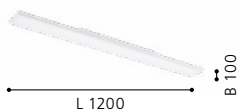

9 008606 221967

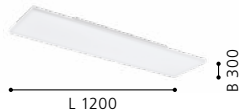



900044



900045



900046



900044 SALOBRENA-Z

ceiling light; aluminium, white / plastic, white
Deckenleuchte; Alu, weiss / Kunststoff, weiss
plafonnier; aluminium, blanc / plastique, blanc

L 300, B 300, H 50

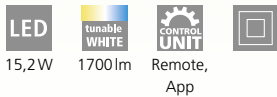

15,2W 1700lm Remote, App

900045 SALOBRENA-Z

ceiling light; aluminium, white / plastic, white
Deckenleuchte; Alu, weiss / Kunststoff, weiss
plafonnier; aluminium, blanc / plastique, blanc

L 450, B 450, H 50



21,4W 2390lm Remote, App

900046 SALOBRENA-Z

ceiling light; aluminium, white / plastic, white
Deckenleuchte; Alu, weiss / Kunststoff, weiss
plafonnier; aluminium, blanc / plastique, blanc

L 595, B 595, H 50

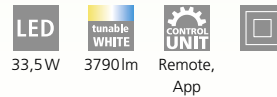

33,5W 3790lm Remote, App



9 008606 221813



9 008606 221820

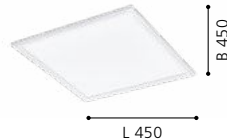

9 008606 221837





900047



900048



900047 SALOBRENA-Z

ceiling light; aluminium, white / plastic, white
 Deckenleuchte; Alu, weiss / Kunststoff, weiss
 plafonnier; aluminium, blanc / plastique, blanc

L 1200, B 300, H 50

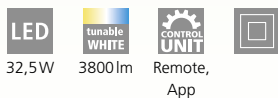

32,5W 3800lm Remote, App



9 008606 221844



900048 SALOBRENA-Z

ceiling light; aluminium, white / plastic, white
 Deckenleuchte; Alu, weiss / Kunststoff, weiss
 plafonnier; aluminium, blanc / plastique, blanc

L 1200, B 100, H 45

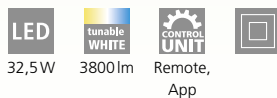

32,5W 3800lm Remote, App



9 008606 221851



ACCESSORIES INCLUDED



900047



900046



900044



900045



Zubehör inkludiert
 Accessoires inclus



900049



900051



900052



900049 SALOBRENA-Z

ceiling light; aluminium, black / plastic, white
Deckenleuchte; Alu, schwarz / Kunststoff, weiss
plafonnier; aluminium, noir / plastique, blanc

L 300, B 300, H 50

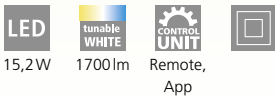

15,2W 1700lm Remote, App



9 008606 221868

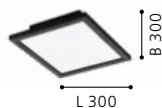

900051 SALOBRENA-Z

ceiling light; aluminium, black / plastic, white
Deckenleuchte; Alu, schwarz / Kunststoff, weiss
plafonnier; aluminium, noir / plastique, blanc

L 450, B 450, H 50

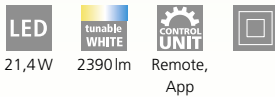

21,4W 2390lm Remote, App



9 008606 221875

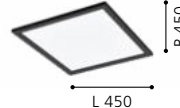

900052 SALOBRENA-Z

ceiling light; aluminium, black / plastic, white
Deckenleuchte; Alu, schwarz / Kunststoff, weiss
plafonnier; aluminium, noir / plastique, blanc

L 595, B 595, H 50

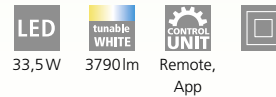

33,5W 3790lm Remote, App



9 008606 221882

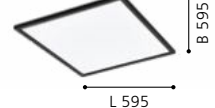



900053



900095



900053 SALOBRENA-Z

ceiling light; aluminium, black / plastic, white
 Deckenleuchte; Alu, schwarz / Kunststoff, weiss
 plafonnier; aluminium, noir / plastique, blanc

L 1200, B 300, H 50

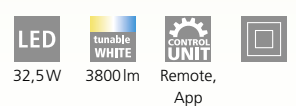

900095 SALOBRENA-Z

ceiling light; aluminium, steel, black / plastic, white
 Deckenleuchte; Alu, Stahl, schwarz / Kunststoff, weiss
 plafonnier; aluminium, acier, noir / plastique, blanc

L 1200, B 100, H 45

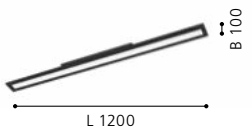
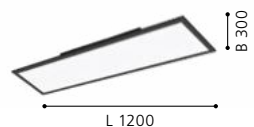



900099

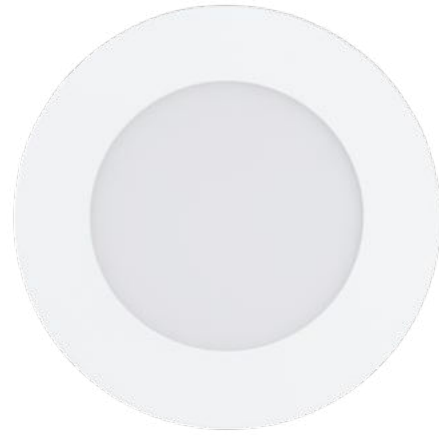

900101

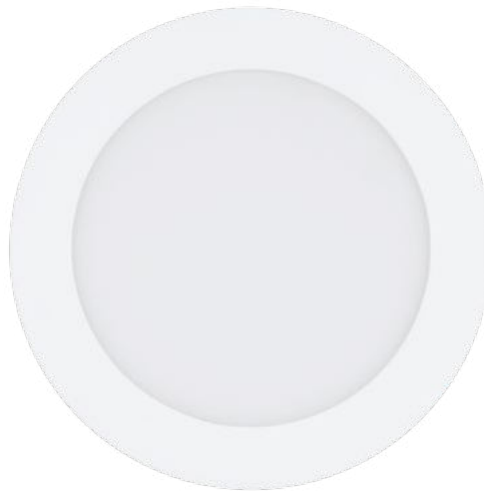

900102



900099 FUEVA-Z

recessed light; steel, white / plastic, white
Einbauleuchte; Stahl, weiss / Kunststoff, weiss
luminaire encastrable; acier, blanc / plastique, blanc

H 26, Ø 85



3x 2,8W 3x 360lm Remote, App Ø75 IP20, IP44



Ø 85

900101 FUEVA-Z

recessed light; steel, white / plastic, white
Einbauleuchte; Stahl, weiss / Kunststoff, weiss
luminaire encastrable; acier, blanc / plastique, blanc

H 26, Ø 120



5,4W 600lm Remote, App Ø105 IP20, IP44



Ø 120

900102 FUEVA-Z

recessed light; steel, white / plastic, white
Einbauleuchte; Stahl, weiss / Kunststoff, weiss
luminaire encastrable; acier, blanc / plastique, blanc

H 26, Ø 165



10,8W 1250lm Remote, App Ø155 IP20, IP44

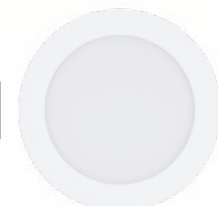

Ø 165



98842 FUEVA-Z

recessed light; aluminium, white / plastic, white
 Einbauleuchte; Alu, weiss / Kunststoff, weiss
 luminaire encastrable; aluminium, blanc / plastique, blanc

Ø 216, ET 26



16,5W



2250lm



Remote,
App



Ø 205



IP20, IP44



Ø 216



900112



900111



900113



900111 FUEVA-Z

recessed light; steel, satin nickel / plastic, white
Einbauleuchte; Stahl, nickel-matt / Kunststoff, weiss
luminaire encastrable; acier, nickel mat / plastique, blanc

H 26, Ø 85



3x 2,8W



3x 360lm



Remote,
App



Ø 75



IP20, IP44



9 008606 225668



Ø 85

900112 FUEVA-Z

recessed light; steel, satin nickel / plastic, white
Einbauleuchte; Stahl, nickel-matt / Kunststoff, weiss
luminaire encastrable; acier, nickel mat / plastique, blanc

H 26, Ø 120



5,4W



600lm



Remote,
App



Ø 105



IP20, IP44



9 008606 225675



Ø 120

900113 FUEVA-Z

recessed light; steel, satin nickel / plastic, white
Einbauleuchte; Stahl, nickel-matt / Kunststoff, weiss
luminaire encastrable; acier, nickel mat / plastique, blanc

H 26, Ø 165



10,8W



1250lm



Remote,
App



Ø 155



IP20, IP44



9 008606 225682



Ø 165



98844

LED

98844 FUEVA-Z

recessed light; aluminium, satin nickel / plastic, white
Einbauleuchte; Alu, nickel-matt / Kunststoff, weiss
luminaire encastrable; aluminium, nickel mat / plastique, blanc

Ø 216, ET 26

LED

16,5W

tunable
WHITE

2250lm

CONTROL
UNIT

Remote,
App

Ø 205

IP20, IP44



Ø 216



900105



900106

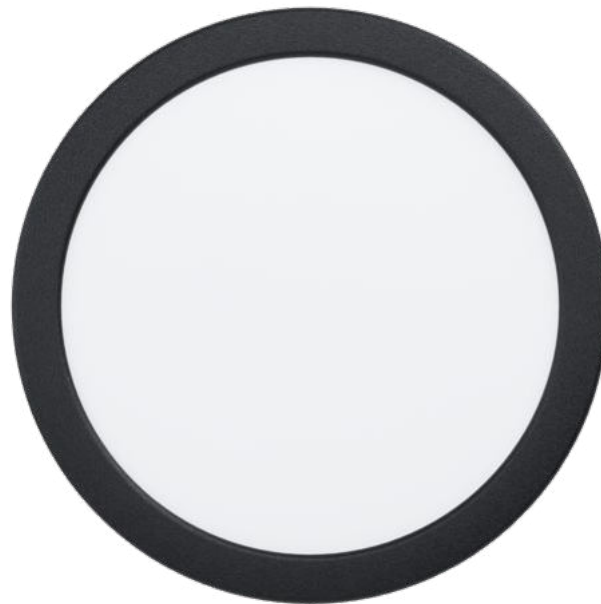

98846



900105 FUEVA-Z

recessed light; steel, black / plastic, white
Einbauleuchte; Stahl, schwarz / Kunststoff, weiss
luminaire encastrable; acier, noir / plastique, blanc

H 26, Ø 85



3x 2,8W 3x 360lm Remote, App Ø 75 IP20, IP44



Ø 85

900106 FUEVA-Z

recessed light; steel, black / plastic, white
Einbauleuchte; Stahl, schwarz / Kunststoff, weiss
luminaire encastrable; acier, noir / plastique, blanc

H 26, Ø 120



5,4W 600lm Remote, App Ø 105 IP20, IP44



Ø 120

98846 FUEVA-Z

recessed light; aluminium, black / plastic, white
Einbauleuchte; Alu, schwarz / Kunststoff, weiss
luminaire encastrable; aluminium, noir / plastique, blanc

Ø 216, ET 26



16,5W 2250lm Remote, App Ø 205 IP20, IP44



Ø 216



900107

LED

900107 FUEVA-Z

recessed light; steel, black / plastic, white

Einbauleuchte; Stahl, schwarz / Kunststoff, weiss

luminaire encastrable; acier, noir / plastique, blanc

H 26, Ø 166



10,8W



1250lm



Remote,
App



Ø 155



IP20, IP44



9 008606 225637



Ø 166



900104

LED



900103

LED



98849

LED

900104 FUEVA-Z

surface-mounted light; steel, white / plastic, white
Aufbauleuchte; Stahl, weiss / Kunststoff, weiss
luminaire en saillie; acier, blanc / plastique, blanc

L 210, B 210, H 28



16,5W



2100lm



Remote,
App



IP44



98849 FUEVA-Z

surface-mounted light; aluminium, white / plastic, white
Aufbauleuchte; Alu, weiss / Kunststoff, weiss
luminaire en saillie; aluminium, blanc / plastique, blanc

L 285, B 285, H 28



19,5W



2700lm



Remote,
App



IP44



900103 FUEVA-Z

surface-mounted light; steel, white / plastic, white
Aufbauleuchte; Stahl, weiss / Kunststoff, weiss
luminaire en saillie; acier, blanc / plastique, blanc

H 28, Ø 210



16,5W



2100lm



Remote,
App



IP44



9 008606 225606



L 210



9 002759 988494



L 285



9 008606 225590



Ø 210



98843 FUEVA-Z

surface-mounted light; aluminium, white / plastic, white
Aufbauleuchte; Alu, weiss / Kunststoff, weiss
luminaire en saillie; aluminium, blanc / plastique, blanc

H 28, Ø 285

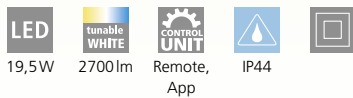

LED

19,5W

tunable
WHITE

2700lm

CONTROL
UNIT

Remote,
App

IP44



98843





900114



900115



98845



900114 FUEVA-Z

surface-mounted light; steel, satin nickel / plastic, white
Aufbauleuchte; Stahl, nickel-matt / Kunststoff, weiss
luminaire en saillie; acier, nickel mat / plastique, blanc

H 28, Ø 210



16,5W



2100lm



Remote,
App



IP44



98845 FUEVA-Z

surface-mounted light; aluminium, satin nickel / plastic, white
Aufbauleuchte; Alu, nickel-matt / Kunststoff, weiss
luminaire en saillie; aluminium, nickel mat / plastique, blanc

H 28, Ø 285



19,5W



2700lm



Remote,
App



IP44



900115 FUEVA-Z

surface-mounted light; steel, satin nickel / plastic, white
Aufbauleuchte; Stahl, nickel-matt / Kunststoff, weiss
luminaire en saillie; acier, nickel mat / plastique, blanc

L 210, B 210, H 28



16,5W



2100lm



Remote,
App



IP44



9 008606 225699



Ø 210



9 002759 988456



Ø 285



9 008606 225705



L 210

B 210



98852 FUEVA-Z

surface-mounted light; aluminium, satin nickel / plastic, white
Aufbauleuchte; Alu, nickel-matt / Kunststoff, weiss
luminaire en saillie; aluminium, nickel mat / plastique, blanc

L 285, B 285, H 28

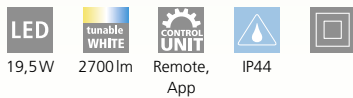

98852





900108



98854



98847



900108 FUEVA-Z

surface-mounted light; steel, black / plastic, white
Aufbauleuchte; Stahl, schwarz / Kunststoff, weiss
luminaire en saillie; acier, noir / plastique, blanc

H 28, Ø 210



16,5W



2100lm



Remote,
App



IP44



98847 FUEVA-Z

surface-mounted light; aluminium, black / plastic, white
Aufbauleuchte; Alu, schwarz / Kunststoff, weiss
luminaire en saillie; aluminium, noir / plastique, blanc

H 28, Ø 285



19,5W



2700lm



Remote,
App



IP44



98854 FUEVA-Z

surface-mounted light; aluminium, black / plastic, white
Aufbauleuchte; Alu, schwarz / Kunststoff, weiss
luminaire en saillie; aluminium, noir / plastique, blanc

L 285, B 285, H 28



19,5W



2700lm



Remote,
App



IP44



9 008606 225644



Ø 210



9 002759 988470



Ø 285



9 002759 988548



L 285

B 285



900109

LED

900109 FUEVA-Z

surface-mounted light; steel, black / plastic, white
Aufbauleuchte; Stahl, schwarz / Kunststoff, weiss
luminaire en saillie; acier, noir / plastique, blanc

L 210, B 210, H 28



16,5W



2100lm



Remote,
App



IP44

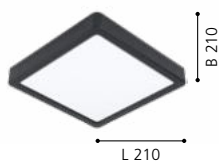

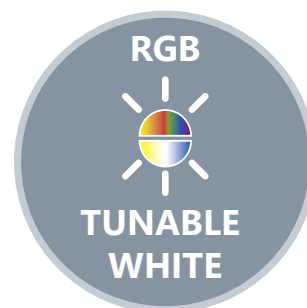

900088 ROVITO-Z

ceiling light; plastic, white / plastic, white
Deckenleuchte; Kunststoff, weiss / Kunststoff, weiss
plafonnier; plastique, blanc / plastique, blanc

L 295, B 295, H 25



900089 ROVITO-Z

ceiling light; plastic, white / plastic, white
Deckenleuchte; Kunststoff, weiss / Kunststoff, weiss
plafonnier; plastique, blanc / plastique, blanc

L 420, B 420, H 25

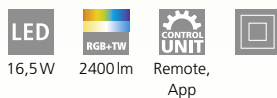

900086 ROVITO-Z

ceiling light; plastic, white / plastic, white
Deckenleuchte; Kunststoff, weiss / Kunststoff, weiss
plafonnier; plastique, blanc / plastique, blanc

H 25, Ø 295





900087

LED

900087 ROVITO-Z

ceiling light; plastic, white / plastic, white

Deckenleuchte; Kunststoff, weiss / Kunststoff, weiss

plafonnier; plastique, blanc / plastique, blanc

H 25, Ø 420

LED

16,5W

RGB+TW

2400lm

CONTROL
UNIT

Remote,
App



Ø 420



900093



900092



900094

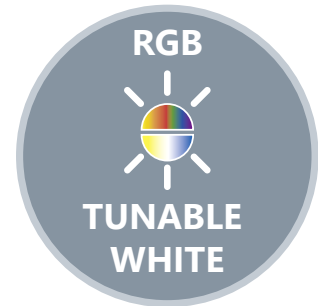

900093 ROVITO-Z

ceiling light; plastic, black / plastic, white
 Deckenleuchte; Kunststoff, schwarz / Kunststoff, weiss
 plafonnier; plastique, noir / plastique, blanc

L 295, B 295, H 25

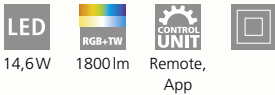

14,6W 1800lm Remote, App

900094 ROVITO-Z

ceiling light; plastic, black / plastic, white
 Deckenleuchte; Kunststoff, schwarz / Kunststoff, weiss
 plafonnier; plastique, noir / plastique, blanc

L 420, B 420, H 25

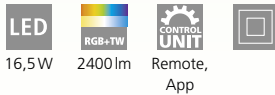

16,5W 2400lm Remote, App

900092 ROVITO-Z

ceiling light; plastic, black / plastic, white
 Deckenleuchte; Kunststoff, schwarz / Kunststoff, weiss
 plafonnier; plastique, noir / plastique, blanc

H 25, Ø 420

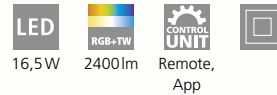

16,5W 2400lm Remote, App



9 008606 225538

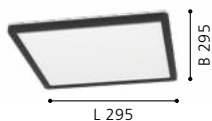

9 008606 225545

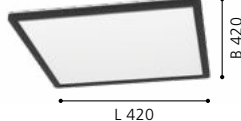

9 008606 225521





900091



900091 ROVITO-Z

ceiling light; plastic, black / plastic, white

Deckenleuchte; Kunststoff, schwarz / Kunststoff, weiss

plafonnier; plastique, noir / plastique, blanc

H 25, Ø 295



14,6W



1800lm



Remote,
App



9 008606 225514

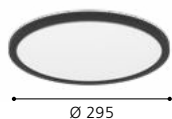



99686

99687

LED



99684

99685

LED



99686, 99687



1x 1,5 m

99686 LED STRIPE-Z

bar / strip light; plastic, white
Leuchtband/-stab; Kunststoff, weiss
bande lumineuse / bâton l; plastique, blanc

L 5000, B 10

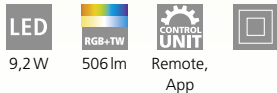

9,2W

506lm

Remote,
App



9 002759 996864



L 5000

99687 LED STRIPE-Z

bar / strip light; plastic, white
Leuchtband/-stab; Kunststoff, weiss
bande lumineuse / bâton l; plastique, blanc

L 8000, B 12, H 3

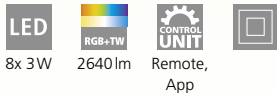

8x 3W

2640lm

Remote,
App



9 002759 996871



L 8000

99684 LED STRIPE-Z

bar / strip light; plastic, white
Leuchtband/-stab; Kunststoff, weiss
bande lumineuse / bâton l; plastique, blanc

L 3000, B 8



13,5W

1350lm

Remote,
App



9 002759 996840



L 3000



99687



99685 LED STRIPE-Z

bar / strip light; plastic, white
 Leuchtband/-stab; Kunststoff, weiss
 bande lumineuse / bâton l; plastique, blanc

L 2000, B 8

			
9W	900lm	Remote, App	

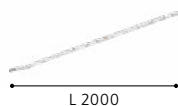

12253 E27-LED-A60

Dimensions Abmessungen / dimensions	L 118, Ø 60
Socket Sockel / douille	E27
Wattage Wattage / puissance	9 W
Light Colour Lichtfarbe / couleur lumineuse	2700-6500K
Operating voltage Betriebsspannung / tension de fonctionnement	220-240V,50/60Hz
Switching cycles Schaltzyklen / cycles de fonctionnement	15.000 x
Operating hours Betriebsstunden / heures de fonctionnement	25.000 h
Colour rendering index Farbwiedergabeindex / L'indice de restitution de couleurs	>80



9W

806 lm
LUMEN

A+ RGB+TW

9W ~ 60W

9 002759 122539

12254 E27-LED-G95

Dimensions Abmessungen / dimensions	L 136, Ø 95
Socket Sockel / douille	E27
Wattage Wattage / puissance	13 W
Light Colour Lichtfarbe / couleur lumineuse	2700-6500K
Operating voltage Betriebsspannung / tension de fonctionnement	220-240V,50/60Hz
Switching cycles Schaltzyklen / cycles de fonctionnement	25.000 x
Operating hours Betriebsstunden / heures de fonctionnement	20.000 h
Colour rendering index Farbwiedergabeindex / L'indice de restitution de couleurs	>80



13W

1300 lm
LUMEN

A+ RGB+TW

13W ~ 88W

9 002759 122546

12252 E14-LED-P45

Dimensions Abmessungen / dimensions	L 90, Ø 45
Socket Sockel / douille	E14
Wattage Wattage / puissance	5 W
Light Colour Lichtfarbe / couleur lumineuse	2700-6500K
Operating voltage Betriebsspannung / tension de fonctionnement	220-240V,50/60Hz
Switching cycles Schaltzyklen / cycles de fonctionnement	25.000 x
Operating hours Betriebsstunden / heures de fonctionnement	20.000 h
Colour rendering index Farbwiedergabeindex / L'indice de restitution de couleurs	>80



5W

470 lm
LUMEN

A+ RGB+TW

5W ~ 40W

9 002759 122522

12251 GU10-LED

Dimensions Abmessungen / dimensions	L 59, Ø 50
Socket Sockel / douille	GU10
Wattage Wattage / puissance	5W
Light Colour Lichtfarbe / couleur lumineuse	2700-6500K
Operating voltage Betriebsspannung / tension de fonctionnement	220-240V,50/60Hz
Switching cycles Schaltzyklen / cycles de fonctionnement	25.000 x
Operating hours Betriebsstunden / heures de fonctionnement	20.000 h
Colour rendering index Farbwiedergabeindex / L'indice de restitution de couleurs	>80
beamangle Ausstrahlwinkel / angle de rayonnement	45°



5W

345 lm
LUMEN



RGB+TW



5W



50W



9 002759 122515



MESH
COLOR

12226 E27-LED-A60

Dimensions Abmessungen / dimensions	L 105, Ø 60
Socket Sockel / douille	E27
Wattage Wattage / puissance	6 W
Light Colour Lichtfarbe / couleur lumineuse	2700K
Operating voltage Betriebsspannung / tension de fonctionnement	220-240V,50/60Hz
Switching cycles Schaltzyklen / cycles de fonctionnement	25.000 x
Operating hours Betriebsstunden / heures de fonctionnement	20.000 h
Colour rendering index Farbwiedergabeindex / L'indice de restitution de couleurs	>80



6W

806 lm
LUMEN

A++ warm WHITE

6W ~ 60W

9 002759 122263

12227 E27-LED-ST64

Dimensions Abmessungen / dimensions	L 142, Ø 64
Socket Sockel / douille	E27
Wattage Wattage / puissance	6 W
Light Colour Lichtfarbe / couleur lumineuse	2700K
Operating voltage Betriebsspannung / tension de fonctionnement	220-240V,50/60Hz
Switching cycles Schaltzyklen / cycles de fonctionnement	25.000 x
Operating hours Betriebsstunden / heures de fonctionnement	20.000 h
Colour rendering index Farbwiedergabeindex / L'indice de restitution de couleurs	>80



6W

806 lm
LUMEN

A++ warm WHITE

6W ~ 60W

9 002759 122270

12228 E27-LED-G80

Dimensions Abmessungen / dimensions	L 120, Ø 80
Socket Sockel / douille	E27
Wattage Wattage / puissance	6 W
Light Colour Lichtfarbe / couleur lumineuse	2700K
Operating voltage Betriebsspannung / tension de fonctionnement	220-240V,50/60Hz
Switching cycles Schaltzyklen / cycles de fonctionnement	25.000 x
Operating hours Betriebsstunden / heures de fonctionnement	20.000 h
Colour rendering index Farbwiedergabeindex / L'indice de restitution de couleurs	>80



6W

806 lm
LUMEN

A++ warm WHITE

6W ~ 60W

9 002759 122287

12229 E27-LED-G95

Dimensions Abmessungen / dimensions	L 140, Ø 95
Socket Sockel / douille	E27
Wattage Wattage / puissance	6 W
Light Colour Lichtfarbe / couleur lumineuse	2700K
Operating voltage Betriebsspannung / tension de fonctionnement	220-240V,50/60Hz
Switching cycles Schaltzyklen / cycles de fonctionnement	25.000 x
Operating hours Betriebsstunden / heures de fonctionnement	20.000 h
Colour rendering index Farbwiedergabeindex / L'indice de restitution de couleurs	>80



6W

806 lm
LUMEN

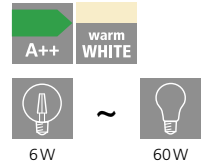

6W

60W



12231 E27-LED-A60

Dimensions Abmessungen / dimensions	L 105, Ø 60
Socket Sockel / douille	E27
Wattage Wattage / puissance	6 W
Light Colour Lichtfarbe / couleur lumineuse	4000K
Operating voltage Betriebsspannung / tension de fonctionnement	220-240V,50/60Hz
Switching cycles Schaltzyklen / cycles de fonctionnement	25.000 x
Operating hours Betriebsstunden / heures de fonctionnement	20.000 h
Colour rendering index Farbwiedergabeindex / L'indice de restitution de couleurs	>80



6W

806 lm
LUMEN

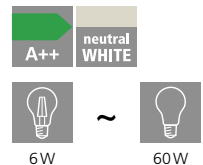

6W

60W



12232 E27-LED-ST64

Dimensions Abmessungen / dimensions	L 142, Ø 64
Socket Sockel / douille	E27
Wattage Wattage / puissance	6 W
Light Colour Lichtfarbe / couleur lumineuse	4000K
Operating voltage Betriebsspannung / tension de fonctionnement	220-240V,50/60Hz
Switching cycles Schaltzyklen / cycles de fonctionnement	25.000 x
Operating hours Betriebsstunden / heures de fonctionnement	20.000 h
Colour rendering index Farbwiedergabeindex / L'indice de restitution de couleurs	>80

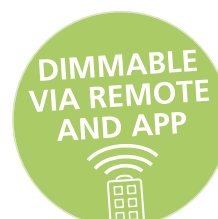

6W

806 lm
LUMEN

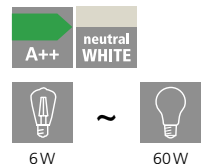

6W

60W



12233 E27-LED-G80

Dimensions Abmessungen / dimensions	L 120, Ø 80
Socket Sockel / douille	E27
Wattage Wattage / puissance	6 W
Light Colour Lichtfarbe / couleur lumineuse	4000K
Operating voltage Betriebsspannung / tension de fonctionnement	220-240V,50/60Hz
Switching cycles Schaltzyklen / cycles de fonctionnement	25.000 x
Operating hours Betriebsstunden / heures de fonctionnement	20.000 h
Colour rendering index Farbwiedergabeindex / L'indice de restitution de couleurs	>80



6W
806 lm
LUMEN

A++ neutral WHITE



12234 E27-LED-G95

Dimensions Abmessungen / dimensions	L 140, Ø 95
Socket Sockel / douille	E27
Wattage Wattage / puissance	6 W
Light Colour Lichtfarbe / couleur lumineuse	4000K
Operating voltage Betriebsspannung / tension de fonctionnement	220-240V,50/60Hz
Switching cycles Schaltzyklen / cycles de fonctionnement	25.000 x
Operating hours Betriebsstunden / heures de fonctionnement	20.000 h
Colour rendering index Farbwiedergabeindex / L'indice de restitution de couleurs	>80



6W
806 lm
LUMEN

A++ neutral WHITE



12235 E27-LED-A60

Dimensions Abmessungen / dimensions	L 105, Ø 60
Socket Sockel / douille	E27
Wattage Wattage / puissance	6 W
Light Colour Lichtfarbe / couleur lumineuse	2200-6500K
Operating voltage Betriebsspannung / tension de fonctionnement	220-240V,50/60Hz
Switching cycles Schaltzyklen / cycles de fonctionnement	25.000 x
Operating hours Betriebsstunden / heures de fonctionnement	20.000 h
Colour rendering index Farbwiedergabeindex / L'indice de restitution de couleurs	>80



6W
806 lm
LUMEN

A++ tunable WHITE



12236 E27-LED-ST64

Dimensions Abmessungen / dimensions	L 142, Ø 64
Socket Sockel / douille	E27
Wattage Wattage / puissance	6W
Light Colour Lichtfarbe / couleur lumineuse	2200-6500K
Operating voltage Betriebsspannung / tension de fonctionnement	220-240V,50/60Hz
Switching cycles Schaltzyklen / cycles de fonctionnement	25.000 x
Operating hours Betriebsstunden / heures de fonctionnement	20.000 h
Colour rendering index Farbwiedergabeindex / L'indice de restitution de couleurs	>80



6W

806 lm
LUMEN



12237 E27-LED-G80

Dimensions Abmessungen / dimensions	L 120, Ø 80
Socket Sockel / douille	E27
Wattage Wattage / puissance	6W
Light Colour Lichtfarbe / couleur lumineuse	2200-6500K
Operating voltage Betriebsspannung / tension de fonctionnement	220-240V,50/60Hz
Switching cycles Schaltzyklen / cycles de fonctionnement	25.000 x
Operating hours Betriebsstunden / heures de fonctionnement	20.000 h
Colour rendering index Farbwiedergabeindex / L'indice de restitution de couleurs	>80



6W

806 lm
LUMEN



12239 E27-LED-G95

Dimensions Abmessungen / dimensions	L 140, Ø 95
Socket Sockel / douille	E27
Wattage Wattage / puissance	6W
Light Colour Lichtfarbe / couleur lumineuse	2200-6500K
Operating voltage Betriebsspannung / tension de fonctionnement	220-240V,50/60Hz
Switching cycles Schaltzyklen / cycles de fonctionnement	25.000 x
Operating hours Betriebsstunden / heures de fonctionnement	20.000 h
Colour rendering index Farbwiedergabeindex / L'indice de restitution de couleurs	>80



6W

806 lm
LUMEN



12221 E27-LED-A60

Dimensions Abmessungen / dimensions	L 105, Ø 60
Socket Sockel / douille	E27
Wattage Wattage / puissance	5,5 W
Light Colour Lichtfarbe / couleur lumineuse	2200K
Operating voltage Betriebsspannung / tension de fonctionnement	220-240V,50/60Hz
Switching cycles Schaltzyklen / cycles de fonctionnement	25.000 x
Operating hours Betriebsstunden / heures de fonctionnement	20.000 h
Colour rendering index Farbwiedergabeindex / L'indice de restitution de couleurs	>80



5,5W

500 lm
LUMEN

A+ warm WHITE

5,5W ~ 41W

9 002759 122218

12222 E27-LED-ST64

Dimensions Abmessungen / dimensions	L 142, Ø 64
Socket Sockel / douille	E27
Wattage Wattage / puissance	5,5 W
Light Colour Lichtfarbe / couleur lumineuse	2200K
Operating voltage Betriebsspannung / tension de fonctionnement	220-240V,50/60Hz
Switching cycles Schaltzyklen / cycles de fonctionnement	25.000 x
Operating hours Betriebsstunden / heures de fonctionnement	20.000 h
Colour rendering index Farbwiedergabeindex / L'indice de restitution de couleurs	>80



5,5W

500 lm
LUMEN

A+ warm WHITE

5,5W ~ 41W

9 002759 122225

12223 E27-LED-G80

Dimensions Abmessungen / dimensions	L 120, Ø 80
Socket Sockel / douille	E27
Wattage Wattage / puissance	5,5 W
Light Colour Lichtfarbe / couleur lumineuse	2200K
Operating voltage Betriebsspannung / tension de fonctionnement	220-240V,50/60Hz
Switching cycles Schaltzyklen / cycles de fonctionnement	15.000 x
Operating hours Betriebsstunden / heures de fonctionnement	20.000 h
Colour rendering index Farbwiedergabeindex / L'indice de restitution de couleurs	>80



5,5W

500 lm
LUMEN

A+ warm WHITE

5,5W ~ 41W

9 002759 122232

12224 E27-LED-G95

Dimensions Abmessungen / dimensions	L 140, Ø 95
Socket Sockel / douille	E27
Wattage Wattage / puissance	5,5W
Light Colour Lichtfarbe / couleur lumineuse	2200K
Operating voltage Betriebsspannung / tension de fonctionnement	220-240V,50/60Hz
Switching cycles Schaltzyklen / cycles de fonctionnement	25.000 x
Operating hours Betriebsstunden / heures de fonctionnement	20.000 h
Colour rendering index Farbwiedergabeindex / L'indice de restitution de couleurs	>80



5,5W

500 lm
LUMEN

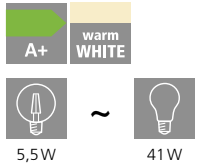

5,5W

41W



9 002759 122249

12225 E27-LED-G125

Dimensions Abmessungen / dimensions	L 172, Ø 125
Socket Sockel / douille	E27
Wattage Wattage / puissance	6W
Light Colour Lichtfarbe / couleur lumineuse	2200K
Operating voltage Betriebsspannung / tension de fonctionnement	220-240V,50/60Hz
Switching cycles Schaltzyklen / cycles de fonctionnement	25.000 x
Operating hours Betriebsstunden / heures de fonctionnement	20.000 h
Colour rendering index Farbwiedergabeindex / L'indice de restitution de couleurs	>80



6W

650 lm
LUMEN

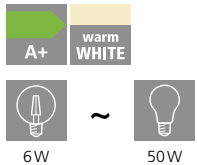

6W

50W



9 002759 122256

12241 E27-LED-A60

Dimensions Abmessungen / dimensions	L 105, Ø 60
Socket Sockel / douille	E27
Wattage Wattage / puissance	5,5 W
Light Colour Lichtfarbe / couleur lumineuse	2200-6500K
Operating voltage Betriebsspannung / tension de fonctionnement	220-240V,50/60Hz
Switching cycles Schaltzyklen / cycles de fonctionnement	25.000 x
Operating hours Betriebsstunden / heures de fonctionnement	20.000 h
Colour rendering index Farbwiedergabeindex / L'indice de restitution de couleurs	>80



5,5W

400 lm
LUMEN

A+ tunable WHITE

5,5W ~ 35W

9 002759 122416

12242 E27-LED-ST64

Dimensions Abmessungen / dimensions	L 142, Ø 64
Socket Sockel / douille	E27
Wattage Wattage / puissance	5,5 W
Light Colour Lichtfarbe / couleur lumineuse	2200-6500K
Operating voltage Betriebsspannung / tension de fonctionnement	220-240V,50/60Hz
Switching cycles Schaltzyklen / cycles de fonctionnement	25.000 x
Operating hours Betriebsstunden / heures de fonctionnement	20.000 h
Colour rendering index Farbwiedergabeindex / L'indice de restitution de couleurs	>80



5,5W

400 lm
LUMEN

A+ tunable WHITE

5,5W ~ 35W

9 002759 122423

12243 E27-LED-G80

Dimensions Abmessungen / dimensions	L 120, Ø 80
Socket Sockel / douille	E27
Wattage Wattage / puissance	5,5 W
Light Colour Lichtfarbe / couleur lumineuse	2200-6500K
Operating voltage Betriebsspannung / tension de fonctionnement	220-240V,50/60Hz
Switching cycles Schaltzyklen / cycles de fonctionnement	25.000 x
Operating hours Betriebsstunden / heures de fonctionnement	20.000 h
Colour rendering index Farbwiedergabeindex / L'indice de restitution de couleurs	>80



5,5W

400 lm
LUMEN

A+ tunable WHITE

5,5W ~ 35W

9 002759 122430

12244 E27-LED-G95

Dimensions Abmessungen / dimensions	L 140, Ø 95
Socket Sockel / douille	E27
Wattage Wattage / puissance	5,5W
Light Colour Lichtfarbe / couleur lumineuse	2200-6500K
Operating voltage Betriebsspannung / tension de fonctionnement	220-240V,50/60Hz
Switching cycles Schaltzyklen / cycles de fonctionnement	25.000 x
Operating hours Betriebsstunden / heures de fonctionnement	20.000 h
Colour rendering index Farbwiedergabeindex / L'indice de restitution de couleurs	>80



5,5W

400 lm
LUMEN



12245 E27-LED-G125

Dimensions Abmessungen / dimensions	L 172, Ø 125
Socket Sockel / douille	E27
Wattage Wattage / puissance	5,5W
Light Colour Lichtfarbe / couleur lumineuse	2200-6500K
Operating voltage Betriebsspannung / tension de fonctionnement	220-240V,50/60Hz
Switching cycles Schaltzyklen / cycles de fonctionnement	25.000 x
Operating hours Betriebsstunden / heures de fonctionnement	20.000 h
Colour rendering index Farbwiedergabeindex / L'indice de restitution de couleurs	>80



5,5W

400 lm
LUMEN



12255 E27-LED-A60

Dimensions Abmessungen / dimensions	L 105, Ø 60
Socket Sockel / douille	E27
Wattage Wattage / puissance	6 W
Light Colour Lichtfarbe / couleur lumineuse	4000K
Operating voltage Betriebsspannung / tension de fonctionnement	220-240V,50/60Hz
Switching cycles Schaltzyklen / cycles de fonctionnement	25.000 x
Operating hours Betriebsstunden / heures de fonctionnement	20.000 h
Colour rendering index Farbwiedergabeindex / L'indice de restitution de couleurs	>80



incl./inkl./inclus



6W
806 lm
LUMEN

A++ neutral WHITE



12256 E27-LED-ST64

Dimensions Abmessungen / dimensions	L 142, Ø 64
Socket Sockel / douille	E27
Wattage Wattage / puissance	5,5 W
Light Colour Lichtfarbe / couleur lumineuse	2200K
Operating voltage Betriebsspannung / tension de fonctionnement	220-240V,50/60Hz
Switching cycles Schaltzyklen / cycles de fonctionnement	25.000 x
Operating hours Betriebsstunden / heures de fonctionnement	20.000 h
Colour rendering index Farbwiedergabeindex / L'indice de restitution de couleurs	>80



incl./inkl./inclus



5,5W
500 lm
LUMEN

A+ warm WHITE



12257 E27-LED-A60

Dimensions Abmessungen / dimensions	L 105, Ø 60
Socket Sockel / douille	E27
Wattage Wattage / puissance	6 W
Light Colour Lichtfarbe / couleur lumineuse	4000K
Operating voltage Betriebsspannung / tension de fonctionnement	220-240V,50/60Hz
Switching cycles Schaltzyklen / cycles de fonctionnement	25.000 x
Operating hours Betriebsstunden / heures de fonctionnement	20.000 h
Colour rendering index Farbwiedergabeindex / L'indice de restitution de couleurs	>80



incl./inkl./inclus

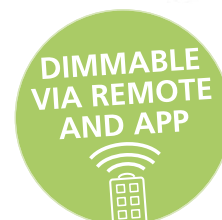

6W
806 lm
LUMEN

A++ neutral WHITE



12258 E27-LED-ST64

Dimensions Abmessungen / dimensions	L 142, Ø 64
Socket Sockel / douille	E27
Wattage Wattage / puissance	5,5W
Light Colour Lichtfarbe / couleur lumineuse	2200K
Operating voltage Betriebsspannung / tension de fonctionnement	220-240V,50/60Hz
Switching cycles Schaltzyklen / cycles de fonctionnement	25.000 x
Operating hours Betriebsstunden / heures de fonctionnement	20.000 h
Colour rendering index Farbwiedergabeindex / L'indice de restitution de couleurs	>80



incl./inkl./inclus

5,5W

500 lm
LUMEN

A+

warm
WHITE



5,5W



41W

DIMMABLE
VIA REMOTE
AND APP



9 002759 122584







































EGLO Access

Let **light** follow
your **life**



OVERVIEW

EGLO ACCESS

							
ACCESS REMOTE p. 82	ZUBIETA-A p. 82	ZUBIETA-A p. 82	ZUBIETA-A p. 83	ZUBIETA-A p. 84	ZUBIETA-A p. 84	ZUBIETA-A p. 84	SILERAS-A p. 85
							
SILERAS-A p. 85	FRANIA-A p. 86	FRANIA-A p. 86	FRANIA-A p. 86	FRANIA-A p. 87	MORATICA-A p. 87	MORATICA-A p. 87	SARSINA-A p. 88
							
SARSINA-A p. 88	SARSINA-A p. 88	SALOBRENA-A p. 90	SALOBRENA-A p. 90	SALOBRENA-A p. 90	SALOBRENA-A p. 91	SALOBRENA-A p. 91	FUEVA-A p. 92
							
FUEVA-A p. 92	FUEVA-A p. 92	LED-STRIPE-A p. 94	LED-STRIPE-A p. 94	LM_LED_E14 p. 96	LM_LED_E14 p. 96	LM_LED_E27 p. 96	LM_LED_E27 p. 97
							
LM_LED_E27 p. 98	LM_LED_GU10 p. 98	LM_LED_E27 p. 98	LM_LED_GU10 p. 99				

FUNCTIONS

FUNKTIONEN
FONCTIONS

Relax with warm light and leave the hustle and bustle of everyday life behind you. Concentrate on your work or dispel fatigue, with neutral white light the energy level is replenished. EGLO Access offers these possibilities and many more. All functions and highlights at a glance:

- › It works with radio frequency technology and allows 360 degree control
- › Controllable up to a distance of 10 meters
- › Up to 8 different items can be connected
- › Easy handling thanks to 4 ready-made settings and 2 memory functions

NIGHT LIGHT

RELAX MODE

WORK MODE

SWITCH OFF AFTER 30 MINUTES

Mit warmem Licht entspannen und die Hektik des Alltages hinter sich lassen. Konzentriert arbeiten oder die Müdigkeit vertreiben, mit neutralweißem Licht wird das Energielevel wieder aufgefüllt. Diese Möglichkeiten und noch viele mehr bietet Ihnen EGLO Access. Alle Funktionen und Highlights auf einem Blick:

- › Es arbeitet mit Funktechnologie und ermöglicht eine 360-Grad-Steuerung
- › Steuerbar bis zu einer Entfernung von 10 Metern
- › Bis zu 8 verschiedene Artikel können miteinander verbunden werden
- › Einfache Handhabung durch 4 vorgefertigte Einstellungen und 2 Speicherfunktionen

NACHTLICHT

ENTSPANNUNGSMODUS

ARBEITSMODUS

AUSSCHALTEN NACH 30 MINUTEN

Lumière chaude pour se détendre et laisser l'agitation quotidienne derrière soi. Travailler de manière concentrée ou chasser la fatigue, avec une lumière blanche neutre, le niveau d'énergie est rétabli. EGLO Access vous offre ces possibilités et bien d'autres encore. Toutes les fonctions et les points forts en un coup d'œil :

- › Il fonctionne avec la technologie de la fréquence radio et permet un contrôle à 360 degrés
- › Contrôlable jusqu'à une distance de 10 mètres
- › Jusqu'à 8 articles différents peuvent être connectés ensemble
- › Manipulation facile grâce à 4 réglages prêts à l'emploi et 2 fonctions mémoire

VEILLEUSE

MODE DE DÉCOMPRESSION

MODE DE TRAVAIL

EXTINCTION APRÈS 30 MINUTES

COLOUR TEMPERATURES SCALE / FARBTEMPERATUREN SKALA / ÉCHELLE DES TEMPÉRATURES DE COULEUR



REMOTE CONTROL

FERNBEDIENUNG
TÉLÉCOMMANDE

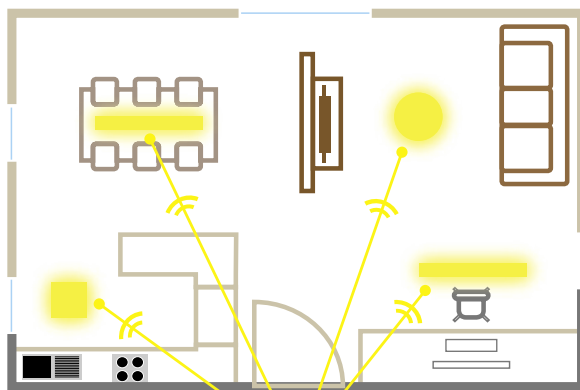

no internet necessary
kein Internet erforderlich
nul besoin d'internet



Control up to 8 EGLO Access luminaires
Bis zu 8 EGLO Access Leuchten steuerbar
Contrôle jusqu'à 8 luminaires EGLO Access

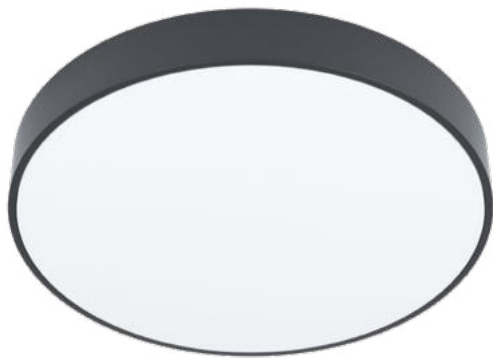

98894

LED

incl./inkl./inclus



33199



incl./inkl./inclus

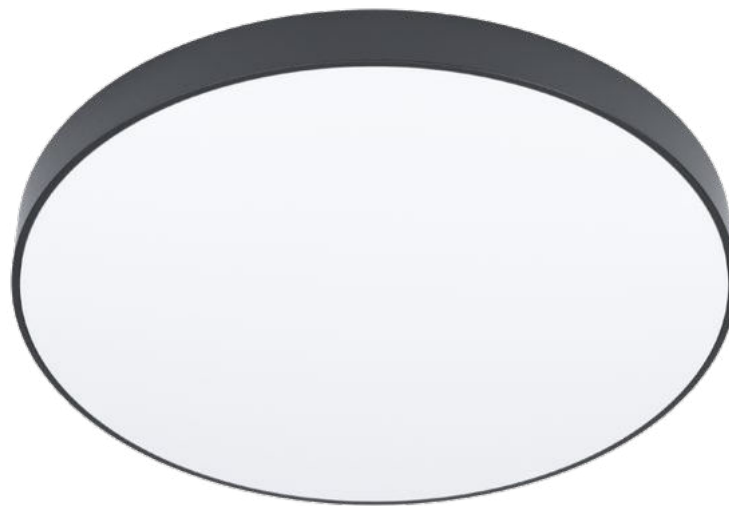

98895

LED

incl./inkl./inclus



33199 ACCESS REMOTE

remote control; plastic, anthracite
Fernbedienung; Kunststoff, anthrazit
Télécommande; plastique, anthracite

L 118, B 45



ACCU
CR2032

98894 ZUBIETA-A

surface-mounted light; steel, black / plastic, white
Aufbauleuchte; Stahl, schwarz / Kunststoff, weiss
luminaire en saillie; acier, noir / plastique, blanc

H 40, Ø 300



18W



tunable
WHITE
1900lm



remote



CONTROL
UNIT
remote

98895 ZUBIETA-A

surface-mounted light; steel, black / plastic, white
Aufbauleuchte; Stahl, schwarz / Kunststoff, weiss
luminaire en saillie; acier, noir / plastique, blanc

H 40, Ø 450



24W



tunable
WHITE
2300lm



remote



CONTROL
UNIT
remote



9 002759 331993



9 002759 988944

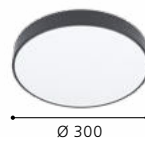

9 002759 988951

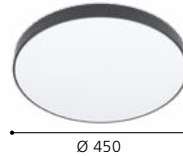



98896

LED

incl./inkl./inclus



98896 ZUBIETA-A

surface-mounted light; steel, black / plastic, white
Aufbauleuchte; Stahl, schwarz / Kunststoff, weiss
luminaire en saillie; acier, noir / plastique, blanc

H 40, Ø 595



36W



3700lm



remote



9 002759 988968



Ø 595

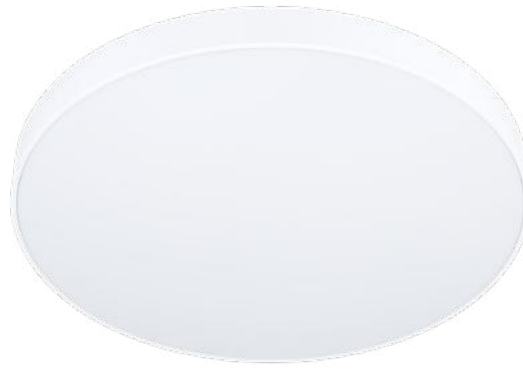

98892



98891



98893



98891 ZUBIETA-A

surface-mounted light; steel, white / plastic, white
Aufbauleuchte; Stahl, weiss / Kunststoff, weiss
luminaire en saillie; acier, blanc / plastique, blanc

H 40, Ø 300



18W



1900lm



remote

98892 ZUBIETA-A

surface-mounted light; steel, white / plastic, white
Aufbauleuchte; Stahl, weiss / Kunststoff, weiss
luminaire en saillie; acier, blanc / plastique, blanc

H 40, Ø 450



24W



2300lm



remote

98893 ZUBIETA-A

surface-mounted light; steel, white / plastic, white
Aufbauleuchte; Stahl, weiss / Kunststoff, weiss
luminaire en saillie; acier, blanc / plastique, blanc

H 40, Ø 595



36W



3700lm



remote



9 002759 988913



Ø 300



9 002759 988920



Ø 450



9 002759 988937



Ø 595





98227



98228



98227 SILERAS-A

wall / ceiling light; steel, white / plastic with crystal effect, white
Wand- / Deckenleuchte; Stahl, weiss / Kunststoff m.Kristalleffekt, weiss
applique / plafonnier; acier, blanc / plastique avec effet cristal, blanc

H 80, Ø 450



98228 SILERAS-A

wall / ceiling light; steel, white / plastic with crystal effect, white
Wand- / Deckenleuchte; Stahl, weiss / Kunststoff m.Kristalleffekt, weiss
applique / plafonnier; acier, blanc / plastique avec effet cristal, blanc

H 85, Ø 600

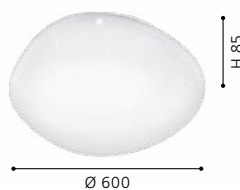



98236



incl./inkl./inclus



98294



incl./inkl./inclus



98237



incl./inkl./inclus

98294 FRANIA-A

wall / ceiling light; steel, white / plastic with crystal effect, white
Wand- / Deckenleuchte; Stahl, weiss / Kunststoff m.Kristalleffekt, weiss
applique / plafonnier; acier, blanc / plastique avec effet cristal, blanc

H 55, Ø 300



12W



1050lm



remote



IP44

98236 FRANIA-A

wall / ceiling light; steel, white / plastic with crystal effect, white
Wand- / Deckenleuchte; Stahl, weiss / Kunststoff m.Kristalleffekt, weiss
applique / plafonnier; acier, blanc / plastique avec effet cristal, blanc

H 55, Ø 400



24W



1800lm



remote

98237 FRANIA-A

wall / ceiling light; steel, white / plastic with crystal effect, white
Wand- / Deckenleuchte; Stahl, weiss / Kunststoff m.Kristalleffekt, weiss
applique / plafonnier; acier, blanc / plastique avec effet cristal, blanc

H 75, Ø 570



36W



3300lm



remote



9 002759 982942



H 55

Ø 300



9 002759 982362



H 55

Ø 400



9 002759 982379



H 75

Ø 570



98219



incl./inkl./inclus



98235



incl./inkl./inclus



98223



incl./inkl./inclus

98235 FRANIA-A

wall / ceiling light; steel, white / plastic, white
Wand- / Deckenleuchte; Stahl, weiss / Kunststoff, weiss
applique / plafonnier; acier, blanc / plastique, blanc

H 55, Ø 300



12W



1050lm



remote



9 002759 982355

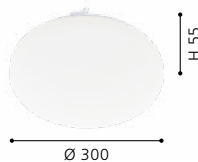

Ø 300

98219 MORATICA-A

ceiling light; steel, plastic, white, transparent / plastic with
crystal effect, white, silver
Deckenleuchte; Stahl, Kunststoff, weiss, transparent / Kunststoff
m.Kristalleffekt, weiss, silber
plafonnier; acier, plastique, blanc, transparent / plastique avec
effet cristal, blanc, argent
H 75, Ø 570



36W



3300lm



remote



9 002759 982195



Ø 570

98223 MORATICA-A

ceiling light; steel, plastic, white, transparent / plastic with
crystal effect, white, silver
Deckenleuchte; Stahl, Kunststoff, weiss, transparent / Kunststoff
m.Kristalleffekt, weiss, silber
plafonnier; acier, plastique, blanc, transparent / plastique avec
effet cristal, blanc, argent
H 85, Ø 760



60W



5900lm



remote



9 002759 982232



Ø 760



98207



incl./inkl./inclus



98208



incl./inkl./inclus

98207 SARSINA-A

ceiling light; aluminium, white / plastic, white
Deckenleuchte; Alu, weiss / Kunststoff, weiss
plafonnier; aluminium, blanc / plastique, blanc

H 50, Ø 300



14W



2000lm



remote



98208 SARSINA-A

ceiling light; aluminium, white / plastic, white
Deckenleuchte; Alu, weiss / Kunststoff, weiss
plafonnier; aluminium, blanc / plastique, blanc

H 50, Ø 450



19,5W



2750lm



remote



98209 SARSINA-A

ceiling light; aluminium, white / plastic, white
Deckenleuchte; Alu, weiss / Kunststoff, weiss
plafonnier; aluminium, blanc / plastique, blanc

H 50, Ø 600



30W



4000lm



remote



9 002759 982072



9 002759 982089



9 002759 982096





98209

LED

incl./inkl./inclus





98205



incl./inkl./inclus



98206



incl./inkl./inclus



98297



incl./inkl./inclus

98205 SALOBRENA-A

ceiling light; aluminium, white / plastic, white
Deckenleuchte; Alu, weiss / Kunststoff, weiss
plafonnier; aluminium, blanc / plastique, blanc

L 1200, B 300, H 50



30W

3900lm

remote

98206 SALOBRENA-A

ceiling light; aluminium, white / plastic, white
Deckenleuchte; Alu, weiss / Kunststoff, weiss
plafonnier; aluminium, blanc / plastique, blanc

L 1195, B 100, H 50



30W

3900lm

remote

98297 SALOBRENA-A

ceiling light; aluminium, white / plastic, white
Deckenleuchte; Alu, weiss / Kunststoff, weiss
plafonnier; aluminium, blanc / plastique, blanc

L 450, B 450, H 50



20W

2600lm

remote



9 002759 982058



9 002759 982065

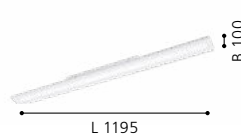

9 002759 982973

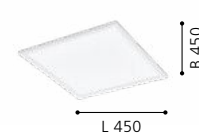



98201



incl./inkl./inclus



98203



incl./inkl./inclus



98201 SALOBRENA-A

ceiling light; aluminium, white / plastic, white
Deckenleuchte; Alu, weiss / Kunststoff, weiss
plafonnier; aluminium, blanc / plastique, blanc

L 300, B 300, H 50



14W

1850lm

remote

98203 SALOBRENA-A

ceiling light; aluminium, white / plastic, white
Deckenleuchte; Alu, weiss / Kunststoff, weiss
plafonnier; aluminium, blanc / plastique, blanc

L 600, B 600, H 50



30W

4000lm

remote



9 002759 982010



9 002759 982034

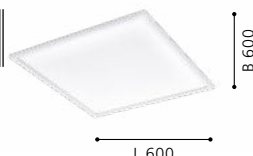



98292



98293



FUEVA-A

These luminaires inspire with their extremely flat and elegant design.

Diese Leuchten begeistern durch ihre extrem flache und elegante Bauweise.

Ces lumières enthousiasment par la méthode de construction extrêmement plate et élégante.

98292 FUEVA-A

surface-mounted light; aluminium, white / plastic, white
 Aufbauleuchte; Alu, weiss / Kunststoff, weiss
 luminaire en saillie; aluminium, blanc / plastique, blanc

H 30, Ø 225



98293 FUEVA-A

surface-mounted light; aluminium, white / plastic, white
 Aufbauleuchte; Alu, weiss / Kunststoff, weiss
 luminaire en saillie; aluminium, blanc / plastique, blanc

H 30, Ø 300



98212 FUEVA-A

recessed light; aluminium, white / plastic, white
 Einbauleuchte; Alu, weiss / Kunststoff, weiss
 luminaire encastrable; aluminium, blanc / plastique, blanc

Ø 120, ET 30

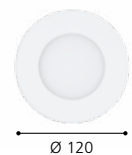



98212

LED

incl./inkl./inclus





98295



98296



98295, 98296

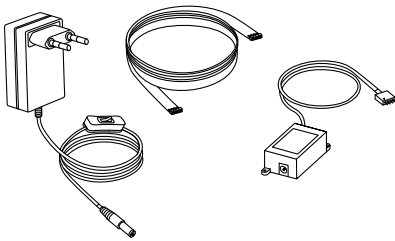

98295, 98296

These articles include a remote control.

Bei diesen Artikeln ist eine Fernbedienung inkludiert.

Ces articles comprennent une télécommande.



98295 LED-STRIPE-A

bar / strip light; plastic, white
 Leuchtband/-stab; Kunststoff, weiss
 bande lumineuse / bâton l; plastique, blanc

L 2000, B 10, H 3



98296 LED-STRIPE-A

bar / strip light; plastic, white
 Leuchtband/-stab; Kunststoff, weiss
 bande lumineuse / bâton l; plastique, blanc

L 5000, B 10, H 3

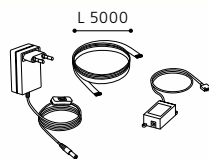
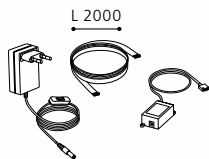



98296

LED

11804 E14-LED-P45

Dimensions Abmessungen / dimensions	L 90, Ø 45
Socket Sockel / douille	E14
Wattage Wattage / puissance	5 W
Light Colour Lichtfarbe / couleur lumineuse	2700-6500K
Operating voltage Betriebsspannung / tension de fonctionnement	220-240V,50/60Hz
Switching cycles Schaltzyklen / cycles de fonctionnement	15.000 x
Operating hours Betriebsstunden / heures de fonctionnement	25.000 h
Colour rendering index Farbwiedergabeindex / L'indice de restitution de couleurs	>80



5W

400 lm
LUMEN

A+ tunable WHITE

5W ~ 35W

9 002759 118044

11805 E14-LED-P45

Dimensions Abmessungen / dimensions	L 90, Ø 45
Socket Sockel / douille	E14
Wattage Wattage / puissance	5 W
Light Colour Lichtfarbe / couleur lumineuse	2700-6500K
Operating voltage Betriebsspannung / tension de fonctionnement	220-240V,50/60Hz
Switching cycles Schaltzyklen / cycles de fonctionnement	15.000 x
Operating hours Betriebsstunden / heures de fonctionnement	25.000 h
Colour rendering index Farbwiedergabeindex / L'indice de restitution de couleurs	>80



5W

400 lm
LUMEN

A+ tunable WHITE

5W ~ 35W

incl./inkl./inclus

9 002759 118051

11806 E27-LED-A60

Dimensions Abmessungen / dimensions	L 118, Ø 60
Socket Sockel / douille	E27
Wattage Wattage / puissance	9 W
Light Colour Lichtfarbe / couleur lumineuse	2700-6500K
Operating voltage Betriebsspannung / tension de fonctionnement	220-240V,50/60Hz
Switching cycles Schaltzyklen / cycles de fonctionnement	15.000 x
Operating hours Betriebsstunden / heures de fonctionnement	25.000 h
Colour rendering index Farbwiedergabeindex / L'indice de restitution de couleurs	>80



9W

806 lm
LUMEN

A+ tunable WHITE

9W ~ 60W

9 002759 118068

11807 E27-LED-A60

Dimensions Abmessungen / dimensions	L 118, Ø 60
Socket Sockel / douille	E27
Wattage Wattage / puissance	9W
Light Colour Lichtfarbe / couleur lumineuse	2700-6500K
Operating voltage Betriebsspannung / tension de fonctionnement	220-240V,50/60Hz
Switching cycles Schaltzyklen / cycles de fonctionnement	15.000 x
Operating hours Betriebsstunden / heures de fonctionnement	25.000 h
Colour rendering index Farbwiedergabeindex / L'indice de restitution de couleurs	>80



11809 E27-LED-G95

Dimensions Abmessungen / dimensions	L 140, Ø 95
Socket Sockel / douille	E27
Wattage Wattage / puissance	12 W
Light Colour Lichtfarbe / couleur lumineuse	2700-6500K
Operating voltage Betriebsspannung / tension de fonctionnement	220-240V,50/60Hz
Switching cycles Schaltzyklen / cycles de fonctionnement	15.000 x
Operating hours Betriebsstunden / heures de fonctionnement	25.000 h
Colour rendering index Farbwiedergabeindex / L'indice de restitution de couleurs	>80



11811 E27-LED-G95

Dimensions Abmessungen / dimensions	L 140, Ø 95
Socket Sockel / douille	E27
Wattage Wattage / puissance	12 W
Light Colour Lichtfarbe / couleur lumineuse	2700-6500K
Operating voltage Betriebsspannung / tension de fonctionnement	220-240V,50/60Hz
Switching cycles Schaltzyklen / cycles de fonctionnement	100.000 x
Operating hours Betriebsstunden / heures de fonctionnement	25.000 h
Colour rendering index Farbwiedergabeindex / L'indice de restitution de couleurs	>80



11802 GU10-LED

Dimensions Abmessungen / dimensions	L 56, Ø 50
Socket Sockel / douille	GU10
Wattage Wattage / puissance	5 W
Light Colour Lichtfarbe / couleur lumineuse	2700-6500K
Operating voltage Betriebsspannung / tension de fonctionnement	220-240V,50/60Hz
Switching cycles Schaltzyklen / cycles de fonctionnement	15.000 x
Operating hours Betriebsstunden / heures de fonctionnement	25.000 h
Colour rendering index Farbwiedergabeindex / L'indice de restitution de couleurs	>80



11801 GU10-LED

Dimensions Abmessungen / dimensions	L 56, Ø 50
Socket Sockel / douille	GU10
Wattage Wattage / puissance	5W
Light Colour Lichtfarbe / couleur lumineuse	2700-6500K
Operating voltage Betriebsspannung / tension de fonctionnement	220-240V,50/60Hz
Switching cycles Schaltzyklen / cycles de fonctionnement	15.000 x
Operating hours Betriebsstunden / heures de fonctionnement	25.000 h
Colour rendering index Farbwiedergabeindex / L'indice de restitution de couleurs	>80



5W

315 lm
LUMEN



LIGHTING FAMILIES

FABRIC LUMINAIRES

STOFFLEUCHTEN

LUMINAIRES À TEXTIL

SIMPLE CLASSINESS -

The textile luminaires with their unusual designs are perfectly trendy and bring cosiness to every home. Selected textiles in natural shades and clear shapes form the basis of a friendly and tasteful living environment in our textile luminaires. Inner coatings in sophisticated gold and classical silver add an air of luxury.



SCHLICHTE ELEGANZ -

Die Stoffleuchten mit ihrem außergewöhnlichen Design sind voll im Trend und sorgen für Gemütlichkeit in jedem Zuhause. Bei den Stoffleuchten bilden ausgesuchte Stoffe in Naturtönen und klare Formgebungen die Grundlage für eine freundliche und geschmackvolle Wohnumgebung. Für einen Hauch von Luxus sorgen die Innenbeschichtungen in edlem Gold und klassischem Silber.



ÉLÉGANCE SIMPLE -

Les luminaires en étoffe avec leur design extraordinaire sont très tendance et assurent un confort dans chaque maison. Chez les luminaires en étoffe, des étoffes sélectionnées dans des tons naturels et des formes claires forment la base d'un cadre de vie convivial et de bon goût. Les revêtements internes en or fin et en argent classique ajoutent une touche de luxe.



OVERVIEW

LIGHTING FAMILIES / FABRIC

							
ROMAO 1 p. 106	ROMAO p. 106 - 107	ROMAO 3 p. 107	PASTERI p. 108 - 111, 116 - 131	POSADERRA p. 112 - 114	PASTERI SQUARE p. 112 - 114	VISERBELLA p. 132 - 134	ESTEPERRA p. 136 - 139
							
VARILLAS p. 140 - 141	MARASALES p. 142 - 144	MASERLO p. 146, 152 - 161	MASERLO 2 p. 146, 154, 157	MASERLO 1 p. 149 - 150	CONCESSA 1 p. 162 - 163	ALBARIZA p. 164	ALMEIDA 2 p. 166 - 167
							
ALMEIDA 1 p. 168	ALMEIDA p. 169	TOMBOLO p. 170	MARONDA p. 170				



This product is available in different colors and shapes./ Dieser Artikel ist in unterschiedlichen Farben und Formen verfügbar.
Cet article est disponible en différentes couleurs et formes.



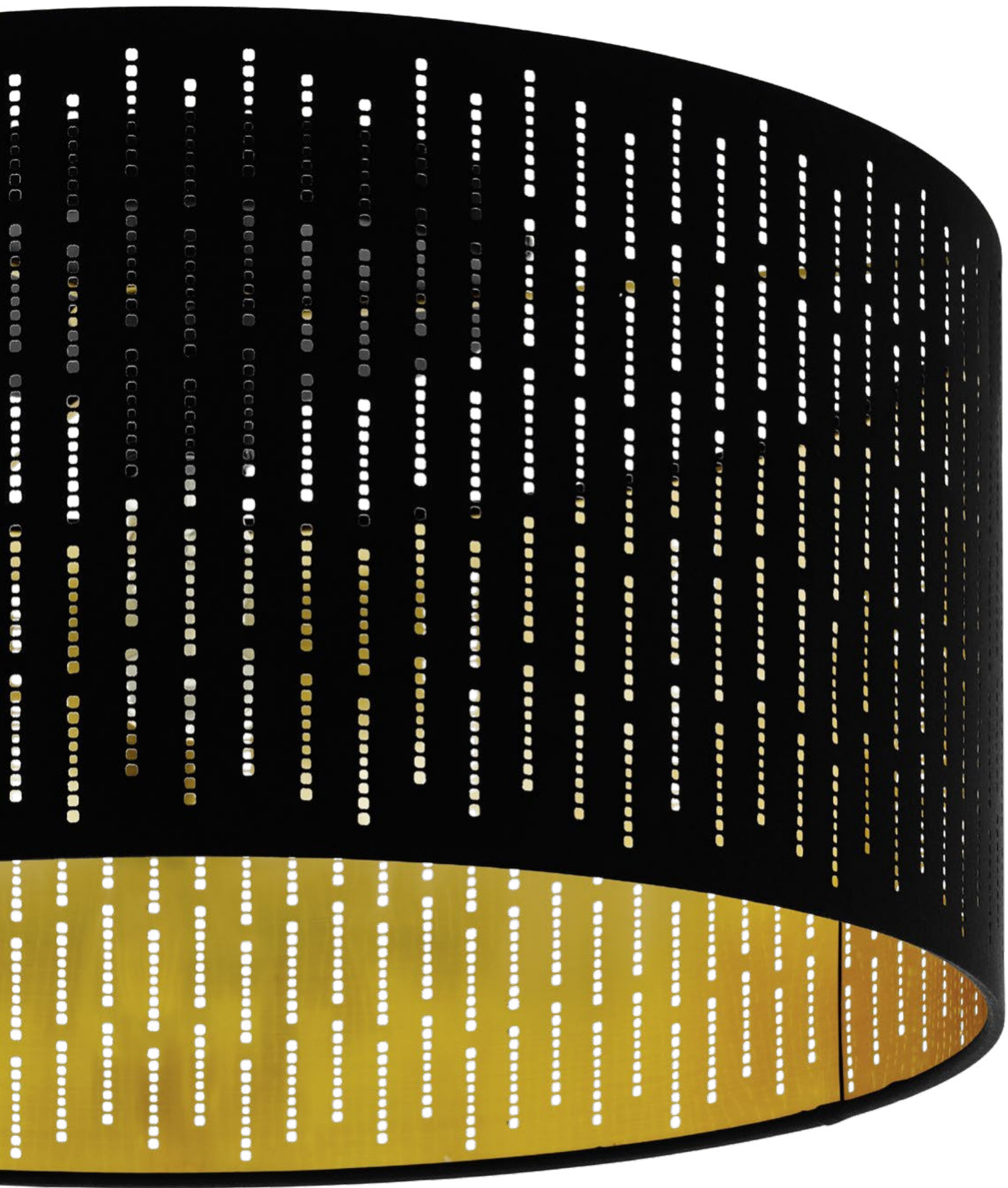

FABRIC MATERIALS

COATING



coating, silver
Beschichtung, silber
revêtement, argent



coating, gold
Beschichtung, gold
revêtement, or

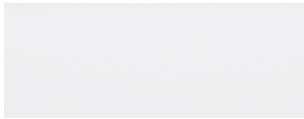

coating, white
Beschichtung, weiß
revêtement, blanc



coating, copper
Beschichtung, kupfer
revêtement, cuivre



coating, black
Beschichtung, schwarz
revêtement, noir



coating, brass
Beschichtung, messing
revêtement, laiton

SHADES

GLOSSY

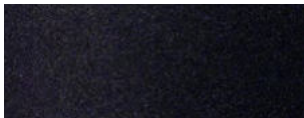

fabric, glossy black
Textil, samtglänzend schwarz
tissu, velours noir brillant



fabric, glossy taupe
Textil, samtglänzend taupe
tissu, velours taupe brillant

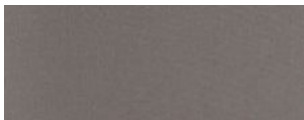

fabric, glossy cappuccino
Textil, samtglänzend cappuccino
tissu, velours cappuccino brillant

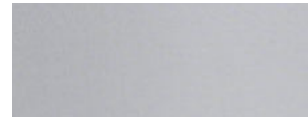

fabric, glossy grey
Textil, samtglänzend grau
tissu, velours gris brillant

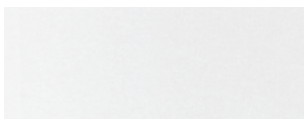

fabric, glossy white
Textil, samtglänzend weiss
tissu, velours blanc brillant



fabric, glossy gold
Textil, samtglänzend gold
tissu, velours or brillant

MAT



fabric, mat black
Textil, matt schwarz
tissu, tapis noir

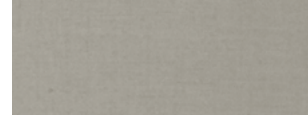

fabric, mat taupe
Textil, matt taupe
tissu, tapis taupe



fabric, mat anthracite-brown
Textil, matt anthrazit-braun
tissu, tapis anthracite-marron



fabric, mat grey
Textil, matt grau
tissu, tapis gris

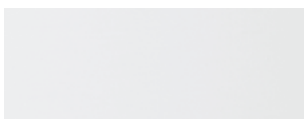

fabric, mat white
Textil, matt weiss
tissu, tapis blanc

LINEN



linen, grey
Leinen, grau
lin, gris



linen, brown
Leinen, braun
lin, marron



97777 ROMAO 1

ceiling light; steel, white / fabric, plastic, white
Deckenleuchte; Stahl, weiss / Textil, Kunststoff, weiss
plafonnier; acier, blanc / tissu, plastique, blanc

H 120, Ø 570



97782 ROMAO 1

ceiling light; steel, white / fabric, plastic, white
Deckenleuchte; Stahl, weiss / Textil, Kunststoff, weiss
plafonnier; acier, blanc / tissu, plastique, blanc

H 120, Ø 760



97779 ROMAO

ceiling light; steel, white / fabric linen, plastic, grey, white
Deckenleuchte; Stahl, weiss / Textil Leinen, Kunststoff, grau, weiss
plafonnier; acier, blanc / tissu de lin, plastique, gris, blanc

H 120, Ø 570





97784



incl./inkl./inclus



97783



incl./inkl./inclus



97778



incl./inkl./inclus



TUNABLE WHITE 3000 - 5000 K	DIMMABLE 10 - 100 %	TIMER FUNCTION off after 30sec.	NIGHT LIGHT FUNCTION	<u>97777</u>	<u>97782</u>
				<u>97778</u>	<u>97783</u>
				<u>97779</u>	<u>97784</u>

see page / siehe Seite / voir la page 416

97784 ROMAO

ceiling light; steel, white / fabric linen, plastic, grey, white
Deckenleuchte; Stahl, weiss / Textil Leinen, Kunststoff, grau, weiss
plafonnier; acier, blanc / tissu de lin, plastique, gris, blanc

H 120, Ø 760



60W

5800lm

remote

97778 ROMAO 3

ceiling light; steel, white / fabric, plastic, taupe, white
Deckenleuchte; Stahl, weiss / Textil, Kunststoff, taupe, weiss
plafonnier; acier, blanc / tissu, plastique, taupe, blanc

H 120, Ø 570



40W

4000lm

remote

97783 ROMAO 3

ceiling light; steel, white / fabric, plastic, taupe, white
Deckenleuchte; Stahl, weiss / Textil, Kunststoff, taupe, weiss
plafonnier; acier, blanc / tissu, plastique, taupe, blanc

H 120, Ø 760



60W

5800lm

remote



9 002759 977849



9 002759 977788



9 002759 977832





97611 PASTERI

ceiling light; steel, white / fabric, white
Deckenleuchte; Stahl, weiss / Textil, weiss
plafonnier; acier, blanc / tissu, blanc

H 150, Ø 570



E27



3x 25W

97615 PASTERI

ceiling light; steel, white / fabric, white
Deckenleuchte; Stahl, weiss / Textil, weiss
plafonnier; acier, blanc / tissu, blanc

H 150, Ø 760



E27



5x 25W

97619 PASTERI

ceiling light; steel, white / fabric, white
Deckenleuchte; Stahl, weiss / Textil, weiss
plafonnier; acier, blanc / tissu, blanc

H 170, Ø 980



E27



7x 25W





97613 PASTERI

ceiling light; steel, white / fabric, linen, grey, white
Deckenleuchte; Stahl, weiss / Textil, Leinen, grau, weiss
plafonnier; acier, blanc / tissu, lin, gris, blanc

H 150, Ø 570



9 002759 976132



97617 PASTERI

ceiling light; steel, white / fabric, linen, grey, white
Deckenleuchte; Stahl, weiss / Textil, Leinen, grau, weiss
plafonnier; acier, blanc / tissu, lin, gris, blanc

H 150, Ø 760



9 002759 976170



97622 PASTERI

ceiling light; steel, white / fabric, linen, grey, white
Deckenleuchte; Stahl, weiss / Textil, Leinen, grau, weiss
plafonnier; acier, blanc / tissu, lin, gris, blanc

H 170, Ø 980



9 002759 976224



DESIGN
HIGHLIGHT
DETAIL



97614 PASTERI

ceiling light; steel, white / fabric, linen, brown, white
Deckenleuchte; Stahl, weiss / Textil, Leinen, braun, weiss
plafonnier; acier, blanc / tissu, lin, marron, blanc

H 150, Ø 570



E27



3x 25W



9 002759 976149



97618 PASTERI

ceiling light; steel, white / fabric, linen, brown, white
Deckenleuchte; Stahl, weiss / Textil, Leinen, braun, weiss
plafonnier; acier, blanc / tissu, lin, marron, blanc

H 150, Ø 760



E27



5x 25W



9 002759 976187





97612 PASTERI

ceiling light; steel, white / fabric, taupe, white
Deckenleuchte; Stahl, weiss / Textil, taupe, weiss
plafonnier; acier, blanc / tissu, taupe, blanc

H 150, Ø 570



97616 PASTERI

ceiling light; steel, white / fabric, taupe, white
Deckenleuchte; Stahl, weiss / Textil, taupe, weiss
plafonnier; acier, blanc / tissu, taupe, blanc

H 150, Ø 760



97621 PASTERI

ceiling light; steel, white / fabric, taupe, white
Deckenleuchte; Stahl, weiss / Textil, taupe, weiss
plafonnier; acier, blanc / tissu, taupe, blanc

H 170, Ø 980

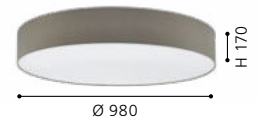



99299



99299 | 99302



99089



99298

99299 POSADERRA

ceiling light; steel, white / fabric, plastic, white
Deckenleuchte; Stahl, weiss / Textil, Kunststoff, weiss
plafonnier; acier, blanc / tissu, plastique, blanc

L 140, B 140, H 150



E27



1x 28W

99089 PASTERI SQUARE

ceiling light; steel, white / fabric, plastic, white
Deckenleuchte; Stahl, weiss / Textil, Kunststoff, weiss
plafonnier; acier, blanc / tissu, plastique, blanc

L 575, B 575, H 165



E27



5x 25W

99298 POSADERRA

ceiling light; steel, white / fabric, plastic, white
Deckenleuchte; Stahl, weiss / Textil, Kunststoff, weiss
plafonnier; acier, blanc / tissu, plastique, blanc

L 750, B 280, H 150



E27



3x 28W



9 002759 992996

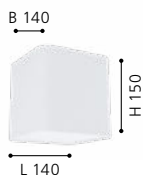

9 002759 990893



9 002759 992989

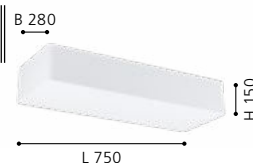



99302



99091



99301



99089 | 99298 | 99091 | 99301

99302 POSADERRA

ceiling light; steel, white / fabric, plastic, taupe, white
Deckenleuchte; Stahl, weiss / Textil, Kunststoff, taupe, weiss
plafonnier; acier, blanc / tissu, plastique, taupe, blanc

L 140, B 140, H 150



E27 1x 28W

99091 PASTERI SQUARE

ceiling light; steel, white / fabric, plastic, taupe, white
Deckenleuchte; Stahl, weiss / Textil, Kunststoff, taupe, weiss
plafonnier; acier, blanc / tissu, plastique, taupe, blanc

L 575, B 575, H 165



E27 5x 25W

99301 POSADERRA

ceiling light; steel, white / fabric, plastic, taupe, white
Deckenleuchte; Stahl, weiss / Textil, Kunststoff, taupe, weiss
plafonnier; acier, blanc / tissu, plastique, taupe, blanc

L 750, B 280, H 150



E27 3x 28W



9 002759 993023

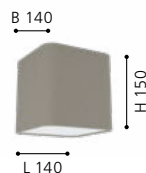

9 002759 990916



9 002759 993016

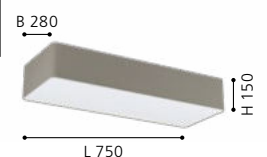

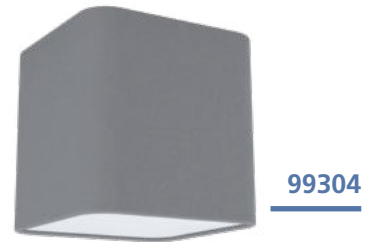

99304 POSADERRA

ceiling light; steel, white / fabric, plastic, grey, white
Deckenleuchte; Stahl, weiss / Textil, Kunststoff, grau, weiss
plafonnier; acier, blanc / tissu, plastique, gris, blanc

L 140, B 140, H 150



99092 PASTERI SQUARE

ceiling light; steel, white / fabric, plastic, grey, white
Deckenleuchte; Stahl, weiss / Textil, Kunststoff, grau, weiss
plafonnier; acier, blanc / tissu, plastique, gris, blanc

L 575, B 575, H 165



99303 POSADERRA

ceiling light; steel, white / fabric, plastic, grey, white
Deckenleuchte; Stahl, weiss / Textil, Kunststoff, grau, weiss
plafonnier; acier, blanc / tissu, plastique, gris, blanc

L 750, B 280, H 150

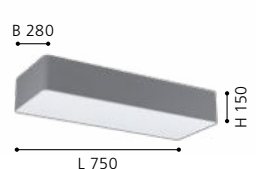
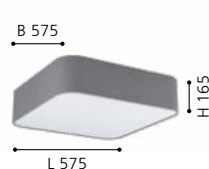
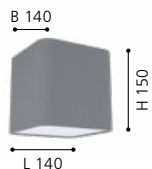



99303



31581



31585

31581 PASTERI

pendant light; steel, satin nickel / fabric, taupe
 Hängeleuchte; Stahl, nickel-matt / Textil, taupe
 luminaire en suspension; acier, nickel mat / tissu, taupe

L 750, B 220, H 1100

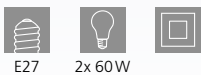

E27 2x 60W



9 002759 315818

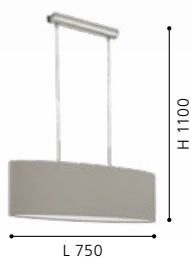

31585 PASTERI

pendant light; steel, satin nickel / fabric, taupe
 Hängeleuchte; Stahl, nickel-matt / Textil, taupe
 luminaire en suspension; acier, nickel mat / tissu, taupe

L 1000, B 280, H 1100

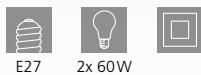

E27 2x 60W



9 002759 315856



31572 PASTERI

pendant light; steel, satin nickel / fabric, taupe
 Hängeleuchte; Stahl, nickel-matt / Textil, taupe
 luminaire en suspension; acier, nickel mat / tissu, taupe

H 1100, Ø 380



E27 1x 60W



9 002759 315726

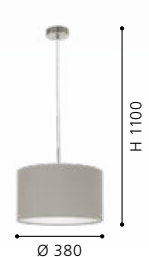



31572



31576

31576 PASTERI

pendant light; steel, satin nickel / fabric, taupe
 Hängeleuchte; Stahl, nickel-matt / Textil, taupe
 luminaire en suspension; acier, nickel mat / tissu, taupe

H 1100, Ø 530



E27



1x 60W



9 002759 315764





94919



94919



94925



96478



94919 PASTERI

ceiling light; steel, satin nickel / fabric, glass, taupe
Deckenleuchte; Stahl, nickel-matt / Textil, Glas, taupe
plafonnier; acier, nickel mat / tissu, verre, taupe

H 195, Ø 475



94925 PASTERI

wall light; steel, satin nickel / fabric, taupe
Wandleuchte; Stahl, nickel-matt / Textil, taupe
applique; acier, nickel mat / tissu, taupe

L 145, H 305, A 195



96478 PASTERI

wall light; steel, satin nickel / fabric, taupe
Wandleuchte; Stahl, nickel-matt / Textil, taupe
applique; acier, nickel mat / tissu, taupe

L 150, H 380, A 195

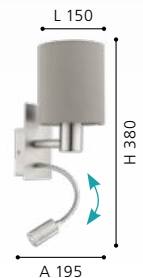



95122



95122

These luminaires can be switched on and off by touching the specially designed "Touch Me" part of the fixture.

Diese Leuchten können ein- und ausgeschaltet werden, indem man sie an den dafür vorgesehenen "Touch Me" Bereichen berührt.

Ces luminaires peuvent être éteints et allumés simplement en touchant la partie spécialement conçue pour "Touch Me" du luminaire.



31595



95167

95122 PASTERI

table light; steel, satin nickel / fabric, taupe
Tischleuchte; Stahl, nickel-matt / Textil, taupe
luminaire de table; acier, nickel mat / tissu, taupe

H 255, Ø 120



31595 PASTERI

table light; steel, satin nickel / fabric, taupe
Tischleuchte; Stahl, nickel-matt / Textil, taupe
luminaire de table; acier, nickel mat / tissu, taupe

H 400, Ø 180

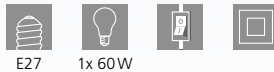

95167 PASTERI

floor light; steel, satin nickel / fabric, taupe
Stehleuchte; Stahl, nickel-matt / Textil, taupe
lampadaire; acier, nickel mat / tissu, taupe

H 1575, Ø 280, Base: Ø 230

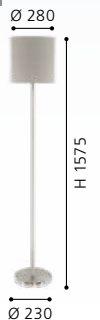



31582



31592

LED



31586

31582 PASTERI

pendant light; steel, satin nickel / fabric, grey
 Hängeleuchte; Stahl, nickel-matt / Textil, grau
 luminaire en suspension; acier, nickel mat / tissu, gris

L 750, B 220, H 1100



E27 2x 60W



9 002759 315825



31586 PASTERI

pendant light; steel, satin nickel / fabric, grey
 Hängeleuchte; Stahl, nickel-matt / Textil, grau
 luminaire en suspension; acier, nickel mat / tissu, gris

L 1000, B 280, H 1100



E27 2x 60W



9 002759 315863



31592 PASTERI

ceiling light; plastic, steel, white / fabric, grey
 Deckenleuchte; Kunststoff, Stahl, weiss / Textil, grau
 plafonnier; plastique, acier, blanc / tissu, gris

H 90, Ø 320

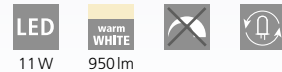

LED 11W warm WHITE 950lm



9 002759 315924





94921 PASTERI

ceiling light; steel, satin nickel / fabric, glass, grey
Deckenleuchte; Stahl, nickel-matt / Textil, Glas, grau
plafonnier; acier, nickel mat / tissu, verre, gris

H 195, Ø 475



31577 PASTERI

pendant light; steel, satin nickel / fabric, grey
Hängeleuchte; Stahl, nickel-matt / Textil, grau
luminaire en suspension; acier, nickel mat / tissu, gris

H 1100, Ø 530



31573 PASTERI

pendant light; steel, satin nickel / fabric, grey
Hängeleuchte; Stahl, nickel-matt / Textil, grau
luminaire en suspension; acier, nickel mat / tissu, gris

H 1100, Ø 380

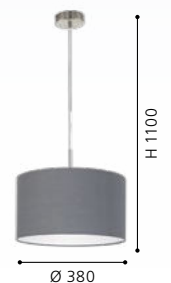



94926



96479

LED

94926 PASTERI

wall light; steel, satin nickel / fabric, grey
Wandleuchte; Stahl, nickel-matt / Textil, grau
applique; acier, nickel mat / tissu, gris

L 145, H 305, A 195



E27 1x 60W



9 002759 949266



96479 PASTERI

wall light; steel, satin nickel / fabric, grey
Wandleuchte; Stahl, nickel-matt / Textil, grau
applique; acier, nickel mat / tissu, gris

L 150, H 380, A 195



E27 1x 40W 1x 3,5W 1x 380lm



9 002759 964795

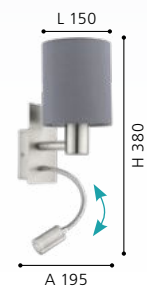



95119



95119

These luminaires can be switched on and off by touching the specially designed "Touch Me" part of the fixture.

Diese Leuchten können ein- und ausgeschaltet werden, indem man sie an den dafür vorgesehenen "Touch Me" Bereichen berührt.

Ces luminaires peuvent être éteints et allumés simplement en touchant la partie spécialement conçue pour "Touch Me" du luminaire.



31596



95166

95119 PASTERI

table light; steel, satin nickel / fabric, grey
Tischleuchte; Stahl, nickel-matt / Textil, grau
luminaire de table; acier, nickel mat / tissu, gris

H 255, Ø 120



E27 1x 40W



9 002759 951191



31596 PASTERI

table light; steel, satin nickel / fabric, grey
Tischleuchte; Stahl, nickel-matt / Textil, grau
luminaire de table; acier, nickel mat / tissu, gris

H 400, Ø 180

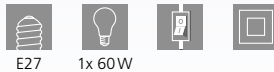

E27 1x 60W



9 002759 315962



95166 PASTERI

floor light; steel, satin nickel / fabric, grey
Stehleuchte; Stahl, nickel-matt / Textil, grau
lampadaire; acier, nickel mat / tissu, gris

H 1575, Ø 280, Base: Ø 230



E27 1x 60W



9 002759 951665





31583

31583 PASTERI

pendant light; steel, satin nickel / fabric, anthracite-brown
Hängeleuchte; Stahl, nickel-matt / Textil, anthrazit-braun
luminaire en suspension; acier, nickel mat / tissu, anthracite
marron

L 750, B 220, H 1100



E27



2x 60W





31578 PASTERI

pendant light; steel, satin nickel / fabric, anthracite-brown
Hängeleuchte; Stahl, nickel-matt / Textil, anthrazit-braun
luminaire en suspension; acier, nickel mat / tissu, anthracite marron

H 1100, Ø 530

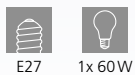

31574 PASTERI

pendant light; steel, satin nickel / fabric, anthracite-brown
Hängeleuchte; Stahl, nickel-matt / Textil, anthrazit-braun
luminaire en suspension; acier, nickel mat / tissu, anthracite marron

H 1100, Ø 380

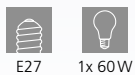

96481 PASTERI

wall light; steel, satin nickel / fabric, anthracite-brown
Wandleuchte; Stahl, nickel-matt / Textil, anthrazit-braun
applique; acier, nickel mat / tissu, anthracite marron

L 150, H 380, A 195

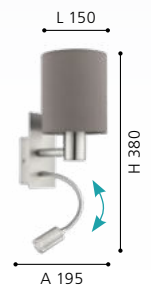
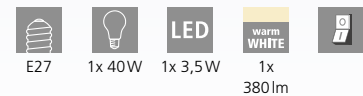



31579



31575

DESIGN
HIGHLIGHT
DETAIL



31579 PASTERI

pendant light; steel, satin nickel / fabric, white
Hängeleuchte; Stahl, nickel-matt / Textil, weiss
luminaire en suspension; acier, nickel mat / tissu, blanc

L 750, B 220, H 1100



31575 PASTERI

pendant light; steel, satin nickel / fabric, white
Hängeleuchte; Stahl, nickel-matt / Textil, weiss
luminaire en suspension; acier, nickel mat / tissu, blanc

H 1100, Ø 530





31571



94918



31588

LED



EGLO
RECOMMENDS
11596

94918

31571 PASTERI

pendant light; steel, satin nickel / fabric, white
Hängeleuchte; Stahl, nickel-matt / Textil, weiss
luminaire en suspension; acier, nickel mat / tissu, blanc

H 1100, Ø 380



9 002759 315719



31588 PASTERI

ceiling light; plastic, steel, white / fabric, white
Deckenleuchte; Kunststoff, Stahl, weiss / Textil, weiss
plafonnier; plastique, acier, blanc / tissu, blanc

H 90, Ø 320



9 002759 315887



94918 PASTERI

ceiling light; steel, satin nickel / fabric, glass, white
Deckenleuchte; Stahl, nickel-matt / Textil, Glas, weiss
plafonnier; acier, nickel mat / tissu, verre, blanc

H 195, Ø 475



9 002759 949181





94924



95118



96477

LED

95118

These luminaires can be switched on and off by touching the specially designed "Touch Me" part of the fixture.

Diese Leuchten können ein- und ausgeschaltet werden, indem man sie an den dafür vorgesehenen "Touch Me" Bereichen berührt.

Ces luminaires peuvent être éteints et allumés simplement en touchant la partie spécialement conçue pour "Touch Me" du luminaire.



96477 PASTERI

wall light; steel, satin nickel / fabric, white
Wandleuchte; Stahl, nickel-matt / Textil, weiss
applique; acier, nickel mat / tissu, blanc

L 150, H 380, A 195



E27

1x 40W

1x 3,5W

1x

380lm



9 002759 964771

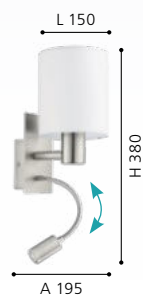

94924 PASTERI

wall light; steel, satin nickel / fabric, white
Wandleuchte; Stahl, nickel-matt / Textil, weiss
applique; acier, nickel mat / tissu, blanc

L 145, H 305, A 195



E27

1x 60W



9 002759 949242



95118 PASTERI

table light; steel, satin nickel / fabric, white
Tischleuchte; Stahl, nickel-matt / Textil, weiss
luminaire de table; acier, nickel mat / tissu, blanc

H 255, Ø 120



E27

1x 40W



9 002759 951184





31594



95164

31594 PASTERI

table light; steel, satin nickel / fabric, white
 Tischleuchte; Stahl, nickel-matt / Textil, weiss
 luminaire de table; acier, nickel mat / tissu, blanc

H 400, Ø 180

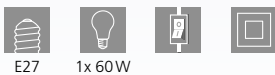

E27 1x 60W



95164 PASTERI

floor light; steel, satin nickel / fabric, white
 Stehleuchte; Stahl, nickel-matt / Textil, weiss
 lampadaire; acier, nickel mat / tissu, blanc

H 1575, Ø 280, Base: Ø 230



E27 1x 60W

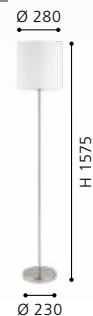



95044



95045



95044 PASTERI

pendant light; steel, satin nickel / fabric, white, copper
 Hängeleuchte; Stahl, nickel-matt / Textil, weiss, kupfer
 luminaire en suspension; acier, nickel mat / tissu, blanc, cuivre

H 1100, Ø 380



E27



1x 60W



9 002759 950446



95045 PASTERI

pendant light; steel, satin nickel / fabric, white, copper
 Hängeleuchte; Stahl, nickel-matt / Textil, weiss, kupfer
 luminaire en suspension; acier, nickel mat / tissu, blanc, cuivre

H 1100, Ø 530



E27



1x 60W



9 002759 950453





96483

LED



96484

LED

96483 PASTERI

wall light; steel, satin nickel / fabric, black, copper
 Wandleuchte; Stahl, nickel-matt / Textil, schwarz, kupfer
 applique; acier, nickel mat / tissu, noir, cuivre

L 150, H 380, A 195

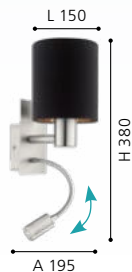

96484 PASTERI

wall light; steel, satin nickel / fabric, white, copper
 Wandleuchte; Stahl, nickel-matt / Textil, weiss, kupfer
 applique; acier, nickel mat / tissu, blanc, cuivre

L 150, H 380, A 195





97643

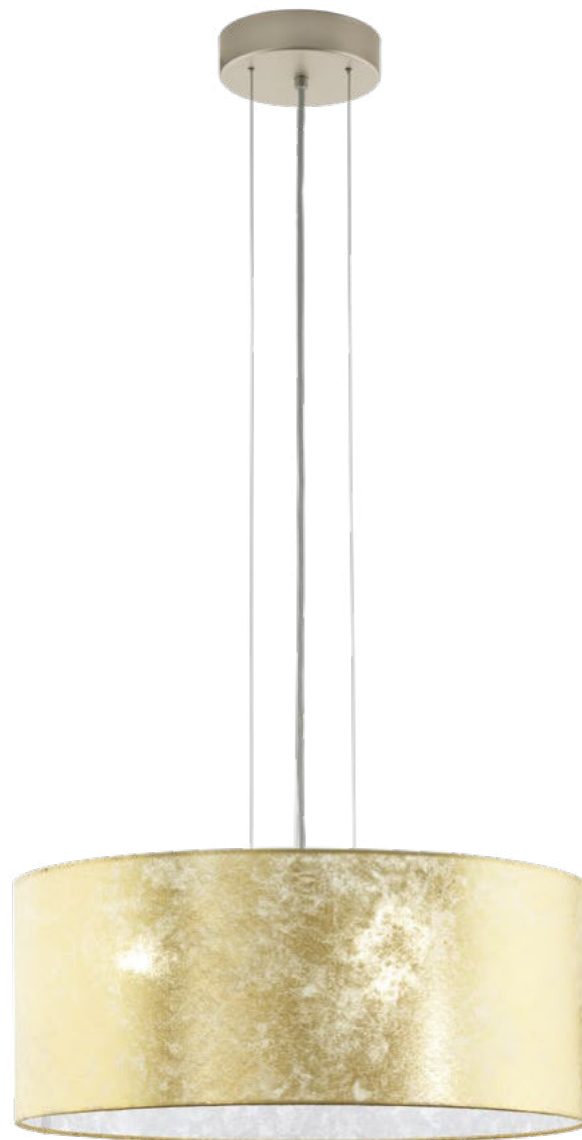

97644

97643 VISERBELLA

pendant light; steel, champagne / fabric, gold
 Hängeleuchte; Stahl, champagner / Textil, gold
 luminaire en suspension; acier, champagne / tissu, or

H 1100, Ø 380



9 002759 976439

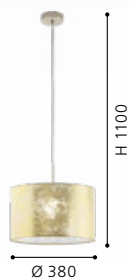

97644 VISERBELLA

pendant light; steel, champagne / fabric, gold
 Hängeleuchte; Stahl, champagner / Textil, gold
 luminaire en suspension; acier, champagne / tissu, or

H 1100, Ø 530



9 002759 976446

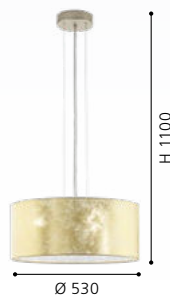

97641 VISERBELLA

ceiling light; steel, champagne / fabric, gold
 Deckenleuchte; Stahl, champagner / Textil, gold
 plafonnier; acier, champagne / tissu, or

H 110, Ø 380



9 002759 976415





97641



97642



97641 | 97642

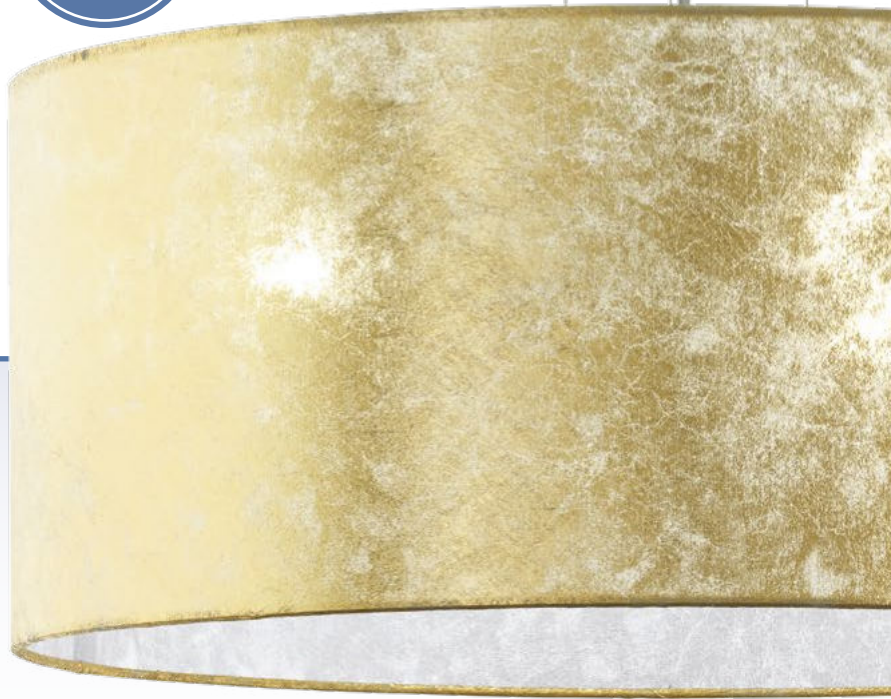

97642 VISERBELLA

ceiling light; steel, champagne / fabric, gold
Deckenleuchte; Stahl, champagner / Textil, gold
plafonnier; acier, champagne / tissu, or

H 195, Ø 470





DESIGN
HIGHLIGHT
DETAIL



97645



97647

97645 VISERBELLA

wall light; steel, champagne / fabric, gold
Wandleuchte; Stahl, champagner / Textil, gold
applique; acier, champagne / tissu, or

L 145, H 305, A 195

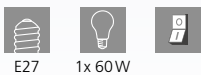

E27 1x 60W



9 002759 976453

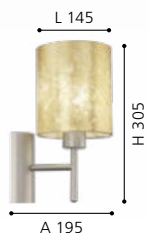

97647 VISERBELLA

floor light; steel, champagne / fabric, gold
Stehleuchte; Stahl, champagner / Textil, gold
lampadaire; acier, champagne / tissu, or

H 1585, Ø 280, Base: Ø 230

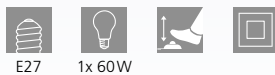

E27 1x 60W



9 002759 976477

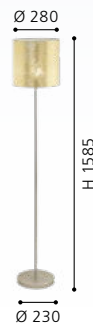

97646 VISERBELLA

table light; steel, champagne / fabric, gold
Tischleuchte; Stahl, champagner / Textil, gold
luminaire de table; acier, champagne / tissu, or

H 400, Ø 180, Base: Ø 150

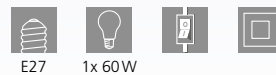

E27 1x 60W



9 002759 976460

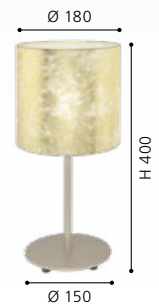



97646



DESIGN
HIGHLIGHT
DETAIL



99272

99273

99273 ESTEPERRA

pendant light; steel, black / fabric, black, gold
Hängeleuchte; Stahl, schwarz / Textil, schwarz, gold
luminaire en suspension; acier, noir / tissu, noir, or

H 1100, Ø 380



99272 ESTEPERRA

ceiling light; steel, black / fabric, black, gold
Deckenleuchte; Stahl, schwarz / Textil, schwarz, gold
plafonnier; acier, noir / tissu, noir, or

H 240, Ø 475

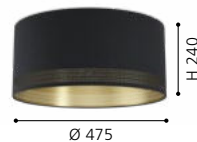

99274 ESTEPERRA

pendant light; steel, black / fabric, black, gold
Hängeleuchte; Stahl, schwarz / Textil, schwarz, gold
luminaire en suspension; acier, noir / tissu, noir, or

H 1100, Ø 530

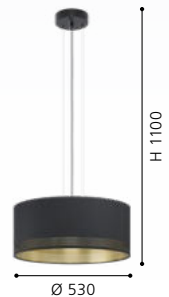



99274





99279

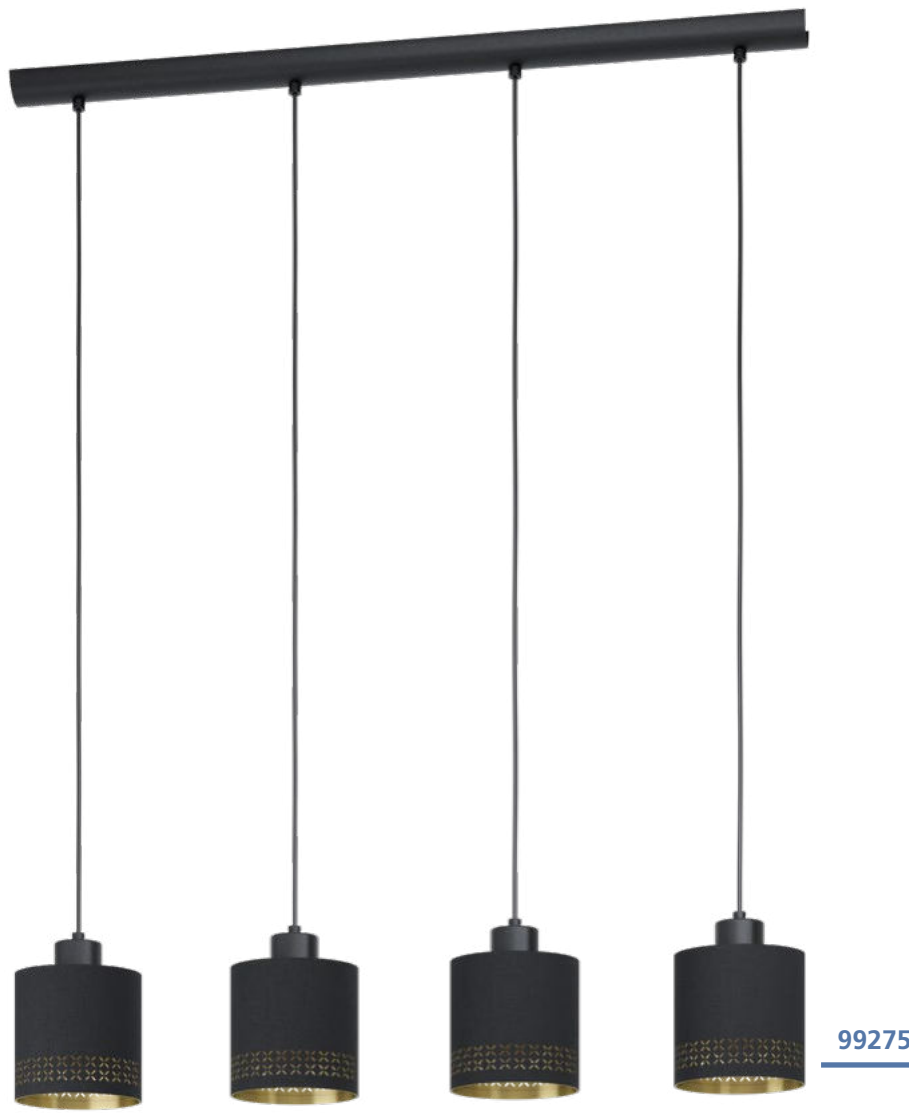

DESIGN
HIGHLIGHT
DETAIL



99279 ESTEPERRA

floor light; steel, black / fabric, black, gold
Stehleuchte; Stahl, schwarz / Textil, schwarz, gold
lampadaire; acier, noir / tissu, noir, or

H 1405, Ø 380, Base: Ø 645



E27 1x 40W



9 002759 992798

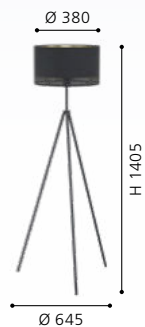

H 1405

Ø 645

99275 ESTEPERRA

pendant light; steel, black / fabric, black, gold
Hängeleuchte; Stahl, schwarz / Textil, schwarz, gold
luminaire en suspension; acier, noir / tissu, noir, or

L 940, B 160, H 1100



E27 4x 28W



9 002759 992750



H 1100

L 940

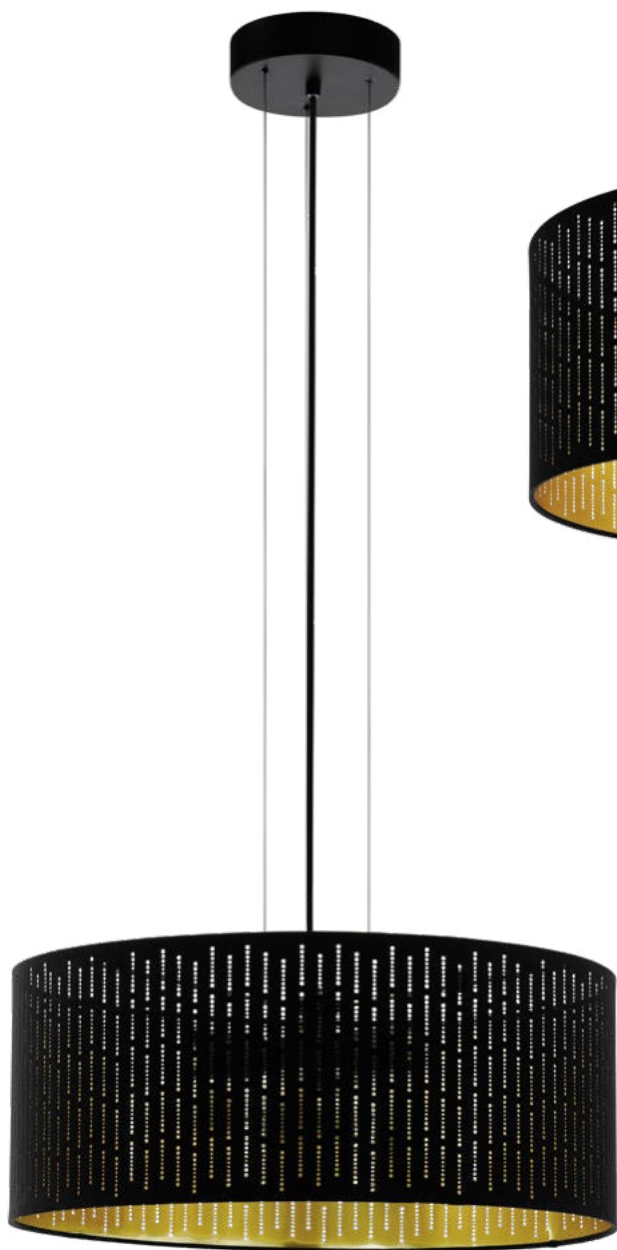

98313

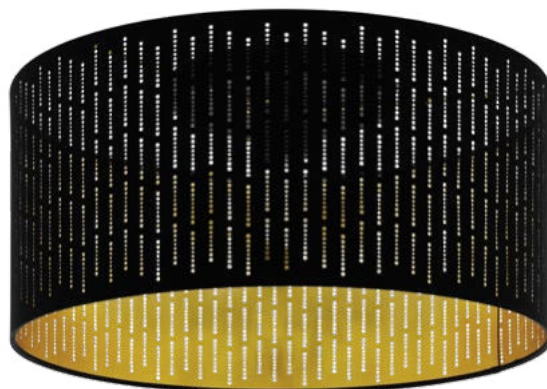

98311



98314

98313 VARILLAS

pendant light; steel, black / fabric with cut-outs, black, gold
Hängeleuchte; Stahl, schwarz / Textil mit Ausstanzungen, schwarz, gold

luminaire en suspension; acier, noir / tissu avec découpes, noir, or

H 1100, Ø 530



E27



3x 40W



9 002759 983130



98311 VARILLAS

ceiling light; steel, black / fabric with cut-outs, black, gold
Deckenleuchte; Stahl, schwarz / Textil mit Ausstanzungen, schwarz, gold

plafonnier; acier, noir / tissu avec découpes, noir, or

H 240, Ø 475



E27



1x 40W



9 002759 983116

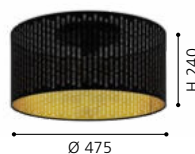

98314 VARILLAS

table light; steel, black / fabric with cut-outs, black, gold
Tischleuchte; Stahl, schwarz / Textil mit Ausstanzungen, schwarz, gold

luminaire de table; acier, noir / tissu avec découpes, noir, or

H 255, Ø 120



E27



1x 40W



9 002759 983147

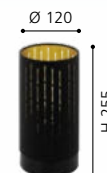



98315



98315 VARILLAS

floor light; steel, black / fabric with cut-outs, black, gold
Stehleuchte; Stahl, schwarz / Textil mit Ausstanzungen, schwarz,
gold
lampadaire; acier, noir / tissu avec découpes, noir, or

H 1510, Ø 380, Base: Ø 250



E27



1x 40W



9 002759 983154

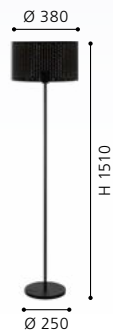



99613

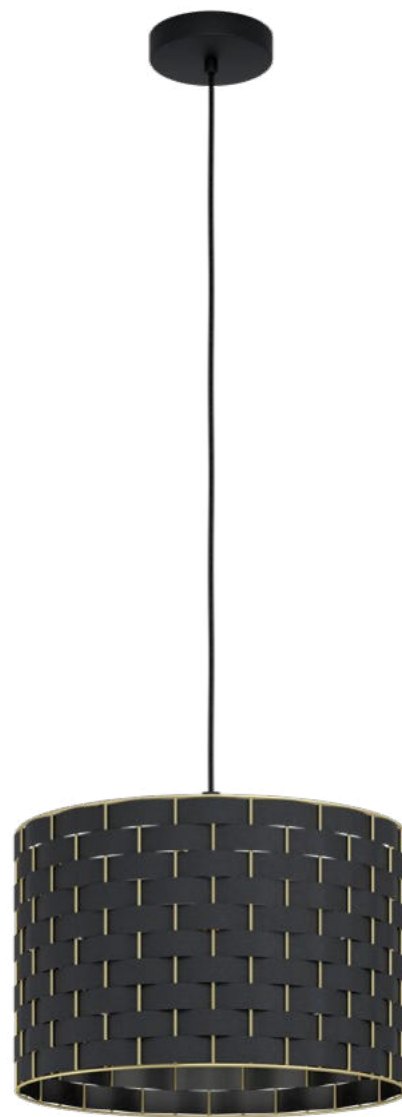

99524

99613 MARASALES

pendant light; steel, black / fabric, black, brass
 Hängeleuchte; Stahl, schwarz / Textil, schwarz, messing
 luminaire en suspension; acier, noir / tissu, noir, laiton

L 780, B 220, H 1100



E27 2x 40W



9 002759 996130



99524 MARASALES

pendant light; steel, black / fabric, black, brass
 Hängeleuchte; Stahl, schwarz / Textil, schwarz, messing
 luminaire en suspension; acier, noir / tissu, noir, laiton

H 1100, Ø 380



E27 1x 40W



9 002759 995249



99525 MARASALES

pendant light; steel, black / fabric, black, brass
 Hängeleuchte; Stahl, schwarz / Textil, schwarz, messing
 luminaire en suspension; acier, noir / tissu, noir, laiton

H 1100, Ø 550

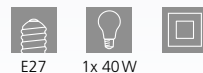

E27 1x 40W



9 002759 995256



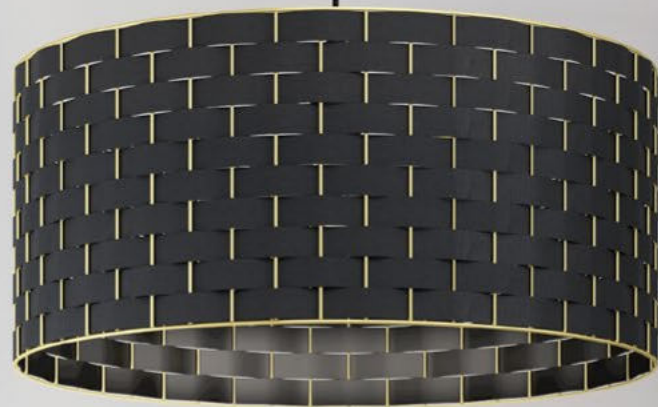

99525





99523



99526

99523 MARASALES

ceiling light; steel, black / fabric, black, brass
Deckenleuchte; Stahl, schwarz / Textil, schwarz, messing
plafonnier; acier, noir / tissu, noir, laiton

H 250, Ø 480

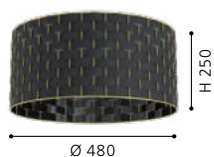

99526 MARASALES

table light; steel, black / fabric, black, brass
Tischleuchte; Stahl, schwarz / Textil, schwarz, messing
luminaire de table; acier, noir / tissu, noir, laiton

H 570, Ø 280

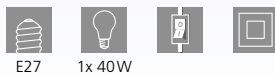

99527 MARASALES

floor light; steel, black / fabric, black, brass
Stehleuchte; Stahl, schwarz / Textil, schwarz, messing
lampadaire; acier, noir / tissu, noir, laiton

H 1490, Ø 450, Base: Ø 745

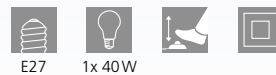



99527



31601



99543

LED



31606

31601 MASERLO

pendant light; steel, satin nickel / fabric, grey, silver
 Hängeleuchte; Stahl, nickel-matt / Textil, grau, silber
 luminaire en suspension; acier, nickel mat / tissu, gris, argent

H 1100, Ø 380



E27 1x 60W



31606 MASERLO

pendant light; steel, satin nickel / fabric, grey, silver
 Hängeleuchte; Stahl, nickel-matt / Textil, grau, silber
 luminaire en suspension; acier, nickel mat / tissu, gris, argent

H 1100, Ø 530



E27 3x 60W



99543 MASERLO 2

ceiling light; plastic, steel, white / fabric, grey, silver
 Deckenleuchte; Kunststoff, Stahl, weiss / Textil, grau, silber
 plafonnier; plastique, acier, blanc / tissu, gris, argent

H 90, Ø 380



LED 24W warm WHITE 2100lm





31628



95173



31628 MASERLO

table light; steel, satin nickel / fabric, grey, silver
Tischleuchte; Stahl, nickel-matt / Textil, grau, silber
luminaire de table; acier, nickel mat / tissu, gris, argent

H 420, Ø 230

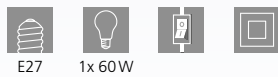

E27 1x 60W



95173 MASERLO

floor light; steel, satin nickel / fabric, grey, silver
Stehleuchte; Stahl, nickel-matt / Textil, grau, silber
lampadaire; acier, nickel mat / tissu, gris, argent

H 1510, Ø 380, Base: Ø 250



E27 1x 60W

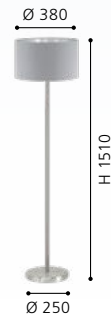



99044





99042



99043



MASERLO 1

99044 MASERLO 1

pendant light; steel, black / fabric, black
 Hängeleuchte; Stahl, schwarz / Textil, schwarz
 luminaire en suspension; acier, noir / tissu, noir

L 780, B 220, H 1100



99042 MASERLO 1

pendant light; steel, black / fabric, black
 Hängeleuchte; Stahl, schwarz / Textil, schwarz
 luminaire en suspension; acier, noir / tissu, noir

H 1100, Ø 380

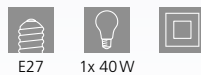

99043 MASERLO 1

pendant light; steel, black / fabric, black
 Hängeleuchte; Stahl, schwarz / Textil, schwarz
 luminaire en suspension; acier, noir / tissu, noir

H 1100, Ø 530

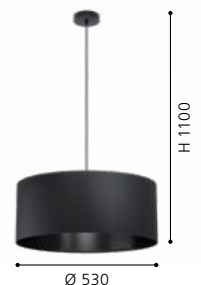
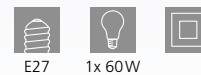



DESIGN
HIGHLIGHT
DETAIL



99041



MASERLO 1



99045

99041 MASERLO 1

ceiling light; steel, black / fabric, black
Deckenleuchte; Stahl, schwarz / Textil, schwarz
plafonnier; acier, noir / tissu, noir

H 240, Ø 400



E27 1x 40W

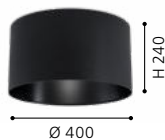

99045 MASERLO 1

table light; steel, black / fabric, black
Tischleuchte; Stahl, schwarz / Textil, schwarz
luminaire de table; acier, noir / tissu, noir

H 415, Ø 230, Base: Ø 145



E27 1x 40W



99046 MASERLO 1

floor light; steel, black / fabric, black
Stehleuchte; Stahl, schwarz / Textil, schwarz
lampadaire; acier, noir / tissu, noir

H 1515, Ø 380, Base: Ø 250



E27 1x 40W

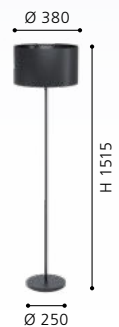



99046



31611



31616



31611 MASERLO

pendant light; steel, satin nickel / fabric, black, gold
 Hängeleuchte; Stahl, nickel-matt / Textil, schwarz, gold
 luminaire en suspension; acier, nickel mat / tissu, noir, or

L 780, B 220, H 1100

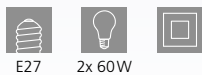

E27 2x 60W

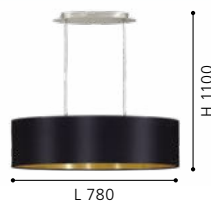

31616 MASERLO

pendant light; steel, satin nickel / fabric, black, gold
 Hängeleuchte; Stahl, nickel-matt / Textil, schwarz, gold
 luminaire en suspension; acier, nickel mat / tissu, noir, or

L 1000, B 250, H 1100

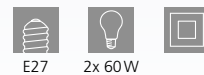

E27 2x 60W

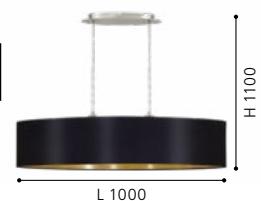



31599



31605

31599 MASERLO

pendant light; steel, satin nickel / fabric, black, gold
 Hängeleuchte; Stahl, nickel-matt / Textil, schwarz, gold
 luminaire en suspension; acier, nickel mat / tissu, noir, or

H 1100, Ø 380

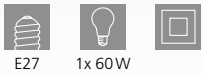

E27 1x 60W

31605 MASERLO

pendant light; steel, satin nickel / fabric, black, gold
 Hängeleuchte; Stahl, nickel-matt / Textil, schwarz, gold
 luminaire en suspension; acier, nickel mat / tissu, noir, or

H 1100, Ø 530



E27 3x 60W



9 002759 315993

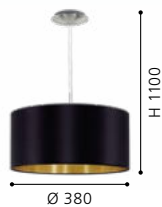

9 002759 316051

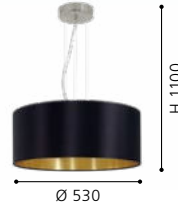



99539



31627

99539 MASERLO 2

ceiling light; plastic, steel, white / fabric, black, gold
Deckenleuchte; Kunststoff, Stahl, weiss / Textil, schwarz, gold
plafonnier; plastique, acier, blanc / tissu, noir, or

H 90, Ø 380



24W



2100lm



9 002759 995393

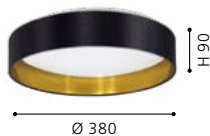

31627 MASERLO

table light; steel, satin nickel / fabric, black, gold
Tischleuchte; Stahl, nickel-matt / Textil, schwarz, gold
luminaire de table; acier, nickel mat / tissu, noir, or

H 420, Ø 230



E27



1x 60W



9 002759 316273



95169 MASERLO

floor light; steel, satin nickel / fabric, black, gold
Stehleuchte; Stahl, nickel-matt / Textil, schwarz, gold
lampadaire; acier, nickel mat / tissu, noir, or

H 1510, Ø 380, Base: Ø 250



E27



1x 60W



9 002759 951696

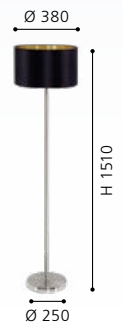



95169



31618 MASERLO

pendant light; steel, satin nickel / fabric, taupe, gold
 Hängeleuchte; Stahl, nickel-matt / Textil, taupe, gold
 luminaire en suspension; acier, nickel mat / tissu, taupe, or

L 1000, B 250, H 1100



9 002759 316181

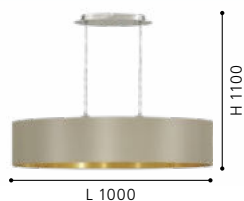

31602 MASERLO

pendant light; steel, satin nickel / fabric, taupe, gold
 Hängeleuchte; Stahl, nickel-matt / Textil, taupe, gold
 luminaire en suspension; acier, nickel mat / tissu, taupe, or

H 1100, Ø 380

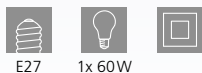

9 002759 316020



31607 MASERLO

pendant light; steel, satin nickel / fabric, taupe, gold
 Hängeleuchte; Stahl, nickel-matt / Textil, taupe, gold
 luminaire en suspension; acier, nickel mat / tissu, taupe, or

H 1100, Ø 530



9 002759 316075

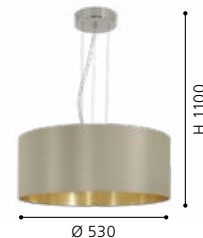



99541

LED



31613

99541 MASERLO 2

ceiling light; plastic, steel, white / fabric, taupe, gold
Deckenleuchte; Kunststoff, Stahl, weiss / Textil, taupe, gold
plafonnier; plastique, acier, blanc / tissu, taupe, or

H 90, Ø 380



24W 2100lm



9 002759 995416

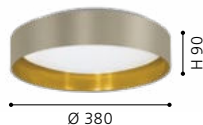

Ø 380

31613 MASERLO

pendant light; steel, satin nickel / fabric, taupe, gold
Hängeleuchte; Stahl, nickel-matt / Textil, taupe, gold
luminaire en suspension; acier, nickel mat / tissu, taupe, or

L 780, B 220, H 1100



E27 2x 60W



9 002759 316136

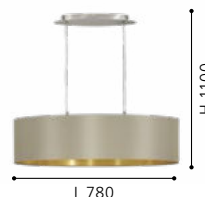

L 780

H 1100





95055 MASERLO

wall light; steel, satin nickel / fabric, taupe, gold
Wandleuchte; Stahl, nickel-matt / Textil, taupe, gold
applique; acier, nickel mat / tissu, taupe, or

H 260, Ø 230, A 595

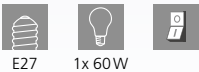

E27 1x 60W



31629 MASERLO

table light; steel, satin nickel / fabric, taupe, gold
Tischleuchte; Stahl, nickel-matt / Textil, taupe, gold
luminaire de table; acier, nickel mat / tissu, taupe, or

H 420, Ø 230

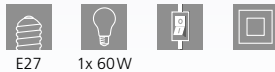

E27 1x 60W



95171 MASERLO

floor light; steel, satin nickel / fabric, taupe, gold
Stehleuchte; Stahl, nickel-matt / Textil, taupe, gold
lampadaire; acier, nickel mat / tissu, taupe, or

H 1510, Ø 380, Base: Ø 250



E27 1x 60W





31614 MASERLO

pendant light; steel, satin nickel / fabric, cappuccino, gold
 Hängeleuchte; Stahl, nickel-matt / Textil, cappuccino, gold
 luminaire en suspension; acier, nickel mat / tissu, cappucino, or

L 780, B 220, H 1100



E27 2x 60W



9 002759 316143

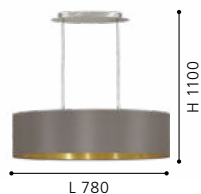

31619 MASERLO

pendant light; steel, satin nickel / fabric, cappuccino, gold
 Hängeleuchte; Stahl, nickel-matt / Textil, cappuccino, gold
 luminaire en suspension; acier, nickel mat / tissu, cappucino, or

L 1000, B 250, H 1100

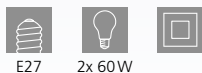

E27 2x 60W



9 002759 316198

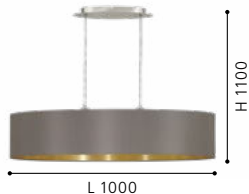

31603 MASERLO

pendant light; steel, satin nickel / fabric, cappuccino, gold
 Hängeleuchte; Stahl, nickel-matt / Textil, cappuccino, gold
 luminaire en suspension; acier, nickel mat / tissu, cappucino, or

H 1100, Ø 380

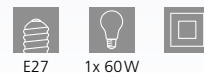

E27 1x 60W



9 002759 316037





99542

LED

DESIGN
HIGHLIGHT
DETAIL

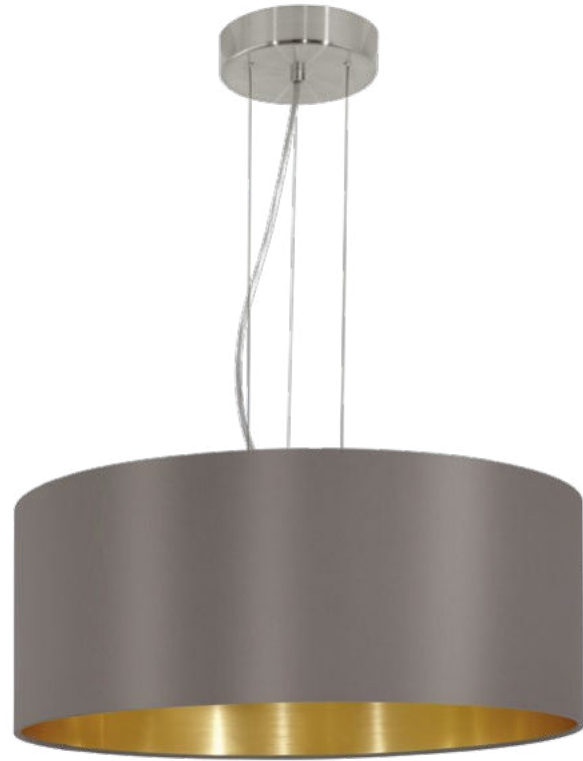

31608

99542 MASERLO 2

ceiling light; plastic, steel, white / fabric, cappuccino, gold
Deckenleuchte; Kunststoff, Stahl, weiss / Textil, cappuccino, gold
plafonnier; plastique, acier, blanc / tissu, cappuccino, or

H 90, Ø 380



24W



2100lm



9 002759 995423

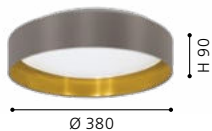

31608 MASERLO

pendant light; steel, satin nickel / fabric, cappuccino, gold
Hängeleuchte; Stahl, nickel-matt / Textil, cappuccino, gold
luminaire en suspension; acier, nickel mat / tissu, cappuccino, or

H 1100, Ø 530



E27



3x 60W



9 002759 316082

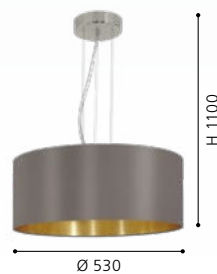

31631 MASERLO

table light; steel, satin nickel / fabric, cappuccino, gold
Tischleuchte; Stahl, nickel-matt / Textil, cappuccino, gold
luminaire de table; acier, nickel mat / tissu, cappuccino, or

H 420, Ø 230



E27



1x 60W



9 002759 316310

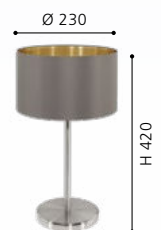



31631

95172 MASERLO

floor light; steel, satin nickel / fabric, cappuccino, gold
 Stehleuchte; Stahl, nickel-matt / Textil, cappuccino, gold
 lampadaire; acier, nickel mat / tissu, cappuccino, or

H 1510, Ø 380, Base: Ø 250



E27



1x 60W



Ø 380



9 002759 951726

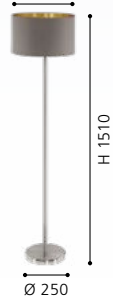

Ø 250



95172



97682

97683

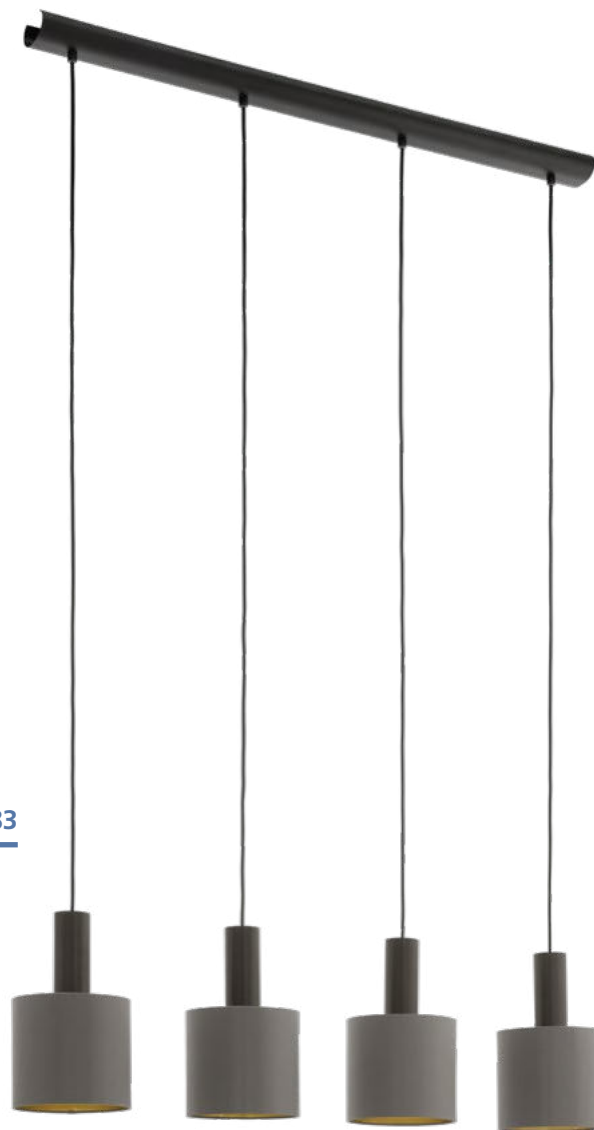

97685

97682 CONCESSA 1

pendant light; steel, dark brown / fabric, cappuccino, gold
 Hängeleuchte; Stahl, dunkelbraun / Textil, cappuccino, gold
 luminaire en suspension; acier, marron foncé / tissu, cappuccino, or

H 1500, Ø 380

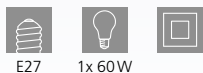

9 002759 976828

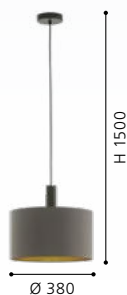

97683 CONCESSA 1

pendant light; steel, dark brown / fabric, cappuccino, gold
 Hängeleuchte; Stahl, dunkelbraun / Textil, cappuccino, gold
 luminaire en suspension; acier, marron foncé / tissu, cappuccino, or

H 1500, Ø 530

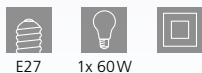

9 002759 976835



97685 CONCESSA 1

pendant light; steel, dark brown / fabric, cappuccino, gold
 Hängeleuchte; Stahl, dunkelbraun / Textil, cappuccino, gold
 luminaire en suspension; acier, marron foncé / tissu, cappuccino, or

L 940, B 160, H 1500



9 002759 976859





97684

97684 CONCESSA 1

pendant light; steel, dark brown / fabric, cappuccino, gold
Hängeleuchte; Stahl, dunkelbraun / Textil, cappuccino, gold
luminaire en suspension; acier, marron foncé / tissu, cappuccino,
or

H 1500, Ø 420

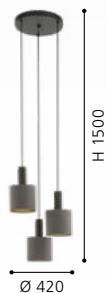

DESIGN
HIGHLIGHT
DETAIL



99445



99446



99445 ALBARIZA

pendant light; steel, wood, black, brown / fabric, cappuccino, gold

Hängeleuchte; Stahl, Holz, schwarz, braun / Textil, cappuccino, gold

luminaire en suspension; acier, bois, noir, marron / tissu, cappuccino, or

H 1100, Ø 160



E27

1x 40W



9 002759 994457

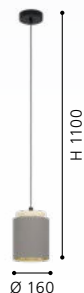

99446 ALBARIZA

pendant light; steel, wood, black, brown / fabric, cappuccino, gold

Hängeleuchte; Stahl, Holz, schwarz, braun / Textil, cappuccino, gold

luminaire en suspension; acier, bois, noir, marron / tissu, cappuccino, or

L 895, B 160, H 1100



E27

3x 40W



9 002759 994464

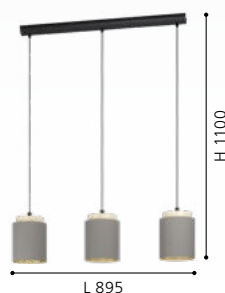

99447 ALBARIZA

pendant light; steel, wood, black, brown / fabric, cappuccino, gold

Hängeleuchte; Stahl, Holz, schwarz, braun / Textil, cappuccino, gold

luminaire en suspension; acier, bois, noir, marron / tissu, cappuccino, or

H 1500, Ø 700



E27

5x 40W



9 002759 994471

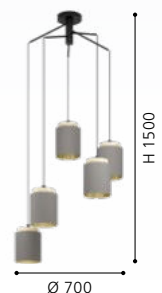



99447





99487 ALMEIDA 2

pendant light; steel, brushed brass / fabric, cappuccino, brass
 Hängeleuchte; Stahl, messing-gebürstet / Textil, cappuccino, messing
 luminaire en suspension; acier, laiton brossé / tissu, cappuccino, laiton

L 1200, B 155, H 1100

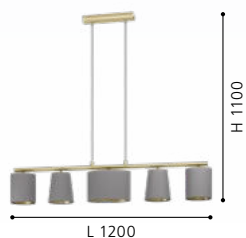
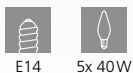

99486 ALMEIDA 2

ceiling light; steel, brushed brass / fabric, cappuccino, brass
 Deckenleuchte; Stahl, messing-gebürstet / Textil, cappuccino, messing
 plafonnier; acier, laiton brossé / tissu, cappuccino, laiton

L 810, B 155, H 280



99612 ALMEIDA 2

floor light; steel, brushed brass / fabric, cappuccino, brass
 Stehleuchte; Stahl, messing-gebürstet / Textil, cappuccino, messing
 lampadaire; acier, laiton brossé / tissu, cappuccino, laiton

H 1670, Ø 320, Base: Ø 300

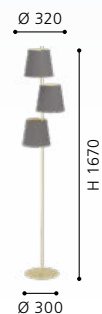



99612



99611

99611 ALMEIDA 2

table light; steel, brushed brass / fabric, cappuccino, brass
 Tischleuchte; Stahl, messing-gebürstet / Textil, cappuccino, messing
 luminaire de table; acier, laiton brossé / tissu, cappuccino, laiton

H 605, Ø 260, Base: Ø 200

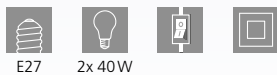

E27 2x 40W



9 002759 996116





98587



98588



98587 ALMEIDA 1

pendant light; steel, black / fabric, grey, white
 Hängeleuchte; Stahl, schwarz / Textil, grau, weiss
 luminaire en suspension; acier, noir / tissu, gris, blanc

L 860, B 255, H 1100



E14 3x 25W

98588 ALMEIDA 1

pendant light; steel, black / fabric, black, grey, white
 Hängeleuchte; Stahl, schwarz / Textil, schwarz, grau, weiss
 luminaire en suspension; acier, noir / tissu, noir, gris, blanc

L 1200, B 255, H 1100



E14 5x 25W



9 002759 985875



9 002759 985882





95193



95192



95194

95193 ALMEIDA

wall light; steel, black / fabric, white, anthracite
Wandleuchte; Stahl, schwarz / Textil, weiss, anthrazit
applique; acier, noir / tissu, blanc, anthracite

L 420, H 455, A 190



E14 2x 40W



9 002759 951931

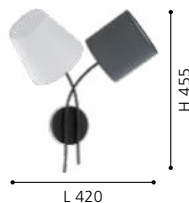

L 420

H 455

95192 ALMEIDA

ceiling light; steel, black / fabric, anthracite, white, brown
Deckenleuchte; Stahl, schwarz / Textil, anthrazit, weiss, braun
plafonnier; acier, noir / tissu, anthracite, blanc, marron

H 350, Ø 590



E14 3x 40W



9 002759 951924

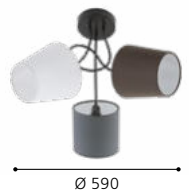

Ø 590

H 350

95194 ALMEIDA

table light; steel, black / fabric, white, anthracite
Tischleuchte; Stahl, schwarz / Textil, weiss, anthrazit
luminaire de table; acier, noir / tissu, blanc, anthracite

L 380, B 185, H 475



E14 2x 40W



9 002759 951948



L 380

H 475



DESIGN
HIGHLIGHT
DETAIL



92755

92755 TOMBOLO

pendant light; steel, satin nickel / fabric with hoop-and-loop tape, creme, taupe, brown

Hängeleuchte; Stahl, nickel-matt / Textil mit Klettverschluss, creme, taupe, braun

luminaire en suspension; acier, nickel mat / tissu avec fermeture velcro, crème, taupe, marron

H 1100, Ø 545



E27 3x 60W



9 002759 927554



94995 MARONDA

floor light; steel, black / fabric, anthracite, white, brown

Stehleuchte; Stahl, schwarz / Textil, anthrazit, weiss, braun

lampadaire; acier, noir / tissu, anthracite, blanc, marron

L 275, B 35, H 1520

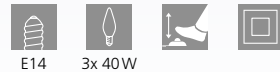

E14 3x 40W



9 002759 949952

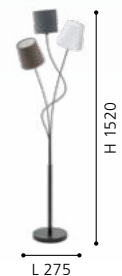



94995

LIGHTING FAMILIES

WOOD LUMINAIRES

HOLZLEUCHTEN

LUMINAIRES À BOIS

SIMPLE CLASSINESS -

The wood luminaires with their unusual designs are perfectly trendy and bring cosiness to every home. Our range of wood luminaires offers a great selection of various shapes, sizes and colours. It contains anything from suspended to table luminaires.

SCHLICHTE ELEGANZ -

Die Holzleuchten mit ihrem außergewöhnlichen Design sind voll im Trend und sorgen für Gemütlichkeit in jedem Zuhause. Unser Sortiment an Holzleuchten bietet eine große Auswahl an verschiedenen Formen, Größen sowie Farben und reicht von der Hänge- bis hin zur Tischleuchte.



ÉLÉGANCE SIMPLE -

Les luminaires en bois avec leur design extraordinaire sont très tendance et assurent un confort dans chaque maison. Notre gamme de luminaires en bois offre un grand choix de formes, de tailles et de couleurs différentes et s'étend des luminaires en suspension jusqu'aux luminaires de table.



WOOD MATERIALS

LAMELLA SHADES



wood, white
Holz, weiss
bois, blanc



wood, brown
Holz, braun
bois, marron



wood, maple
Holz, ahorn
bois, érable



wood, maple
Holz, ahorn
bois, érable

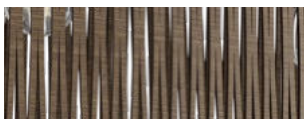

wood, brown
Holz, braun
bois, marron





95599



DESIGN
HIGHLIGHT
DETAIL

95599 STELLATO 1

pendant light; steel, satin nickel / wood, glass, maple, white
Hängeleuchte; Stahl, nickel-matt / Holz, Glas, ahorn, weiss
luminaire en suspension; acier, nickel mat / bois, verre, érable, blanc

H 1500, Ø 500



E27



1x 60W

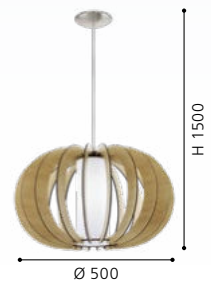



95598 STELLATO 1

pendant light; steel, satin nickel / wood, glass, maple, white
Hängeleuchte; Stahl, nickel-matt / Holz, Glas, ahorn, weiss
luminaire en suspension; acier, nickel mat / bois, verre, érable, blanc

H 1300, Ø 400

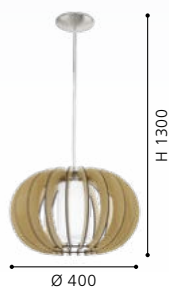
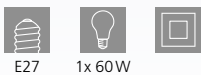

95602 STELLATO 1

wall light; steel, white / wood, glass, maple, white
Wandleuchte; Stahl, weiss / Holz, Glas, ahorn, weiss
applique; acier, blanc / bois, verre, érable, blanc

L 285, H 250, A 140



95597 STELLATO 1

ceiling light; steel, satin nickel / wood, glass, maple, white
Deckenleuchte; Stahl, nickel-matt / Holz, Glas, ahorn, weiss
plafonnier; acier, nickel mat / bois, verre, érable, blanc

H 275, Ø 400

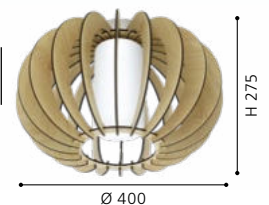



95606 STELLATO 2

pendant light; steel, white / wood, glass, white
 Hängeleuchte; Stahl, weiss / Holz, Glas, weiss
 luminaire en suspension; acier, blanc / bois, verre, blanc

H 1300, Ø 400

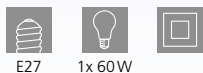

95607 STELLATO 2

pendant light; steel, white / wood, glass, white
 Hängeleuchte; Stahl, weiss / Holz, Glas, weiss
 luminaire en suspension; acier, blanc / bois, verre, blanc

H 1500, Ø 500

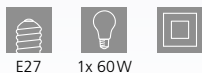

95608 STELLATO 2

pendant light; steel, white / wood, glass, white
 Hängeleuchte; Stahl, weiss / Holz, Glas, weiss
 luminaire en suspension; acier, blanc / bois, verre, blanc

H 2000, Ø 700



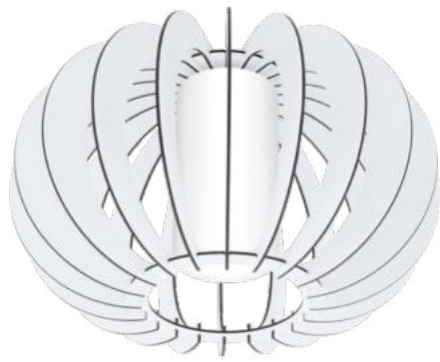

95605



95609



STELLATO 2



DESIGN
HIGHLIGHT
DETAIL

95609 STELLATO 2

wall light; steel, white / wood, glass, white
Wandleuchte; Stahl, weiss / Holz, Glas, weiss
applique; acier, blanc / bois, verre, blanc

L 285, H 250, A 140



E27



1x 60W

95605 STELLATO 2

ceiling light; steel, white / wood, glass, white
Deckenleuchte; Stahl, weiss / Holz, Glas, weiss
plafonnier; acier, blanc / bois, verre, blanc

H 275, Ø 400



E27



1x 60W



9 002759 956097

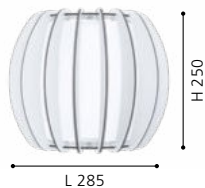

L 285

H 250



9 002759 956059

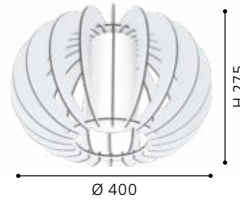

Ø 400

H 275



95591

95592



95593

95591 STELLATO 3

pendant light; steel, satin nickel / wood, glass, brown, white
 Hängeleuchte; Stahl, nickel-matt / Holz, Glas, braun, weiss
 luminaire en suspension; acier, nickel mat / bois, verre, marron, blanc

H 1300, Ø 400

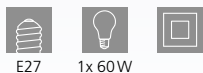

9 002759 955915



95592 STELLATO 3

pendant light; steel, satin nickel / wood, glass, brown, white
 Hängeleuchte; Stahl, nickel-matt / Holz, Glas, braun, weiss
 luminaire en suspension; acier, nickel mat / bois, verre, marron, blanc

H 1500, Ø 500

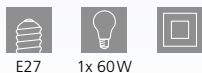

9 002759 955922



95593 STELLATO 3

pendant light; steel, satin nickel / wood, glass, brown, white
 Hängeleuchte; Stahl, nickel-matt / Holz, Glas, braun, weiss
 luminaire en suspension; acier, nickel mat / bois, verre, marron, blanc

H 2000, Ø 700



9 002759 955939





95589



95594



STELLATO 3



DESIGN
HIGHLIGHT
DETAIL

95594 STELLATO 3

wall light; steel, white / wood, glass, brown, white
Wandleuchte; Stahl, weiss / Holz, Glas, braun, weiss
applique; acier, blanc / bois, verre, marron, blanc

L 285, H 250, A 140

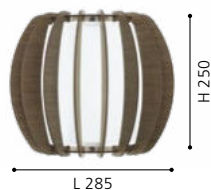

95589 STELLATO 3

ceiling light; steel, satin nickel / wood, glass, brown, white
Deckenleuchte; Stahl, nickel-matt / Holz, Glas, braun, weiss
plafonnier; acier, nickel mat / bois, verre, marron, blanc

H 275, Ø 400

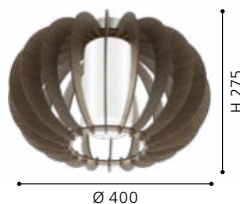



TINDORI

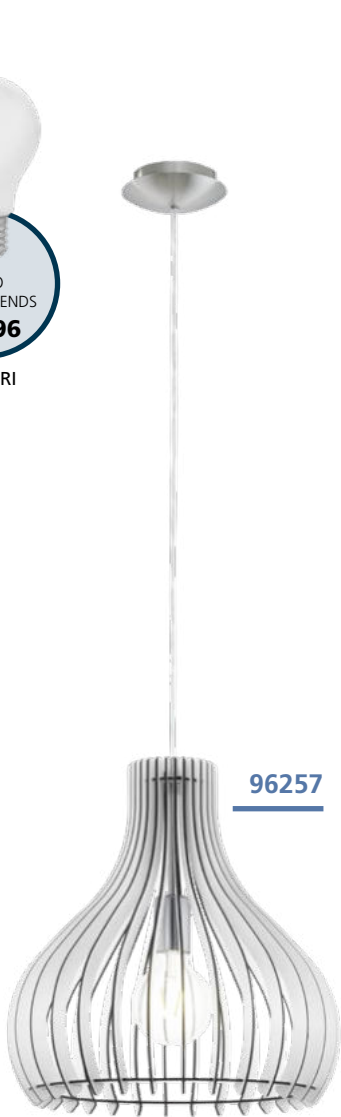

96257



96211



96258

96257 TINDORI

pendant light; steel, satin nickel / wood, white
Hängeleuchte; Stahl, nickel-matt / Holz, weiss
luminaire en suspension; acier, nickel mat / bois, blanc

H 1300, Ø 380



E27 1x 60W



9 002759 962579



96211 TINDORI

pendant light; steel, satin nickel / wood, glass, white
Hängeleuchte; Stahl, nickel-matt / Holz, Glas, weiss
luminaire en suspension; acier, nickel mat / bois, verre, blanc

H 1500, Ø 500



E27 1x 60W



9 002759 962111



96258 TINDORI

pendant light; steel, satin nickel / wood, maple
Hängeleuchte; Stahl, nickel-matt / Holz, ahorn
luminaire en suspension; acier, nickel mat / bois, érable

H 1300, Ø 380



E27 1x 60W



9 002759 962586

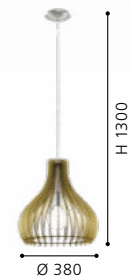



96214



96259



96219

96214 TINDORI

pendant light; steel, satin nickel / wood, glass, maple, white
 Hängeleuchte; Stahl, nickel-matt / Holz, Glas, ahorn, weiss
 luminaire en suspension; acier, nickel mat / bois, verre, érable, blanc

H 1500, Ø 500



9 002759 962142



H 1500

Ø 500

96259 TINDORI

pendant light; steel, satin nickel / wood, brown
 Hängeleuchte; Stahl, nickel-matt / Holz, braun
 luminaire en suspension; acier, nickel mat / bois, marron

H 1300, Ø 380

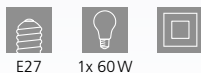

9 002759 962593



H 1300

Ø 380

96219 TINDORI

pendant light; steel, satin nickel / wood, glass, brown, white
 Hängeleuchte; Stahl, nickel-matt / Holz, Glas, braun, weiss
 luminaire en suspension; acier, nickel mat / bois, verre, marron, blanc

H 3000, Ø 800



9 002759 962197



H 3000

Ø 800



94438



94442

94438 COSSANO

pendant light; steel, white / wood, white
 Hängeleuchte; Stahl, weiss / Holz, weiss
 luminaire en suspension; acier, blanc / bois, blanc

H 1300, Ø 300



9 002759 944384



94442 COSSANO

pendant light; steel, white / wood, white
 Hängeleuchte; Stahl, weiss / Holz, weiss
 luminaire en suspension; acier, blanc / bois, blanc

H 1500, Ø 450

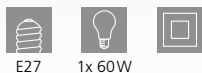

9 002759 944421



94439 COSSANO

pendant light; steel, white / wood, white
 Hängeleuchte; Stahl, weiss / Holz, weiss
 luminaire en suspension; acier, blanc / bois, blanc

H 1500, Ø 500



9 002759 944391





94439



94635



94636



94637

94635 COSSANO

pendant light; steel, satin nickel / wood, brown
 Hängeleuchte; Stahl, nickel-matt / Holz, braun
 luminaire en suspension; acier, nickel mat / bois, marron

H 1300, Ø 300

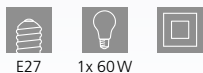

9 002759 946357

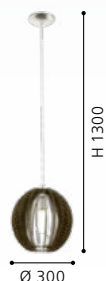

94636 COSSANO

pendant light; steel, satin nickel / wood, brown
 Hängeleuchte; Stahl, nickel-matt / Holz, braun
 luminaire en suspension; acier, nickel mat / bois, marron

H 1500, Ø 500

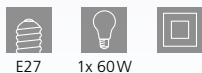

9 002759 946364



94637 COSSANO

pendant light; steel, satin nickel / wood, brown
 Hängeleuchte; Stahl, nickel-matt / Holz, braun
 luminaire en suspension; acier, nickel mat / bois, marron

H 2000, Ø 700



9 002759 946371





94764



94765



94767

94764 COSSANO

pendant light; steel, satin nickel / wood, maple
 Hängeleuchte; Stahl, nickel-matt / Holz, ahorn
 luminaire en suspension; acier, nickel mat / bois, érable

H 1300, Ø 300

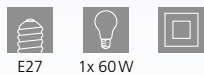

E27 1x 60W



9 002759 947644



94765 COSSANO

pendant light; steel, satin nickel / wood, maple
 Hängeleuchte; Stahl, nickel-matt / Holz, ahorn
 luminaire en suspension; acier, nickel mat / bois, érable

H 1500, Ø 500

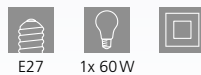

E27 1x 60W



9 002759 947651



94767 COSSANO

pendant light; steel, satin nickel / wood, maple
 Hängeleuchte; Stahl, nickel-matt / Holz, ahorn
 luminaire en suspension; acier, nickel mat / bois, érable

H 1500, Ø 450

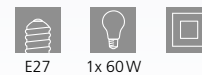

E27 1x 60W



9 002759 947675





95254

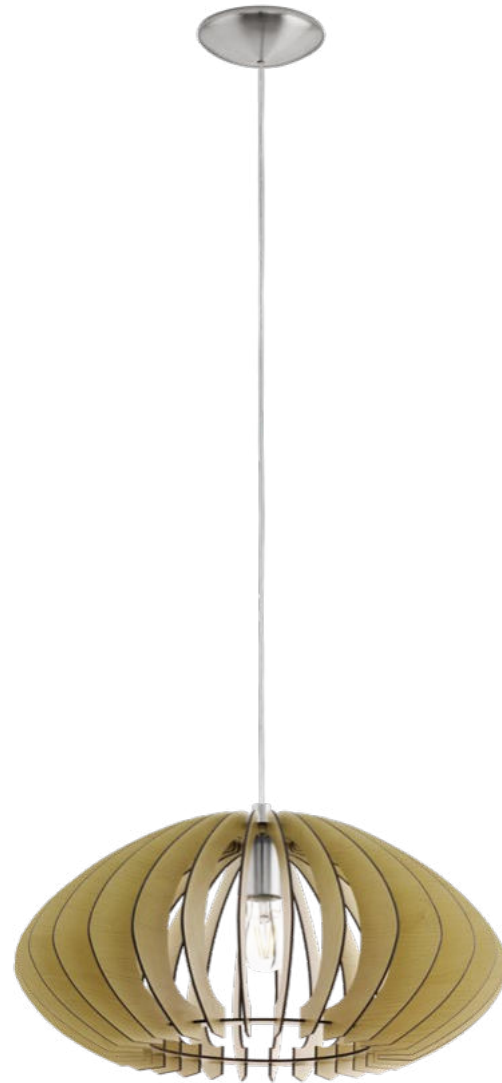

95257

95254 COSSANO 2

pendant light; steel, white / wood, white
 Hängeleuchte; Stahl, weiss / Holz, weiss
 luminaire en suspension; acier, blanc / bois, blanc

H 1500, Ø 500



E27 1x 60W



9 002759 952549



95257 COSSANO 2

pendant light; steel, satin nickel / wood, maple
 Hängeleuchte; Stahl, nickel-matt / Holz, ahorn
 luminaire en suspension; acier, nickel mat / bois, érable

H 1500, Ø 500

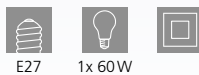

E27 1x 60W



9 002759 952570



95261 COSSANO 2

pendant light; steel, satin nickel / wood, dark brown
 Hängeleuchte; Stahl, nickel-matt / Holz, dunkelbraun
 luminaire en suspension; acier, nickel mat / bois, marron foncé

H 1500, Ø 500

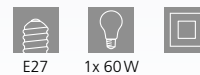

E27 1x 60W



9 002759 952617





95261





96194



96195



96193

96194 SENDERO

pendant light; steel, satin nickel / wood, maple
Hängeleuchte; Stahl, nickel-matt / Holz, ahorn
luminaire en suspension; acier, nickel mat / bois, érable

L 775, B 250, H 1300



E27



2x 60W



9 002759 961947



L 775

H 1300

96193 SENDERO

pendant light; steel, satin nickel / wood, maple
Hängeleuchte; Stahl, nickel-matt / Holz, ahorn
luminaire en suspension; acier, nickel mat / bois, érable

H 1300, Ø 450



E27



1x 60W



9 002759 961930



Ø 450

H 1300

96195 SENDERO

wall light; steel, white / wood, maple
Wandleuchte; Stahl, weiss / Holz, ahorn
applique; acier, blanc / bois, érable

L 240, H 220, A 120



E27



1x 60W



9 002759 961954



A 120

H 220



96199



96201

96199 SENDERO

pendant light; steel, satin nickel / wood, brown
 Hängeleuchte; Stahl, nickel-matt / Holz, braun
 luminaire en suspension; acier, nickel mat / bois, marron

H 1300, Ø 450



9 002759 961992



96201 SENDERO

pendant light; steel, satin nickel / wood, brown
 Hängeleuchte; Stahl, nickel-matt / Holz, braun
 luminaire en suspension; acier, nickel mat / bois, marron

L 775, B 250, H 1300

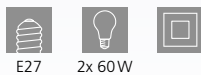

9 002759 962012



LIGHTING FAMILIES

STANDARD LUMINAIRES
STANDARD LEUCHTEN
LUMINAIRES STANDARD

FAMILY MEETING -

This range combines ceiling, wall, suspended, floor and table luminaires. Give your rooms a consistent and stylish all-round illumination.

FAMILIENTREFFEN -

Dieses Sortiment vereint sowohl Decken-, Wand- und Hängeleuchten als auch Tisch- und Stehleuchten. Verleihen Sie Ihren Räumlichkeiten eine einheitliche und stilvolle Rundumbeleuchtung.



RENCONTRE FAMILIALE -

Cette gamme réunit aussi bien des plafonniers, des éclairages muraux, des éclairages suspendus que des lampes de table et des lampadaires. Donnez à vos pièces un éclairage d'ensemble unifié et riche en style.



OVERVIEW

LIGHTING FAMILIES / STANDARD

							
TURALDO p. 196	LIBERTAD p. 198-199	CAMACHO p. 200-201	BOYAL p. 202-205	AZBARREN p. 206	TAREGA p. 208	SILVARES p. 209	CANTERRAS p. 210-211
							
ABREOSA p. 212	CASIBARE p. 214-215	CREMELLA p. 216-217	CORTADERAS p. 218-219	NARICES p. 220-221	ESCANDIDOS p. 222-223	TABIAGO p. 224	ERSEKA p. 226-227
							
CLEMENTE p. 228-229	BONARES 1 p. 230-231	BELESER p. 232-233	GOROSIBA 1 p. 234	GOROSIBA p. 234-235	MANTUNALLE 1 p. 236-237	MANTUNALLE p. 238-239	OPTICA p. 240-243
							
RONDO p. 244-245	VALLASPRA p. 246-247	PINTO TEXTIL p. 248-249	PINTO NERO p. 250	PINTO GOLD p. 252-253	PINTO p. 254-255	TROY 3 p. 256-257	RIVATO p. 258-259
							
BAYMAN p. 259	AMADORA p. 260	BATISTA 3 p. 261	VINOVO p. 262	MURCIA p. 262-263	SAVOY p. 264-265	MARBELLA p. 266-267	ERVIDEL p. 268-269
							
ISIDRO p. 270-271	PALBIETA p. 272-273	PHIANEROS p. 274	EGIDONELLA p. 276-277	ALAMEDILLA p. 278	BANDERILLAS p. 278-279	LEIJAS p. 280-281	LASANA 3 p. 282-283
							
LASANA 2 p. 284-285, 287	LASANA 1 p. 285-287	LASANA p. 286	RONCADE 1 p. 288	SELVINA 1 p. 288	RONCADE p. 289, 296	PAUSIA p. 290	SELVINA p. 290-291



This product is available in different colors and shapes./ Dieser Artikel ist in unterschiedlichen Farben und Formen verfügbar.
Cet article est disponible en différentes couleurs et formes.



VALMORA
p. 292-293



NEVADO
p. 293



PERTINI
p. 294



TARANDELL
p. 295



LAPELA
p. 295



PALOZZA 1
p. 296

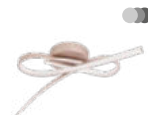

PALOZZA
p. 298-299



NOVAFELTRIA
p. 300-301





DESIGN
HIGHLIGHT
DETAIL



99077



99079

99077 TURALDO

ceiling light; wood, brown
Deckenleuchte; Holz, braun
plafonnier; bois, marron

H 80, Ø 70



E27 1x 28W



9 002759 990770

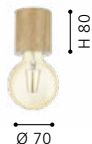

99079 TURALDO

table light; wood, brown
Tischleuchte; Holz, braun
luminaire de table; bois, marron

H 100, Ø 85



E27 1x 28W



9 002759 990794



99078 TURALDO

pendant light; wood, steel, brown, black
Hängeleuchte; Holz, Stahl, braun, schwarz
luminaire en suspension; bois, acier, marron, noir

H 1100, Ø 105



E27 1x 28W



9 002759 990787

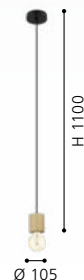



99078

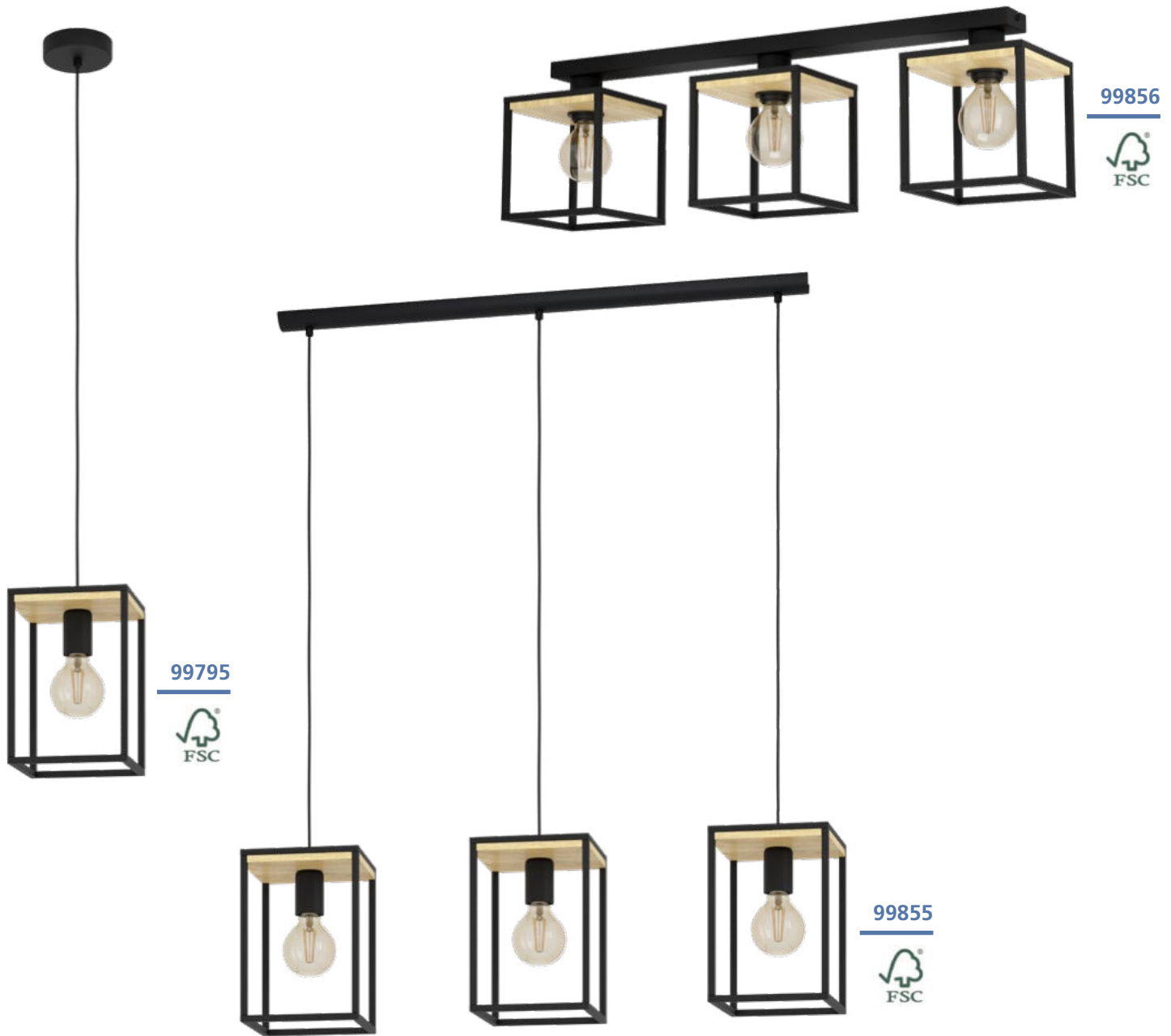

99795 LIBERTAD

pendant light; steel, wood, black, brown
 Hängeleuchte; Stahl, Holz, schwarz, braun
 luminaire en suspension; acier, bois, noir, marron

L 180, B 180, H 1100



E27 1x 40W



9 002759 997953

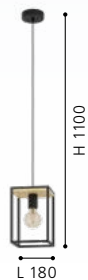

L 180

99855 LIBERTAD

pendant light; steel, wood, black, brown
 Hängeleuchte; Stahl, Holz, schwarz, braun
 luminaire en suspension; acier, bois, noir, marron

L 880, B 180, H 1100



E27 3x 40W



9 002759 998554

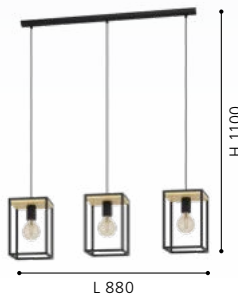

L 880

99856 LIBERTAD

ceiling light; steel, wood, black, brown
 Deckenleuchte; Stahl, Holz, schwarz, braun
 plafonnier; acier, bois, noir, marron

L 860, B 180, H 240



E27 3x 40W



9 002759 998561



L 860



99796



99798



99797



99796 LIBERTAD

wall light; steel, wood, black, brown
Wandleuchte; Stahl, Holz, schwarz, braun
applique; acier, bois, noir, marron

L 140, H 240, A 165



E27 1x 40W



9 002759 997960



99798 LIBERTAD

floor light; steel, wood, black, brown
Stehleuchte; Stahl, Holz, schwarz, braun
lampadaire; acier, bois, noir, marron

L 180, B 180, H 1285



E27 1x 40W



9 002759 997984

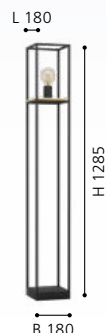

99797 LIBERTAD

table light; steel, wood, black, brown
Tischleuchte; Stahl, Holz, schwarz, braun
luminaire de table; acier, bois, noir, marron

L 140, B 140, H 350



E27 1x 40W



9 002759 997977





99293 CAMACHO

pendant light; steel, wood, black, brown / plastic, white
 Hängeleuchte; Stahl, Holz, schwarz, braun / Kunststoff, weiss
 luminaire en suspension; acier, bois, noir, marron / plastique, blanc

L 1100, B 60, H 1100



25,5W 3100lm



9 002759 992934

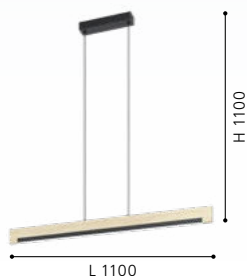

99292 CAMACHO

ceiling light; steel, wood, black, brown / plastic, white
 Deckenleuchte; Stahl, Holz, schwarz, braun / Kunststoff, weiss
 plafonnier; acier, bois, noir, marron / plastique, blanc

L 940, B 80, H 115

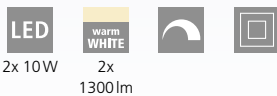

2x 10W 2x 1300lm



9 002759 992927

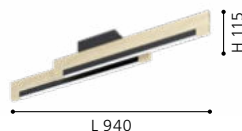

99294 CAMACHO

wall light; steel, wood, black, brown / plastic, white
 Wandleuchte; Stahl, Holz, schwarz, braun / Kunststoff, weiss
 applique; acier, bois, noir, marron / plastique, blanc

L 440, H 105, A 75



1x 8,5W 1x 1050lm



9 002759 992941



TOUCH
ME



99296

LED



99295

LED

99295, 99296

These luminaires can be switched on and off by touching the specially designed "Touch Me" part of the fixture.

Diese Leuchten können ein- und ausgeschaltet werden, indem man sie an den dafür vorgesehenen "Touch Me" Bereichen berührt.

Ces luminaires peuvent être éteints et allumés simplement en touchant la partie spécialement conçue pour "Touch Me" du luminaire.

99296 CAMACHO

floor light; steel, wood, black, brown / plastic, white
Stehleuchte; Stahl, Holz, schwarz, braun / Kunststoff, weiss
lampadaire; acier, bois, noir, marron / plastique, blanc

H 1260, Base: B 250, T 200

LED

22W

warm
WHITE

2400lm



9 002759 992965



99295 CAMACHO

table light; steel, wood, black, brown / plastic, white
Tischleuchte; Stahl, Holz, schwarz, braun / Kunststoff, weiss
luminaire de table; acier, bois, noir, marron / plastique, blanc

H 405, Base: B 150, T 130

LED

1x 6,5W

warm
WHITE

1x
800lm



9 002759 992958





99413



99624



99624 BOYAL

pendant light; steel, wood, black, brown rustic / ceramics, white
 Hängeleuchte; Stahl, Holz, schwarz, braun rustikal / Keramik, weiss
 luminaire en suspension; acier, bois, noir, marron rustique / céramique, blanc

L 1010, B 400, H 1100

12,5W	1800lm	12,5W	1800lm	15,5W

2250lm		



99413 BOYAL

ceiling light; steel, wood, black, brown rustic / plastic, white
 Deckenleuchte; Stahl, Holz, schwarz, braun rustikal / Kunststoff, weiss
 plafonnier; acier, bois, noir, marron rustique / plastique, blanc

L 1010, B 400, H 95

2x 12W	2x 1700lm	1x 12W	1x 1700lm	





99353



99457



99408



99353 BOYAL

wall light; steel, wood, black, brown rustic / plastic, white
Wandleuchte; Stahl, Holz, schwarz, braun rustikal / Kunststoff, weiss
applique; acier, bois, noir, marron rustique / plastique, blanc

L 300, H 560, A 75



9 002759 993535



99457 BOYAL

table light; steel, wood, black, brown rustic / plastic, white
Tischleuchte; Stahl, Holz, schwarz, braun rustikal / Kunststoff, weiss
luminaire de table; acier, bois, noir, marron rustique / plastique, blanc

L 300, B 150, H 425, Base: B 110, T 150

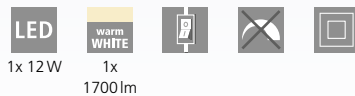

9 002759 994570



99408 BOYAL

ceiling light; steel, wood, black, brown rustic / plastic, white
Deckenleuchte; Stahl, Holz, schwarz, braun rustikal / Kunststoff, weiss
plafonnier; acier, bois, noir, marron rustique / plastique, blanc

L 780, B 400, H 90

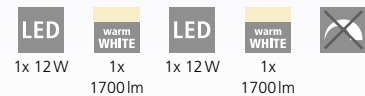

9 002759 994082



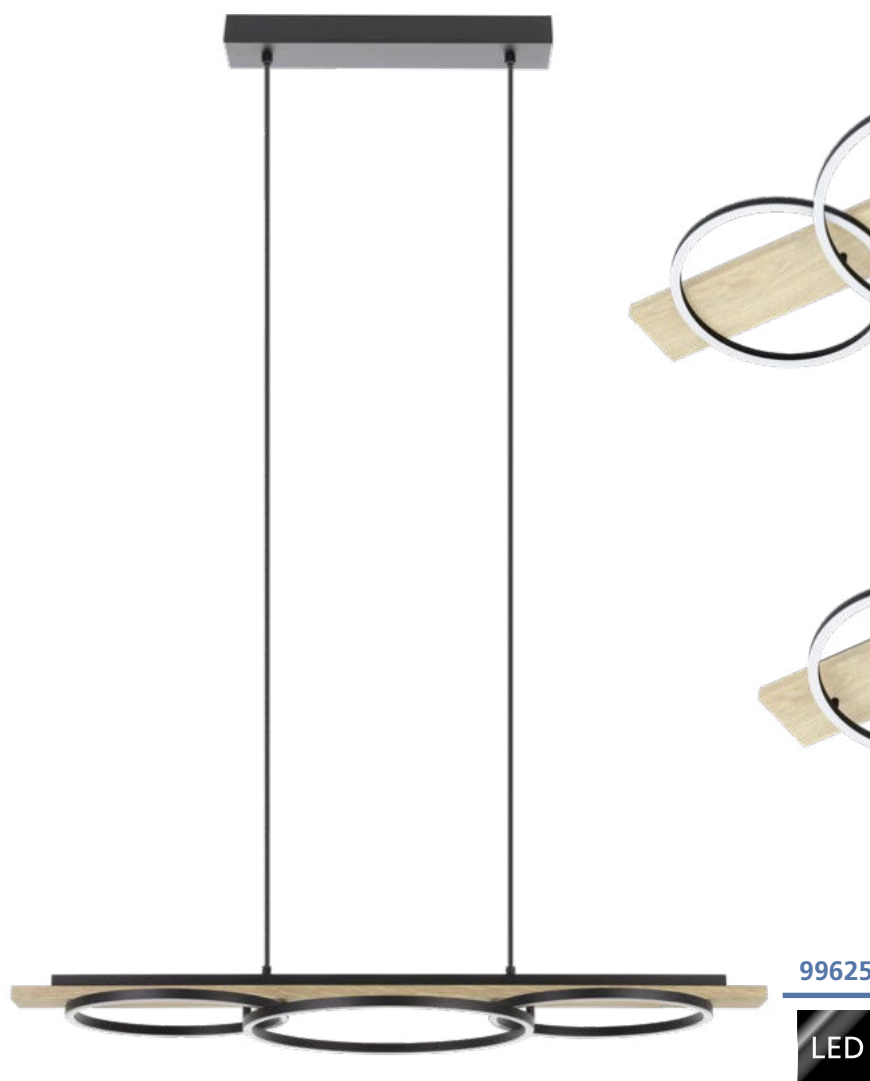

99468

LED

99467

LED

99625

LED

99625 BOYAL

pendant light; steel, black, brown / ceramics, white
 Hängeleuchte; Stahl, schwarz, braun / Keramik, weiss
 luminaire en suspension; acier, noir, marron / céramique, blanc

L 1010, B 400, H 1100

LED 12,5W warm WHITE 1800lm LED 12,5W warm WHITE 1800lm LED 15,5W

warm WHITE 2250lm



9 002759 996253

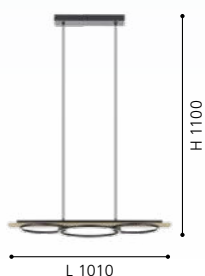

99468 BOYAL

ceiling light; steel, wood, black, brown / plastic, white
 Deckenleuchte; Stahl, Holz, schwarz, braun / Kunststoff, weiss
 plafonnier; acier, bois, noir, marron / plastique, blanc

L 1010, B 400, H 95

LED 2x 12W warm WHITE 1700lm LED 1x 12W warm WHITE 1700lm



9 002759 994686

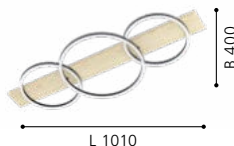

99467 BOYAL

ceiling light; steel, wood, black, brown / plastic, white
 Deckenleuchte; Stahl, Holz, schwarz, braun / Kunststoff, weiss
 plafonnier; acier, bois, noir, marron / plastique, blanc

L 780, B 400, H 90

LED 1x 12W warm WHITE 1700lm LED 1x 12W warm WHITE 1700lm



9 002759 994679

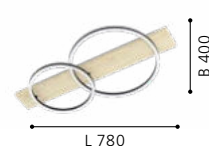



99469

LED



99466

LED

99469 BOYAL

table light; steel, wood, black, brown / plastic, white
Tischleuchte; Stahl, Holz, schwarz, braun / Kunststoff, weiss
luminaire de table; acier, bois, noir, marron / plastique, blanc

L 300, B 150, H 425, Base: B 110, T 150



9 002759 994693



99466 BOYAL

wall light; steel, wood, black, brown / plastic, white
Wandleuchte; Stahl, Holz, schwarz, braun / Kunststoff, weiss
applique; acier, bois, noir, marron / plastique, blanc

L 300, H 560, A 75



9 002759 994662





39753



39752

39753 AZBARREN

table light; steel, beige / ceramics, grey
Tischleuchte; Stahl, beige / Keramik, grau
luminaire de table; acier, beige / céramique, gris

H 535, Ø 300, Base: Ø 145

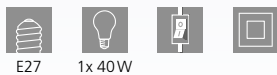

E27 1x 40W



9 002759 397531



39752 AZBARREN

pendant light; steel, beige / ceramics, grey
Hängeleuchte; Stahl, beige / Keramik, grau
luminaire en suspension; acier, beige / céramique, gris

L 1195, B 145, H 1500



E27 4x 40W



9 002759 397524

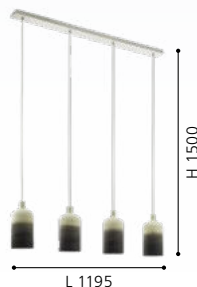

39751 AZBARREN

pendant light; steel, beige / ceramics, grey
Hängeleuchte; Stahl, beige / Keramik, grau
luminaire en suspension; acier, beige / céramique, gris

H 1500, Ø 145



E27 1x 40W



9 002759 397517





39751





95526



95525



95527

95526 TAREGA

pendant light; steel, grey / wood, concrete, brown, grey
 Hängeleuchte; Stahl, grau / Holz, Beton, braun, grau
 luminaire en suspension; acier, gris / bois, béton, marron, gris

H 1500, Ø 250



9 002759 955267



95525 TAREGA

pendant light; steel, grey / wood, concrete, brown, grey
 Hängeleuchte; Stahl, grau / Holz, Beton, braun, grau
 luminaire en suspension; acier, gris / bois, béton, marron, gris

H 1100, Ø 150



9 002759 955250



95527 TAREGA

table light; wood, concrete, brown, grey / fabric, brown
 Tischleuchte; Holz, Beton, braun, grau / Textil, braun
 luminaire de table; bois, béton, marron, gris / tissu, marron

H 370, Ø 250, Base: Ø 150



9 002759 955274





95522



95523



95524

95522 SILVARES

pendant light; steel, grey / concrete, grey
Hängeleuchte; Stahl, grau / Beton, grau
luminaire en suspension; acier, gris / béton, gris

H 1100, Ø 110



E27



1x 60W



9 002759 955229

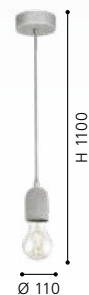

Ø 110

95523 SILVARES

pendant light; steel, grey / concrete, grey
Hängeleuchte; Stahl, grau / Beton, grau
luminaire en suspension; acier, gris / béton, gris

H 1500, Ø 250



E27



3x 60W



9 002759 955236



Ø 250

95524 SILVARES

pendant light; steel, grey / concrete, grey
Hängeleuchte; Stahl, grau / Beton, grau
luminaire en suspension; acier, gris / béton, gris

H 1500, Ø 350



E27



5x 60W



9 002759 955243



Ø 350



99545



99544

99545 CANTERRAS

pendant light; steel, black / terrazzo, grey, white
 Hängeleuchte; Stahl, schwarz / Terrazzo, grau, weiss
 luminaire en suspension; acier, noir / terrazzo, gris, blanc

L 975, B 150, H 1100



99544 CANTERRAS

pendant light; steel, black / terrazzo, grey, white
 Hängeleuchte; Stahl, schwarz / Terrazzo, grau, weiss
 luminaire en suspension; acier, noir / terrazzo, gris, blanc

H 1100, Ø 150

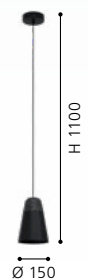
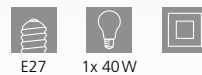



99546



99547



99546 CANTERRAS

wall light; steel, black / terrazzo, grey, white
Wandleuchte; Stahl, schwarz / Terrazzo, grau, weiss
applique; acier, noir / terrazzo, gris, blanc

L 150, H 320, A 275



E27



1x 40W



9 002759 995461



99547 CANTERRAS

floor light; steel, black / terrazzo, grey, white
Stehleuchte; Stahl, schwarz / Terrazzo, grau, weiss
lampadaire; acier, noir / terrazzo, gris, blanc

L 430, B 150, H 1785, Base: Ø 300



E27



1x 40W



9 002759 995478

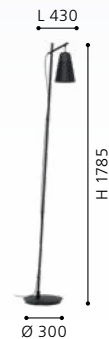



99513



99512

99513 ABREOSA

floor light; steel, black, grey
Stehleuchte; Stahl, schwarz, grau
lampadaire; acier, noir, gris

L 370, B 280, H 1510, Base: Ø 250

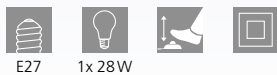

E27 1x 28W



9 002759 995133

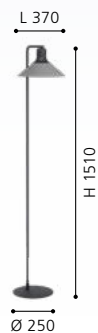

99512 ABREOSA

pendant light; steel, black, grey
Hängeleuchte; Stahl, schwarz, grau
luminaire en suspension; acier, noir, gris

L 1080, B 280, H 1100



E27 3x 28W



9 002759 995126

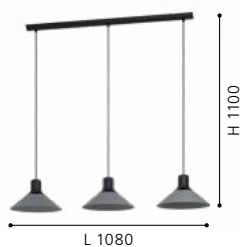

99511 ABREOSA

pendant light; steel, black, grey
Hängeleuchte; Stahl, schwarz, grau
luminaire en suspension; acier, noir, gris

H 1100, Ø 280

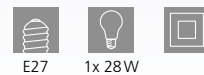

E27 1x 28W



9 002759 995119

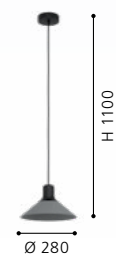



99511





99551 CASIBARE

pendant light; steel, black
 Hängeleuchte; Stahl, schwarz
 luminaire en suspension; acier, noir

H 1100, Ø 150

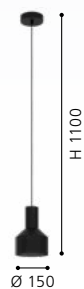

99552 CASIBARE

pendant light; steel, black
 Hängeleuchte; Stahl, schwarz
 luminaire en suspension; acier, noir

L 850, B 150, H 1100

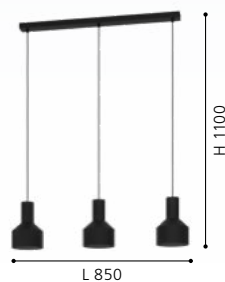

99553 CASIBARE

pendant light; steel, black
 Hängeleuchte; Stahl, schwarz
 luminaire en suspension; acier, noir

H 1500, Ø 710

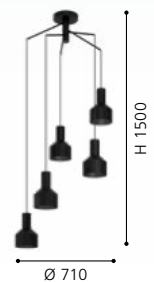



99554



99555

99554 CASIBARE

table light; steel, black
Tischleuchte; Stahl, schwarz
luminaire de table; acier, noir

L 160, B 120, H 490, Base: Ø 155

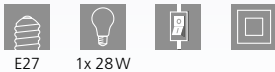

E27 1x 28W



9 002759 995546



99555 CASIBARE

floor light; steel, black
Stehleuchte; Stahl, schwarz
lampadaire; acier, noir

L 350, B 120, H 1605, Base: Ø 250

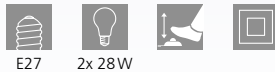

E27 2x 28W



9 002759 995553

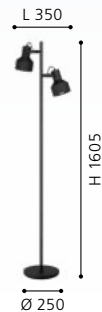



99345



99346

99345 CREMELLA

pendant light; steel, black
 Hängeleuchte; Stahl, schwarz
 luminaire en suspension; acier, noir

H 1100, Ø 370



E27 1x 40W



9 002759 993450



99346 CREMELLA

pendant light; steel, black
 Hängeleuchte; Stahl, schwarz
 luminaire en suspension; acier, noir

H 1100, Ø 180

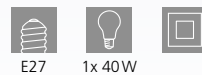

E27 1x 40W



9 002759 993467



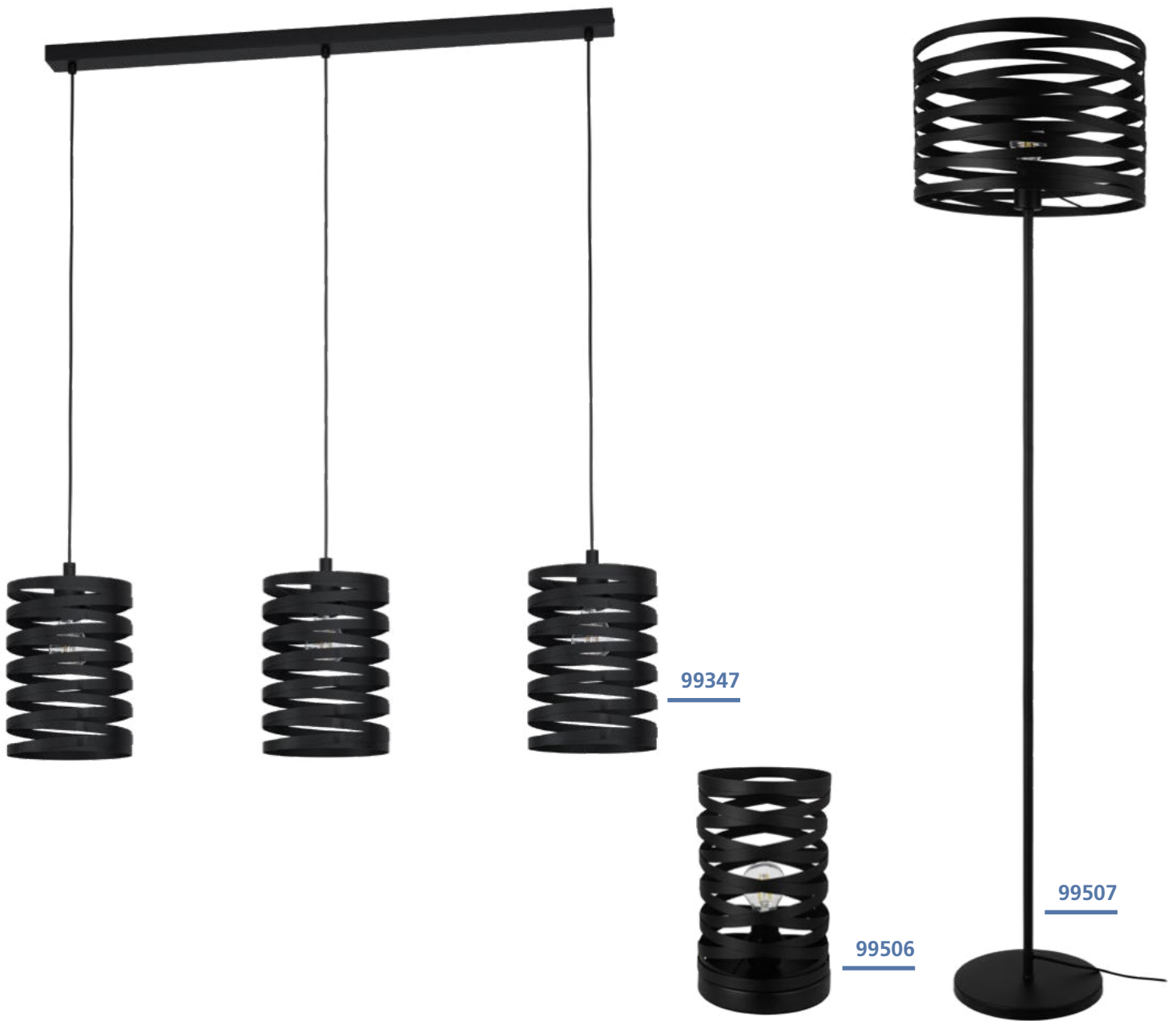

99347 CREMELLA

pendant light; steel, black
 Hängeleuchte; Stahl, schwarz
 luminaire en suspension; acier, noir

L 940, B 180, H 1100

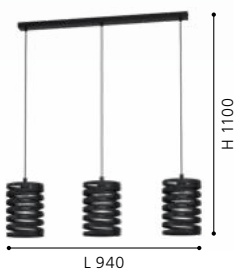

99506 CREMELLA

table light; steel, black
 Tischleuchte; Stahl, schwarz
 luminaire de table; acier, noir

H 290, Ø 180, Base: Ø 180

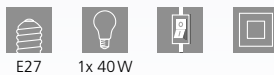

99507 CREMELLA

floor light; steel, black
 Stehleuchte; Stahl, schwarz
 lampadaire; acier, noir

H 1510, Ø 370, Base: Ø 250

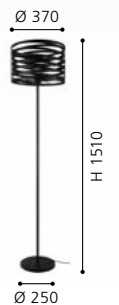
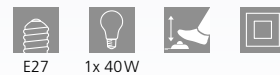

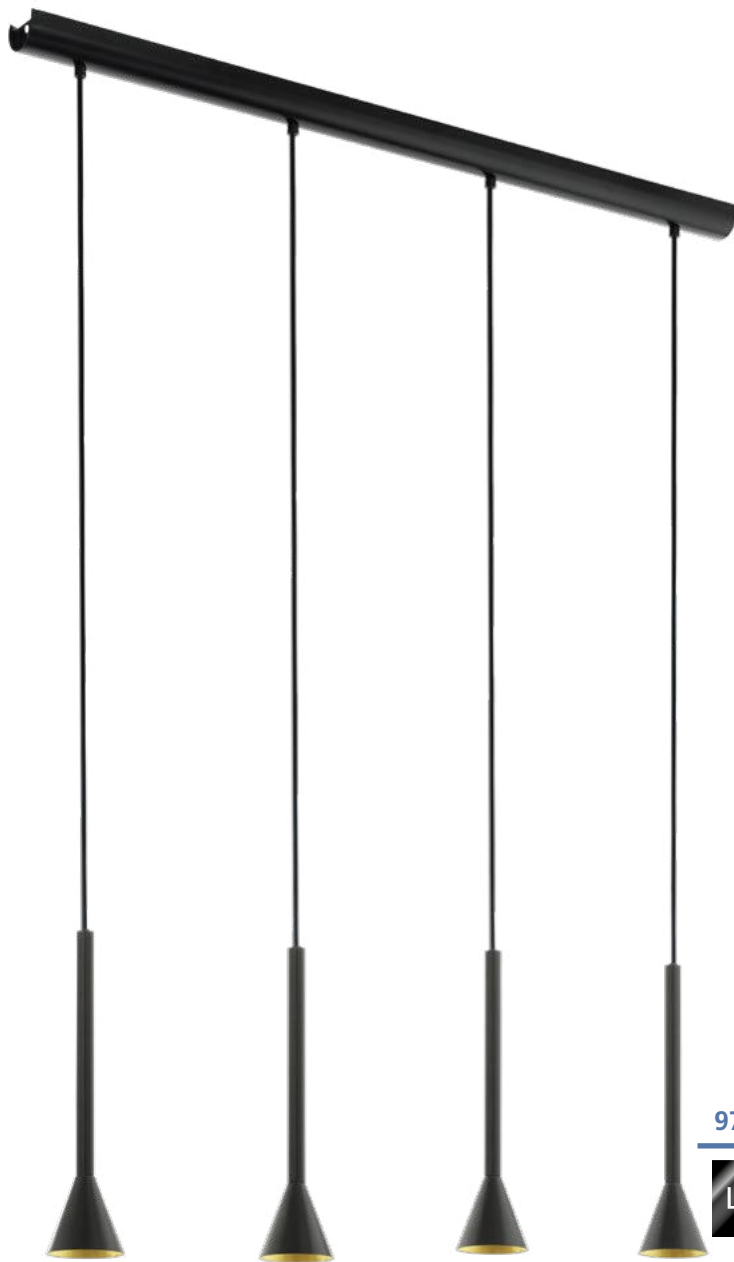

97605



97804



97805



97605 CORTADERAS

pendant light; steel, black, gold
Hängeleuchte; Stahl, schwarz, gold
luminaire en suspension; acier, noir, or

L 1130, B 85, H 1500



GU10



4x 5W



warm
WHITE

4x
400lm

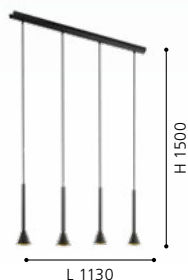

9 002759 976057



97805 CORTADERAS

table light; steel, black, gold
Tischleuchte; Stahl, schwarz, gold
luminaire de table; acier, noir, or

L 235, B 150, H 445, Base: Ø 150



GU10



1x 5W



warm
WHITE

1x
400lm



9 002759 978051



97804 CORTADERAS

wall light; steel, black, gold
Wandleuchte; Stahl, schwarz, gold
applique; acier, noir, or

H 200, Ø 120



GU10



1x 5W



warm
WHITE

1x
400lm



9 002759 978044





97604

LED

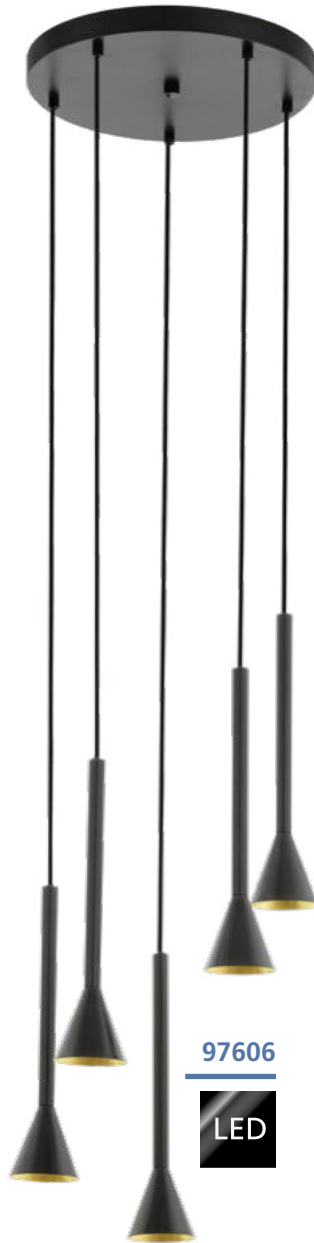

97606

LED



97806

LED

97604 CORTADERAS

pendant light; steel, black, gold
Hängeleuchte; Stahl, schwarz, gold
luminaire en suspension; acier, noir, or

H 1500, Ø 95



GU10



1x 5W



warm
WHITE
1x
400lm



9 002759 976040



H 1500

Ø 95

97606 CORTADERAS

pendant light; steel, black, gold
Hängeleuchte; Stahl, schwarz, gold
luminaire en suspension; acier, noir, or

H 1500, Ø 350



GU10



5x 5W



warm
WHITE
5x
400lm



9 002759 976064



H 1500

Ø 350

97806 CORTADERAS

floor light; steel, black, gold
Stehleuchte; Stahl, schwarz, gold
lampadaire; acier, noir, or

H 1445, Ø 250, Base: Ø 250



GU10



2x 5W



warm
WHITE
2x
400lm



9 002759 978068

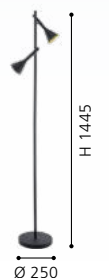

H 1445

Ø 250



99592



DESIGN
HIGHLIGHT
DETAIL

99592 NARICES

pendant light; steel, black / steel, brushed brass, gold
Hängeleuchte; Stahl, schwarz / Stahl, messing-gebürstet, gold
luminaire en suspension; acier, noir / acier, laiton brossé, or

L 920, B 220, H 1100



E27



3x 40W

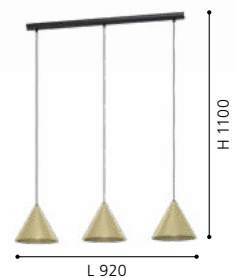



99591



99593



99594

99591 NARICES

pendant light; steel, black / steel, brushed brass, gold
Hängeleuchte; Stahl, schwarz / Stahl, messing-gebürstet, gold
luminaire en suspension; acier, noir / acier, laiton brossé, or

H 1100, Ø 220

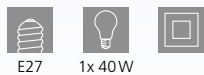

E27 1x 40W



9 002759 995911



99593 NARICES

table light; steel, black / steel, brushed brass, gold
Tischleuchte; Stahl, schwarz / Stahl, messing-gebürstet, gold
luminaire de table; acier, noir / acier, laiton brossé, or

L 295, B 220, H 500, Base: Ø 220



E27 1x 40W



9 002759 995935



99594 NARICES

floor light; steel, black / steel, brushed brass, gold
Stehleuchte; Stahl, schwarz / Stahl, messing-gebürstet, gold
lampadaire; acier, noir / acier, laiton brossé, or

L 295, B 220, H 1620, Base: Ø 270



E27 1x 40W



9 002759 995942

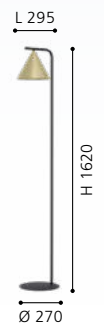



99806



99807



99809

99806 ESCANDIDOS

pendant light; steel, black, brass / steel, black, gold
Hängeleuchte; Stahl, schwarz, messing / Stahl, schwarz, gold
luminaire en suspension; acier, noir, laiton / acier, noir, or

H 1100, Ø 220



E27 1x 40W



9 002759 998066

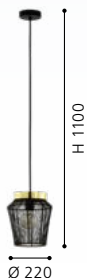

99807 ESCANDIDOS

pendant light; steel, black, brass / steel, black, gold
Hängeleuchte; Stahl, schwarz, messing / Stahl, schwarz, gold
luminaire en suspension; acier, noir, laiton / acier, noir, or

L 920, B 220, H 1100



E27 3x 40W



9 002759 998073



99809 ESCANDIDOS

floor light; steel, black, brass / steel, black, gold
Stehleuchte; Stahl, schwarz, messing / Stahl, schwarz, gold
lampadaire; acier, noir, laiton / acier, noir, or

L 310, B 220, H 1700, Base: B 300, T 200



E27 1x 40W



9 002759 998097

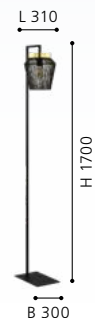



99808

99808 ESCANDIDOS

table light; steel, black, brass / steel, black, gold
Tischleuchte; Stahl, schwarz, messing / Stahl, schwarz, gold
luminaire de table; acier, noir, laiton / acier, noir, or

H 260, Ø 220, Base: Ø 150



E27



1x 40W





99018



99017

99018 TABIAGO

table light; steel, black / steel, rose gold
Tischleuchte; Stahl, schwarz / Stahl, roségold
luminaire de table; acier, noir / acier, or rose

H 300, Ø 130



99017 TABIAGO

pendant light; steel, black / steel, rose gold
Hängeleuchte; Stahl, schwarz / Stahl, roségold
luminaire en suspension; acier, noir / acier, or rose

L 890, B 130, H 1100



99016 TABIAGO

pendant light; steel, black / steel, rose gold
Hängeleuchte; Stahl, schwarz / Stahl, roségold
luminaire en suspension; acier, noir / acier, or rose

H 1100, Ø 130

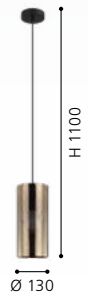
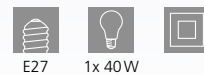



99016



99098



99096



99097

99098 ERSEKA

pendant light; steel, brass / crystal, clear
 Hängeleuchte; Stahl, messing / Kristall, klar
 luminaire en suspension; acier, laiton / cristal, clair

H 1300, Ø 385



E14 5x 40W



99097 ERSEKA

pendant light; steel, brass / crystal, clear
 Hängeleuchte; Stahl, messing / Kristall, klar
 luminaire en suspension; acier, laiton / cristal, clair

H 1450, Ø 485

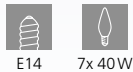

E14 7x 40W



99096 ERSEKA

ceiling light; steel, brass / crystal, clear
 Deckenleuchte; Stahl, messing / Kristall, klar
 plafonnier; acier, laiton / cristal, clair

H 535, Ø 485



E14 7x 40W

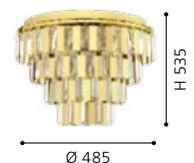



99095



99093



99094



99095 ERSEKA

pendant light; steel, chrome / crystal, clear
Hängeleuchte; Stahl, chrom / Kristall, klar
luminaire en suspension; acier, chrome / cristal, clair

H 1300, Ø 385



99094 ERSEKA

pendant light; steel, chrome / crystal, clear
Hängeleuchte; Stahl, chrom / Kristall, klar
luminaire en suspension; acier, chrome / cristal, clair

H 1450, Ø 485

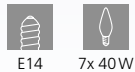

99093 ERSEKA

ceiling light; steel, chrome / crystal, clear
Deckenleuchte; Stahl, chrom / Kristall, klar
plafonnier; acier, chrome / cristal, clair

H 535, Ø 485





95287

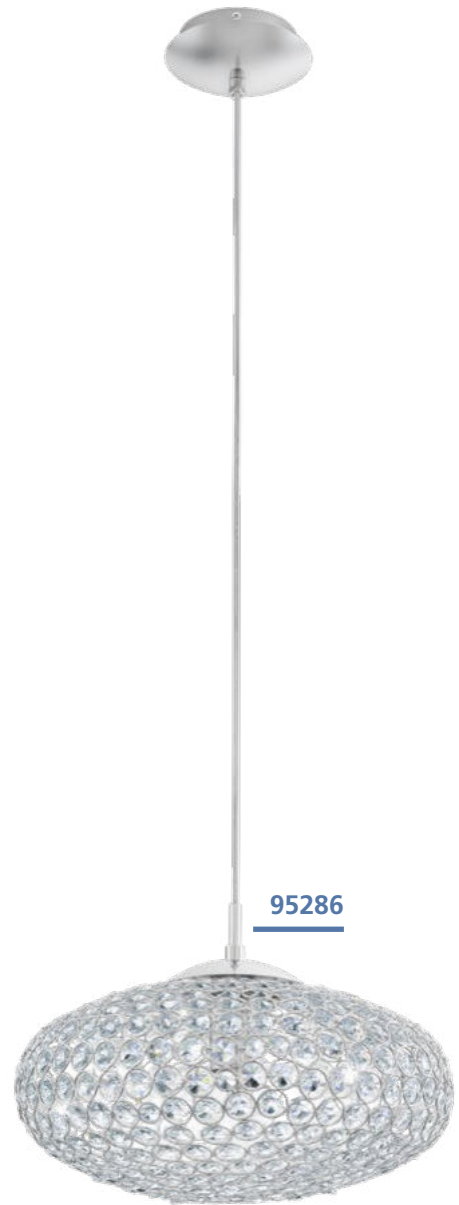

95286



DESIGN
HIGHLIGHT
DETAIL

95287 CLEMENTE

pendant light; steel, chrome / crystal, clear
Hängeleuchte; Stahl, chrom / Kristall, klar
luminaire en suspension; acier, chrome / cristal, clair

H 1100, Ø 540



E27



3x 60W



9 002759 952877

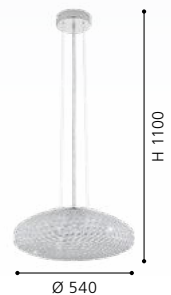



95285



95284

95286 CLEMENTE

pendant light; steel, chrome / crystal, clear
Hängeleuchte; Stahl, chrom / Kristall, klar
luminaire en suspension; acier, chrome / cristal, clair

H 1100, Ø 350



95284 CLEMENTE

ceiling light; steel, chrome / crystal, clear
Deckenleuchte; Stahl, chrom / Kristall, klar
plafonnier; acier, chrome / cristal, clair

H 200, Ø 350

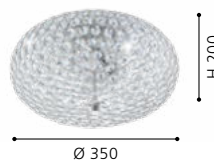

95285 CLEMENTE

ceiling light; steel, chrome / crystal, clear
Deckenleuchte; Stahl, chrom / Kristall, klar
plafonnier; acier, chrome / cristal, clair

H 205, Ø 450

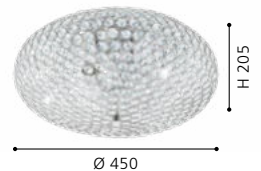



94896



94899



BONARES 1

94896 BONARES 1

pendant light; steel, chrome / steel, crystal, chrome, clear
Hängeleuchte; Stahl, chrom / Stahl, Kristall, chrom, klar
luminaire en suspension; acier, chrome / acier, cristal, chrome, clair

H 1100, Ø 130



E27



1x 60W



9 002759 948962

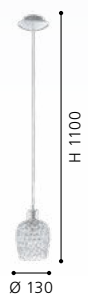

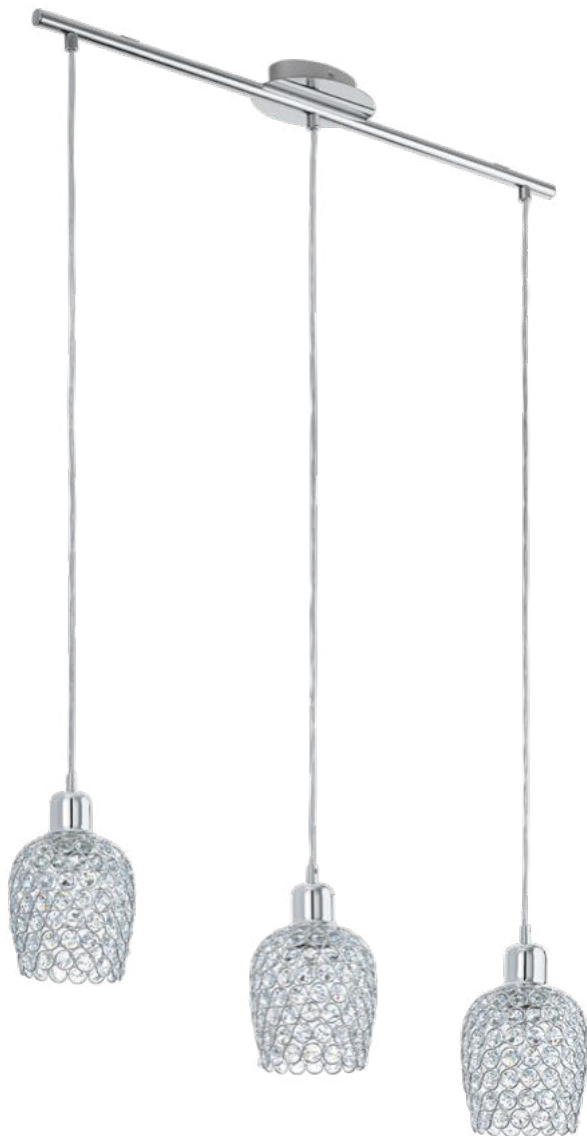

94897



94898

94899 BONARES 1

table light; steel, chrome / steel, crystal, chrome, clear
Tischleuchte; Stahl, chrom / Stahl, Kristall, chrom, klar
luminaire de table; acier, chrome / acier, cristal, chrome, clair

H 190, Ø 130, Base: Ø 120

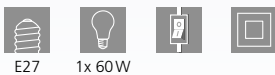

9 002759 948993



94897 BONARES 1

pendant light; steel, chrome / steel, crystal, chrome, clear
Hängeleuchte; Stahl, chrom / Stahl, Kristall, chrom, klar
luminaire en suspension; acier, chrome / acier, cristal, chrome, clair

L 745, B 130, H 1100



9 002759 948979



94898 BONARES 1

pendant light; steel, chrome / steel, crystal, chrome, clear
Hängeleuchte; Stahl, chrom / Stahl, Kristall, chrom, klar
luminaire en suspension; acier, chrome / acier, cristal, chrome, clair

H 1500, Ø 350



9 002759 948986





98384



DESIGN
HIGHLIGHT
DETAIL

98384 BELESER

pendant light; steel, black / glass vaporized, black-transparent
Hängeleuchte; Stahl, schwarz / Glas bedampft, schwarz-transparent
luminaire en suspension; acier, noir / verre vaporisé, noir transparent

L 905, B 205, H 1100



E27



3x 60W



9 002759 983840





98385



BELESER



98386



98387

98385 BELESER

wall light; steel, black / glass vaporized, black-transparent
Wandleuchte; Stahl, schwarz / Glas bedampft, schwarz-transparent
applique; acier, noir / verre vaporisé, noir transparent

L 205, H 270, A 255



E27 1x 60W



9 002759 983857



98386 BELESER

table light; steel, black / glass vaporized, black-transparent
Tischleuchte; Stahl, schwarz / Glas bedampft, schwarz-transparent
luminaire de table; acier, noir / verre vaporisé, noir transparent

L 265, B 205, H 505, Base: Ø 200

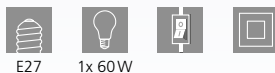

E27 1x 60W



9 002759 983864



98387 BELESER

floor light; steel, black / glass vaporized, black-transparent
Stehleuchte; Stahl, schwarz / Glas bedampft, schwarz-transparent
lampadaire; acier, noir / verre vaporisé, noir transparent

L 260, B 205, H 1505, Base: Ø 220

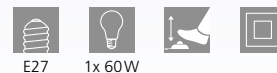

E27 1x 60W



9 002759 983871

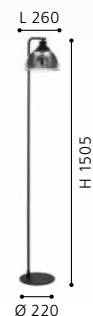



99631



99632



DESIGN
HIGHLIGHT
DETAIL



33984

99631 GOROSIBA 1

ceiling light; steel, black / glass vaporized, black-transparent
Deckenleuchte; Stahl, schwarz / Glas bedampft, schwarz-transparent
plafonnier; acier, noir / verre vaporisé, noir transparent

H 175, Ø 450



E27 3x 40W

99632 GOROSIBA 1

ceiling light; steel, black / glass vaporized, black-transparent
Deckenleuchte; Stahl, schwarz / Glas bedampft, schwarz-transparent
plafonnier; acier, noir / verre vaporisé, noir transparent

L 380, B 380, H 170



E27 4x 40W

33984 GOROSIBA

table light; steel, black / glass vaporized, black-transparent
Tischleuchte; Stahl, schwarz / Glas bedampft, schwarz-transparent
luminaire de table; acier, noir / verre vaporisé, noir transparent

H 220, Ø 150, Base: Ø 100



E27 1x 60W



9 002759 996314



9 002759 996321



9 002759 339845





98752



98752

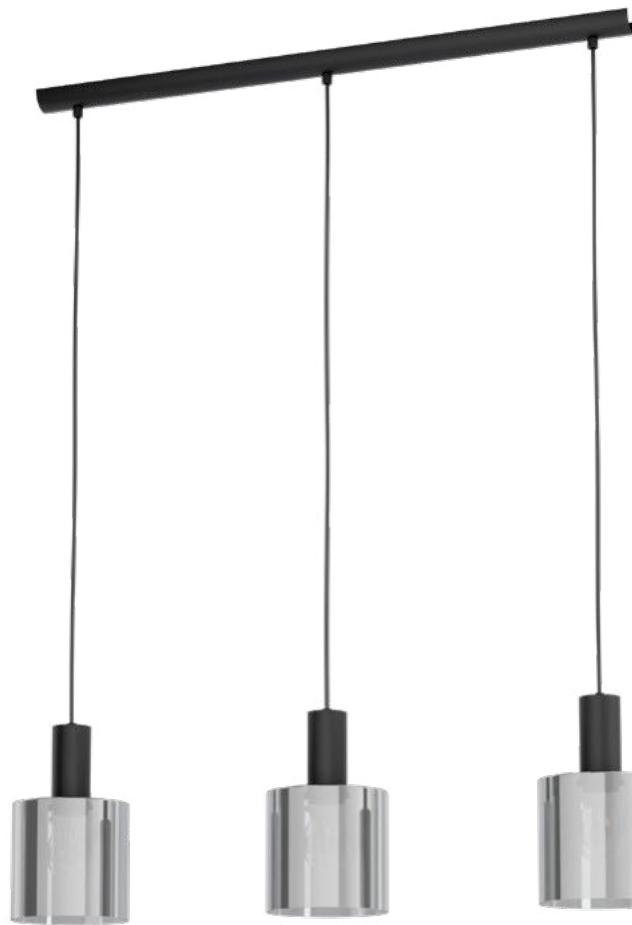

98753



98753 | 98754



98754

98752 GOROSIBA

pendant light; steel, black / glass vaporized, black-transparent
 Hängeleuchte; Stahl, schwarz / Glas bedampft, schwarz-transparent
 luminaire en suspension; acier, noir / verre vaporisé, noir transparent

H 1100, Ø 150



E27 1x 40W



9 002759 987527

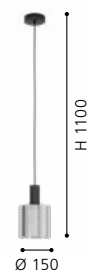

98753 GOROSIBA

pendant light; steel, black / glass vaporized, black-transparent
 Hängeleuchte; Stahl, schwarz / Glas bedampft, schwarz-transparent
 luminaire en suspension; acier, noir / verre vaporisé, noir transparent

L 850, B 150, H 1100



E27 3x 40W



9 002759 987534

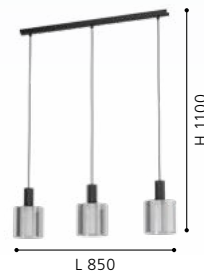

98754 GOROSIBA

pendant light; steel, black / glass vaporized, black-transparent
 Hängeleuchte; Stahl, schwarz / Glas bedampft, schwarz-transparent
 luminaire en suspension; acier, noir / verre vaporisé, noir transparent

H 1300, Ø 410



E27 3x 40W



9 002759 987541

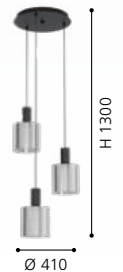



99371 MANTUNALLE 1

pendant light; steel, black / glass vaporized, black-transparent
Hängeleuchte; Stahl, schwarz / Glas bedampft, schwarz-transparent
luminaire en suspension; acier, noir / verre vaporisé, noir transparent

H 1100, Ø 200

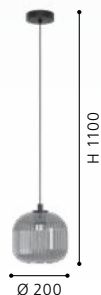

99372 MANTUNALLE 1

pendant light; steel, black / glass vaporized, black-transparent
Hängeleuchte; Stahl, schwarz / Glas bedampft, schwarz-transparent
luminaire en suspension; acier, noir / verre vaporisé, noir transparent

L 1200, B 200, H 1100

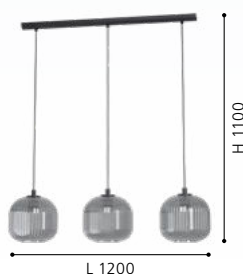

99374 MANTUNALLE 1

table light; steel, black / glass vaporized, black-transparent
Tischleuchte; Stahl, schwarz / Glas bedampft, schwarz-transparent
luminaire de table; acier, noir / verre vaporisé, noir transparent

H 400, Ø 200, Base: Ø 220

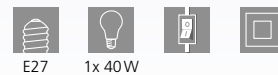



99373

DESIGN
HIGHLIGHT
DETAIL



99373 MANTUNALLE 1

pendant light; steel, black / glass vaporized, black-transparent
Hängeleuchte; Stahl, schwarz / Glas bedampft, schwarz-transparent

luminaire en suspension; acier, noir / verre vaporisé, noir transparent

H 1100, Ø 620



E27



3x 40W



9 002759 993733





99366 MANTUNALLE

pendant light; steel, black / glass, white
 Hängeleuchte; Stahl, schwarz / Glas, weiss
 luminaire en suspension; acier, noir / verre, blanc

H 1100, Ø 200



E27 1x 40W



9 002759 993665

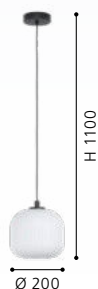

99367 MANTUNALLE

pendant light; steel, black / glass, white
 Hängeleuchte; Stahl, schwarz / Glas, weiss
 luminaire en suspension; acier, noir / verre, blanc

L 1200, B 200, H 1100



E27 3x 40W



9 002759 993672

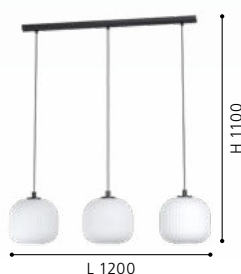

99368 MANTUNALLE

pendant light; steel, black / glass, white
 Hängeleuchte; Stahl, schwarz / Glas, weiss
 luminaire en suspension; acier, noir / verre, blanc

H 1100, Ø 620



E27 3x 40W



9 002759 993689





99368



99367 | 99368 | 99369



99369

99369 MANTUNALLE

table light; steel, black / glass, white
 Tischleuchte; Stahl, schwarz / Glas, weiss
 luminaire de table; acier, noir / verre, blanc

H 400, Ø 200, Base: Ø 220



E27 1x 40W



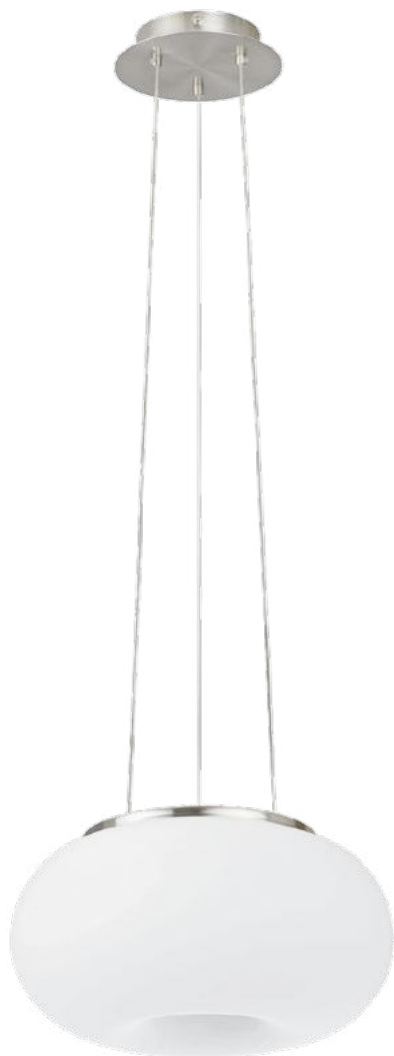

86813



86814



86813 | 86814 | 86815

86813 OPTICA

pendant light; steel, satin nickel / glass opal-matt, white
Hängeleuchte; Stahl, nickel-matt / Glas opal-matt, weiss
luminaire en suspension; acier, nickel mat / verre opale mat, blanc

H 1100, Ø 280



E27



2x 60W



9 002759 868130



86814 OPTICA

pendant light; steel, satin nickel / glass opal-matt, white
Hängeleuchte; Stahl, nickel-matt / Glas opal-matt, weiss
luminaire en suspension; acier, nickel mat / verre opale mat, blanc

H 1100, Ø 350



E27



2x 60W



9 002759 868147



86815 OPTICA

pendant light; steel, satin nickel / glass opal-matt, white
Hängeleuchte; Stahl, nickel-matt / Glas opal-matt, weiss
luminaire en suspension; acier, nickel mat / verre opale mat, blanc

H 1100, Ø 445



E27



2x 60W



9 002759 868154

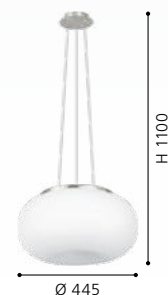



86815



86811



86812



86811 | 86812 | 86816 |
86817



86816

86811 OPTICA

wall / ceiling light; steel, satin nickel / glass opal-matt, white
Wand- / Deckenleuchte; Stahl, nickel-matt / Glas opal-matt, weiss
applique / plafonnier; acier, nickel mat / verre opale mat, blanc

H 160, Ø 280



86812 OPTICA

wall / ceiling light; steel, satin nickel / glass opal-matt, white
Wand- / Deckenleuchte; Stahl, nickel-matt / Glas opal-matt, weiss
applique / plafonnier; acier, nickel mat / verre opale mat, blanc

H 210, Ø 350



86816 OPTICA

table light; steel, satin nickel / glass opal-matt, white
Tischleuchte; Stahl, nickel-matt / Glas opal-matt, weiss
luminaire de table; acier, nickel mat / verre opale mat, blanc

H 460, Ø 280

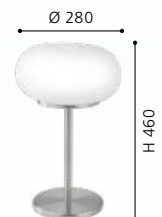
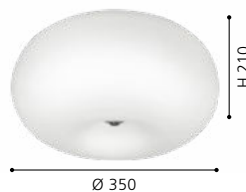
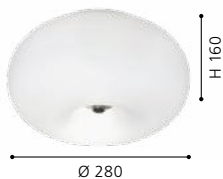
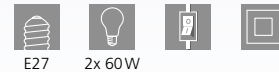



86817 OPTICA

floor light; steel, satin nickel / glass opal-matt, white
Stehleuchte; Stahl, nickel-matt / Glas opal-matt, weiss
lampadaire; acier, nickel mat / verre opale mat, blanc

H 1570, Ø 350



E27



2x 60W



9 002759 868178

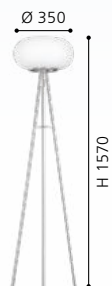

86817



85261



85262

85261 RONDO

pendant light; steel, satin nickel / glass opal-matt, white
 Hängeleuchte; Stahl, nickel-matt / Glas opal-matt, weiss
 luminaire en suspension; acier, nickel mat / verre opale mat, blanc

H 1100, Ø 200



E27 1x 60W



85262 RONDO

pendant light; steel, satin nickel / glass opal-matt, white
 Hängeleuchte; Stahl, nickel-matt / Glas opal-matt, weiss
 luminaire en suspension; acier, nickel mat / verre opale mat, blanc

H 1100, Ø 250



E27 1x 60W

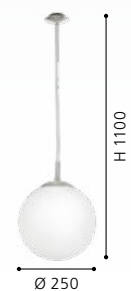



85263 RONDO

pendant light; steel, satin nickel / glass opal-matt, white
Hängeleuchte; Stahl, nickel-matt / Glas opal-matt, weiss
luminaire en suspension; acier, nickel mat / verre opale mat, blanc

H 1100, Ø 300



91589 RONDO

ceiling light; steel, satin nickel / glass opal-matt, white
Deckenleuchte; Stahl, nickel-matt / Glas opal-matt, weiss
plafonnier; acier, nickel mat / verre opale mat, blanc

H 315, Ø 250

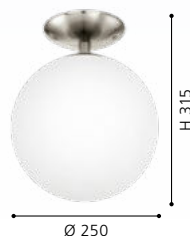

85264 RONDO

table light; plastic, white / glass opal-matt, white
Tischleuchte; Kunststoff, weiss / Glas opal-matt, weiss
luminaire de table; plastique, blanc / verre opale mat, blanc

H 200, Ø 200

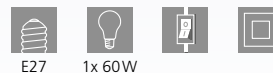



97793 VALLASPRA

pendant light; steel, champagne / glass opal-matt, white
 Hängeleuchte; Stahl, champagner / Glas opal-matt, weiss
 luminaire en suspension; acier, champagne / verre opale mat, blanc

L 910, B 165, H 1100

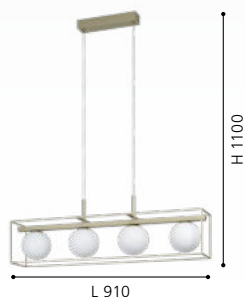
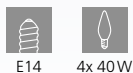

97791 VALLASPRA

wall / ceiling light; steel, champagne / glass opal-matt, white
 Wand- / Deckenleuchte; Stahl, champagner / Glas opal-matt, weiss
 applique / plafonnier; acier, champagne / verre opale mat, blanc

L 165, B 165, H 190

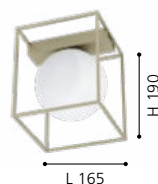

97792 VALLASPRA

wall / ceiling light; steel, champagne / glass opal-matt, white
 Wand- / Deckenleuchte; Stahl, champagner / Glas opal-matt, weiss
 applique / plafonnier; acier, champagne / verre opale mat, blanc

L 350, B 165, H 190





97794 VALLASPRA

table light; steel, champagne / glass opal-matt, white
Tischleuchte; Stahl, champagner / Glas opal-matt, weiss
luminaire de table; acier, champagne / verre opale mat, blanc

L 165, B 165, H 190



E14



1x 40W



9 002759 977948

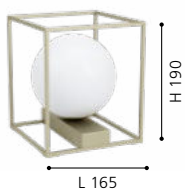

97794



99285 | 99288

99288 PINTO TEXTIL

wall light; steel, satin nickel / glass, fabric, clear, grey
Wandleuchte; Stahl, nickel-matt / Glas, Textil, klar, grau
applique; acier, nickel mat / verre, tissu, clair, gris

L 120, H 445, A 180



99285 PINTO TEXTIL

pendant light; steel, satin nickel / glass, fabric, clear, grey
Hängeleuchte; Stahl, nickel-matt / Glas, Textil, klar, grau
luminaire en suspension; acier, nickel mat / verre, tissu, clair, gris

H 1100, Ø 120

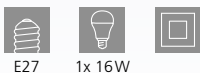

99286 PINTO TEXTIL

pendant light; steel, satin nickel / glass, fabric, clear, grey
Hängeleuchte; Stahl, nickel-matt / Glas, Textil, klar, grau
luminaire en suspension; acier, nickel mat / verre, tissu, clair, gris

L 820, B 120, H 1100





99286 | 99287



99287

99287 PINTO TEXTIL

pendant light; steel, satin nickel / glass, fabric, clear, grey
 Hängeleuchte; Stahl, nickel-matt / Glas, Textil, klar, grau
 luminaire en suspension; acier, nickel mat / verre, tissu, clair, gris

L 945, B 120, H 1100



9 002759 992873





90304



90304 | 90305

90304 PINTO NERO

pendant light; steel, satin nickel / smoked glass, glass opal-matt, black-transparent, white

Hängeleuchte; Stahl, nickel-matt / Rauchglas, Glas opal-matt, schwarz-transparent, weiss

luminaire en suspension; acier, nickel mat / verre fumé, verre opale mat, noir transparent, blanc

H 1100, Ø 110



9 002759 903046



90305 PINTO NERO

pendant light; steel, satin nickel / smoked glass, glass opal-matt, black-transparent, white

Hängeleuchte; Stahl, nickel-matt / Rauchglas, Glas opal-matt, schwarz-transparent, weiss

luminaire en suspension; acier, nickel mat / verre fumé, verre opale mat, noir transparent, blanc

L 725, H 1100



9 002759 903053

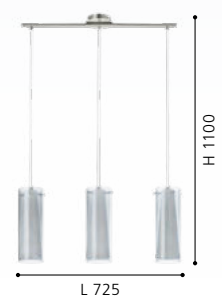



90305



97653



97839

97651

97653 PINTO GOLD

pendant light; steel, black / glass, clear, gold
Hängeleuchte; Stahl, schwarz / Glas, klar, gold
luminaire en suspension; acier, noir / verre, clair, or

L 905, B 360, H 1100



E27



4x 40W

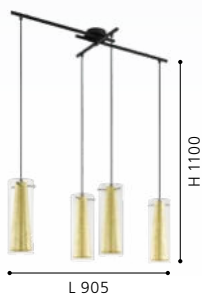

9 002759 976538

97651 PINTO GOLD

pendant light; steel, black / glass, clear, gold
Hängeleuchte; Stahl, schwarz / Glas, klar, gold
luminaire en suspension; acier, noir / verre, clair, or

H 1100, Ø 110



E27



1x 40W



9 002759 976514

97839 PINTO GOLD

wall light; steel, black / glass, clear, gold
Wandleuchte; Stahl, schwarz / Glas, klar, gold
applique; acier, noir / verre, clair, or

L 110, H 270, A 150



E27



1x 40W



9 002759 978396



97652



97655



PINTO GOLD

DESIGN
HIGHLIGHT
DETAIL

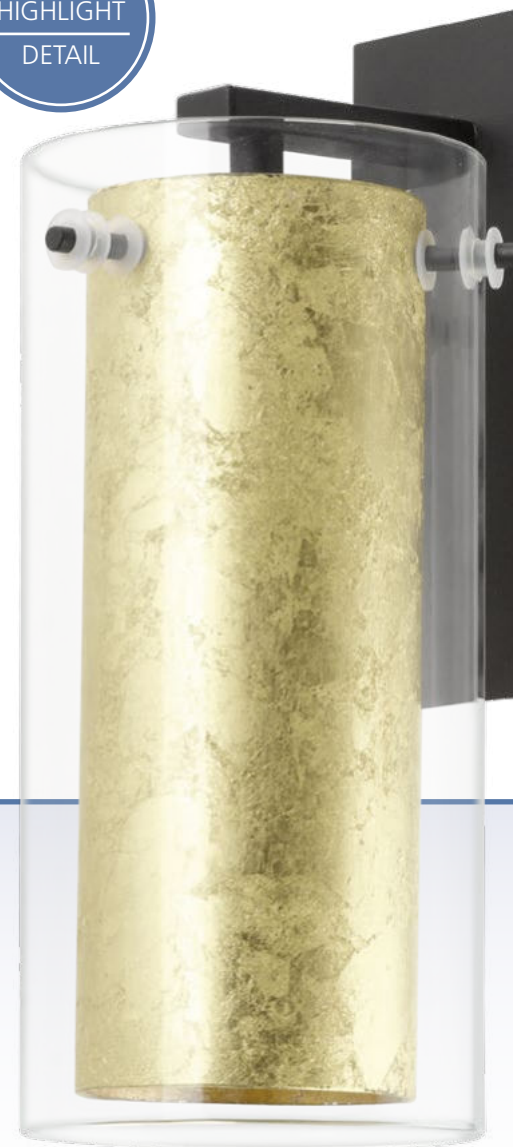

97652 PINTO GOLD

pendant light; steel, black / glass, clear, gold
Hängeleuchte; Stahl, schwarz / Glas, klar, gold
luminaire en suspension; acier, noir / verre, clair, or

L 725, B 110, H 1100

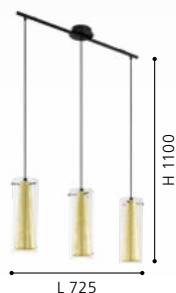

97655 PINTO GOLD

floor light; steel, black, gold / glass, clear, gold
Stehleuchte; Stahl, schwarz, gold / Glas, klar, gold
lampadaire; acier, noir, or / verre, clair, or

H 1470, Ø 110, Base: Ø 230

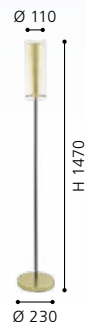
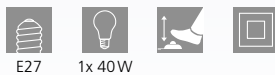

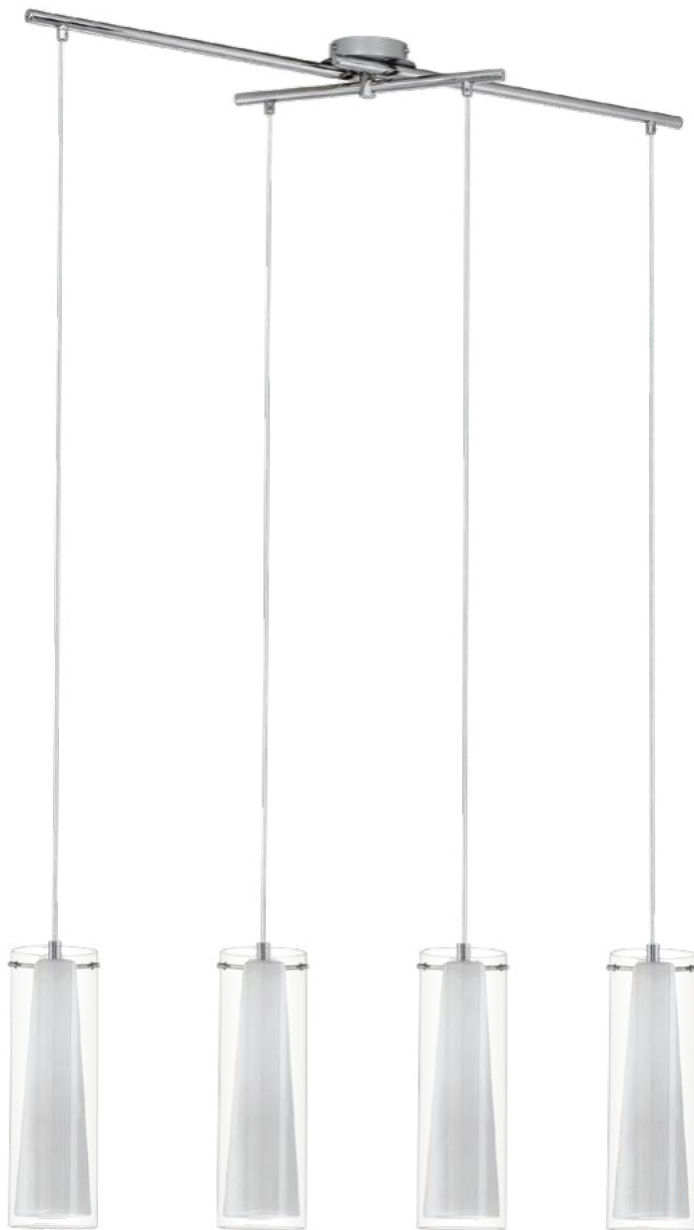

89834



89832 | 89833 | 89834 |
89835 | 89836



89832



89835

89834 PINTO

pendant light; steel, chrome / glass, glass opal-matt, clear, white
Hängeleuchte; Stahl, chrom / Glas, Glas opal-matt, klar, weiss
luminaire en suspension; acier, chrome / verre, verre opale mat, clair, blanc

L 905, B 360, H 1100



E27 4x 40W



9 002759 898342

89835 PINTO

table light; steel, chrome / glass, glass opal-matt, clear, white
Tischleuchte; Stahl, chrom / Glas, Glas opal-matt, klar, weiss
luminaire de table; acier, chrome / verre, verre opale mat, clair, blanc

H 500, Ø 110, Base: Ø 155



E27 1x 40W



9 002759 898359

89832 PINTO

pendant light; steel, chrome / glass, glass opal-matt, clear, white
Hängeleuchte; Stahl, chrom / Glas, Glas opal-matt, klar, weiss
luminaire en suspension; acier, chrome / verre, verre opale mat, clair, blanc

H 1100, Ø 110



E27 1x 40W

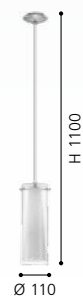

9 002759 898328



93003



89833



89836

93003 PINTO

pendant light; steel, chrome / glass, glass opal-matt, clear, white
 Hängeleuchte; Stahl, chrom / Glas, Glas opal-matt, klar, weiss
 luminaire en suspension; acier, chrome / verre, verre opale mat, clair, blanc

H 1500, Ø 500



E27 5x 40W



9 002759 930035



89833 PINTO

pendant light; steel, chrome / glass, glass opal-matt, clear, white
 Hängeleuchte; Stahl, chrom / Glas, Glas opal-matt, klar, weiss
 luminaire en suspension; acier, chrome / verre, verre opale mat, clair, blanc

L 725, H 1100



E27 3x 40W



9 002759 898335



89836 PINTO

floor light; steel, chrome / glass, glass opal-matt, clear, white
 Stehleuchte; Stahl, chrom / Glas, Glas opal-matt, klar, weiss
 lampadaire; acier, chrome / verre, verre opale mat, clair, blanc

H 1470, Ø 110, Base: Ø 230

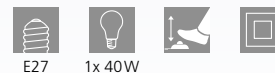

E27 1x 40W



9 002759 898366

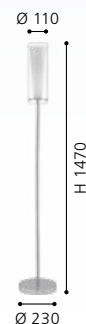



85978



85977

85978 TROY 3

pendant light; steel, satin nickel / satin glass, white painted
 Hängeleuchte; Stahl, nickel-matt / Glas satiniert, weiss lackiert
 luminaire en suspension; acier, nickel mat / verre satiné, blanc laqué

L 720, B 105, H 1100



E27



3x 40W



9 002759 859787

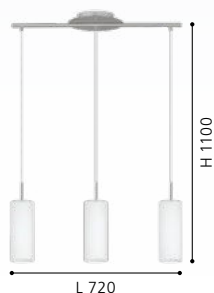

85977 TROY 3

pendant light; steel, satin nickel / satin glass, white painted
 Hängeleuchte; Stahl, nickel-matt / Glas satiniert, weiss lackiert
 luminaire en suspension; acier, nickel mat / verre satiné, blanc laqué

H 1100, Ø 110



E27



1x 40W



9 002759 859770

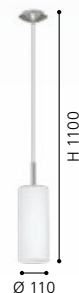

85979 TROY 3

wall light; steel, satin nickel / satin glass, white
 Wandleuchte; Stahl, nickel-matt / Glas satiniert, weiss
 applique; acier, nickel mat / verre satiné, blanc laqué

L 180, H 250, A 75



E14



1x 60W



9 002759 859794





85979



85979



85981



85977 | 85978 | 85981 |
85982

85981 TROY 3

table light; steel, satin nickel / satin glass, white painted
Tischleuchte; Stahl, nickel-matt / Glas satiniert, weiss lackiert
luminaire de table; acier, nickel mat / verre satiné, blanc laqué

H 460, Ø 105, Base: Ø 120



E27 1x 40W



9 002759 859817



85982 TROY 3

floor light; steel, satin nickel / satin glass, white painted
Stehleuchte; Stahl, nickel-matt / Glas satiniert, weiss lackiert
lampadaire; acier, nickel mat / verre satiné, blanc laqué

H 1530, Ø 105, Base: Ø 200



E27 1x 40W



9 002759 859824

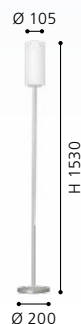

85982

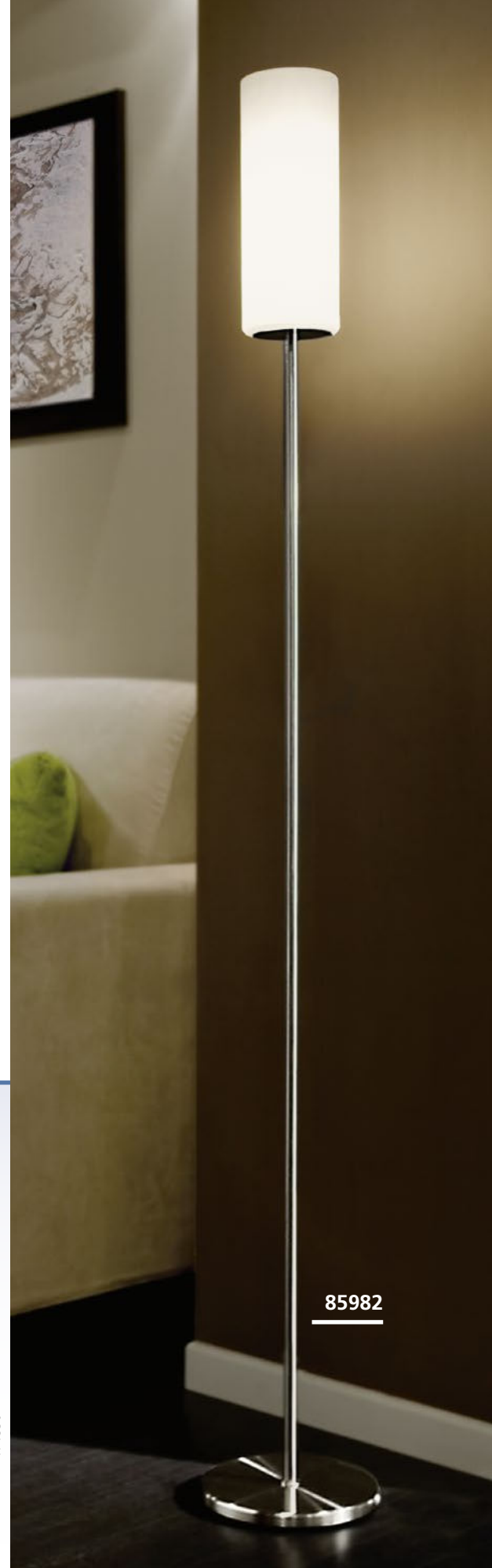



92739



92742



92742

92741

92739 RIVATO

pendant light; steel, chrome / glass with decor, white, chrome
Hängeleuchte; Stahl, chrom / Glas mit Dekor, weiss, chrom
luminaire en suspension; acier, chrome / verre avec décor, blanc, chrome

H 1100, Ø 90



E27



1x 60W



9 002759 927394

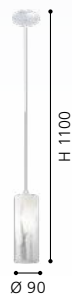

92741 RIVATO

pendant light; steel, chrome / glass with decor, white, chrome
Hängeleuchte; Stahl, chrom / Glas mit Dekor, weiss, chrom
luminaire en suspension; acier, chrome / verre avec décor, blanc, chrome

L 705, B 90, H 1100



E27



3x 60W



9 002759 927417



92742 RIVATO

wall light; steel, white, chrome / glass with decor, white, chrome
Wandleuchte; Stahl, weiss, chrom / Glas mit Dekor, weiss, chrom
applique; acier, blanc, chrome / verre avec décor, blanc, chrome

L 180, H 250, A 80



E14



1x 42W



9 002759 927424





91971 | 92563 | 92739 |
92741 | 92743



92743



92563

91971

92743 RIVATO

table light; glass with decor, white, chrome
Tischleuchte; Glas mit Dekor, weiss, chrom
luminaire de table; verre avec décor, blanc, chrome

H 260, Ø 90

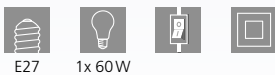

E27 1x 60W



9 002759 927431



92563 BAYMAN

pendant light; steel, chrome / glass with decor, white, chrome
Hängeleuchte; Stahl, chrom / Glas mit Dekor, weiss, chrom
luminaire en suspension; acier, chrome / verre avec décor, blanc, chrome

L 720, B 105, H 1100



E27 3x 60W



9 002759 925635



91971 BAYMAN

table light; glass with decor, white, chrome
Tischleuchte; Glas mit Dekor, weiss, chrom
luminaire de table; verre avec décor, blanc, chrome

H 270, Ø 105

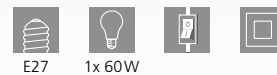

E27 1x 60W



9 002759 919719





90048



90049



90049

90048 AMADORA

pendant light; steel, satin nickel / glass printed, white
 Hängeleuchte; Stahl, nickel-matt / Glas bedruckt, weiss
 luminaire en suspension; acier, nickel mat / verre imprimé, blanc

L 720, B 105, H 1100



E27



3x 60W



9 002759 900489



L 720

H 1100

90049 AMADORA

wall light; steel, satin nickel / glass printed, white
 Wandleuchte; Stahl, nickel-matt / Glas bedruckt, weiss
 applique; acier, nickel mat / verre imprimé, blanc

L 180, H 250, A 75



E14



1x 60W



9 002759 900496



L 180

H 250



97587



97589



90048 | 97587 | 97589

BATISTA 3

These luminaires come with a hand-made glass with a special wipe technique.

Diese Leuchten sind aus handgemachtem Glas mit spezieller Wischtechnik.

Ces luminaires viennent avec un verre de luxe fait main avec une technique à l'essuyé.



97587 BATISTA 3

pendant light; steel, satin nickel / glass wiping technique, white
Hängeleuchte; Stahl, nickel-matt / Glas Wischtechnik, weiss
luminaire en suspension; acier, nickel mat / technique d'essuie de verre, blanc

L 1020, B 120, H 1100



9 002759 975876



97589 BATISTA 3

table light; steel, satin nickel / glass wiping technique, white
Tischleuchte; Stahl, nickel-matt / Glas Wischtechnik, weiss
luminaire de table; acier, nickel mat / technique d'essuie de verre, blanc

H 225, Ø 120, Base: Ø 110



9 002759 975890





91433



91002



91004

91433 VINOVO

pendant light; steel, dark brown / glass alabaster, white
 Hängeleuchte; Stahl, dunkelbraun / Glas alabaster, weiss
 luminaire en suspension; acier, marron foncé / verre albâtre, blanc

L 770, B 250, H 1100



E27

2x 60W



9 002759 914332



L 770

H 1100

91002 MURCIA

pendant light; steel, black / glass alabaster, white
 Hängeleuchte; Stahl, schwarz / Glas alabaster, weiss
 luminaire en suspension; acier, noir / verre albâtre, blanc

H 1100, Ø 380



E27

1x 60W



9 002759 910020



Ø 380

H 1100

91004 MURCIA

pendant light; steel, black / glass alabaster, white
 Hängeleuchte; Stahl, schwarz / Glas alabaster, weiss
 luminaire en suspension; acier, noir / verre albâtre, blanc

L 680, H 1100



E27

2x 60W



9 002759 910044



L 680

H 1100



91005



91006



91007



MURCIA, VINOVO

These luminaires come with high quality processed alabaster glass.

Diese Leuchten sind mit hochwertigem Alabasterglas ausgestattet.

Ces luminaires viennent avec un abat-jour en verre d'albâtre haut de gamme.

91005 MURCIA

pendant light; steel, black / glass alabaster, white
Hängeleuchte; Stahl, schwarz / Glas alabaster, weiss
luminaire en suspension; acier, noir / verre albâtre, blanc

H 1100, Ø 630



E27 3x 60W



9 002759 910051

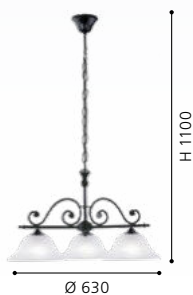

91006 MURCIA

wall light; steel, black / glass alabaster, white
Wandleuchte; Stahl, schwarz / Glas alabaster, weiss
applique; acier, noir / verre albâtre, blanc

L 165, H 190, A 230



E14 1x 40W



9 002759 910068



91007 MURCIA

table light; steel, black / glass alabaster, white
Tischleuchte; Stahl, schwarz / Glas alabaster, weiss
luminaire de table; acier, noir / verre albâtre, blanc

L 165, H 370, Base: Ø 150



E14 1x 40W



9 002759 910075





82748



82749



DESIGN
HIGHLIGHT
DETAIL

82748 SAVOY

pendant light; cast metal, bronzed / satin glass, white
Hängeleuchte; Metallguss, brüniert / Glas satiniert, weiss
luminaire en suspension; fonte métallique, bruni / verre satiné, blanc

H 1100, Ø 740



9 002759 827489



82749 SAVOY

pendant light; cast metal, bronzed / satin glass, white
Hängeleuchte; Metallguss, brüniert / Glas satiniert, weiss
luminaire en suspension; fonte métallique, bruni / verre satiné, blanc

H 1100, Ø 740



9 002759 827496





82751



82752



82747

82751 SAVOY

wall light; cast metal, bronzed / satin glass, white
 Wandleuchte; Metallguss, brüniert / Glas satiniert, weiss
 applique; fonte métallique, bruni / verre satiné, blanc

L 180, H 160, A 240

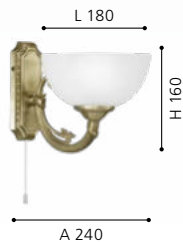

82752 SAVOY

wall light; cast metal, bronzed / satin glass, white
 Wandleuchte; Metallguss, brüniert / Glas satiniert, weiss
 applique; fonte métallique, bruni / verre satiné, blanc

L 410, H 160, A 210

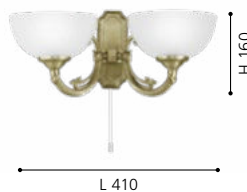

82747 SAVOY

pendant light; cast metal, bronzed / satin glass, white
 Hängeleuchte; Metallguss, brüniert / Glas satiniert, weiss
 luminaire en suspension; fonte métallique, bruni / verre satiné, blanc

H 1100, Ø 310

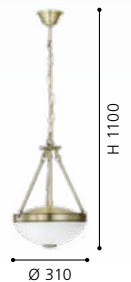



85856



85857



85859

85856 MARBELLA

ceiling light; cast metal, bronzed / glass alabaster, champagne
Deckenleuchte; Metallguss, brüniert / Glas alabaster, champagner
plafonnier; fonte métallique, bruni / verre albâtre, champagne

H 410, Ø 370



E14 3x 60W



9 002759 858568

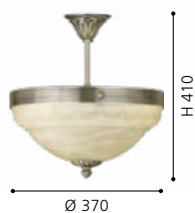

85857 MARBELLA

pendant light; cast metal, bronzed / glass alabaster, champagne
Hängeleuchte; Metallguss, brüniert / Glas alabaster, champagner
luminaire en suspension; fonte métallique, bruni / verre albâtre, champagne

H 1100, Ø 740



E14 6x 60W



9 002759 858575



85859 MARBELLA

wall light; cast metal, bronzed / glass alabaster, champagne
Wandleuchte; Metallguss, brüniert / Glas alabaster, champagner
applique; fonte métallique, bruni / verre albâtre, champagne

L 170, H 200, A 230

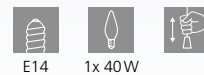

E14 1x 40W



9 002759 858599





85858

85858 MARBELLA

pendant light; cast metal, bronzed / glass alabaster, champagne
Hängeleuchte; Metallguss, brüniert / Glas alabaster, champagner
luminaire en suspension; fonte métallique, bruni / verre albâtre, champagne

H 1100, Ø 740



E14 9x60W



9 002759 858582

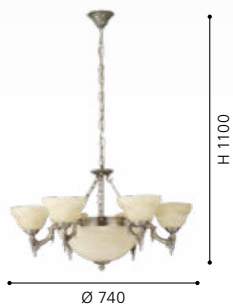

MARBELLA

These luminaires come with high quality processed alabaster glass.

Diese Leuchten sind mit hochwertigem Alabasterglas ausgestattet.

Ces luminaires viennent avec un abat-jour en verre d'albâtre haut de gamme.





98876 ERVIDEL

pendant light; steel, black / plastic, satined, clear
 Hängeleuchte; Stahl, schwarz / Kunststoff, satiniert, klar
 luminaire en suspension; acier, noir / plastique, satiné, clair

L 930, B 60, H 1100

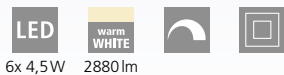

6x 4,5W 2880lm

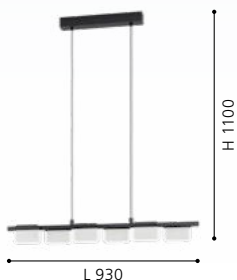

98874 ERVIDEL

ceiling light; steel, black / plastic, satined, clear
 Deckenleuchte; Stahl, schwarz / Kunststoff, satiniert, klar
 plafonnier; acier, noir / plastique, satiné, clair

L 625, B 60, H 160



4x 4,5W 1920lm



98875 ERVIDEL

ceiling light; steel, black / plastic, satined, clear
 Deckenleuchte; Stahl, schwarz / Kunststoff, satiniert, klar
 plafonnier; acier, noir / plastique, satiné, clair

L 930, B 60, H 160

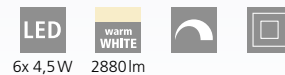

6x 4,5W 2880lm





98878

LED



98877

LED

98878 ERVIDEL

table light; steel, black / plastic, satined, clear
Tischleuchte; Stahl, schwarz / Kunststoff, satiniert, klar
luminaire de table; acier, noir / plastique, satiné, clair

L 155, B 60, H 500, Base: B 180, T 180



2x 4,5W 960lm



98877 ERVIDEL

wall light; steel, black / plastic, satined, clear
Wandleuchte; Stahl, schwarz / Kunststoff, satiniert, klar
applique; acier, noir / plastique, satiné, clair

L 320, H 90, A 80



2x 4,5W 960lm





99562

LED

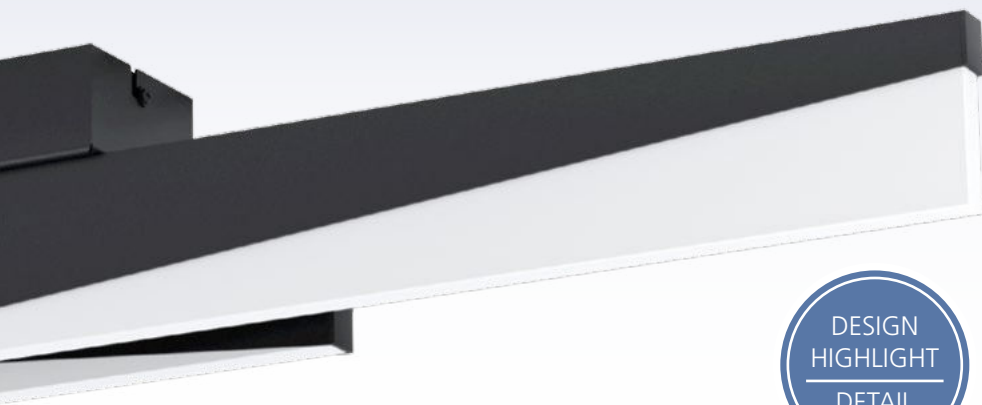

DESIGN
HIGHLIGHT
DETAIL

99562 ISIDRO

pendant light; aluminium, steel, black / plastic, satined
Hängeleuchte; Alu, Stahl, schwarz / Kunststoff, satiniert
luminaire en suspension; aluminium, acier, noir / plastique, satiné

L 795, B 60, H 1100

LED
27W

warm
WHITE
3850lm

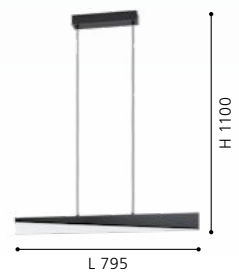



99561



99563



99564



99561 ISIDRO

ceiling light; aluminium, steel, black / plastic, satiné
Deckenleuchte; Alu, Stahl, schwarz / Kunststoff, satiniert
plafonnier; aluminium, acier, noir / plastique, satiné

L 860, B 80, H 110



2x 11 W 2700lm



9 002759 995614



99563 ISIDRO

wall light; aluminium, steel, black / plastic, satiné
Wandleuchte; Alu, Stahl, schwarz / Kunststoff, satiniert
applique; aluminium, acier, noir / plastique, satiné

L 395, H 80, A 70



9 W 1050lm



9 002759 995638



99564 ISIDRO

table light; aluminium, steel, black / plastic, satiné
Tischleuchte; Alu, Stahl, schwarz / Kunststoff, satiniert
luminaire de table; aluminium, acier, noir / plastique, satiné

H 410, Base: B 150, T 130



9 W 1050lm



9 002759 995645

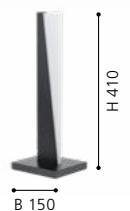



99013
LED

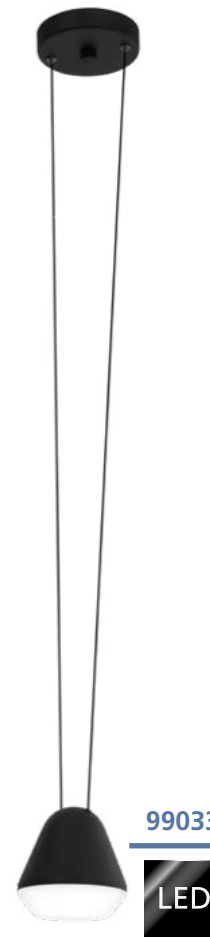



99033
LED



99013 PALBIETA

pendant light; steel, black / plastic, clear, satined
Hängeleuchte; Stahl, schwarz / Kunststoff, klar, satiniert
luminaire en suspension; acier, noir / plastique, clair, satiné

L 1160, B 115, H 1100

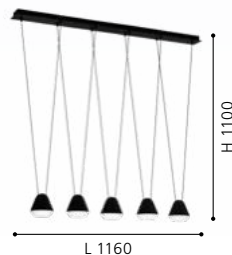

-  GU10
-  5x 3W
-  warm WHITE
5x 240lm



99033 PALBIETA

pendant light; steel, black / plastic, clear, satined
Hängeleuchte; Stahl, schwarz / Kunststoff, klar, satiniert
luminaire en suspension; acier, noir / plastique, clair, satiné

H 1100, Ø 115

-  GU10
-  1x 3W
-  warm WHITE
1x 240lm

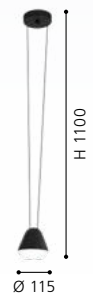



99034

LED

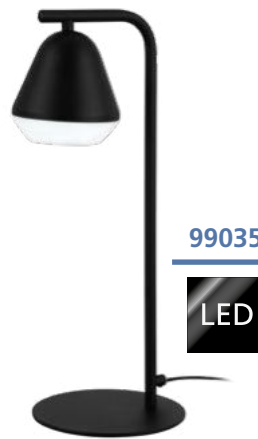

99035

LED

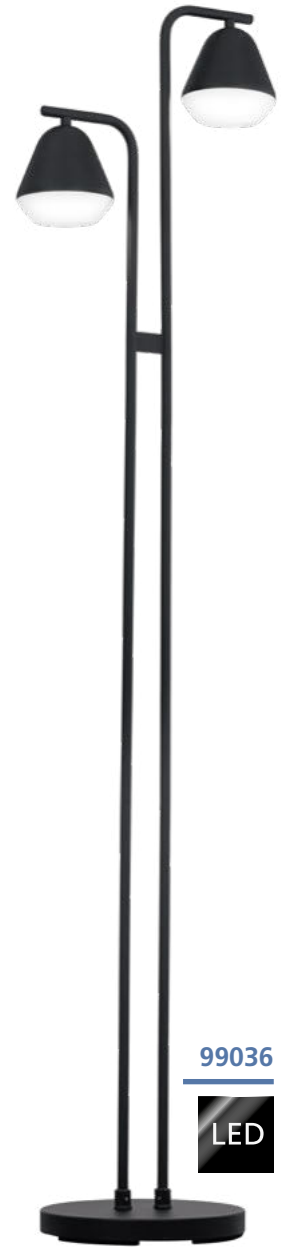

99036

LED

99034 PALBIETA

wall light; steel, black / plastic, clear, satiné
Wandleuchte; Stahl, schwarz / Kunststoff, klar, satiniert
applique; acier, noir / plastique, clair, satiné

L 115, H 275, A 185

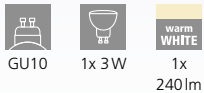

99035 PALBIETA

table light; steel, black / plastic, clear, satiné
Tischleuchte; Stahl, schwarz / Kunststoff, klar, satiniert
luminaire de table; acier, noir / plastique, clair, satiné

L 190, B 170, H 445, Base: Ø 170

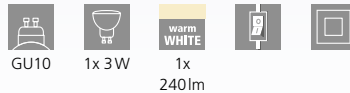

99036 PALBIETA

floor light; steel, black / plastic, clear, satiné
Stehleuchte; Stahl, schwarz / Kunststoff, klar, satiniert
lampadaire; acier, noir / plastique, clair, satiné

L 350, B 250, H 1530, Base: Ø 250

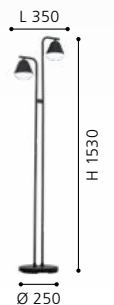
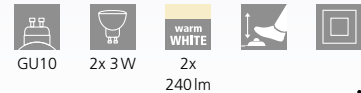



99378

This floor luminaire has additional lighting on the backside.

Die Stehleuchte hat zusätzlich an der Rückseite eine Beleuchtung.

Ce lampadaire dispose d'un éclairage supplémentaire à l'arrière.



99376

LED

99378

LED

99376 PHIANEROS

pendant light; steel, black / plastic, black, white
Hängeleuchte; Stahl, schwarz / Kunststoff, schwarz, weiss
luminaire en suspension; acier, noir / plastique, noir, blanc

L 1000, H 1200



22W 2700lm



9 002759 993764

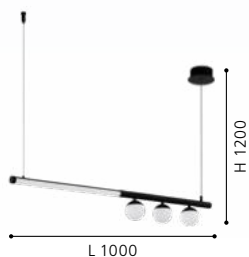

99378 PHIANEROS

floor light; steel, black / plastic, black, white
Stehleuchte; Stahl, schwarz / Kunststoff, schwarz, weiss
lampadaire; acier, noir / plastique, noir, blanc

H 1400, Ø 200



12W 1390lm 4W 389lm



9 002759 993788



99375 PHIANEROS

ceiling light; steel, black / plastic, black, white
Deckenleuchte; Stahl, schwarz / Kunststoff, schwarz, weiss
plafonnier; acier, noir / plastique, noir, blanc

H 120, Ø 400



22W 2800lm



9 002759 993757



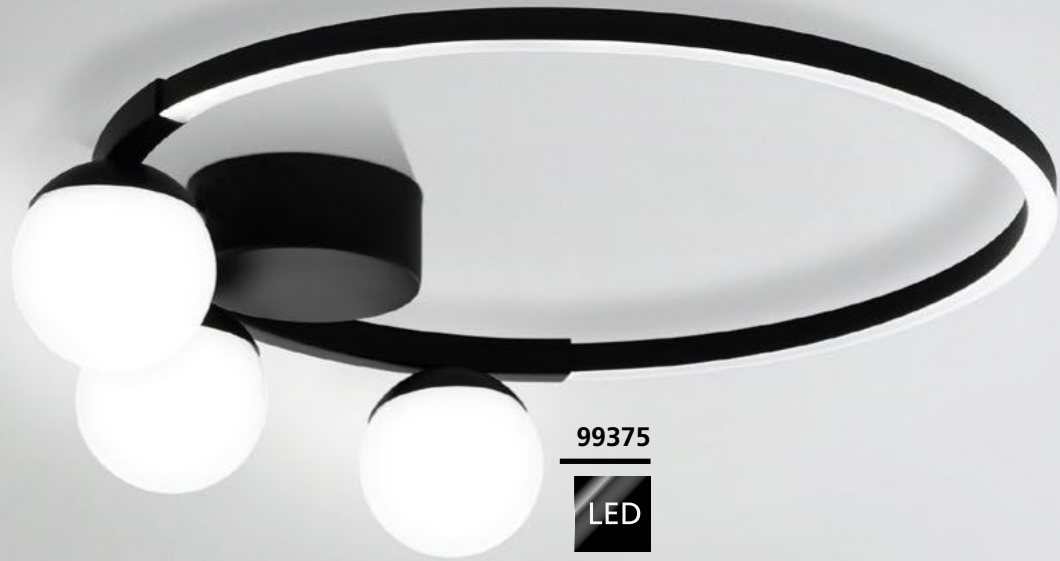

99375

LED

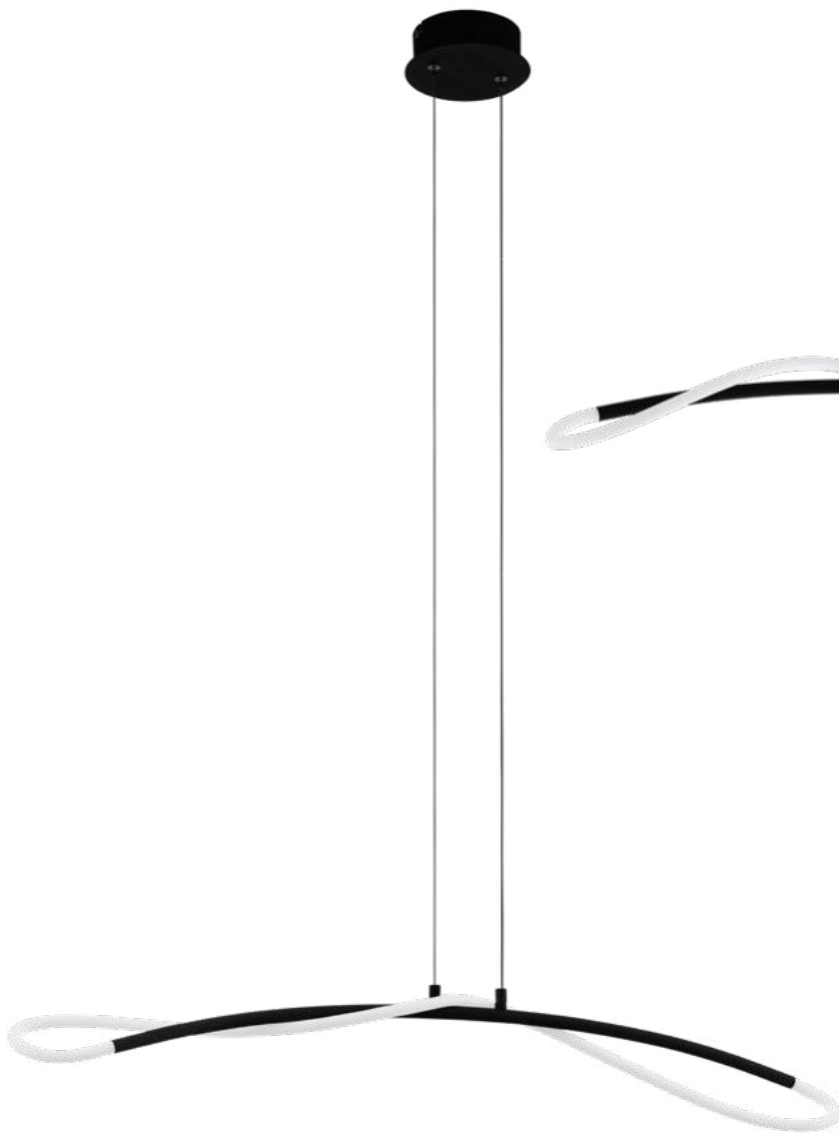

99381

LED

99382

LED

99382 EGIDONELLA

pendant light; steel, black / plastic, white
 Hängeleuchte; Stahl, schwarz / Kunststoff, weiss
 luminaire en suspension; acier, noir / plastique, blanc

L 900, B 140, H 1200



20W 3250lm



9 002759 993825



99381 EGIDONELLA

ceiling light; steel, black / plastic, white
 Deckenleuchte; Stahl, schwarz / Kunststoff, weiss
 plafonnier; acier, noir / plastique, blanc

L 900, B 140, H 210



20W 3250lm



9 002759 993818



99383 EGIDONELLA

table light; steel, black / plastic, white
 Tischleuchte; Stahl, schwarz / Kunststoff, weiss
 luminaire de table; acier, noir / plastique, blanc

L 355, B 150, H 380, Base: Ø 150



5,5W 700lm



9 002759 993832

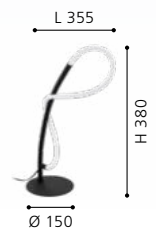



99383

LED

99384 EGIDONELLA

floor light; steel, black / plastic, white
 Stehleuchte; Stahl, schwarz / Kunststoff, weiss
 lampadaire; acier, noir / plastique, blanc

L 730, H 1600, Base: Ø 250

LED

20,5W

warm
 WHITE

2750lm



L 730

H 1600

Ø 250



9 002759 993849



99384

LED



99429

LED



39836

LED

39836 BANDERILLAS

ceiling light; steel, black / plastic, white, black
Deckenleuchte; Stahl, schwarz / Kunststoff, weiss, schwarz
plafonnier; acier, noir / plastique, blanc, noir

L 1160, B 170, H 200



2x 12W
2x
1950lm



9 002759 398361

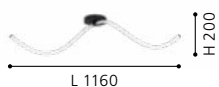

99429 ALAMEDILLA

pendant light; steel, black / plastic, white, black
Hängeleuchte; Stahl, schwarz / Kunststoff, weiss, schwarz
luminaire en suspension; acier, noir / plastique, blanc, noir

L 970, B 380, H 1200



27W
4200lm



9 002759 994297

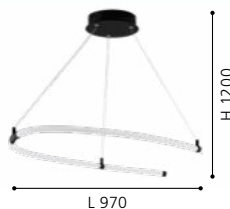

39838 BANDERILLAS

table light; plastic, black / plastic, white
Tischleuchte; Kunststoff, schwarz / Kunststoff, weiss
luminaire de table; plastique, noir / plastique, blanc

H 300, Ø 195



10W
1300lm



9 002759 398385

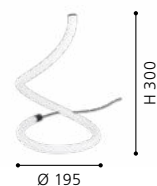



39838

LED



39839

LED

39839 BANDERILLAS

pendant light; steel, black / plastic, white, black
 Hängeleuchte; Stahl, schwarz / Kunststoff, weiss, schwarz
 luminaire en suspension; acier, noir / plastique, blanc, noir

H 1200, Ø 600

LED	warm WHITE	LED	warm WHITE	
22W	3500lm	14W	2300lm	



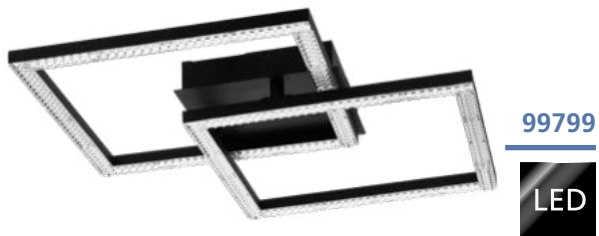

99799 LEJIAS

ceiling light; steel, black / plastic, transparent
Deckenleuchte; Stahl, schwarz / Kunststoff, transparent
plafonnier; acier, noir / plastique, transparent

L 450, B 450, H 75

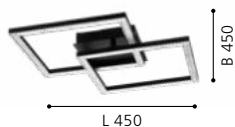

99801 LEJIAS

ceiling light; steel, black / plastic, transparent
Deckenleuchte; Stahl, schwarz / Kunststoff, transparent
plafonnier; acier, noir / plastique, transparent

L 780, B 80



99802 LEJIAS

pendant light; steel, black / plastic, transparent
Hängeleuchte; Stahl, schwarz / Kunststoff, transparent
luminaire en suspension; acier, noir / plastique, transparent

L 780, B 80, H 1100

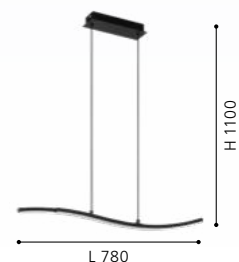

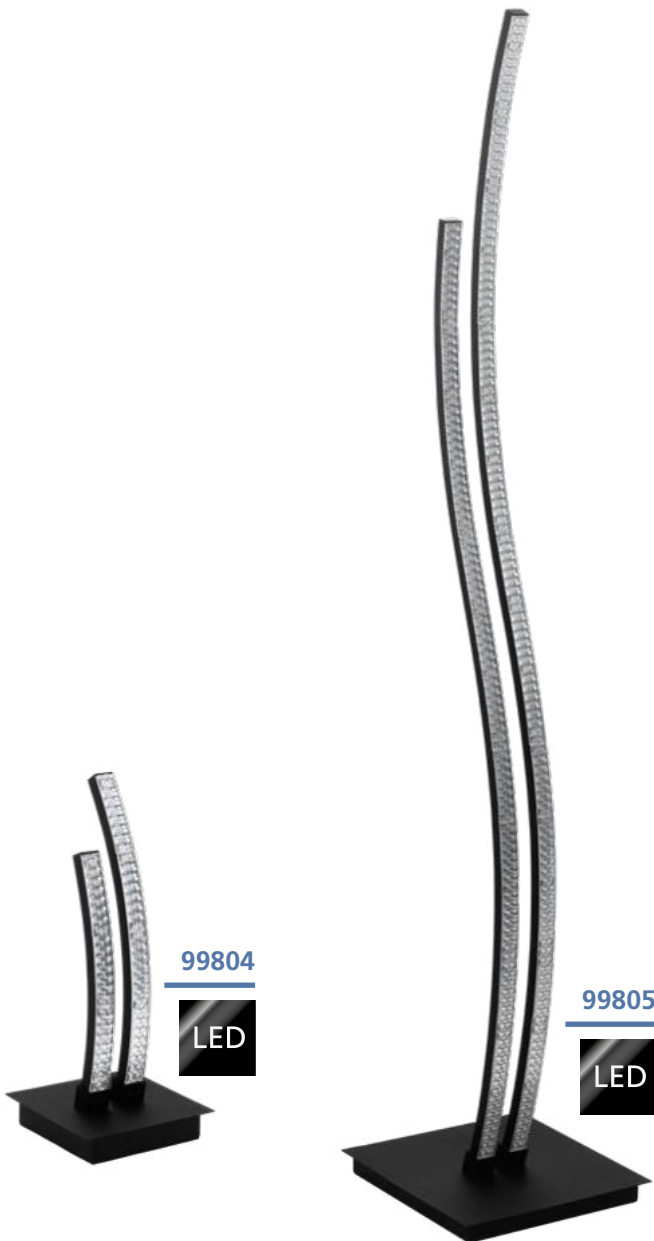

99804

LED

99805

LED



99803

LED

99804 LEJIAS

table light; steel, black / plastic, transparent
Tischleuchte; Stahl, schwarz / Kunststoff, transparent
luminaire de table; acier, noir / plastique, transparent

H 330, Base: B 140, T 140



8W 1050lm



9 002759 998042



99805 LEJIAS

floor light; steel, black / plastic, transparent
Stehleuchte; Stahl, schwarz / Kunststoff, transparent
lampadaire; acier, noir / plastique, transparent

H 1230, Base: B 230, T 230



16W 2050lm



9 002759 998059

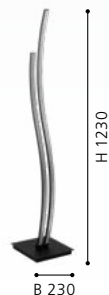

99803 LEJIAS

wall light; steel, black / plastic, transparent
Wandleuchte; Stahl, schwarz / Kunststoff, transparent
applique; acier, noir / plastique, transparent

L 90, H 285



8W 1050lm



9 002759 998035



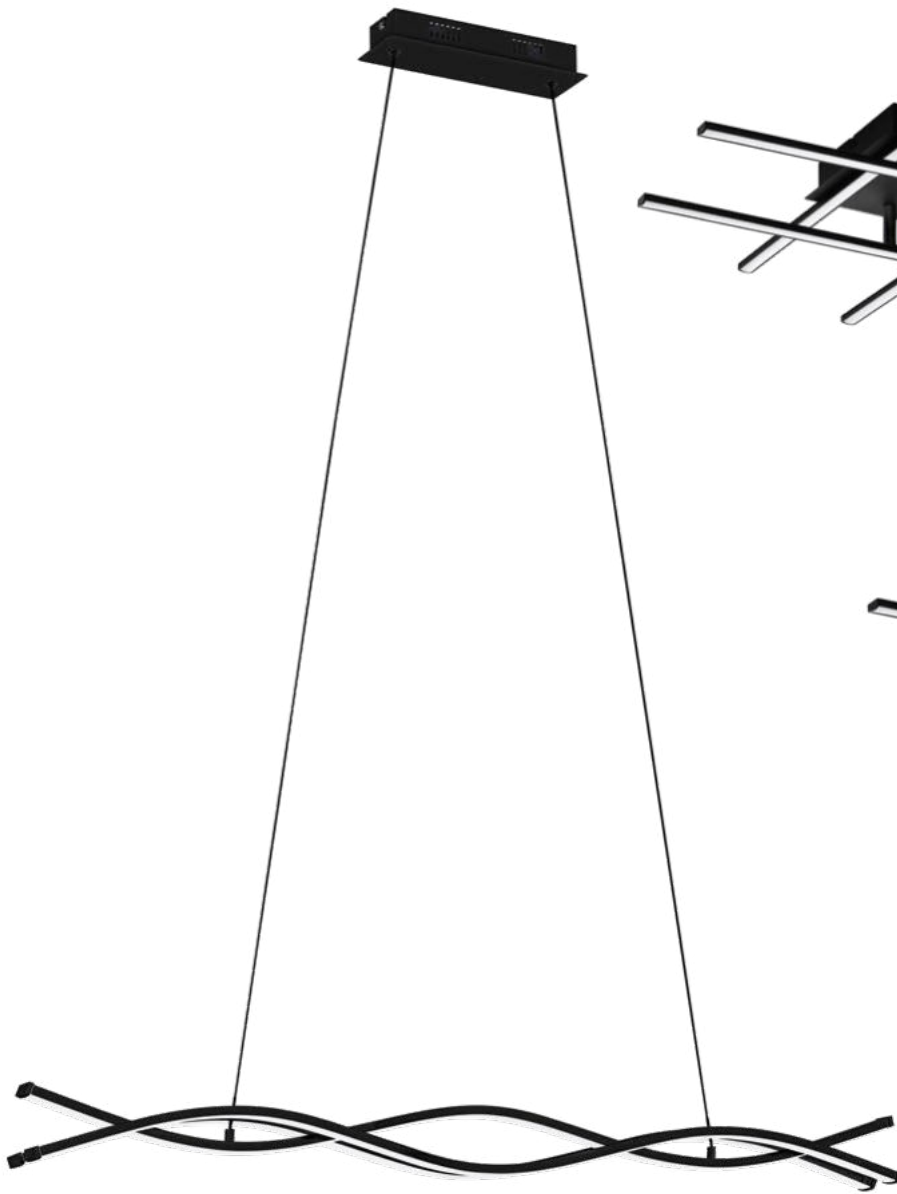

99317

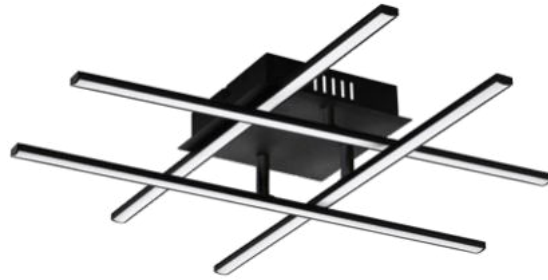

99316



99315



99317 LASANA 3

pendant light; steel, aluminium, black / plastic, white
Hängeleuchte; Stahl, Alu, schwarz / Kunststoff, weiss
luminaire en suspension; acier, aluminium, noir / plastique, blanc

L 985, B 80, H 1200



36W 5300lm

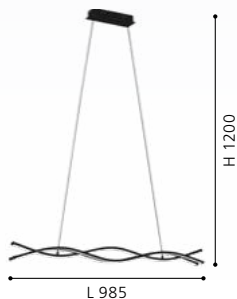

99316 LASANA 3

wall / ceiling light; steel, aluminium, black / plastic, white
Wand- / Deckenleuchte; Stahl, Alu, schwarz / Kunststoff, weiss
applique / plafonnier; acier, aluminium, noir / plastique, blanc

L 500, B 500, H 95



4x 5,2W 4x 740lm

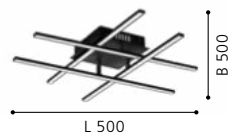

99315 LASANA 3

wall / ceiling light; steel, aluminium, black / plastic, white
Wand- / Deckenleuchte; Stahl, Alu, schwarz / Kunststoff, weiss
applique / plafonnier; acier, aluminium, noir / plastique, blanc

L 500, B 145, H 90



3x 3,5W 3x 500lm

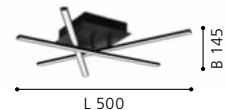



99319

LED



99318

LED

99319 LASANA 3

floor light; steel, aluminium, black / plastic, white
 Stehleuchte; Stahl, Alu, schwarz / Kunststoff, weiss
 lampadaire; acier, aluminium, noir / plastique, blanc

L 250, B 130, H 1420, Base: B 230, T 150



32W 3400lm



9 002759 993191



99318 LASANA 3

table light; steel, aluminium, black / plastic, white
 Tischleuchte; Stahl, Alu, schwarz / Kunststoff, weiss
 luminaire de table; acier, aluminium, noir / plastique, blanc

L 160, B 100, H 460, Base: B 180, T 100



10W 1100lm



9 002759 993184



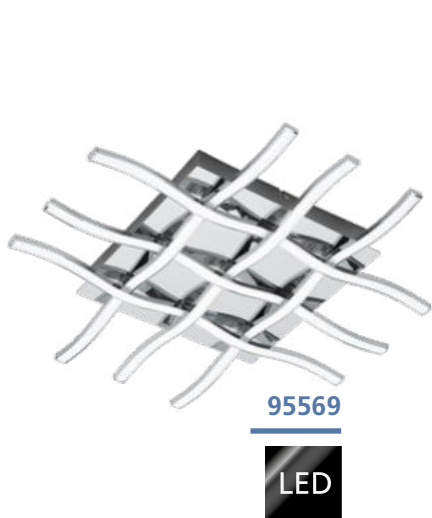

95569

LED

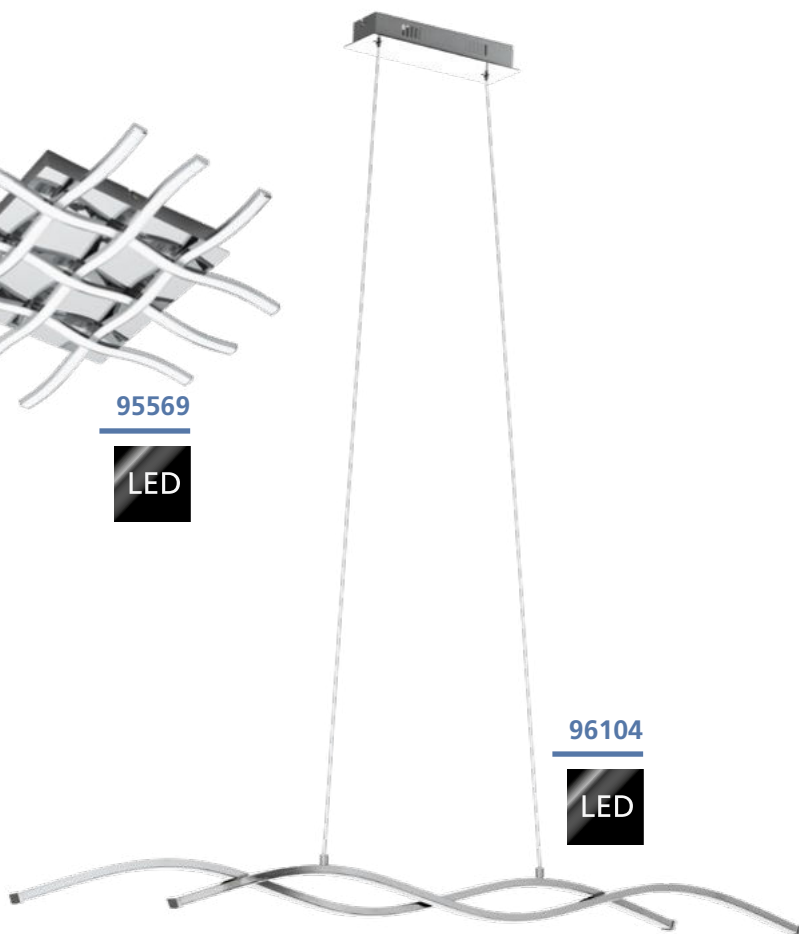

96104

LED

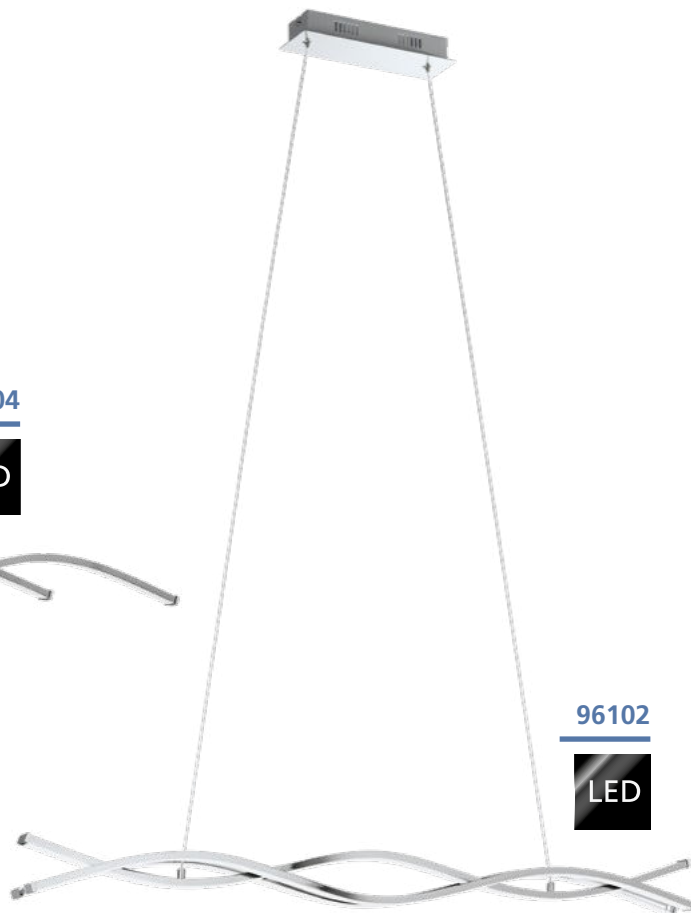

96102

LED

95569 LASANA 1

wall / ceiling light; steel, chrome / plastic, white
Wand- / Deckenleuchte; Stahl, chrom / Kunststoff, weiss
applique / plafonnier; acier, chrome / plastique, blanc

L 500, B 500, H 65

LED

warm
WHITE



36W

3780lm



9 002759 955694

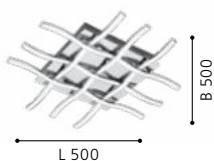

96104 LASANA 2

pendant light; steel, aluminium, chrome / plastic, white
Hängeleuchte; Stahl, Alu, chrom / Kunststoff, weiss
luminaire en suspension; acier, aluminium, chrome / plastique, blanc

L 1200, B 80, H 1200

LED

warm
WHITE



2x 12W

2600lm



9 002759 961046



96102 LASANA 2

pendant light; steel, aluminium, chrome / plastic, white
Hängeleuchte; Stahl, Alu, chrom / Kunststoff, weiss
luminaire en suspension; acier, aluminium, chrome / plastique, blanc

L 1000, B 80, H 1200

LED

warm
WHITE



3x 12W

3900lm



9 002759 961022



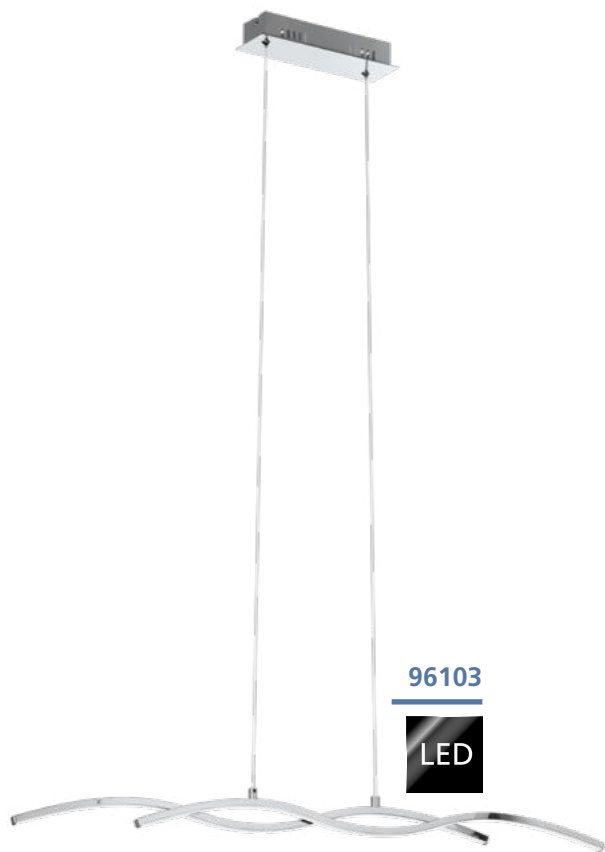

96103

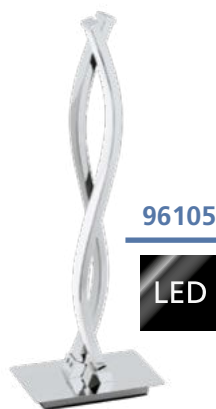

96105



96106



96103 LASANA 2

pendant light; steel, aluminium, chrome / plastic, white
 Hängeleuchte; Stahl, Alu, chrom / Kunststoff, weiss
 luminaire en suspension; acier, aluminium, chrome / plastique, blanc

L 870, B 80, H 1200



2x 9W
 2x
 1000lm



9 002759 961039



96105 LASANA 2

table light; steel, aluminium, chrome / plastic, white
 Tischleuchte; Stahl, Alu, chrom / Kunststoff, weiss
 luminaire de table; acier, aluminium, chrome / plastique, blanc

L 160, B 100, H 460



2x 5W
 2x
 500lm



9 002759 961053



96106 LASANA 2

floor light; steel, aluminium, chrome / plastic, white
 Stehleuchte; Stahl, Alu, chrom / Kunststoff, weiss
 lampadaire; acier, aluminium, chrome / plastique, blanc

L 250, B 130, H 1420



4x 9W
 4x
 1000lm



9 002759 961060





95147

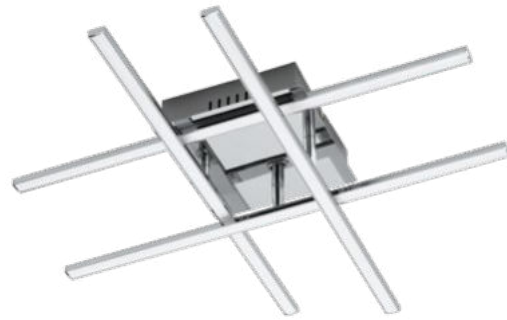

95568



32048



95147 LASANA

pendant light; aluminium, steel, chrome / plastic, white
 Hängeleuchte; Alu, Stahl, chrom / Kunststoff, weiss
 luminaire en suspension; aluminium, acier, chrome / plastique, blanc

L 900, H 1100



30W 2500lm



9 002759 951474

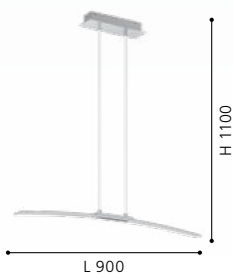

32048 LASANA

pendant light; aluminium, steel, chrome / plastic, white
 Hängeleuchte; Alu, Stahl, chrom / Kunststoff, weiss
 luminaire en suspension; aluminium, acier, chrome / plastique, blanc

L 900, H 1000



14W 1400lm



9 002759 320485



95568 LASANA 1

wall / ceiling light; steel, chrome / plastic, white
 Wand- / Deckenleuchte; Stahl, chrom / Kunststoff, weiss
 applique / plafonnier; acier, chrome / plastique, blanc

L 500, B 500, H 95



24W 2520lm



9 002759 955687

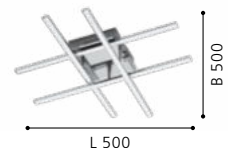



96107



96108



95567



LASANA 2

The arms of these luminaires are movable.

Die Leuchtenarme sind beweglich.

Les bras de ces luminaires sont mobiles.

96107 LASANA 2

ceiling light; steel, aluminium, chrome / plastic, white
Deckenleuchte; Stahl, Alu, chrom / Kunststoff, weiss
plafonnier; acier, aluminium, chrome / plastique, blanc

L 1000, B 80, H 60



2x 9W
2x
1100lm

96108 LASANA 2

ceiling light; steel, aluminium, chrome / plastic, white
Deckenleuchte; Stahl, Alu, chrom / Kunststoff, weiss
plafonnier; acier, aluminium, chrome / plastique, blanc

L 1410, B 80, H 85



3x 7,8W
3x
1000lm

95567 LASANA 1

wall / ceiling light; steel, chrome / plastic, white
Wand- / Deckenleuchte; Stahl, chrom / Kunststoff, weiss
applique / plafonnier; acier, chrome / plastique, blanc

L 500, B 160, H 95

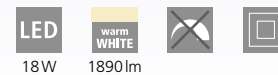

18W
1890lm



9 002759 961077

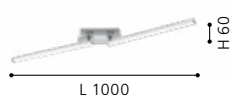

9 002759 961084



9 002759 955670

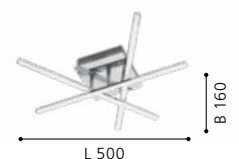



99322

LED



99321

LED



99323

LED

99322 RONCADE 1

wall / ceiling light; steel, aluminium, black / plastic, white
Wand- / Deckenleuchte; Stahl, Alu, schwarz / Kunststoff, weiss
applique / plafonnier; acier, aluminium, noir / plastique, blanc

L 1160, B 180, H 115



36W 4600lm



9 002759 993221

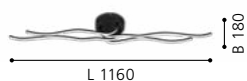

99321 RONCADE 1

wall / ceiling light; steel, aluminium, black / plastic, white
Wand- / Deckenleuchte; Stahl, Alu, schwarz / Kunststoff, weiss
applique / plafonnier; acier, aluminium, noir / plastique, blanc

L 650, B 130, H 45



21W 2800lm



9 002759 993214

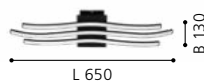

99323 SELVINA 1

ceiling light; steel, aluminium, black / plastic, white
Deckenleuchte; Stahl, Alu, schwarz / Kunststoff, weiss
plafonnier; acier, aluminium, noir / plastique, blanc

L 690, B 280, H 150



21W 3150lm



9 002759 993238





31996



31995



31996 RONCADE

wall / ceiling light; aluminium, steel, chrome / plastic, white
 Wand- / Deckenleuchte; Alu, Stahl, chrom / Kunststoff, weiss
 applique / plafonnier; aluminium, acier, chrome / plastique, blanc

L 1085, B 160, H 125



32W 4500lm

31995 RONCADE

wall / ceiling light; aluminium, steel, chrome / plastic, white
 Wand- / Deckenleuchte; Alu, Stahl, chrom / Kunststoff, weiss
 applique / plafonnier; aluminium, acier, chrome / plastique, blanc

L 650, B 130, H 45



26W 2400lm



9 002759 319960



9 002759 319953



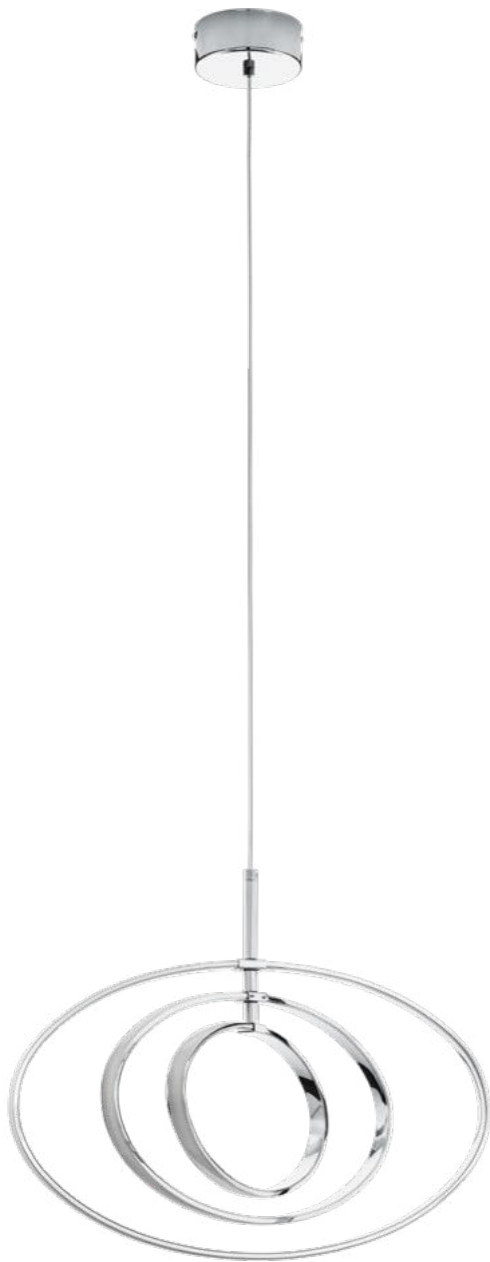

97435



96306



96308



97435 PAUSIA

pendant light; steel, aluminium, chrome / plastic, white
 Hängeleuchte; Stahl, Alu, chrom / Kunststoff, weiss
 luminaire en suspension; acier, aluminium, chrome / plastique, blanc

L 540, B 470, H 1500

- LED 1x 7W
- warm WHITE 1x 1000lm
- LED 1x 6W
- warm WHITE 1x 900lm
- LED 1x 5W
- warm WHITE 1x 800lm



9 002759 974350



96306 SELVINA

ceiling light; aluminium, chrome / plastic, white
 Deckenleuchte; Alu, chrom / Kunststoff, weiss
 plafonnier; aluminium, chrome / plastique, blanc

L 460, B 390, H 380

- LED 1x 12W
- warm WHITE 1x 1300lm
- LED 1x 14W
- warm WHITE 1x 1600lm
- LED 1x 9W
- warm WHITE 1x 1000lm



9 002759 963064

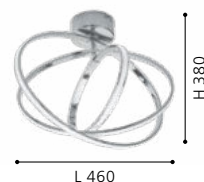

96308 SELVINA

ceiling light; aluminium, chrome / plastic, white
 Deckenleuchte; Alu, chrom / Kunststoff, weiss
 plafonnier; aluminium, chrome / plastique, blanc

L 745, B 175, H 85

- LED 1x 6W
- warm WHITE 1x 650lm
- LED 1x 7W
- warm WHITE 1x 750lm
- LED 1x 9W
- warm WHITE 1x 1000lm



9 002759 963088





96329



96307



96329 SELVINA

ceiling light; aluminium, chrome / plastic, white
 Deckenleuchte; Alu, chrom / Kunststoff, weiss
 plafonnier; aluminium, chrome / plastique, blanc

L 700, B 420, H 150



2x 10W

2x
900lm

96307 SELVINA

ceiling light; aluminium, chrome / plastic, white
 Deckenleuchte; Alu, chrom / Kunststoff, weiss
 plafonnier; aluminium, chrome / plastique, blanc

H 185, Ø 520



3x 8W

3x
900lm



9 002759 963293



9 002759 963071

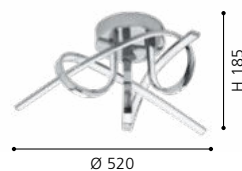



96325

LED



96326

LED

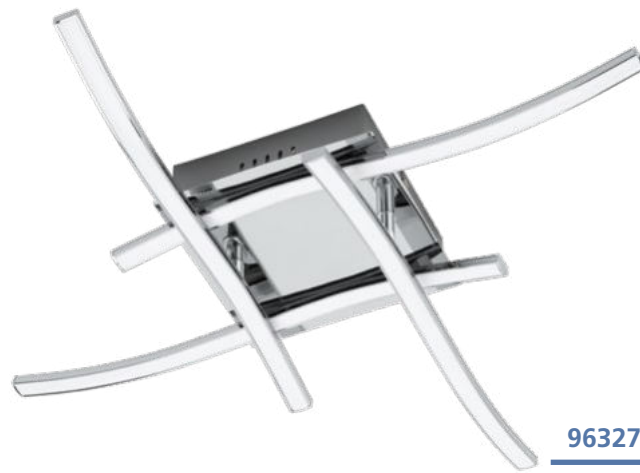

96327

LED

96325 VALMORA

ceiling light; aluminium, chrome / plastic, white
Deckenleuchte; Alu, chrom / Kunststoff, weiss
plafonnier; aluminium, chrome / plastique, blanc

L 630, B 90, H 85

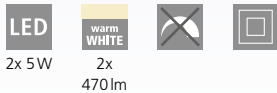

2x 5W
2x
470lm



9 002759 963255



L 630

B 90

96327 VALMORA

ceiling light; aluminium, chrome / plastic, white
Deckenleuchte; Alu, chrom / Kunststoff, weiss
plafonnier; aluminium, chrome / plastique, blanc

L 560, B 560, H 105

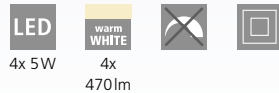

4x 5W
4x
470lm



9 002759 963279

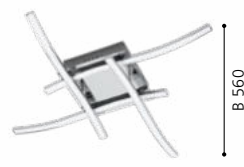

L 560

B 560

96326 VALMORA

ceiling light; aluminium, chrome / plastic, white
Deckenleuchte; Alu, chrom / Kunststoff, weiss
plafonnier; aluminium, chrome / plastique, blanc

L 590, B 125, H 90



3x 5W
3x
470lm



9 002759 963262



L 590

B 125



96332



96305



96331



96332 VALMORA

wall light; aluminium, chrome / plastic, white
Wandleuchte; Alu, chrom / Kunststoff, weiss
applique; aluminium, chrome / plastique, blanc

L 115, H 450, A 90



2x 5W
2x
470lm



9 002759 963323



L 115

96331 NEVADO

pendant light; aluminium, chrome / plastic, white
Hängeleuchte; Alu, chrom / Kunststoff, weiss
luminaire en suspension; aluminium, chrome / plastique, blanc

L 900, B 80, H 1100



3x 9W
3x
1000lm



9 002759 963316

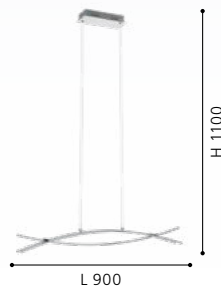

L 900

96305 NEVADO

ceiling light; aluminium, chrome / plastic, white
Deckenleuchte; Alu, chrom / Kunststoff, weiss
plafonnier; aluminium, chrome / plastique, blanc

L 500, B 500, H 115



4x 5W
4x
470lm



9 002759 963057

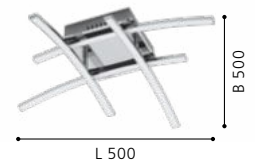

L 500



DESIGN
HIGHLIGHT
DETAIL

96096 PERTINI

pendant light; steel, aluminium, chrome / plastic, transparent
Hängeleuchte; Stahl, Alu, chrom / Kunststoff, transparent
luminaire en suspension; acier, aluminium, chrome / plastique, transparent

L 960, B 80, H 1100

LED warm WHITE 2x 10,8W 2x 1300lm

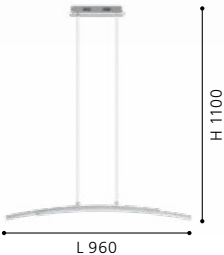

96093 PERTINI

ceiling light; steel, aluminium, chrome / plastic, transparent
Deckenleuchte; Stahl, Alu, chrom / Kunststoff, transparent
plafonnier; acier, aluminium, chrome / plastique, transparent

L 450, B 450, H 125

LED warm WHITE 4x 5W 4x 580lm

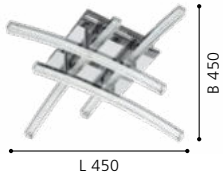

96097 PERTINI

wall light; steel, aluminium, chrome / plastic, transparent
Wandleuchte; Stahl, Alu, chrom / Kunststoff, transparent
applique; acier, aluminium, chrome / plastique, transparent

L 60, H 330, A 75

LED warm WHITE 2x 3W 2x 380lm





96409

LED



96866

LED

96409 LAPELA

wall / ceiling light; aluminium, steel, chrome / plastic, satined
Wand- / Deckenleuchte; Alu, Stahl, chrom / Kunststoff, satiniert
applique / plafonnier; aluminium, acier, chrome / plastique, satiné

L 858, B 80, H 90



2x 10W

2x
1300lm



9 002759 964092



96866 TARANDELL

pendant light; aluminium, steel, chrome / plastic, satined
Hängeleuchte; Alu, Stahl, chrom / Kunststoff, satiniert
luminaire en suspension; aluminium, acier, chrome / plastique, satiné

L 1180, B 60, H 930 - 1620

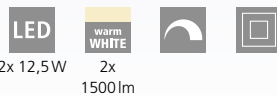

2x 12,5W

2x
1500lm



9 002759 968663





98889



99559



98889 PALOZZA 1

wall light; aluminium, satin nickel / plastic, white
Wandleuchte; Alu, nickel-matt / Kunststoff, weiss
applique; aluminium, nickel mat / plastique, blanc

L 170, H 425, A 60



12W



1200lm



9 002759 988890



99559 PALOZZA 1

table light; aluminium, satin nickel / plastic, white
Tischleuchte; Alu, nickel-matt / Kunststoff, weiss
luminaire de table; aluminium, nickel mat / plastique, blanc

L 140, B 110, H 410



9,8W



1000lm



9 002759 995591



31997 RONCADE

table light; aluminium, steel, chrome / plastic, white
Tischleuchte; Alu, Stahl, chrom / Kunststoff, weiss
luminaire de table; aluminium, acier, chrome / plastique, blanc

L 195, B 150, H 335



14W



1200lm



9 002759 319977





31997

LED



97362

LED



97361

LED



97363

LED

97362 PALOZZA

pendant light; aluminium, rose gold / plastic, white
 Hängeleuchte; Alu, roségold / Kunststoff, weiss
 luminaire en suspension; aluminium, or rose / plastique, blanc

L 705, B 315, H 1100



2x 11 W
 2x
 1500lm



9 002759 973629

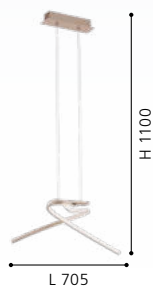

97361 PALOZZA

ceiling light; aluminium, rose gold / plastic, white
 Deckenleuchte; Alu, roségold / Kunststoff, weiss
 plafonnier; aluminium, or rose / plastique, blanc

L 705, B 315, H 125



2x 11 W
 2x
 1500lm



9 002759 973612

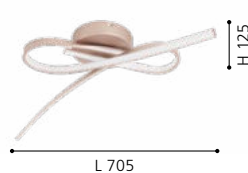

97363 PALOZZA

wall light; aluminium, rose gold / plastic, white
 Wandleuchte; Alu, roségold / Kunststoff, weiss
 applique; aluminium, or rose / plastique, blanc

L 170, H 425, A 60



1x 11 W
 1x
 1500lm



9 002759 973636





97365

LED



97364

LED

97365 PALOZZA

floor light; aluminium, rose gold / plastic, white
 Stehleuchte; Alu, roségold / Kunststoff, weiss
 lampadaire; aluminium, or rose / plastique, blanc

H 1175, Ø 220, Base: Ø 220



97364 PALOZZA

table light; aluminium, rose gold / plastic, white
 Tischleuchte; Alu, roségold / Kunststoff, weiss
 luminaire de table; aluminium, or rose / plastique, blanc

H 380, Ø 185, Base: Ø 150

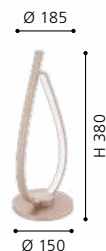



97937

LED

97938

LED

97938 NOVA FELTRIA

pendant light; steel, aluminium, satin nickel / plastic, white
 Hängeleuchte; Stahl, Alu, nickel-matt / Kunststoff, weiss
 luminaire en suspension; acier, aluminium, nickel mat / plastique, blanc

L 900, B 200, H 1500

LED

warm
WHITE
1600lm



16W

1600lm



9 002759 979386



L 900

H 1500

97937 NOVA FELTRIA

ceiling light; steel, aluminium, satin nickel / plastic, white
 Deckenleuchte; Stahl, Alu, nickel-matt / Kunststoff, weiss
 plafonnier; acier, aluminium, nickel mat / plastique, blanc

L 700, B 160, H 160

LED

warm
WHITE
1300lm



13W

1300lm



9 002759 979379



L 700

H 160

97941 NOVA FELTRIA

table light; steel, aluminium, satin nickel / plastic, white
 Tischleuchte; Stahl, Alu, nickel-matt / Kunststoff, weiss
 luminaire de table; acier, aluminium, nickel mat / plastique, blanc

L 160, B 160, H 410, Base: Ø 130

LED

warm
WHITE
1000lm



10W

1000lm



9 002759 979416

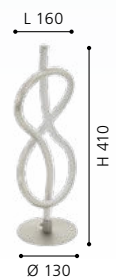

Ø 130

H 410



97941



97939 NOVAFELTRIA

wall light; steel, aluminium, satin nickel / plastic, white
Wandleuchte; Stahl, Alu, nickel-matt / Kunststoff, weiss
applique; acier, aluminium, nickel mat / plastique, blanc

L 160, H 400, A 160



10W



1000lm



9 002759 979393

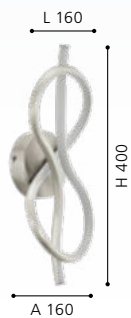

97939



LIGHTING FAMILIES

GLASS CHANDELIERS

GLASLUSTER

LUSTRES EN VERRE

SPARKLING -

Extravagant lighting – our glass chandeliers will give you light in a new diversity while ensuring an extraordinary ambience. Our chandeliers are true jewels on your ceiling and spread their elegance in your entire living area.

FUNKELN -

Beleuchtung der Extravaganz – Mit unseren Glaslustern erleben Sie Licht in neuer Vielfalt und sorgen für ein außergewöhnliches Ambiente. Unsere Kronleuchter werden zum wahren Schmuckstück und bringen Eleganz in all Ihre Wohnbereiche.



DU SCINTILLEMENT -

Un éclairage riche en extravagance – Avec nos lustres en verre, vous faites l'expérience de la lumière dans une nouvelle multiplicité et vous assurez une ambiance extraordinaire. Nos plafonniers lustres en deviennent de vrais bijoux et prêtent de l'élégance à tous vos espaces d'habitat.



OVERVIEW

LIGHTING FAMILIES / GLASS CHANDELIERS



BASILANO 1
p. 306



BASILANO 1
p. 306



BASILANO 1
p. 306



BASILANO 1
p. 307



BASILANO
p. 308



BASILANO
p. 308



BASILANO
p. 309



BASILANO
p. 309



CARPENTO
p. 310



CARPENTO
p. 310



CARPENTO
p. 310





39103



39101

39103 BASILANO 1

pendant light; steel, chrome / glass, clear
 Hängeleuchte; Stahl, chrom / Glas, klar
 luminaire en suspension; acier, chrome / verre, clair

H 1500, Ø 1000



E14 18x40W



9 002759 391034

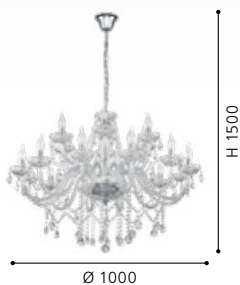

Ø 1000

H 1500

39101 BASILANO 1

pendant light; steel, chrome / glass, clear
 Hängeleuchte; Stahl, chrom / Glas, klar
 luminaire en suspension; acier, chrome / verre, clair

H 1300, Ø 820

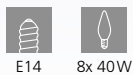

E14 8x40W



9 002759 391010



Ø 820

H 1300

39099 BASILANO 1

pendant light; steel, chrome / glass, clear
 Hängeleuchte; Stahl, chrom / Glas, klar
 luminaire en suspension; acier, chrome / verre, clair

H 1300, Ø 720

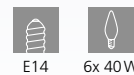

E14 6x40W



9 002759 390990



Ø 720

H 1300



39099



39102

39102 BASILANO 1

pendant light; steel, chrome / glass, clear

Hängeleuchte; Stahl, chrom / Glas, klar

luminaire en suspension; acier, chrome / verre, clair

H 1500, Ø 1000



E14



12x 40W



9 002759 391027



H 1500

Ø 1000



39095



39092

39095 BASILANO

pendant light; steel, chrome / glass, cognac
 Hängeleuchte; Stahl, chrom / Glas, cognac
 luminaire en suspension; acier, chrome / verre, cognac

H 1500, Ø 1000



Ø 1000

39092 BASILANO

pendant light; steel, chrome / glass, cognac
 Hängeleuchte; Stahl, chrom / Glas, cognac
 luminaire en suspension; acier, chrome / verre, cognac

H 1300, Ø 720



Ø 720



39093



39094

39093 BASILANO

pendant light; steel, chrome / glass, cognac
 Hängeleuchte; Stahl, chrom / Glas, cognac
 luminaire en suspension; acier, chrome / verre, cognac

H 1300, Ø 820



9 002759 390938



39094 BASILANO

pendant light; steel, chrome / glass, cognac
 Hängeleuchte; Stahl, chrom / Glas, cognac
 luminaire en suspension; acier, chrome / verre, cognac

H 1500, Ø 1000



9 002759 390945





39113



39112

39113 CARPENTO

pendant light; steel, chrome / glass, white
 Hängeleuchte; Stahl, chrom / Glas, weiss
 luminaire en suspension; acier, chrome / verre, blanc

H 1200, Ø 590



E14 5x 40W



9 002759 391133



Ø 590

H 1200

39112 CARPENTO

pendant light; steel, chrome / glass, white
 Hängeleuchte; Stahl, chrom / Glas, weiss
 luminaire en suspension; acier, chrome / verre, blanc

H 1200, Ø 540



E14 3x 40W



9 002759 391126



Ø 540

H 1200

39114 CARPENTO

pendant light; steel, chrome / glass, white
 Hängeleuchte; Stahl, chrom / Glas, weiss
 luminaire en suspension; acier, chrome / verre, blanc

H 1300, Ø 700



E14 8x 40W



9 002759 391140



Ø 700

H 1300



39114



HANGING & PENDANT LUMINAIRES

HÄNGE- & PENDELLEUCHTEN
LUMINAIRES SUSPENSIONS

SUSPENDED LIGHTING -

Our wide variety of suspended and pendant luminaires contain classical as well as extravagant designs and supply any furnishing style. Set beautiful accents with your favourites and give your home a special atmosphere.

BELEUCHTUNG ZUM ABHÄNGEN -

Unser breitgefächertes Hänge- und Pendelleuchten-Sortiment beinhaltet sowohl klassische als auch extravagante Designs und bedient jeden Einrichtungsstil. Setzen Sie mit Ihren Favoriten schöne Akzente und verleihen Sie Ihrem Zuhause eine besondere Atmosphäre.

















































ÉCLAIRAGES SUSPENDUS -

Notre large gamme d'éclairages suspendus et pendulaires comprend aussi bien des designs classiques qu'extravagants et est adaptée à tout style d'ameublement. Mettez avec vos favoris de beaux accents et donnez une atmosphère particulière à votre intérieur.

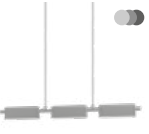

OVERVIEW

HANGING & PENDANT LUMINAIRES

 OILLELLA p. 316-317	 LEBALIO p. 318	 ALOBRASE p. 319-321	 CADAQUES p. 322	 CADAQUES 1 p. 322	 TORRONTES p. 322	 TINDARI p. 323	 ARISCANI p. 324-325
 MURMILLO p. 326	 FARSALA p. 327	 SELVINO p. 328-329	 ZABALEA p. 330	 ALBARACCIN p. 330-331	 LAGUNITAS p. 332	 CERASELLA p. 333	 ROCAMAR p. 334, 336
 ROCAMAR 1 p. 335-336	 CORETTO p. 335	 LONCINO 1 p. 337	 ALEANDRO 1 p. 338	 ROMAGNESE p. 338	 BOLSANO p. 338-339	 CARDITO 1 p. 340	 FEDRA 2 p. 341
 DIAMOND p. 341	 VARRAZO p. 341	 LUBERIO p. 342	 MONTEFIO 1 p. 342-343	 MIOGLIA 1 p. 344	 CONESSA p. 344-345	 ENALURI p. 346	 CARTAMA p. 347
 MONTEFINO p. 348	 CORTENOVA p. 350-351	 POZUETA p. 353	 BOCADELLA p. 354	 MEZZANA p. 354	 GRADOLI p. 356	 GRADOLI 1 p. 357	 MANIZALES p. 357
 MONTEBALDO p. 358	 BITACHITO p. 358	 LOBATIA p. 359	 GATUELA 1 p. 360	 GATUELA p. 360-361	 ROVIRA p. 361	 CAMARGO p. 362	 PERPIGO p. 363
 AMONTILLADO p. 364	 CAMBULOS p. 364	 SPADAFORA p. 364	 ERMUA p. 365	 CORREDERA p. 366	 BOGOTENILLO p. 366	 CODRIALES p. 367	 SALITRE p. 367

 This product is available in different colors and shapes./ Dieser Artikel ist in unterschiedlichen Farben und Formen verfügbar.
Cet article est disponible en différentes couleurs et formes.

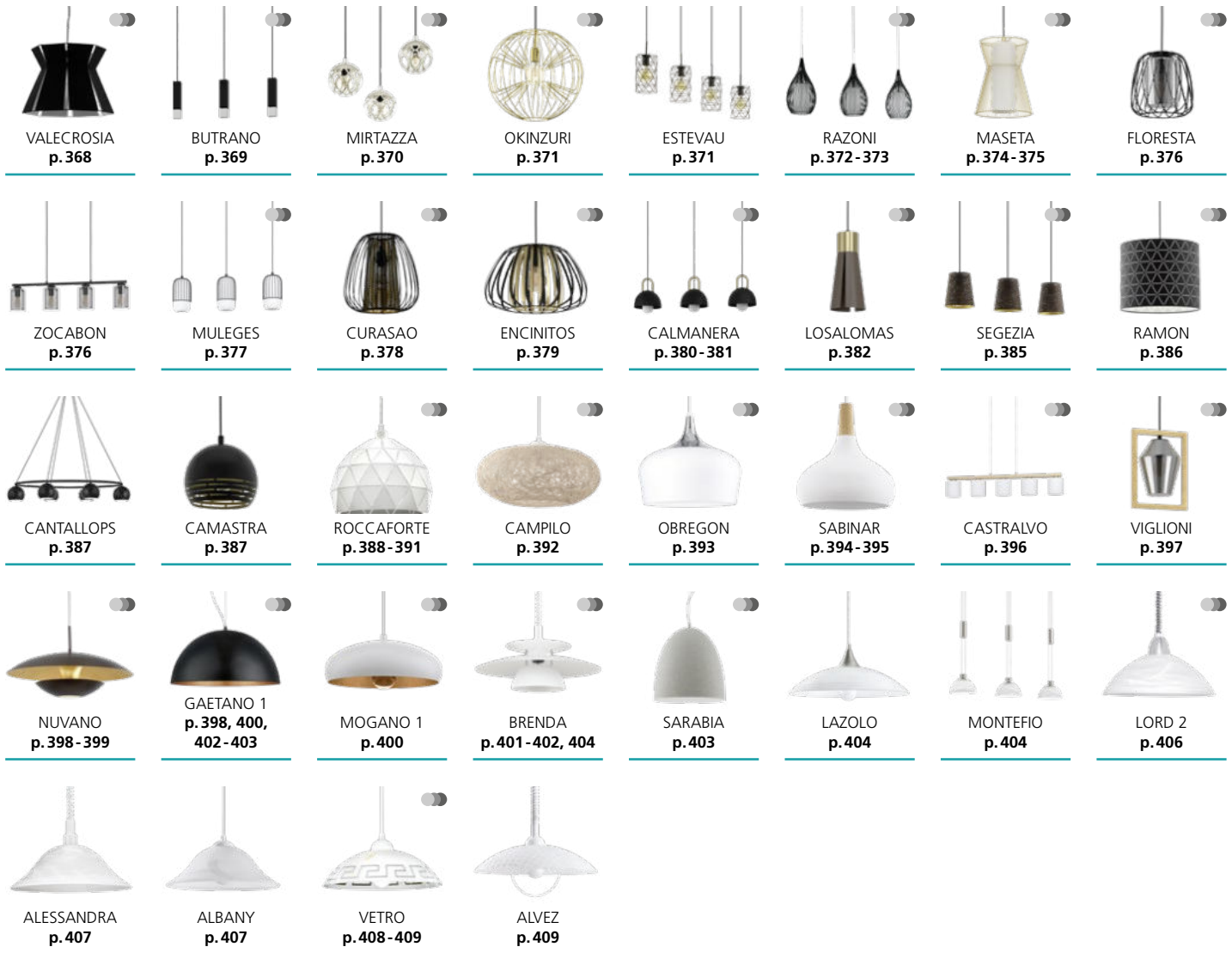



99614 OIELLA

pendant light; steel, black, brass / glass vaporized, black-brown-transparent

Hängeleuchte; Stahl, schwarz, messing / Glas bedampft, schwarz-braun-transparent

luminaire en suspension; acier, noir, laiton / verre vaporisé, noir-marron-transparent

H 1100, Ø 190



E27

1x 40W



9 002759 996147



99615 OIELLA

pendant light; steel, black, brass / glass vaporized, black-brown-transparent

Hängeleuchte; Stahl, schwarz, messing / Glas bedampft, schwarz-braun-transparent

luminaire en suspension; acier, noir, laiton / verre vaporisé, noir-marron-transparent

L 950, B 190, H 1100



E27

3x 40W



9 002759 996154



99616 OIELLA

pendant light; steel, black, brass / glass vaporized, black-grey-transparent

Hängeleuchte; Stahl, schwarz, messing / Glas bedampft, schwarz-grau-transparent

luminaire en suspension; acier, noir, laiton / verre vaporisé, noir-gris-transparent

H 1100, Ø 190



E27

1x 40W



9 002759 996161

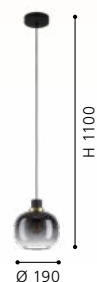



99617



99617 OILELLA

pendant light; steel, black, brass / glass vaporized,
black-grey-transparent

Hängeleuchte; Stahl, schwarz, messing / Glas bedampft,
schwarz-grau-transparent

luminaire en suspension; acier, noir, laiton / verre vaporisé,
noir-gris-transparent

L 950, B 190, H 1100



E27



3x 40W

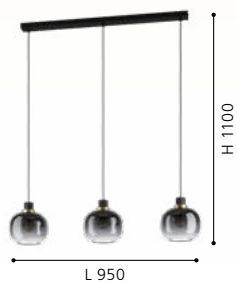

DESIGN
HIGHLIGHT
DETAIL



99313



99314



EGLO
RECOMMENDS
11491

99313 | 99314

99313 LEBALIO

pendant light; steel, bronzed / glass vaporized, black-transparent
Hängeleuchte; Stahl, brüniert / Glas bedampft, schwarz-transparent
luminaire en suspension; acier, bruni / verre vaporisé, noir transparent

H 1100, Ø 195



E27 1x 40W



9 002759 993139



Ø 195

99314 LEBALIO

pendant light; steel, bronzed / glass vaporized, black-transparent
Hängeleuchte; Stahl, brüniert / Glas bedampft, schwarz-transparent
luminaire en suspension; acier, bruni / verre vaporisé, noir transparent

L 1125, B 195, H 1100



E27 3x 40W



9 002759 993146

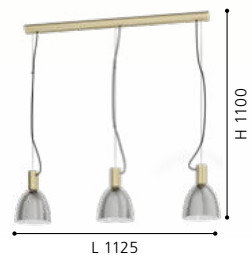

L 1125



98647 | 98648 | 98649

98647 ALOBRASE

pendant light; steel, brushed brass / glass vaporized, amber
 Hängeleuchte; Stahl, messing-gebürstet / Glas bedampft, amber
 luminaire en suspension; acier, laiton brossé / verre vaporisé, ambre

H 1100, Ø 300



9 002759 986476



98648 ALOBRASE

pendant light; steel, brushed brass / glass vaporized, amber
 Hängeleuchte; Stahl, messing-gebürstet / Glas bedampft, amber
 luminaire en suspension; acier, laiton brossé / verre vaporisé, ambre

H 1100, Ø 200



9 002759 986483

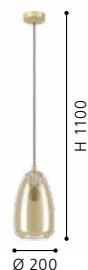

98649 ALOBRASE

pendant light; steel, brushed brass / glass vaporized, amber
 Hängeleuchte; Stahl, messing-gebürstet / Glas bedampft, amber
 luminaire en suspension; acier, laiton brossé / verre vaporisé, ambre

L 1080, B 150, H 1100



9 002759 986490

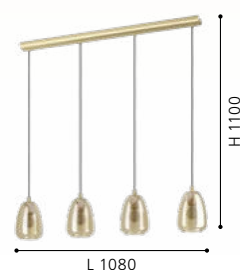



98614



98616



98614 | 98615 | 98616 |
98617

98614 ALOBRASE

pendant light; steel, chrome / glass vaporized, black-transparent
Hängeleuchte; Stahl, chrom / Glas bedampft, schwarz-transparent
luminaire en suspension; acier, chrome / verre vaporisé, noir transparent

H 1100, Ø 300

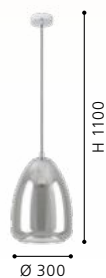

98616 ALOBRASE

pendant light; steel, chrome / glass vaporized, black-transparent
Hängeleuchte; Stahl, chrom / Glas bedampft, schwarz-transparent
luminaire en suspension; acier, chrome / verre vaporisé, noir transparent

L 1080, B 150, H 1100

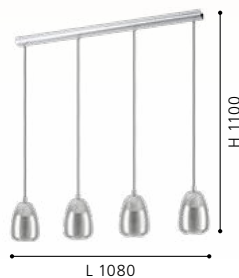

98615 ALOBRASE

pendant light; steel, chrome / glass vaporized, black-transparent
Hängeleuchte; Stahl, chrom / Glas bedampft, schwarz-transparent
luminaire en suspension; acier, chrome / verre vaporisé, noir transparent

H 1100, Ø 200





98615



98617

98617 ALOBRASE

pendant light; steel, chrome / glass vaporized, black-transparent
Hängeleuchte; Stahl, chrom / Glas bedampft, schwarz-transparent
luminaire en suspension; acier, chrome / verre vaporisé, noir transparent

H 1500, Ø 540



E27



5x 40W



9 002759 986179





98582 | 98585

98582



98585



98291

98291

98582 CADAQUES

pendant light; steel, black / smoked glass, black-transparent
Hängeleuchte; Stahl, schwarz / Rauchglas, schwarz-transparent
luminaire en suspension; acier, noir / verre fumé, noir transparent

H 1100, Ø 180



9 002759 985820

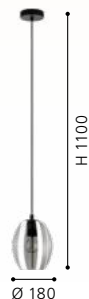

98585 CADAQUES 1

pendant light; steel, black / smoked glass, black-transparent
Hängeleuchte; Stahl, schwarz / Rauchglas, schwarz-transparent
luminaire en suspension; acier, noir / verre fumé, noir transparent

H 1100, Ø 160



9 002759 985851

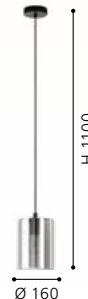

98291 TORRONTES

pendant light; steel, nickel-nero / smoked glass, black-transparent
Hängeleuchte; Stahl, nickel-nero / Rauchglas, schwarz-transparent
luminaire en suspension; acier, nickel noir / verre fumé, noir transparent

H 1100, Ø 345



9 002759 982911

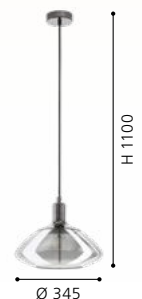



97633

97633 TINDARI

pendant light; steel, nickel-nero / glass, black-transparent, white
Hängeleuchte; Stahl, nickel-nero / Glas, schwarz-transparent, weiss

luminaire en suspension; acier, nickel noir / verre, noir transparent, blanc

H 1100, Ø 250



E27



1x 60W

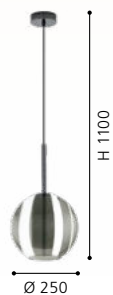

97633



98651 | 98652 | 98653 |
98654



98651

98652

98651 ARISCANI

pendant light; steel, black / glass vaporized, black-transparent
Hängeleuchte; Stahl, schwarz / Glas bedampft, schwarz-transparent
luminaire en suspension; acier, noir / verre vaporisé, noir transparent

H 1100, Ø 200

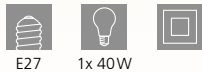

9 002759 986513



98652 ARISCANI

pendant light; steel, black / glass vaporized, black-transparent
Hängeleuchte; Stahl, schwarz / Glas bedampft, schwarz-transparent
luminaire en suspension; acier, noir / verre vaporisé, noir transparent

L 765, B 165, H 1100



9 002759 986520

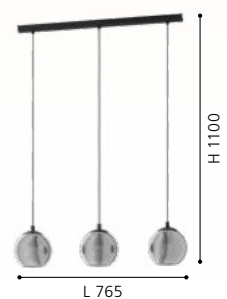



98654



98653

98654 ARISCANI

pendant light; steel, black / glass vaporized, black-transparent
 Hängeleuchte; Stahl, schwarz / Glas bedampft, schwarz-transparent
 luminaire en suspension; acier, noir / verre vaporisé, noir transparent

H 1700, Ø 655

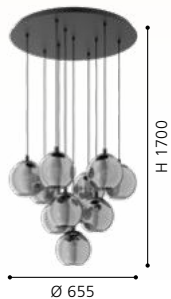

98653 ARISCANI

pendant light; steel, black / glass vaporized, black-transparent
 Hängeleuchte; Stahl, schwarz / Glas bedampft, schwarz-transparent
 luminaire en suspension; acier, noir / verre vaporisé, noir transparent

H 1100, Ø 425

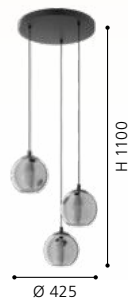



96774

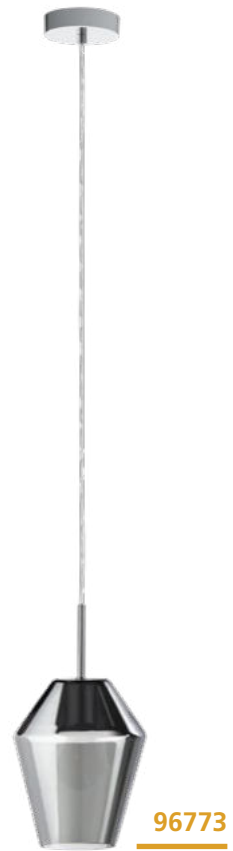

96773



96773 | 96774

96774 MURMILLO

pendant light; steel, chrome / smoked glass, black-transparent
 Hängeleuchte; Stahl, chrom / Rauchglas, schwarz-transparent
 luminaire en suspension; acier, chrome / verre fumé, noir transparent

L 770, B 170, H 1500



96773 MURMILLO

pendant light; steel, chrome / smoked glass, black-transparent
 Hängeleuchte; Stahl, chrom / Rauchglas, schwarz-transparent
 luminaire en suspension; acier, chrome / verre fumé, noir transparent

H 1500, Ø 170

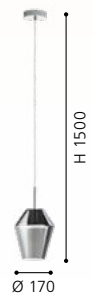



96343

LED

96344

LED

96345

LED

96343 FARSALA

pendant light; steel, satin nickel / smoked glass, granilla, black-transparent, clear

Hängeleuchte; Stahl, nickel-matt / Rauchglas, Granille, schwarz-transparent, klar

luminaire en suspension; acier, nickel mat / verre fumé, granille, noir transparent, clair

H 1100, Ø 125



G9



1x 3W



warm WHITE

1x

360lm



9 002759 963439

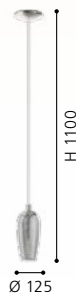

96344 FARSALA

pendant light; steel, satin nickel / smoked glass, granilla, black-transparent, clear

Hängeleuchte; Stahl, nickel-matt / Rauchglas, Granille, schwarz-transparent, klar

luminaire en suspension; acier, nickel mat / verre fumé, granille, noir transparent, clair

L 975, B 100, H 1100



G9



4x 3W



warm WHITE

4x

360lm



9 002759 963446

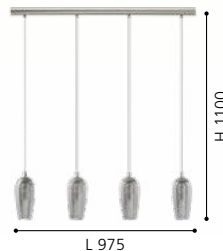

96345 FARSALA

pendant light; steel, satin nickel / smoked glass, granilla, black-transparent, clear

Hängeleuchte; Stahl, nickel-matt / Rauchglas, Granille, schwarz-transparent, klar

luminaire en suspension; acier, nickel mat / verre fumé, granille, noir transparent, clair

H 1500, Ø 350



G9



5x 3W



warm WHITE

5x

360lm



9 002759 963453





98694



98694 | 98695



98695



98696

98694 SELVINO

pendant light; steel, satin nickel / glass vaporized, black-transparent

Hängeleuchte; Stahl, nickel-matt / Glas bedampft, schwarz-transparent

luminaire en suspension; acier, nickel mat / verre vaporisé, noir transparent

H 1100, Ø 100



E27

1x 15W



9 002759 986940

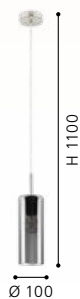

98695 SELVINO

pendant light; steel, satin nickel / glass vaporized, black-transparent

Hängeleuchte; Stahl, nickel-matt / Glas bedampft, schwarz-transparent

luminaire en suspension; acier, nickel mat / verre vaporisé, noir transparent

L 710, B 100, H 1100



E27

3x 15W



9 002759 986957



98696 SELVINO

pendant light; steel, satin nickel / glass vaporized, gold color

Hängeleuchte; Stahl, nickel-matt / Glas bedampft, goldfarben

luminaire en suspension; acier, nickel mat / verre vaporisé, couleurs d'or

H 1100, Ø 100



E27

1x 15W



9 002759 986964

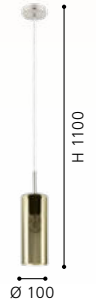



98696 | 98697 | 98698 | 98699

98697 SELVINO

pendant light; steel, satin nickel / glass vaporized, gold color
 Hängeleuchte; Stahl, nickel-matt / Glas bedampft, goldfarben
 luminaire en suspension; acier, nickel mat / verre vaporisé, couleurs d'or

L 710, B 100, H 1100



E27 3x 15W



9 002759 986971

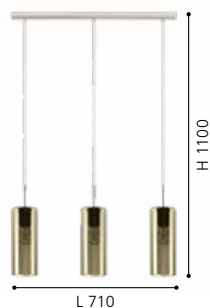

98698 SELVINO

pendant light; steel, satin nickel / glass vaporized, copper-coloured
 Hängeleuchte; Stahl, nickel-matt / Glas bedampft, kupferfarben
 luminaire en suspension; acier, nickel mat / verre vaporisé, cuivré

H 1100, Ø 100



E27 1x 15W



9 002759 986988



98699 SELVINO

pendant light; steel, satin nickel / glass vaporized, copper-coloured
 Hängeleuchte; Stahl, nickel-matt / Glas bedampft, kupferfarben
 luminaire en suspension; acier, nickel mat / verre vaporisé, cuivré

L 710, B 100, H 1100



E27 3x 15W



9 002759 986995

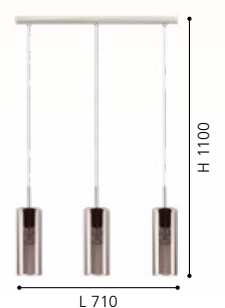



98765

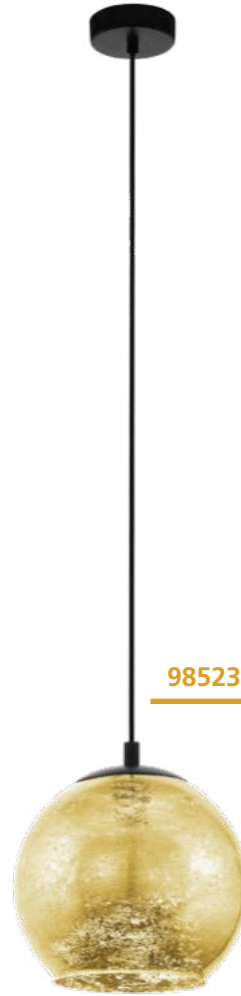

98523



98524

98765 ZABALEA

pendant light; steel, black / glass, bronze transparent
 Hängeleuchte; Stahl, schwarz / Glas, bronze-transparent
 luminaire en suspension; acier, noir / verre, bronze transparent

L 785, B 110, H 1100



E14 4x 40W



9 002759 987657

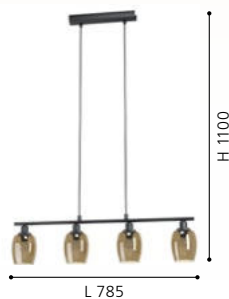

98523 ALBARACCIN

pendant light; steel, black / glass, gold color
 Hängeleuchte; Stahl, schwarz / Glas, goldfarben
 luminaire en suspension; acier, noir / verre, couleurs d'or

H 1100, Ø 270



E27 1x 40W



9 002759 985233

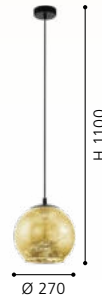

98524 ALBARACCIN

pendant light; steel, black / glass, gold color
 Hängeleuchte; Stahl, schwarz / Glas, goldfarben
 luminaire en suspension; acier, noir / verre, couleurs d'or

H 1100, Ø 190



E27 1x 40W



9 002759 985240

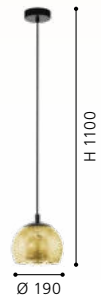



98526



98525

98526 ALBARACCIN

pendant light; steel, black / glass, gold color
 Hängeleuchte; Stahl, schwarz / Glas, goldfarben
 luminaire en suspension; acier, noir / verre, couleurs d'or

H 1500, Ø 585



E27 5x 40W



9 002759 985264

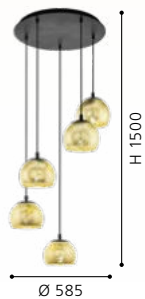

H 1500

Ø 585

98525 ALBARACCIN

pendant light; steel, black / glass, gold color
 Hängeleuchte; Stahl, schwarz / Glas, goldfarben
 luminaire en suspension; acier, noir / verre, couleurs d'or

L 780, B 190, H 1100



E27 3x 40W



9 002759 985257

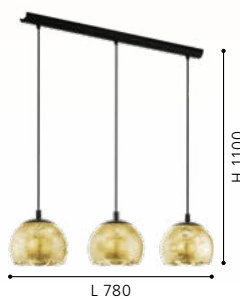

H 1100

L 780





99654

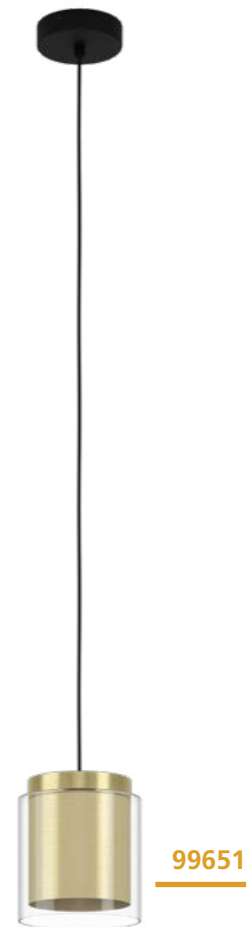

99651

99654 LAGUNITAS

pendant light; steel, black, brass, gold / glass, clear
 Hängeleuchte; Stahl, schwarz, messing, gold / Glas, klar
 luminaire en suspension; acier, noir, laiton, or / verre, clair

L 910, B 150, H 1100



E27



3x 40W



9 002759 996543



99651 LAGUNITAS

pendant light; steel, black, brass, gold / glass, clear
 Hängeleuchte; Stahl, schwarz, messing, gold / Glas, klar
 luminaire en suspension; acier, noir, laiton, or / verre, clair

H 1100, Ø 150



E27



1x 40W



9 002759 996512





99628

LED

99629

LED



99628 CERASELLA

pendant light; steel, brushed brass / glass, clear
 Hängeleuchte; Stahl, messing-gebürstet / Glas, klar
 luminaire en suspension; acier, laiton brossé / verre, clair

H 1100, Ø 200

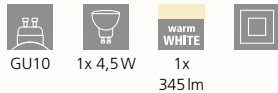

GU10 1x 4,5W 1x 345lm

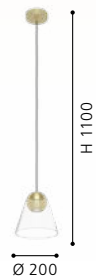

99629 CERASELLA

pendant light; steel, brushed brass / glass, clear
 Hängeleuchte; Stahl, messing-gebürstet / Glas, klar
 luminaire en suspension; acier, laiton brossé / verre, clair

L 900, B 200, H 1100

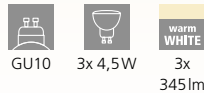

GU10 3x 4,5W 3x 345lm





94589

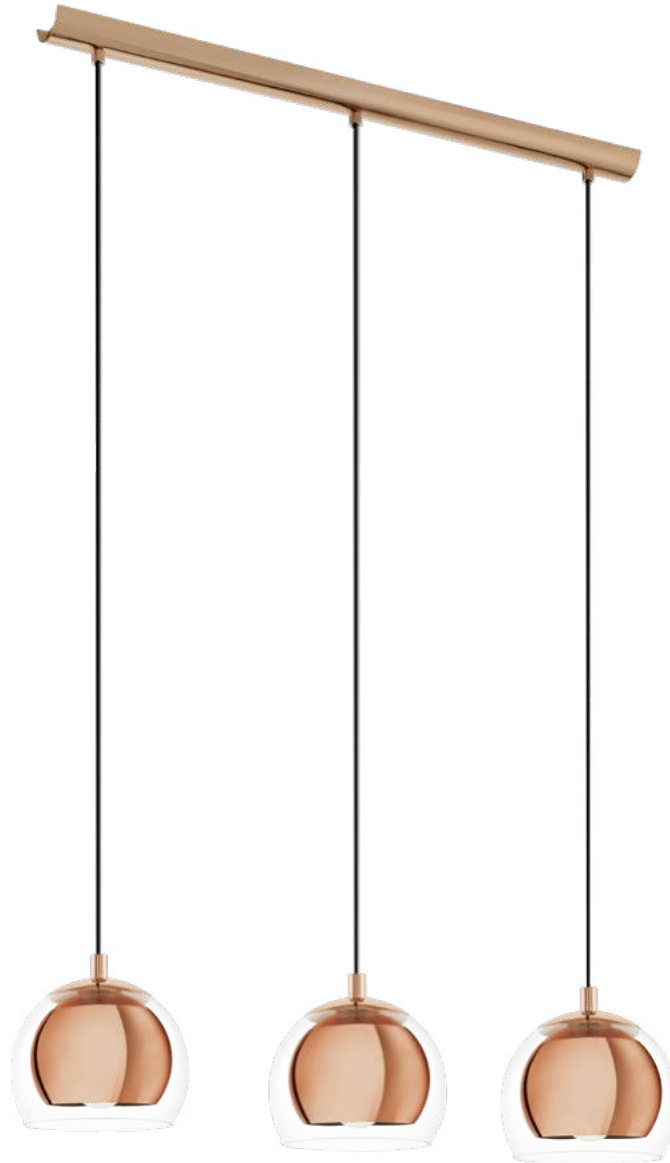

94591



94589 ROCAMAR

pendant light; steel, copper / glass, clear
Hängeleuchte; Stahl, kupfer / Glas, klar
luminaire en suspension; acier, cuivre / verre, clair

H 1100, Ø 190



E27 1x 40W



9 002759 945893

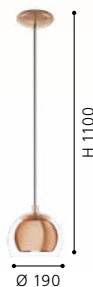

94591 ROCAMAR

pendant light; steel, copper / glass, clear
Hängeleuchte; Stahl, kupfer / Glas, klar
luminaire en suspension; acier, cuivre / verre, clair

L 780, B 190, H 1100



E27 3x 40W



9 002759 945916

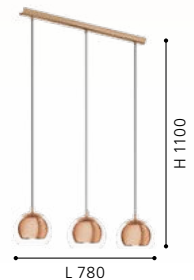



98595



93836

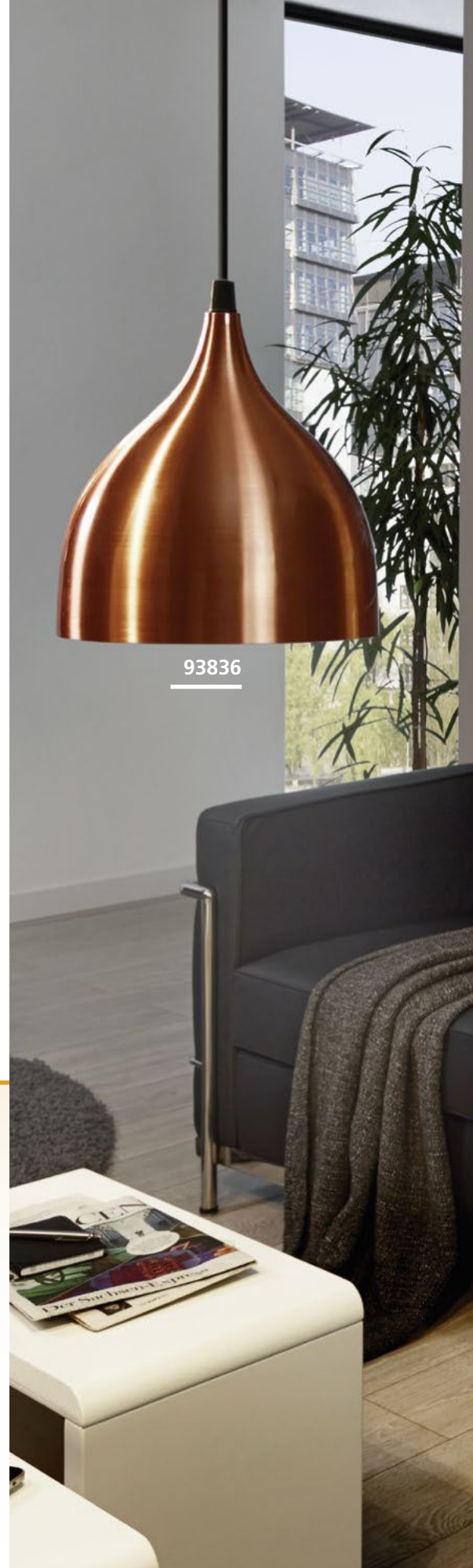

98595 ROCAMAR 1

pendant light; steel, copper / glass, clear
 Hängeleuchte; Stahl, kupfer / Glas, klar
 luminaire en suspension; acier, cuivre / verre, clair

H 1500, Ø 585

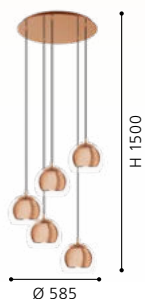

93836 CORETTO

pendant light; steel, brushed copper
 Hängeleuchte; Stahl, kupfer-gebürstet
 luminaire en suspension; acier, cuivre brossé

H 1100, Ø 170

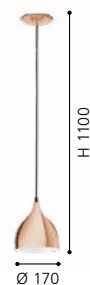
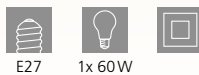



94592

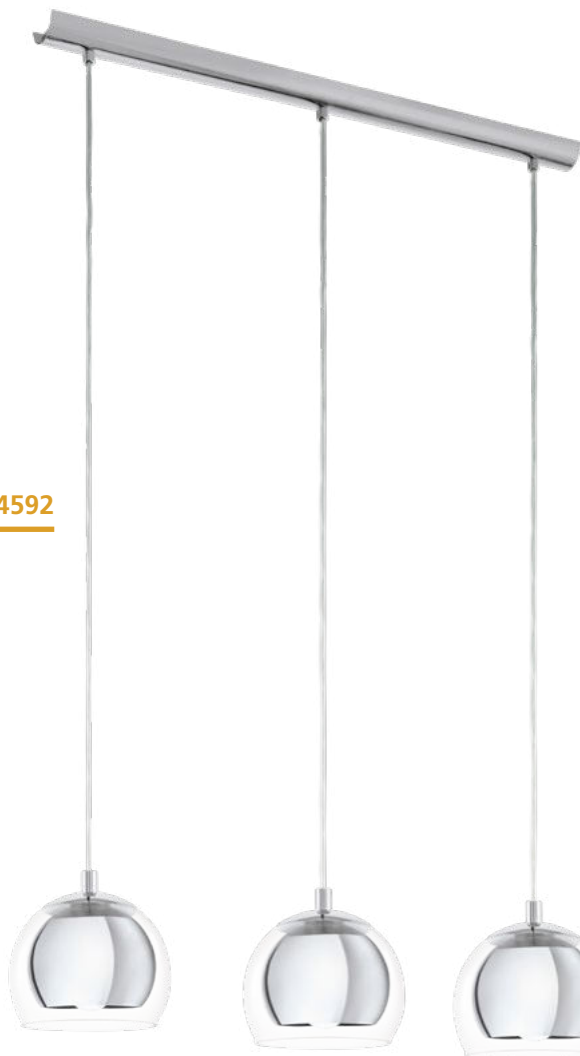

94593



98596

94592 ROCAMAR

pendant light; steel, chrome / glass, clear
Hängeleuchte; Stahl, chrom / Glas, klar
luminaire en suspension; acier, chrome / verre, clair

H 1100, Ø 190



E27

1x 40W



9 002759 945923



94593 ROCAMAR

pendant light; steel, chrome / glass, clear
Hängeleuchte; Stahl, chrom / Glas, klar
luminaire en suspension; acier, chrome / verre, clair

L 780, B 190, H 1100



E27

3x 40W



9 002759 945930

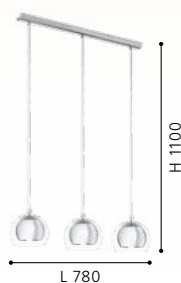

98596 ROCAMAR 1

pendant light; steel, chrome / glass, clear
Hängeleuchte; Stahl, chrom / Glas, klar
luminaire en suspension; acier, chrome / verre, clair

H 1500, Ø 585



E27

5x 28W



9 002759 985967





94378



94377

DESIGN
HIGHLIGHT
DETAIL



94377 | 94378

94378 LONCINO 1

pendant light; steel, chrome / glass, satin glass, clear, white
Hängeleuchte; Stahl, chrom / Glas, Glas satiniert, klar, weiss
luminaire en suspension; acier, chrome / verre, verre satiné, clair, blanc

L 745, B 150, H 1100



9 002759 943783

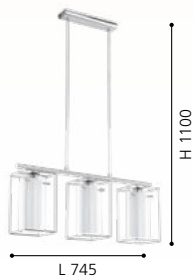

94377 LONCINO 1

pendant light; steel, chrome / glass, satin glass, clear, white
Hängeleuchte; Stahl, chrom / Glas, Glas satiniert, klar, weiss
luminaire en suspension; acier, chrome / verre, verre satiné, clair, blanc

L 150, B 150, H 1100



9 002759 943776

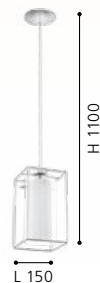



96528

LED

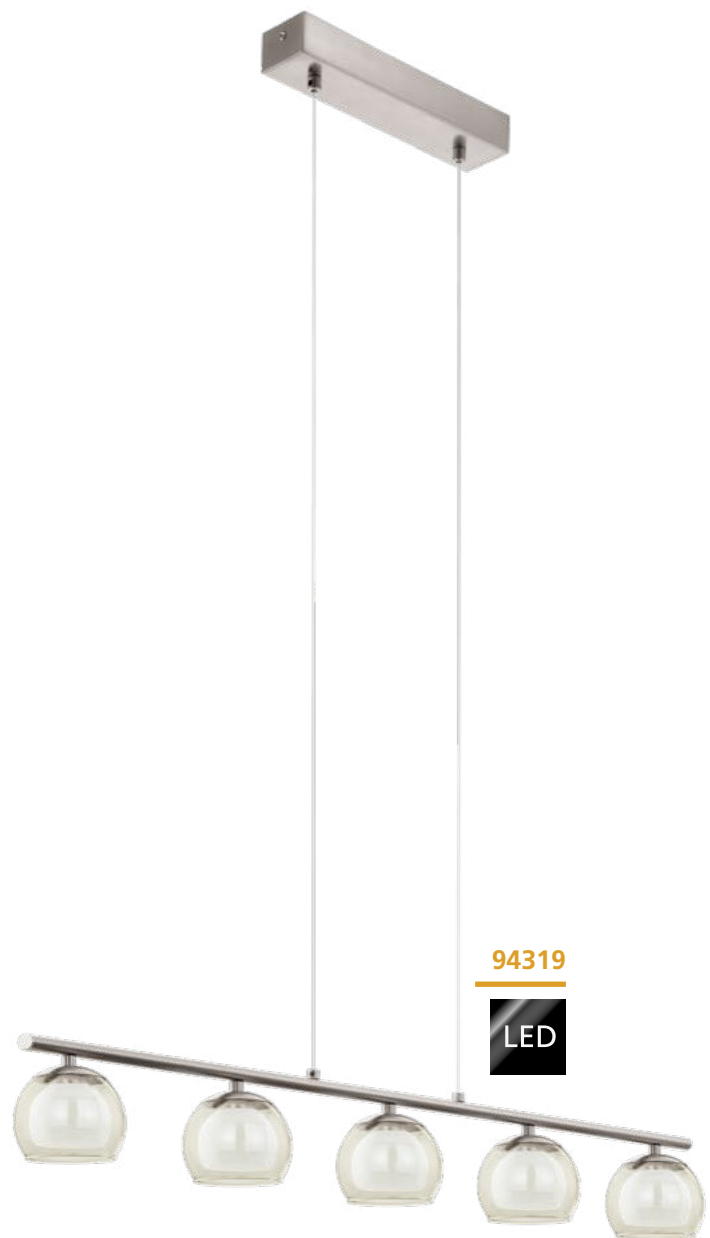

94319

LED

96528 ALEANDRO 1

pendant light; steel, chrome / glass opal-matt, white
 Hängeleuchte; Stahl, chrom / Glas opal-matt, weiss
 luminaire en suspension; acier, chrome / verre opale mat, blanc

L 800, B 120, H 860 - 1550



4x 4,5W
 4x
 500lm



9 002759 965280

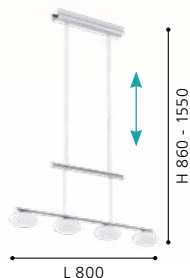

94319 ROMAGNESE

pendant light; steel, satin nickel / glass, satin glass, amber, white
 Hängeleuchte; Stahl, nickel-matt / Glas, Glas satiniert, amber, weiss
 luminaire en suspension; acier, nickel mat / verre, verre satiné, ambre, blanc

L 900, B 105, H 1100



5x 3,3W
 5x
 340lm



9 002759 943196



92761 BOLSANO

pendant light; steel, chrome / satin glass, glass, white, clear
 Hängeleuchte; Stahl, chrom / Glas satiniert, Glas, weiss, klar
 luminaire en suspension; acier, chrome / verre satiné, verre, blanc, clair

H 1300, Ø 200



E27
 1x 60W



9 002759 927615

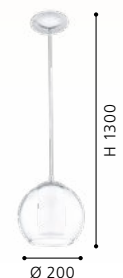



92761

92762 BOLSANO

pendant light; steel, chrome / satin glass, glass, white, clear
Hängeleuchte; Stahl, chrom / Glas satiniert, Glas, weiss, klar
luminaire en suspension; acier, chrome / verre satiné, verre,
blanc, clair

H 1300, Ø 505



E27



3x 60W



9 002759 927622

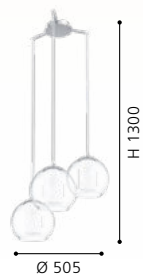

92762



93625

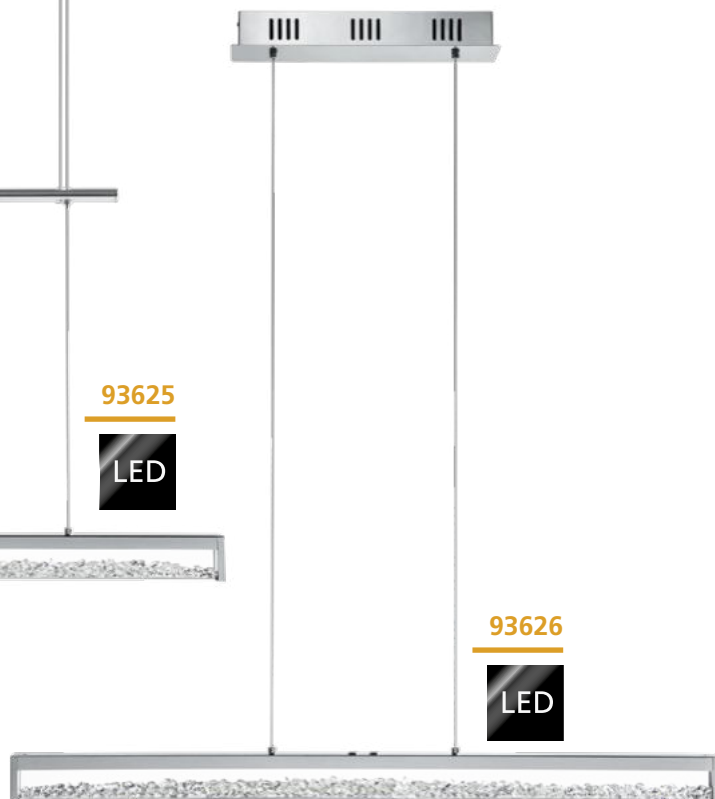

93626



93092

93092

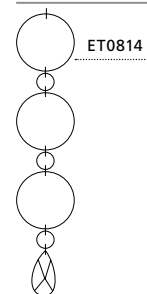

ET0814

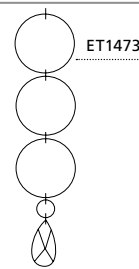

ET1473



TOUCH ME



see the tunable white video
unser Tunable White Video
notre video de blanc réglable

CARDITO 1



Warm White 2700K Neutral White Cold White 5000K

These luminaires can be switched on and off by touching the specially designed "Touch Me" part of the fixture. Features via touch-dimmer:

- > light colour adjustable between 2700 - 5000 K
- > dimmable 10% - 100%

Diese Leuchten können ein und ausgeschaltet werden, indem man sie an den dafür vorgesehenen "Touch Me" Bereichen berührt. Per Touch-Dimmer verfügen diese Leuchten über folgende Funktionen:

- > Lichtfarbe einstellbar im Bereich 2700 bis 5000 K
- > dimmbar 10% bis 100%

Ces luminaires peuvent être éteints et allumés simplement en touchant la partie spécialement conçue pour "Touch Me" du luminaire. Fonctions du gradateur "touch" :

- > couleur lumineuse réglable de 2700 - 5000 K
- > réglable en luminosité 10% - 100%

93625 CARDITO 1

pendant light; aluminium, steel, chrome / glass, crystal, clear
Hängeleuchte; Alu, Stahl, chrom / Glas, Kristall, klar
luminaire en suspension; aluminium, acier, chrome / verre, cristal, clair

L 700, B 80, H 750 - 1300



24W



2000lm



9 002759 936259

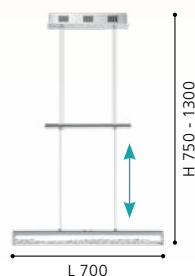

L 700

H 750 - 1300

93626 CARDITO 1

pendant light; aluminium, steel, chrome / glass, crystal, clear
Hängeleuchte; Alu, Stahl, chrom / Glas, Kristall, klar
luminaire en suspension; aluminium, acier, chrome / verre, cristal, clair

L 1000, B 80, H 1100



32W



2500lm



9 002759 936266

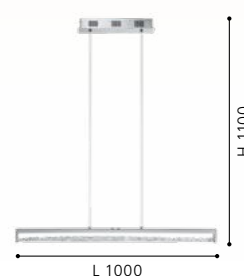

L 1000

H 1100



90696



90696



31667

LED

93092 FEDRA 2

pendant light; steel, chrome / film, crystal, mother-of-pearl, clear
Hängeleuchte; Stahl, chrom / Folie, Kristall, perlmutt, klar
luminaire en suspension; acier, chrome / film, cristal, nacré, clair

H 1100, Ø 250



E27 1x 60W



9 002759 930929



90696 DIAMOND

pendant light; steel, chrome / glass, crystal, clear, chrome
Hängeleuchte; Stahl, chrom / Glas, Kristall, klar, chrom
luminaire en suspension; acier, chrome / verre, cristal, clair, chrome

L 1010, B 105, H 1100

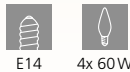

E14 4x 60W



9 002759 906962



31667 VARRAZO

pendant light; steel, chrome / crystal, clear
Hängeleuchte; Stahl, chrom / Kristall, klar
luminaire en suspension; acier, chrome / cristal, clair

H 1200, Ø 550



LED neutral WHITE 29,6W 3500lm



9 002759 316679

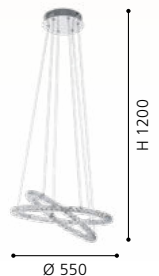



MONTEFIO 1

These luminaires come with high quality glass crystals.

Diese Leuchten sind mit hochwertigen Glaskristallen ausgestattet.

Ces luminaires viennent avec des cristaux de verre de haute qualité.



93073



93709



93073 LUBERIO

pendant light; steel, chrome / glass, aluminium, clear, aluminium
 Hängeleuchte; Stahl, chrom / Glas, Alu, klar, alu
 luminaire en suspension; acier, chrome / verre, aluminium, clair, aluminium

H 1100, Ø 250



9 002759 930738



93709 MONTEFIO 1

pendant light; steel, chrome / glass, crystal, white, clear
 Hängeleuchte; Stahl, chrom / Glas, Kristall, weiss, klar
 luminaire en suspension; acier, chrome / verre, cristal, blanc, clair

H 1100, Ø 400



9 002759 937096

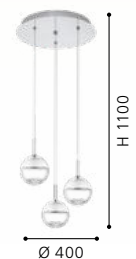



93708

LED



93784

LED

93708 MONTEFIO 1

pendant light; steel, chrome / glass, crystal, white, clear
 Hängeleuchte; Stahl, chrom / Glas, Kristall, weiss, klar
 luminaire en suspension; acier, chrome / verre, cristal, blanc, clair

H 1100, Ø 140



1x 5W
 1x
 480lm



9 002759 937089

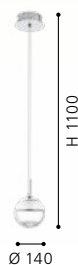

93784 MONTEFIO 1

pendant light; steel, chrome / glass, crystal, white, clear
 Hängeleuchte; Stahl, chrom / Glas, Kristall, weiss, klar
 luminaire en suspension; acier, chrome / verre, cristal, blanc, clair

L 870, B 140, H 1100



3x 5W
 3x
 480lm



9 002759 937843



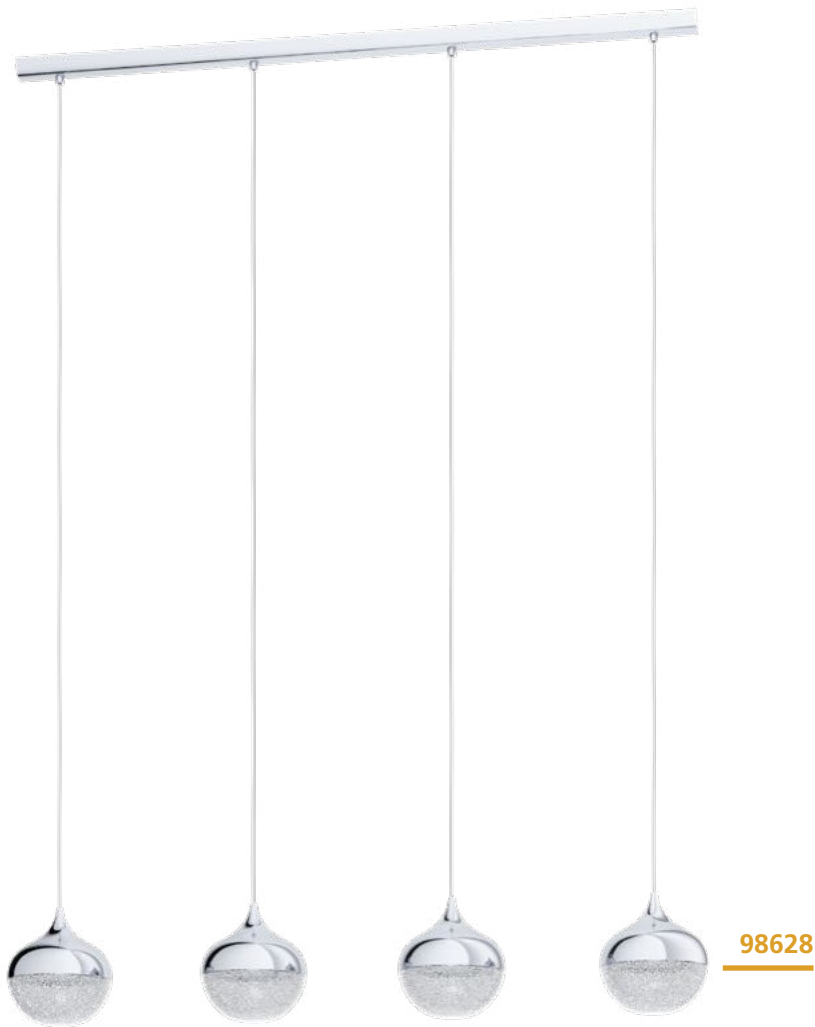

98628 | 98629

98628 MIOGLIA 1

pendant light; steel, chrome / plastic, granille white, clear
 Hängeleuchte; Stahl, chrom / Kunststoff, granille weiss, klar
 luminaire en suspension; acier, chrome / plastique, blanc granille, clair

L 975, B 150, H 1100



9 002759 986285

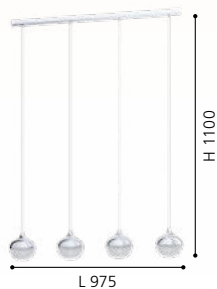

98629 MIOGLIA 1

pendant light; steel, chrome / plastic, granille white, clear
 Hängeleuchte; Stahl, chrom / Kunststoff, granille weiss, klar
 luminaire en suspension; acier, chrome / plastique, blanc granille, clair

H 1500, Ø 540



9 002759 986292



95913 CONESSA

pendant light; steel, chrome / plastic, clear
 Hängeleuchte; Stahl, chrom / Kunststoff, klar
 luminaire en suspension; acier, chrome / plastique, clair

H 1100, Ø 290

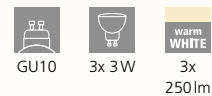

9 002759 959135





95912 CONESSA

pendant light; steel, chrome / plastic, clear
Hängeleuchte; Stahl, chrom / Kunststoff, klar
luminaire en suspension; acier, chrome / plastique, clair

L 1010, B 150, H 1100

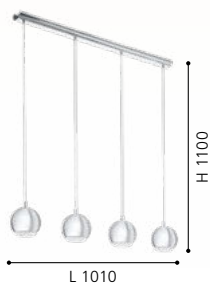
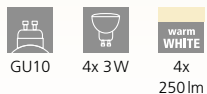

95914 CONESSA

pendant light; steel, chrome / plastic, clear
Hängeleuchte; Stahl, chrom / Kunststoff, klar
luminaire en suspension; acier, chrome / plastique, clair

H 1700, Ø 580





98678

LED



99107

LED

98678 ENALURI

pendant light; steel, satin nickel / plastic, satined
 Hängeleuchte; Stahl, nickel-matt / Kunststoff, satiniert
 luminaire en suspension; acier, nickel mat / plastique, satiné

L 140, B 105, H 1100





1x 5,4W 1x 630lm



9 002759 986780



99107 ENALURI

pendant light; steel, satin nickel / plastic, satined
 Hängeleuchte; Stahl, nickel-matt / Kunststoff, satiniert
 luminaire en suspension; acier, nickel mat / plastique, satiné

L 880, B 60, H 1100







4x 5,4W 4x 630lm

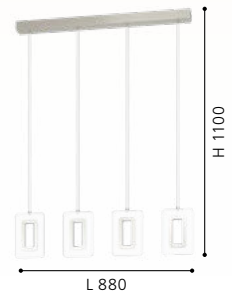

9 002759 991074

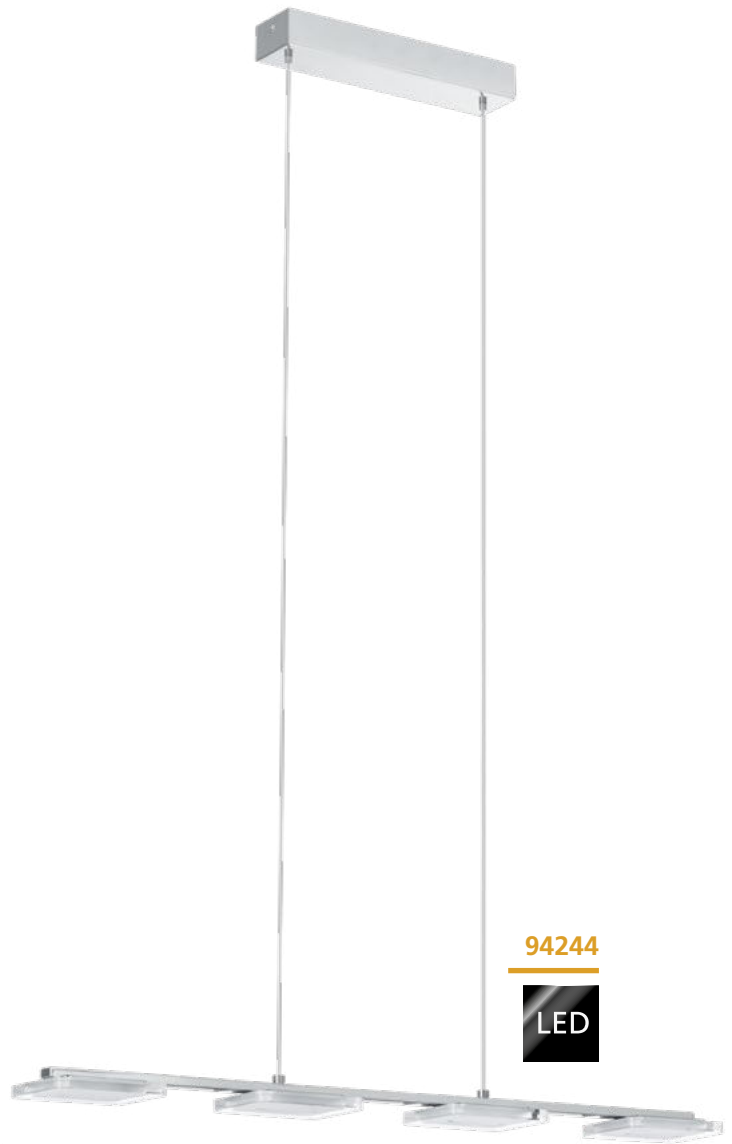
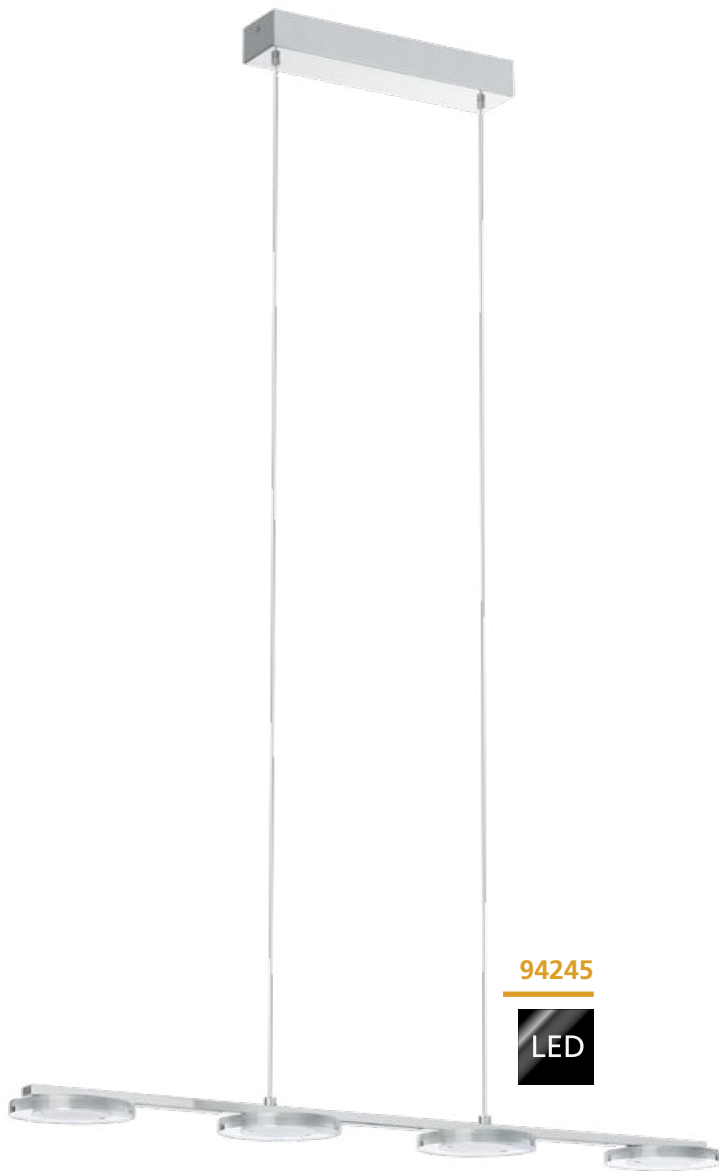



94245 CARTAMA

pendant light; steel, chrome / plastic, clear, satiné
 Hängeleuchte; Stahl, chrom / Kunststoff, klar, satiniert
 luminaire en suspension; acier, chrome / plastique, clair, satiné

L 775, B 115, H 1100



4x 4,5W
 4x
 480lm



94244 CARTAMA

pendant light; steel, chrome / plastic, clear, satiné
 Hängeleuchte; Stahl, chrom / Kunststoff, klar, satiniert
 luminaire en suspension; acier, chrome / plastique, clair, satiné

L 780, B 90, H 1100



4x 4,5W
 4x
 480lm

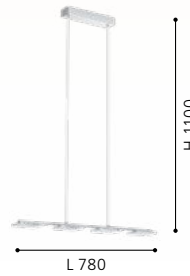



97366 MONTEFINO

pendant light; steel, black / glass, clear
 Hängeleuchte; Stahl, schwarz / Glas, klar
 luminaire en suspension; acier, noir / verre, clair

H 1100, Ø 110

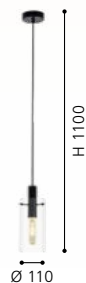

97367 MONTEFINO

pendant light; steel, black / glass, clear
 Hängeleuchte; Stahl, schwarz / Glas, klar
 luminaire en suspension; acier, noir / verre, clair

L 730, B 110, H 1100



97368 MONTEFINO

pendant light; steel, black / glass, clear
 Hängeleuchte; Stahl, schwarz / Glas, klar
 luminaire en suspension; acier, noir / verre, clair

H 1500, Ø 350





97368



98056

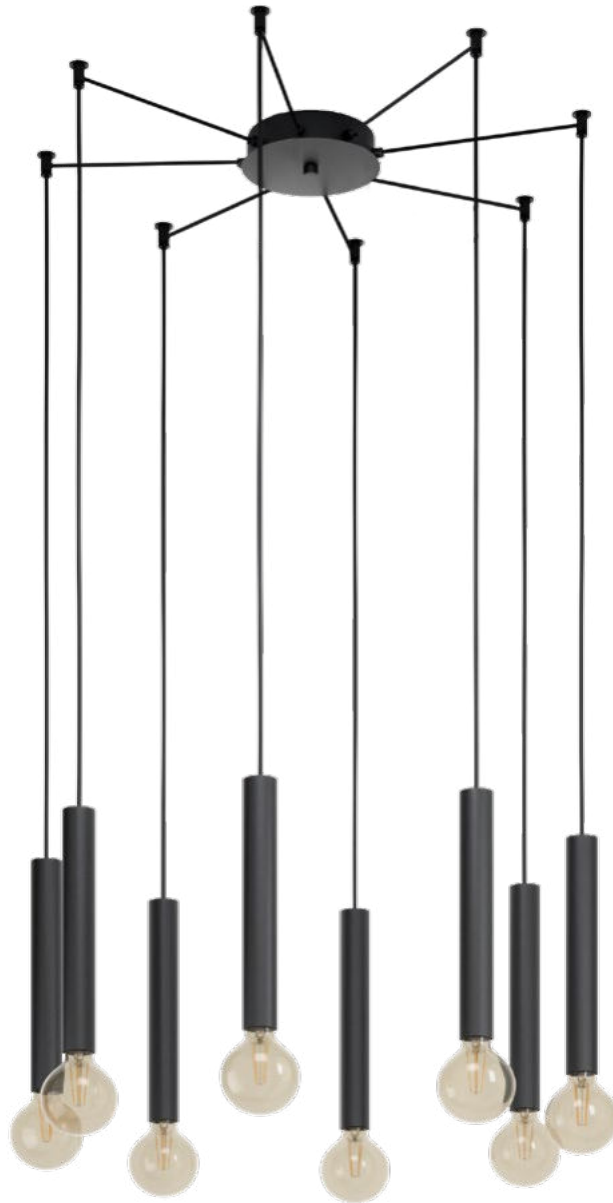

98083



98058

98056 CORTENOVA

pendant light; steel, black
Hängeleuchte; Stahl, schwarz
luminaire en suspension; acier, noir

H 1100, Ø 105



E27



1x 60W



9 002759 980566



98083 CORTENOVA

pendant light; steel, black
Hängeleuchte; Stahl, schwarz
luminaire en suspension; acier, noir

H 2000, Ø 185



E27



8x 60W



9 002759 980832



98058 CORTENOVA

pendant light; steel, black
Hängeleuchte; Stahl, schwarz
luminaire en suspension; acier, noir

H 1500, Ø 350



E27



5x 60W



9 002759 980580





98057

98057 CORTENOVA

pendant light; steel, black
Hängeleuchte; Stahl, schwarz
luminaire en suspension; acier, noir

L 840, B 60, H 1100





98661



98661 | 98662 | 98663



98663

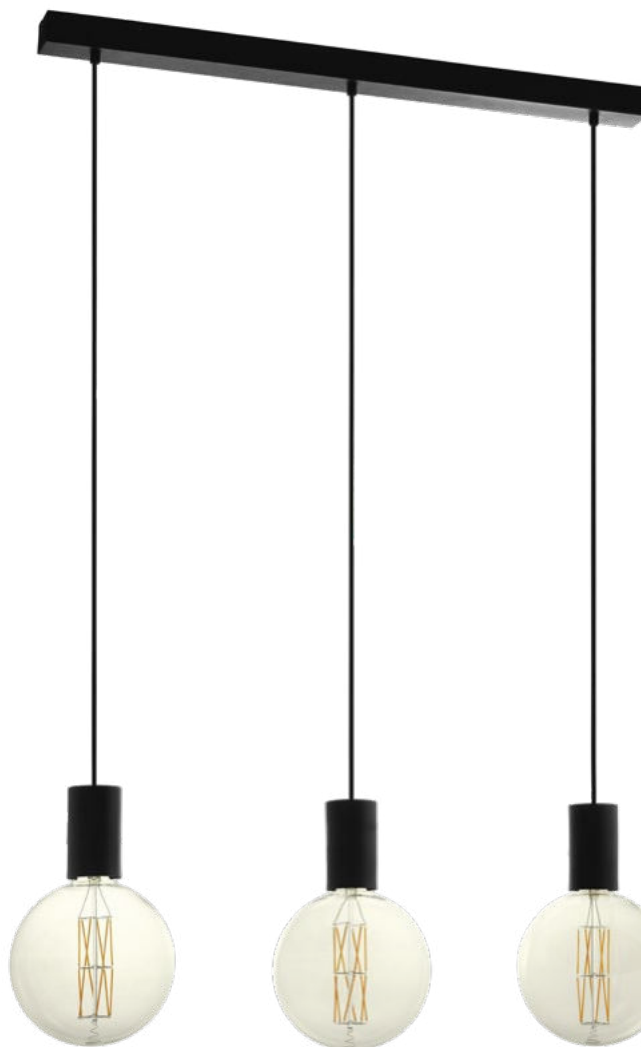

98662

98661 POZUETA

pendant light; steel, black
Hängeleuchte; Stahl, schwarz
luminaire en suspension; acier, noir

H 1100, Ø 125



E27 1x 40W



9 002759 986612

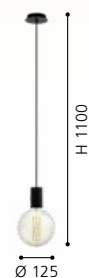

98663 POZUETA

pendant light; steel, black
Hängeleuchte; Stahl, schwarz
luminaire en suspension; acier, noir

H 1500, Ø 330



E27 3x 40W



9 002759 986636



98662 POZUETA

pendant light; steel, black
Hängeleuchte; Stahl, schwarz
luminaire en suspension; acier, noir

L 840, B 65, H 1100



E27 3x 40W



9 002759 986629





98346



98347

98346 BOCADELLA

pendant light; steel, black
 Hängeleuchte; Stahl, schwarz
 luminaire en suspension; acier, noir

H 1100, Ø 640



E27



9x 60W



9 002759 983468

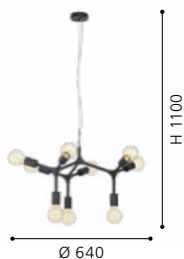

98347 BOCADELLA

pendant light; steel, black
 Hängeleuchte; Stahl, schwarz
 luminaire en suspension; acier, noir

H 1100, Ø 920



E27



12x 60W



9 002759 983475

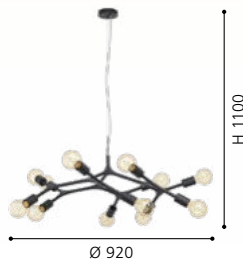

98909 MEZZANA

pendant light; steel, black
 Hängeleuchte; Stahl, schwarz
 luminaire en suspension; acier, noir

L 650, B 650, H 1100



E27



8x 40W



9 002759 989095





98909



98017



98016



99811

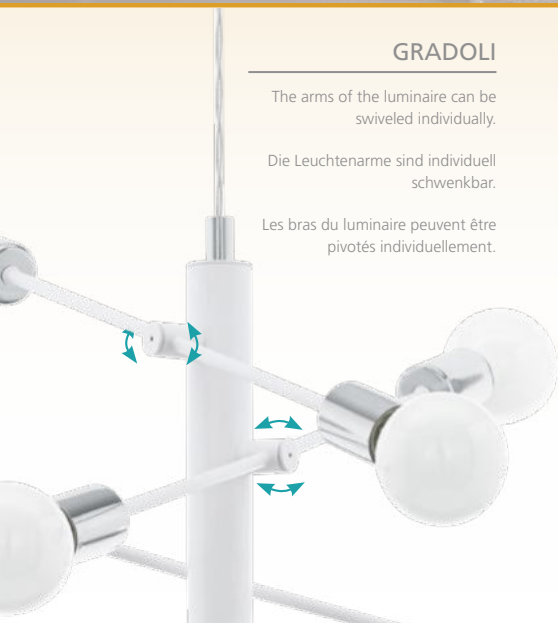

GRADOLI

The arms of the luminaire can be swiveled individually.

Die Leuchtenarme sind individuell schwenkbar.

Les bras du luminaire peuvent être pivotés individuellement.

98017 GRADOLI

pendant light; steel, white, chrome
Hängeleuchte; Stahl, weiss, chrom
luminaire en suspension; acier, blanc, chrome

H 1100, Ø 710

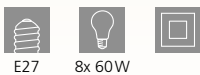

9 002759 980177

98016 GRADOLI

pendant light; steel, white, chrome
Hängeleuchte; Stahl, weiss, chrom
luminaire en suspension; acier, blanc, chrome

H 1100, Ø 550



9 002759 980160

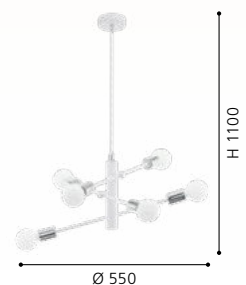



98835



98834 | 98835



98834

99811 GRADOLI 1

pendant light; steel, brushed brass
Hängeleuchte; Stahl, messing-gebürstet
luminaire en suspension; acier, laiton brossé

H 1100, Ø 710

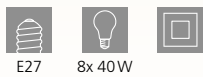

E27 8x 40W



9 002759 998110

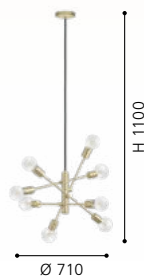

98835 MANIZALES

pendant light; steel, brushed brass
Hängeleuchte; Stahl, messing-gebürstet
luminaire en suspension; acier, laiton brossé

L 1010, B 50, H 1100



E27 3x 40W



9 002759 988357

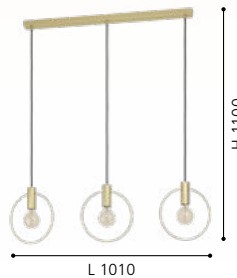

98834 MANIZALES

pendant light; steel, brushed brass
Hängeleuchte; Stahl, messing-gebürstet
luminaire en suspension; acier, laiton brossé

L 250, B 105, H 1100



E27 1x 40W



9 002759 988340

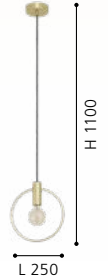



97734 MONTEBALDO

pendant light; steel, black, gold
 Hängeleuchte; Stahl, schwarz, gold
 luminaire en suspension; acier, noir, or

L 850, B 100, H 1100

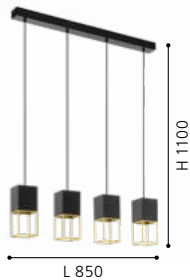
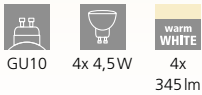

97733 MONTEBALDO

pendant light; steel, black, gold
 Hängeleuchte; Stahl, schwarz, gold
 luminaire en suspension; acier, noir, or

L 100, B 100, H 1100

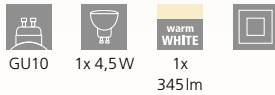

98858 BITACHITO

pendant light; steel, black, brass
 Hängeleuchte; Stahl, schwarz, messing
 luminaire en suspension; acier, noir, laiton

L 930, B 55, H 1100

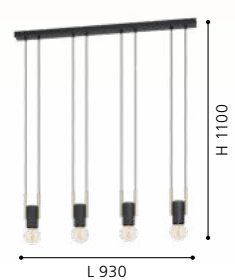



99531



99531 | 99532



99532

99531 LOBATIA

pendant light; steel, wood, black / terrazzo, grey, white
 Hängeleuchte; Stahl, Holz, schwarz / Terrazzo, grau, weiss
 luminaire en suspension; acier, bois, noir / terrazzo, gris, blanc

H 1100, Ø 105



99532 LOBATIA

pendant light; steel, wood, black / terrazzo, grey, white
 Hängeleuchte; Stahl, Holz, schwarz / Terrazzo, grau, weiss
 luminaire en suspension; acier, bois, noir / terrazzo, gris, blanc

L 925, B 55, H 1100



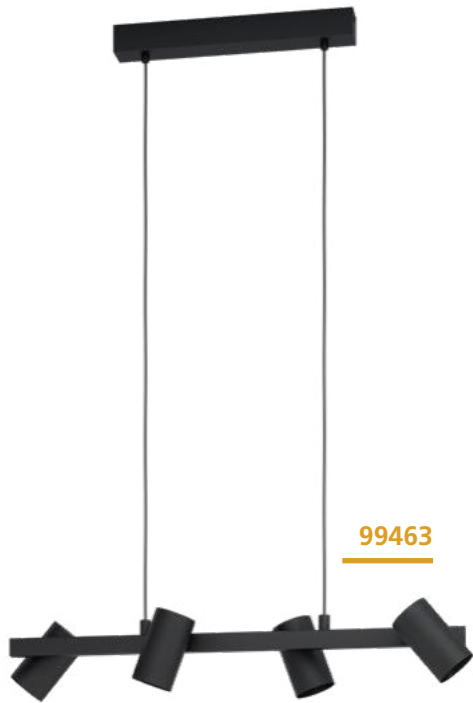

99463



99464

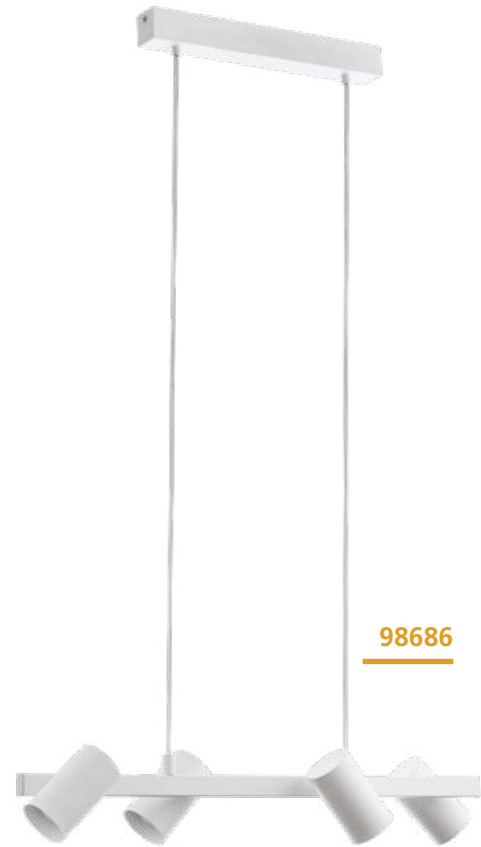

98686

99463 GATUELA 1

pendant light; steel, black
Hängeleuchte; Stahl, schwarz
luminaire en suspension; acier, noir

L 760, B 190, H 1100



E14

4x 25W



9 002759 994631



L 760

H 1100

99464 GATUELA 1

pendant light; steel, black
Hängeleuchte; Stahl, schwarz
luminaire en suspension; acier, noir

L 1160, B 190, H 1100



E14

6x 25W



9 002759 994648

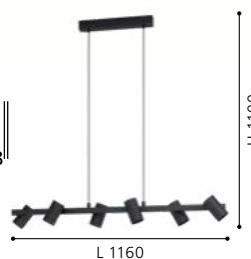

L 1160

H 1100

98686 GATUELA

pendant light; steel, white, satin nickel
Hängeleuchte; Stahl, weiss, nickel-matt
luminaire en suspension; acier, blanc, nickel mat

L 760, B 190, H 1100



E14

4x 25W



9 002759 986865

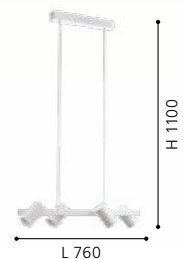

L 760

H 1100



98687 GATUELA

pendant light; steel, white, satin nickel
 Hängeleuchte; Stahl, weiss, nickel-matt
 luminaire en suspension; acier, blanc, nickel mat

L 1160, B 190, H 1100

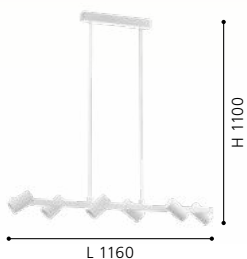

99819 ROVIRA

pendant light; aluminium, steel, silver / plastic, white
 Hängeleuchte; Alu, Stahl, silber / Kunststoff, weiss
 luminaire en suspension; aluminium, acier, argent / plastique, blanc

L 770, B 50, H 1100

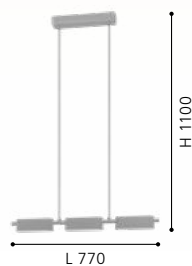

99821 ROVIRA

pendant light; aluminium, steel, black / plastic, white
 Hängeleuchte; Alu, Stahl, schwarz / Kunststoff, weiss
 luminaire en suspension; aluminium, acier, noir / plastique, blanc

L 770, B 50, H 1100

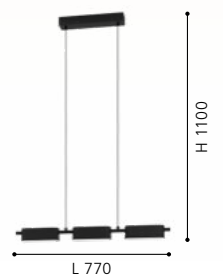



98441



EGLO
RECOMMENDS
11595

98192 | 98441

98192

98441 CAMARGO

pendant light; steel, black / glass opal-matt, white
Hängeleuchte; Stahl, schwarz / Glas opal-matt, weiss
luminaire en suspension; acier, noir / verre opale mat, blanc

H 1500, Ø 350



E14 3x 40W



9 002759 984410



98192 CAMARGO

pendant light; steel, black / glass opal-matt, white
Hängeleuchte; Stahl, schwarz / Glas opal-matt, weiss
luminaire en suspension; acier, noir / verre opale mat, blanc

L 350, B 200, H 1500



E27 1x 40W



9 002759 981921

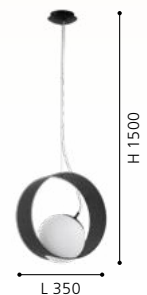

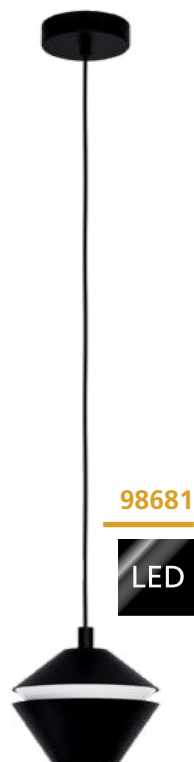

98681

LED



98682

LED

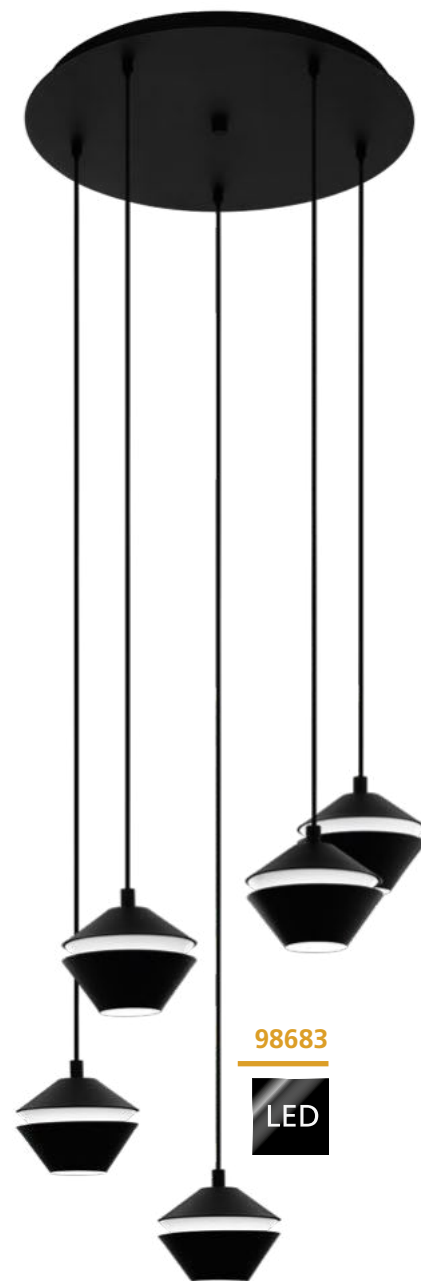

98683

LED

98681 PERPIGO

pendant light; steel, black / plastic, white
 Hängeleuchte; Stahl, schwarz / Kunststoff, weiss
 luminaire en suspension; acier, noir / plastique, blanc

H 1100, Ø 165

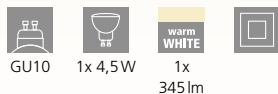

GU10 1x 4,5W 1x 345lm



9 002759 986810

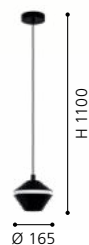

98682 PERPIGO

pendant light; steel, black / plastic, white
 Hängeleuchte; Stahl, schwarz / Kunststoff, weiss
 luminaire en suspension; acier, noir / plastique, blanc

L 865, B 165, H 1100



GU10 3x 4,5W 3x 345lm



9 002759 986827

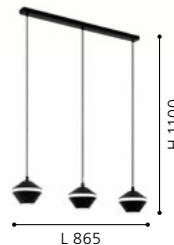

98683 PERPIGO

pendant light; steel, black / plastic, white
 Hängeleuchte; Stahl, schwarz / Kunststoff, weiss
 luminaire en suspension; acier, noir / plastique, blanc

H 1500, Ø 555

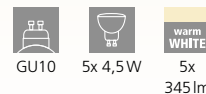

GU10 5x 4,5W 5x 345lm



9 002759 986834

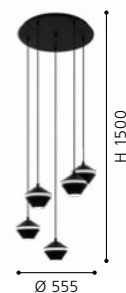



98492 AMONTILLADO

pendant light; aluminium, steel, black / plastic, white
 Hängeleuchte; Alu, Stahl, schwarz / Kunststoff, weiss
 luminaire en suspension; aluminium, acier, noir / plastique, blanc

L 1160, B 85, H 1100

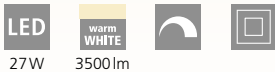

27W 3500lm



9 002759 984922

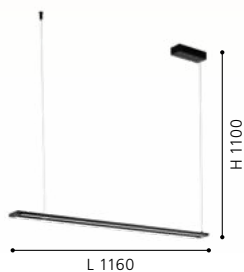

99599 CAMBULOS

pendant light; steel, black / plastic, white
 Hängeleuchte; Stahl, schwarz / Kunststoff, weiss
 luminaire en suspension; acier, noir / plastique, blanc

L 935, B 105, H 1100



2x 17W 4000lm



9 002759 995997



98495 SPADAFORA

pendant light; aluminium, steel, black / plastic, clear, white
 Hängeleuchte; Alu, Stahl, schwarz / Kunststoff, klar, weiss
 luminaire en suspension; aluminium, acier, noir / plastique, clair, blanc

L 1160, B 80, H 1100



14,5W 2050lm



9 002759 984953

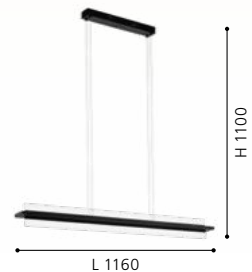



98836



98836 ERMUA

pendant light; steel, wood, black, brown / plastic, white
Hängeleuchte; Stahl, Holz, schwarz, braun / Kunststoff, weiss
luminaire en suspension; acier, bois, noir, marron / plastique, blanc

L 1000, B 165, H 1100

LED

27W

warm
WHITE

3850lm



9 002759 988364



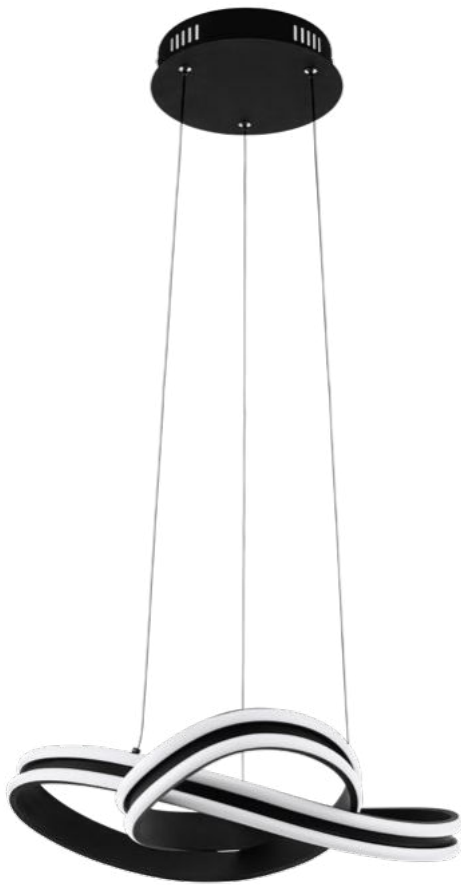

99249

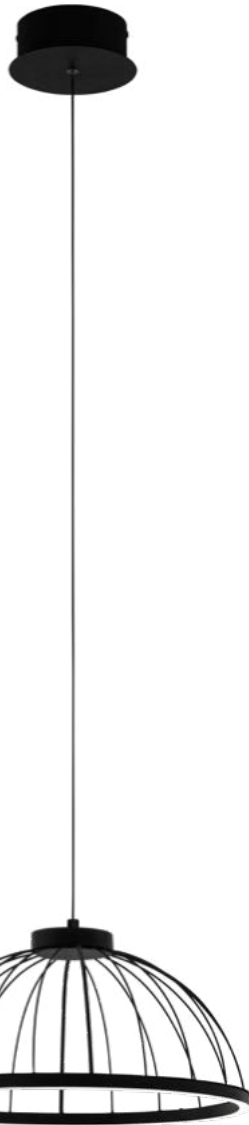

99401

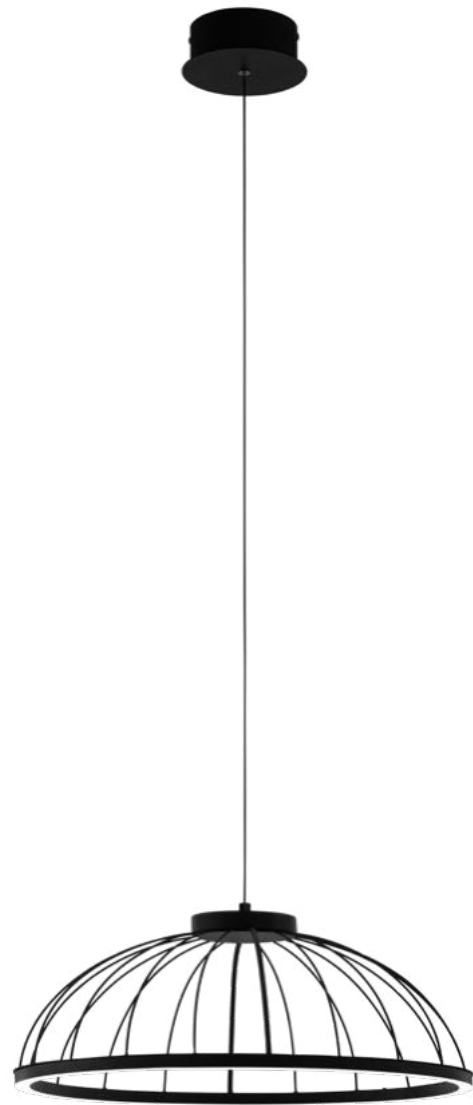

99403



99249 CORREDERA

pendant light; steel, black / plastic, white
 Hängeleuchte; Stahl, schwarz / Kunststoff, weiss
 luminaire en suspension; acier, noir / plastique, blanc

H 1200, Ø 500



2x 18W



2x
2500lm



9 002759 992491

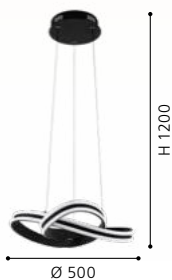

99401 BOGOTENILLO

pendant light; steel, black / plastic, white
 Hängeleuchte; Stahl, schwarz / Kunststoff, weiss
 luminaire en suspension; acier, noir / plastique, blanc

H 1200, Ø 400



22W



2750lm



9 002759 994013



99403 BOGOTENILLO

pendant light; steel, black / plastic, white
 Hängeleuchte; Stahl, schwarz / Kunststoff, weiss
 luminaire en suspension; acier, noir / plastique, blanc

H 1200, Ø 500



27W



3400lm



9 002759 994037

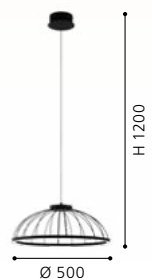



99358



99818



99358 CODRIALES

pendant light; steel, black / plastic, white
 Hängeleuchte; Stahl, schwarz / Kunststoff, weiss
 luminaire en suspension; acier, noir / plastique, blanc

L 780, B 300, H 1100



30W 3700lm



9 002759 993580



99818 SALITRE

pendant light; aluminium, black / plastic, white
 Hängeleuchte; Alu, schwarz / Kunststoff, weiss
 luminaire en suspension; aluminium, noir / plastique, blanc

H 1100, Ø 730



29W 4000lm



9 002759 998189

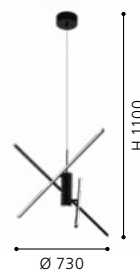



99081



99082

99083



99081 | 99082 | 99083

99081 VALECROSIA

pendant light; steel, black, white
Hängeleuchte; Stahl, schwarz, weiss
luminaire en suspension; acier, noir, blanc

H 1100, Ø 420

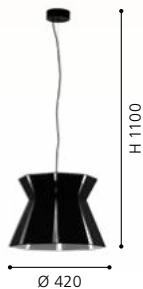
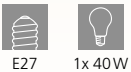

99082 VALECROSIA

pendant light; steel, black, white
Hängeleuchte; Stahl, schwarz, weiss
luminaire en suspension; acier, noir, blanc

L 180, B 180, H 1100



99083 VALECROSIA

pendant light; steel, black, white
Hängeleuchte; Stahl, schwarz, weiss
luminaire en suspension; acier, noir, blanc

L 840, B 180, H 1100

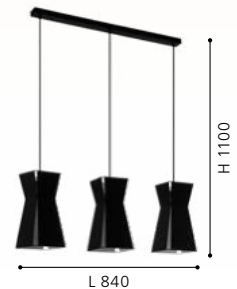

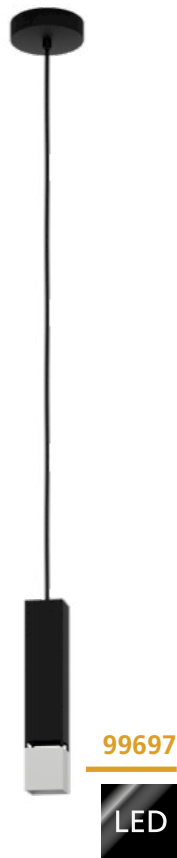

99697

LED



99698

LED

99697 BUTRANO

pendant light; steel, black, silver
 Hängeleuchte; Stahl, schwarz, silber
 luminaire en suspension; acier, noir, argent

L 55, B 55, H 1100

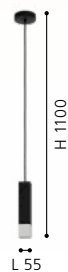
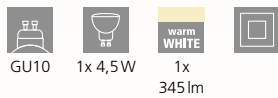

99698 BUTRANO

pendant light; steel, black, silver
 Hängeleuchte; Stahl, schwarz, silber
 luminaire en suspension; acier, noir, argent

L 770, B 55, H 1100

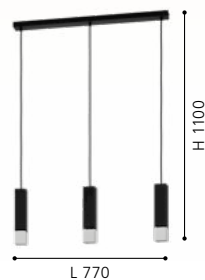
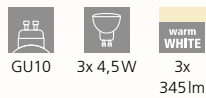



99073



99071

99072

99073 MIRTAZZA

pendant light; steel, black / steel, champagne
Hängeleuchte; Stahl, schwarz / Stahl, champagner
luminaire en suspension; acier, noir / acier, champagne

H 1100, Ø 590



9 002759 990732



99071 MIRTAZZA

pendant light; steel, black / steel, champagne
Hängeleuchte; Stahl, schwarz / Stahl, champagner
luminaire en suspension; acier, noir / acier, champagne

H 1100, Ø 180

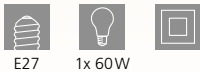

9 002759 990718



99072 MIRTAZZA

pendant light; steel, black / steel, champagne
Hängeleuchte; Stahl, schwarz / Stahl, champagner
luminaire en suspension; acier, noir / acier, champagne

L 880, B 180, H 1100



9 002759 990725

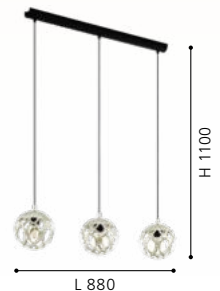



98688



98689



97066

98688 OKINZURI

pendant light; steel, nickel-nero
Hängeleuchte; Stahl, nickel-nero
luminaire en suspension; acier, nickel noir

H 1100, Ø 450



E27 1x 60W



9 002759 986889

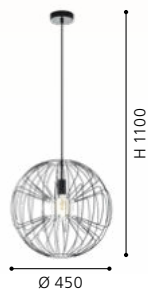

98689 OKINZURI

pendant light; steel, brass
Hängeleuchte; Stahl, messing
luminaire en suspension; acier, laiton

H 1100, Ø 450



E27 1x 60W



9 002759 986896



97066 ESTEVAU

pendant light; steel, dark brown
Hängeleuchte; Stahl, dunkelbraun
luminaire en suspension; acier, marron foncé

L 975, B 145, H 1100



E27 4x 60W



9 002759 970666





92251



92252



92251 | 92252 | 94388 | 94389

92251 RAZONI

pendant light; steel, white / satin glass, steel, white
Hängeleuchte; Stahl, weiss / Glas satiniert, Stahl, weiss
luminaire en suspension; acier, blanc / verre satiné, acier, blanc

H 1300, Ø 190



E27



1x 60W



9 002759 922511





92252 RAZONI

pendant light; steel, black / satin glass, steel, black, white
 Hängeleuchte; Stahl, schwarz / Glas satiniert, Stahl, schwarz, weiss
 luminaire en suspension; acier, noir / verre satiné, acier, noir, blanc

H 1300, Ø 190



94388 RAZONI

pendant light; steel, white / satin glass, steel, white
 Hängeleuchte; Stahl, weiss / Glas satiniert, Stahl, weiss
 luminaire en suspension; acier, blanc / verre satiné, acier, blanc

L 990, B 190, H 1100



94389 RAZONI

pendant light; steel, black / satin glass, steel, black, white
 Hängeleuchte; Stahl, schwarz / Glas satiniert, Stahl, schwarz, weiss
 luminaire en suspension; acier, noir / verre satiné, acier, noir, blanc

L 990, B 190, H 1100





99635 | 99636

99634

99636

DESIGN
HIGHLIGHT
DETAIL

99634 MASETA

pendant light; steel, black / smoked glass, black-transparent
Hängeleuchte; Stahl, schwarz / Rauchglas, schwarz-transparent
luminaire en suspension; acier, noir / verre fumé, noir transparent

L 930, B 225, H 1100

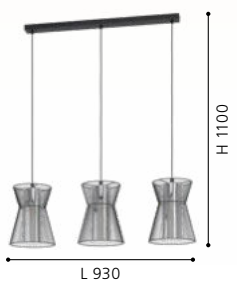

99636 MASETA

pendant light; steel, gold-coloured / glass opal-matt, white
Hängeleuchte; Stahl, goldfarben / Glas opal-matt, weiss
luminaire en suspension; acier, doré / verre opale mat, blanc

L 930, B 225, H 1100

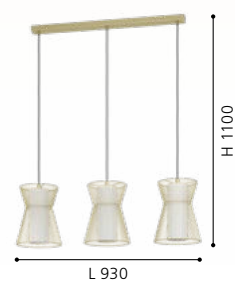

99633 MASETA

pendant light; steel, black / smoked glass, black-transparent
Hängeleuchte; Stahl, schwarz / Rauchglas, schwarz-transparent
luminaire en suspension; acier, noir / verre fumé, noir transparent

H 1100, Ø 225

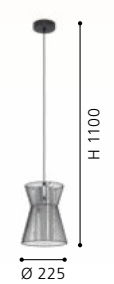
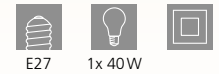

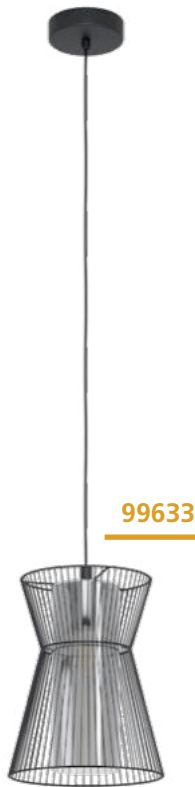

99633 | 99634



99635 MASETA

pendant light; steel, gold-coloured / glass opal-matt, white
Hängeleuchte; Stahl, goldfarben / Glas opal-matt, weiss
luminaire en suspension; acier, doré / verre opale mat, blanc

H 1100, Ø 225



E27



1x 40W

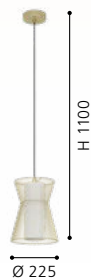



99705 FLORESTA

pendant light; steel, black / glass vaporized, black-transparent
 Hängeleuchte; Stahl, schwarz / Glas bedampft, schwarz-transparent
 luminaire en suspension; acier, noir / verre vaporisé, noir transparent

H 1100, Ø 195

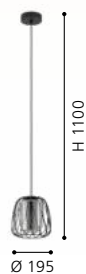

99706 FLORESTA

pendant light; steel, black / glass vaporized, black-transparent
 Hängeleuchte; Stahl, schwarz / Glas bedampft, schwarz-transparent
 luminaire en suspension; acier, noir / verre vaporisé, noir transparent

L 890, B 190, H 1100



99707 ZOCABON

pendant light; steel, black / glass, clear
 Hängeleuchte; Stahl, schwarz / Glas, klar
 luminaire en suspension; acier, noir / verre, clair

L 815, B 110, H 1100





99619



99618

99619 MULEGES

pendant light; steel, black / glass opal-matt, white
 Hängeleuchte; Stahl, schwarz / Glas opal-matt, weiss
 luminaire en suspension; acier, noir / verre opale mat, blanc

L 960, B 160, H 1100



99618 MULEGES

pendant light; steel, black / glass opal-matt, white
 Hängeleuchte; Stahl, schwarz / Glas opal-matt, weiss
 luminaire en suspension; acier, noir / verre opale mat, blanc

H 1100, Ø 160

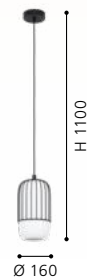



99661



99662

99661 CURASAO

pendant light; steel, black / steel, fabric, black, gold
 Hängeleuchte; Stahl, schwarz / Stahl, Textil, schwarz, gold
 luminaire en suspension; acier, noir / acier, tissu, noir, or

H 1100, Ø 335

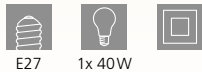

E27 1x 40W



9 002759 996611



99662 CURASAO

pendant light; steel, black / steel, fabric, black, gold
 Hängeleuchte; Stahl, schwarz / Stahl, Textil, schwarz, gold
 luminaire en suspension; acier, noir / acier, tissu, noir, or

L 995, B 235, H 1100



E27 3x 40W



9 002759 996628





99665

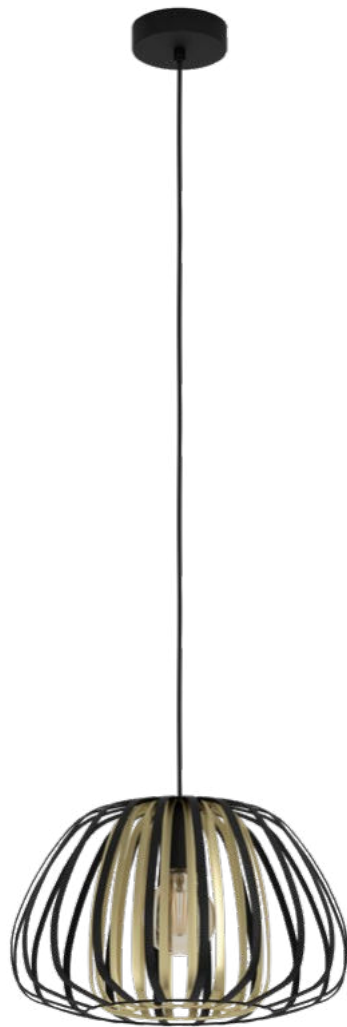

99666



99665 ENCINITOS

pendant light; steel, black, gold
Hängeleuchte; Stahl, schwarz, gold
luminaire en suspension; acier, noir, or

H 1100, Ø 255



E27 1x 40W



9 002759 996659

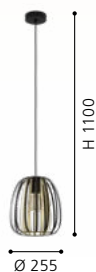

99666 ENCINITOS

pendant light; steel, black, gold
Hängeleuchte; Stahl, schwarz, gold
luminaire en suspension; acier, noir, or

H 1100, Ø 375



E27 1x 40W



9 002759 996666





99694

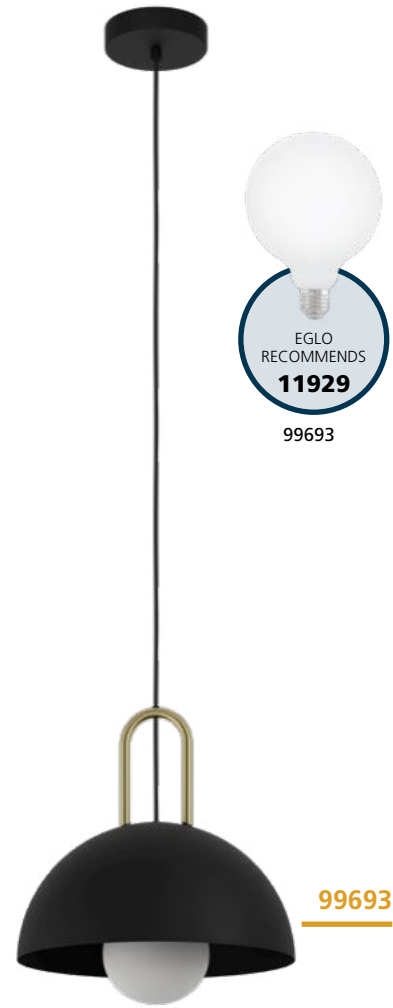

99693

99693

99694 CALMANERA

pendant light; steel, black, brass
 Hängeleuchte; Stahl, schwarz, messing
 luminaire en suspension; acier, noir, laiton

L 900, B 200, H 1100

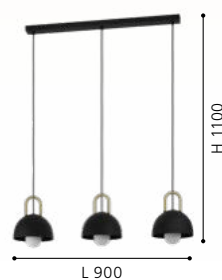

99693 CALMANERA

pendant light; steel, black, brass
 Hängeleuchte; Stahl, schwarz, messing
 luminaire en suspension; acier, noir, laiton

H 1100, Ø 325

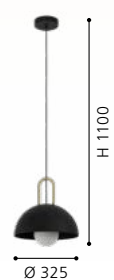



99695 | 99696

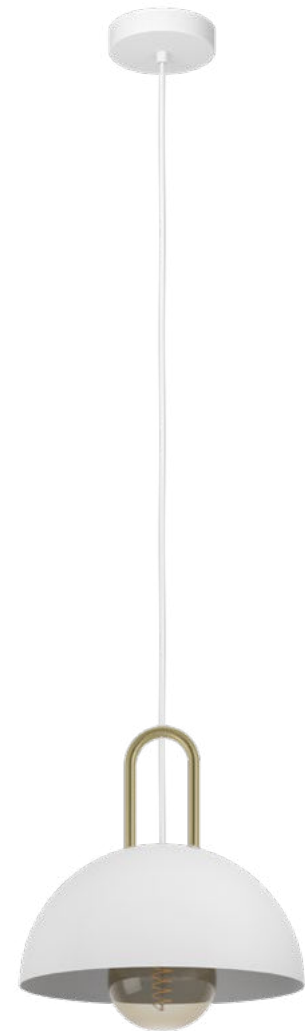

99695

99696 CALMANERA

pendant light; steel, white, brass
 Hängeleuchte; Stahl, weiss, messing
 luminaire en suspension; acier, blanc, laiton

L 900, B 200, H 1100

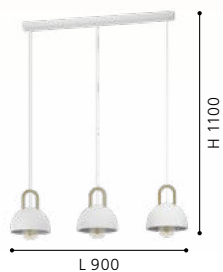

99695 CALMANERA

pendant light; steel, white, brass
 Hängeleuchte; Stahl, weiss, messing
 luminaire en suspension; acier, blanc, laiton

H 1100, Ø 325

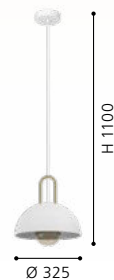



DESIGN
HIGHLIGHT
DETAIL



98839



98839 LOSALOMAS

pendant light; steel, Mokka colour, brushed brass
Hängeleuchte; Stahl, Mokkafarben, messing-gebürstet
luminaire en suspension; acier, mocha couleur, laiton brossé

L 835, B 135, H 1100

GU10
 3x 4,5W
 warm WHITE
 3x 345lm



98838 LOSALOMAS

pendant light; steel, Mokka colour, brushed brass
Hängeleuchte; Stahl, Mokkafarben, messing-gebürstet
luminaire en suspension; acier, mocha couleur, laiton brossé

H 1100, Ø 135

GU10
 1x 4,5W
 warm WHITE

 1x 345lm

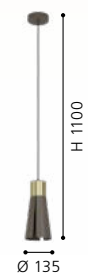



98838

LED



99439





99438



99439 SEGEZIA

pendant light; steel, Mokka colour / steel, Mokka colour, gold
 Hängeleuchte; Stahl, Mokkafarben / Stahl, Mokka, gold
 luminaire en suspension; acier, mocha couleur / acier, Mokka, or

H 1100, Ø 350



99438 SEGEZIA

pendant light; steel, Mokka colour / steel, Mokka colour, gold
 Hängeleuchte; Stahl, Mokkafarben / Stahl, Mokka, gold
 luminaire en suspension; acier, mocha couleur / acier, Mokka, or

L 880, B 180, H 1100



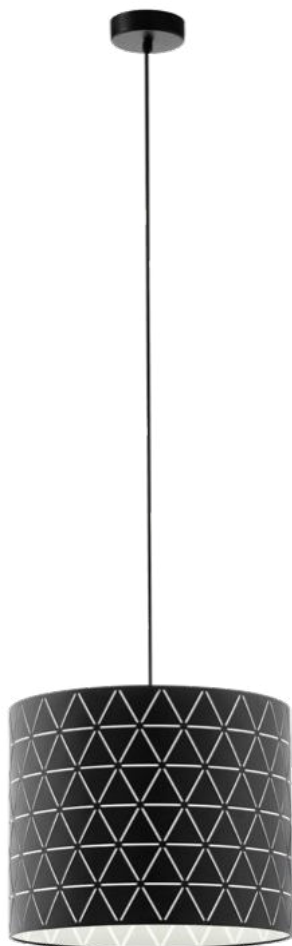

98351



98352



98353

98351 RAMON

pendant light; steel, black / film, white
Hängeleuchte; Stahl, schwarz / Folie, weiss
luminaire en suspension; acier, noir / film, blanc

H 1100, Ø 370



E27 1x 40W



9 002759 983512

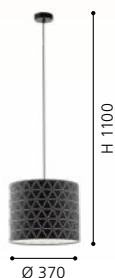

98352 RAMON

pendant light; steel, black / film, white
Hängeleuchte; Stahl, schwarz / Folie, weiss
luminaire en suspension; acier, noir / film, blanc

H 1100, Ø 160



E27 1x 40W



9 002759 983529



98353 RAMON

pendant light; steel, black / film, white
Hängeleuchte; Stahl, schwarz / Folie, weiss
luminaire en suspension; acier, noir / film, blanc

L 860, B 160, H 1100



E27 3x 40W



9 002759 983536

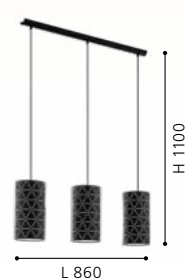



98456



98071

98456 CANTALLOPS

pendant light; steel, black
 Hängeleuchte; Stahl, schwarz
 luminaire en suspension; acier, noir

L 1150, B 520, H 1100



E14 6x 40W



9 002759 984564

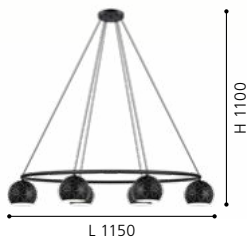

98071 CAMASTRA

pendant light; steel, black, gold
 Hängeleuchte; Stahl, schwarz, gold
 luminaire en suspension; acier, noir, or

H 1100, Ø 225



E27 1x 40W



9 002759 980719

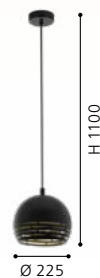



33345



97845



97841

33345 ROCCAFORTE

pendant light; steel, black, gold
Hängeleuchte; Stahl, schwarz, gold
luminaire en suspension; acier, noir, or

H 1100, Ø 170



E14 1x 40W



9 002759 333454

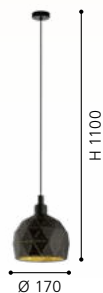

97845 ROCCAFORTE

pendant light; steel, black, gold
Hängeleuchte; Stahl, schwarz, gold
luminaire en suspension; acier, noir, or

H 1100, Ø 300



E27 1x 60W



9 002759 978457



97841 ROCCAFORTE

pendant light; steel, black, gold
Hängeleuchte; Stahl, schwarz, gold
luminaire en suspension; acier, noir, or

H 1100, Ø 400



E27 1x 60W



9 002759 978419





97846

97846 ROCCAFORTE

pendant light; steel, black, gold
Hängeleuchte; Stahl, schwarz, gold
luminaire en suspension; acier, noir, or

L 750, B 170, H 1100

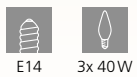

9 002759 978464

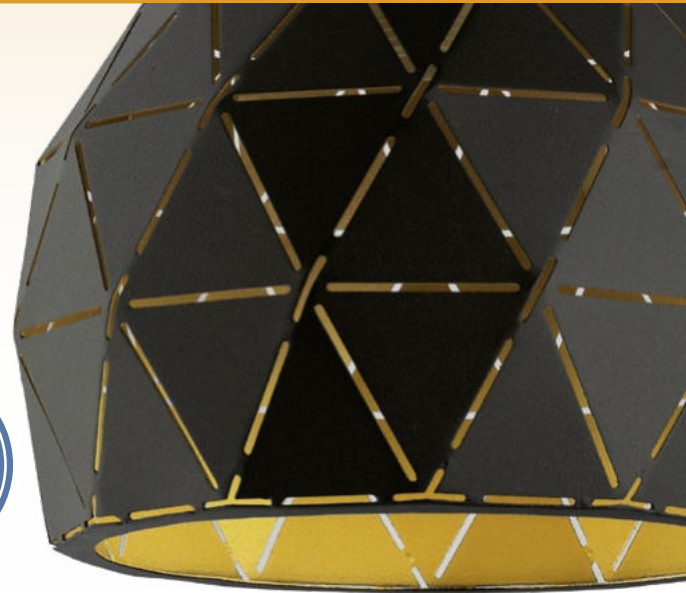
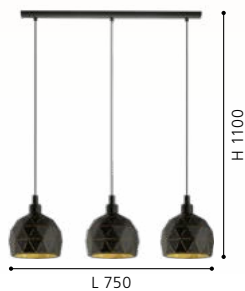



33344



97854

33344 ROCCAFORTE

pendant light; steel, white
Hängeleuchte; Stahl, weiss
luminaire en suspension; acier, blanc

H 1100, Ø 170



E14



1x 40W



9 002759 333447





97855

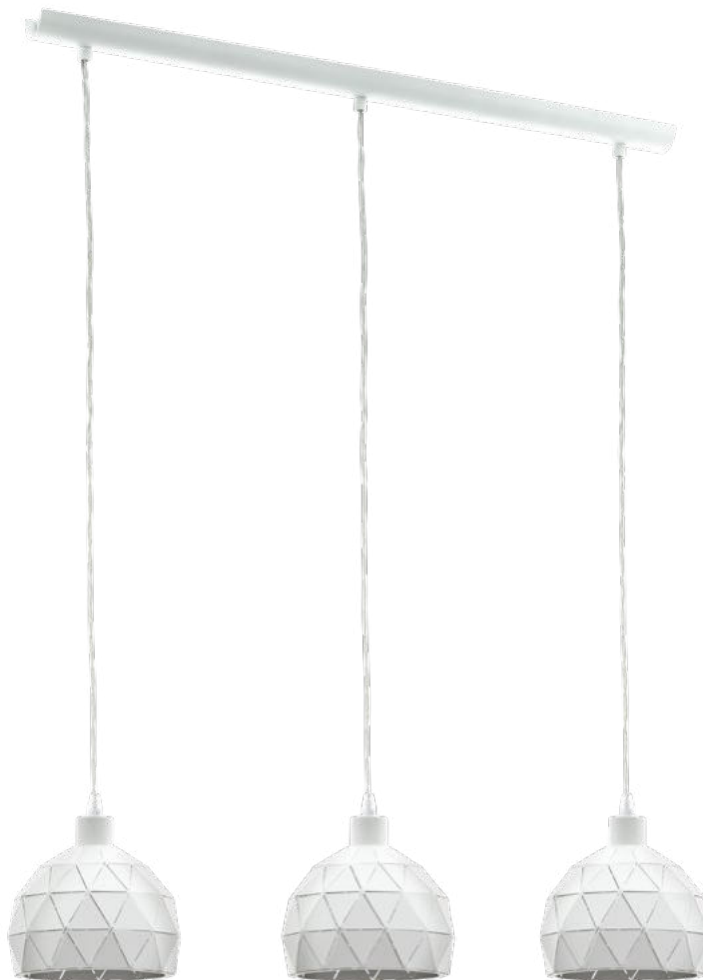

97857

97854 ROCCAFORTE

pendant light; steel, white
Hängeleuchte; Stahl, weiss
luminaire en suspension; acier, blanc

H 1100, Ø 300



E27 1x 60W



9 002759 978549



Ø 300

97855 ROCCAFORTE

pendant light; steel, white
Hängeleuchte; Stahl, weiss
luminaire en suspension; acier, blanc

H 1100, Ø 400



E27 1x 60W



9 002759 978556



Ø 400

97857 ROCCAFORTE

pendant light; steel, white
Hängeleuchte; Stahl, weiss
luminaire en suspension; acier, blanc

L 750, B 170, H 1100

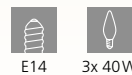

E14 3x 40W



9 002759 978570

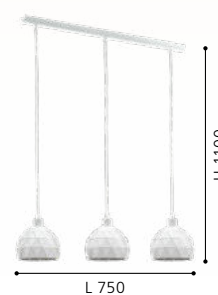

L 750



93373



93374



93373 CAMPILO

pendant light; plastic, white / paper threads, white
 Hängeleuchte; Kunststoff, weiss / Papierfäden, weiss
 luminaire en suspension; plastique, blanc / fils de papier, blanc

H 1100, Ø 450



9 002759 933739



93374 CAMPILO

pendant light; plastic, white / paper threads, beige
 Hängeleuchte; Kunststoff, weiss / Papierfäden, beige
 luminaire en suspension; plastique, blanc / fils de papier, beige

H 1100, Ø 450



9 002759 933746





95385



95383



95384

95385 OBREGON

pendant light; steel, brown, creme, oak
 Hängeleuchte; Stahl, braun, creme, eiche
 luminaire en suspension; acier, marron, crème, chêne

H 1100, Ø 350



E27 1x 60W



9 002759 953850

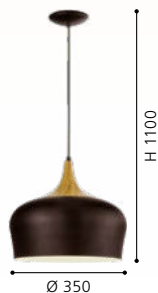

95383 OBREGON

pendant light; steel, creme, oak
 Hängeleuchte; Stahl, creme, eiche
 luminaire en suspension; acier, crème, chêne

H 1100, Ø 350



E27 1x 60W



9 002759 953836

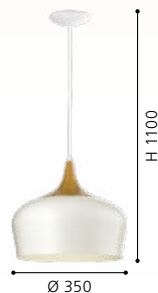

95384 OBREGON

pendant light; steel, white, chrome
 Hängeleuchte; Stahl, weiss, chrom
 luminaire en suspension; acier, blanc, chrome

H 1100, Ø 350



E27 1x 60W



9 002759 953843





96981

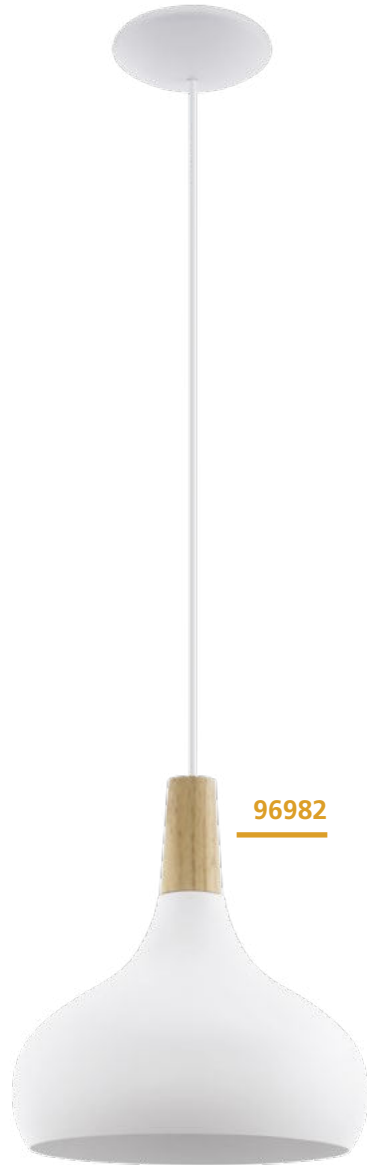

96982



96983

96981 SABINAR

pendant light; steel, white / wood, brown
Hängeleuchte; Stahl, weiss / Holz, braun
luminaire en suspension; acier, blanc / bois, marron

H 1100, Ø 180



9 002759 969813

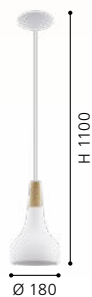

96982 SABINAR

pendant light; steel, white / wood, brown
Hängeleuchte; Stahl, weiss / Holz, braun
luminaire en suspension; acier, blanc / bois, marron

H 1100, Ø 280



9 002759 969820



96983 SABINAR

pendant light; steel, white / wood, brown
Hängeleuchte; Stahl, weiss / Holz, braun
luminaire en suspension; acier, blanc / bois, marron

H 1100, Ø 400



9 002759 969837





96985



96986



96985 SABINAR

pendant light; steel, brushed silver / wood, brown
Hängeleuchte; Stahl, silber gebürstet / Holz, braun
luminaire en suspension; acier, argent brossé / bois, marron

H 1100, Ø 280



E27 1x 60W

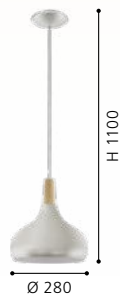

96986 SABINAR

pendant light; steel, brushed silver / wood, brown
Hängeleuchte; Stahl, silber gebürstet / Holz, braun
luminaire en suspension; acier, argent brossé / bois, marron

H 1100, Ø 400



E27 1x 60W



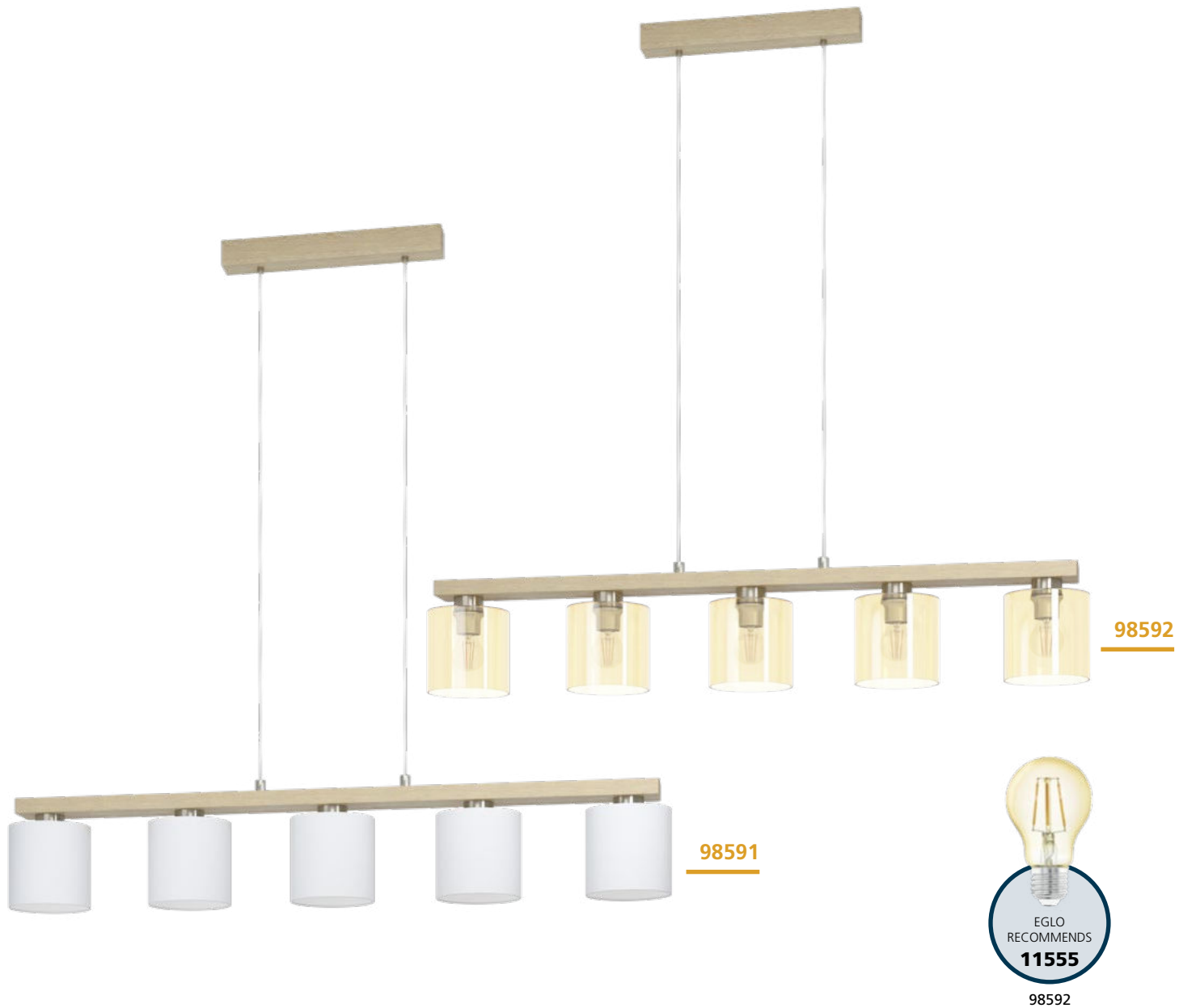

98591 CASTRALVO

pendant light; steel, wood, satin nickel, brown / fabric, white
 Hängeleuchte; Stahl, Holz, nickel-matt, braun / Textil, weiss
 luminaire en suspension; acier, bois, nickel mat, marron / tissu, blanc

L 1210, B 150, H 1100



E27 5x 28W



9 002759 985912

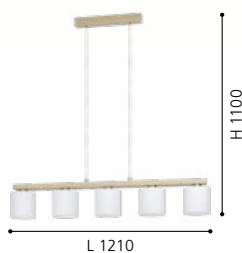

98592 CASTRALVO

pendant light; steel, wood, satin nickel, brown / glass vaporized, amber
 Hängeleuchte; Stahl, Holz, nickel-matt, braun / Glas bedampft, amber
 luminaire en suspension; acier, bois, nickel mat, marron / verre vaporisé, ambre

luminaire en suspension; acier, bois, nickel mat, marron / verre vaporisé, ambre

L 1210, B 150, H 1100



E27 5x 28W



9 002759 985929

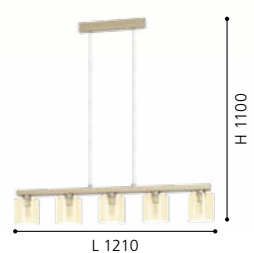



99701



99702

99701 VIGLIONI

pendant light; steel, wood, black, brown / glass vaporized, black-transparent

Hängeleuchte; Stahl, Holz, schwarz, braun / Glas bedampft, schwarz-transparent

luminaire en suspension; acier, bois, noir, marron / verre vaporisé, noir transparent

L 230, B 165, H 1100



E27



1x 40W



9 002759 997014

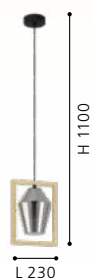

L 230

99702 VIGLIONI

pendant light; steel, wood, black, brown / glass vaporized, black-transparent

Hängeleuchte; Stahl, Holz, schwarz, braun / Glas bedampft, schwarz-transparent

luminaire en suspension; acier, bois, noir, marron / verre vaporisé, noir transparent

L 1060, B 165, H 1100



E27



3x 40W



9 002759 997021

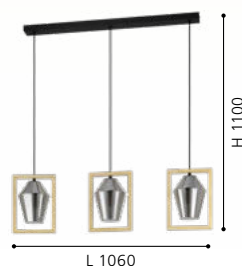

L 1060



95755



94935



94936

95755 NUVANO

pendant light; steel, brown, gold
Hängeleuchte; Stahl, braun, gold
luminaire en suspension; acier, marron, or

H 1100, Ø 480



E27



1x 60W



9 002759 957551



H 1100

Ø 480

94935 GAETANO 1

pendant light; steel, black, gold
Hängeleuchte; Stahl, schwarz, gold
luminaire en suspension; acier, noir, or

H 1500, Ø 380



E27



1x 60W



9 002759 949358



H 1500

Ø 380

94936 GAETANO 1

pendant light; steel, black, gold
Hängeleuchte; Stahl, schwarz, gold
luminaire en suspension; acier, noir, or

H 1500, Ø 530



E27



1x 60W



9 002759 949365



H 1500

Ø 530



99663

LED

99663 NUVANO

pendant light; steel, black, gold
 Hängeleuchte; Stahl, schwarz, gold
 luminaire en suspension; acier, noir, or

L 985, B 225, H 1100



GU10



3x 4,5W



3x

345 lm

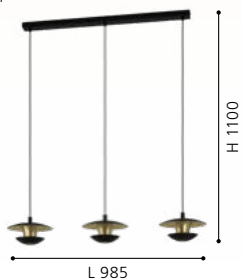

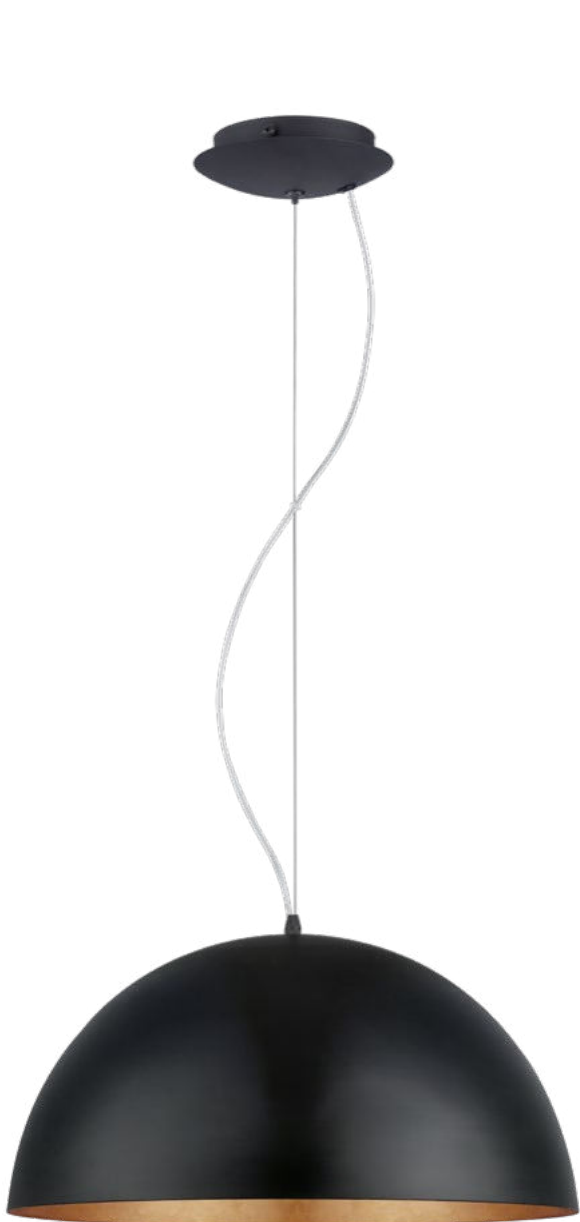

94938

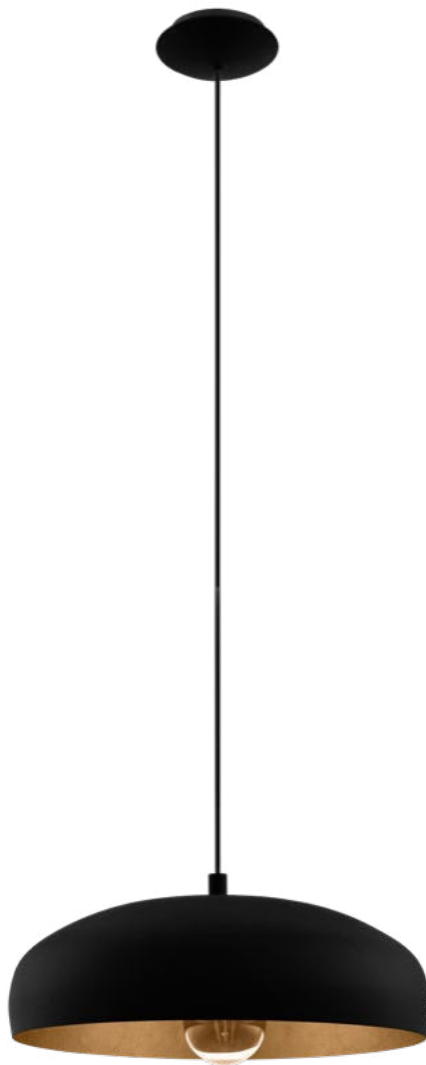

94605



94606

94938 GAETANO 1

pendant light; steel, black, copper
 Hängeleuchte; Stahl, schwarz, kupfer
 luminaire en suspension; acier, noir, cuivre

H 1500, Ø 530



9 002759 949389

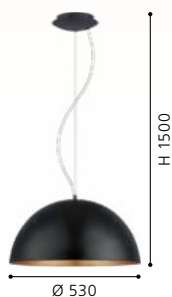

94605 MOGANO 1

pendant light; steel, black, copper
 Hängeleuchte; Stahl, schwarz, kupfer
 luminaire en suspension; acier, noir, cuivre

H 1100, Ø 400



9 002759 946050

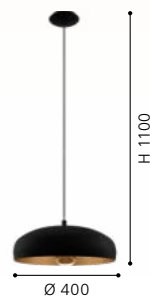

94606 MOGANO 1

pendant light; steel, white, copper
 Hängeleuchte; Stahl, weiss, kupfer
 luminaire en suspension; acier, blanc, cuivre

H 1100, Ø 400



9 002759 946067

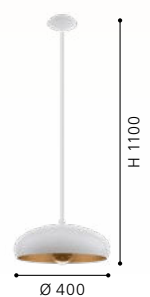



87055



31666

87055 BRENDA

pendant light; plastic, steel, white, chrome / steel, white
 Hängeleuchte; Kunststoff, Stahl, weiss, chrom / Stahl, weiss
 luminaire en suspension; plastique, acier, blanc, chrome / acier, blanc

H 1300, Ø 430



9 002759 870553

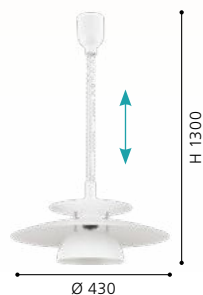

31666 BRENDA

pendant light; plastic, steel, black / steel, black, copper
 Hängeleuchte; Kunststoff, Stahl, schwarz / Stahl, schwarz, kupfer
 luminaire en suspension; plastique, acier, noir / acier, noir, cuivre

H 1100, Ø 430



9 002759 316662

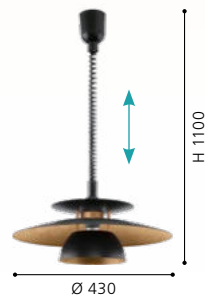

BRENDA

This luminaires are flexible in height thanks to the spiral cables.

Diese Leuchten sind durch die Spiralkabel in der Höhe verstellbar.

La hauteur de ces lumières peut être ajustée à l'aide du câble en spirale.





98735



99451

98734

98735 BRENDA

pendant light; steel, black, satin nickel
 Hängeleuchte; Stahl, schwarz, nickel-matt
 luminaire en suspension; acier, noir, nickel mat

H 1500, Ø 320

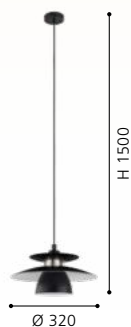

98734 BRENDA

pendant light; steel, white, satin nickel
 Hängeleuchte; Stahl, weiss, nickel-matt
 luminaire en suspension; acier, blanc, nickel mat

H 1500, Ø 320



99451 GAETANO 1

pendant light; steel, black, grey
 Hängeleuchte; Stahl, schwarz, grau
 luminaire en suspension; acier, noir, gris

H 1100, Ø 380

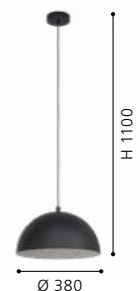

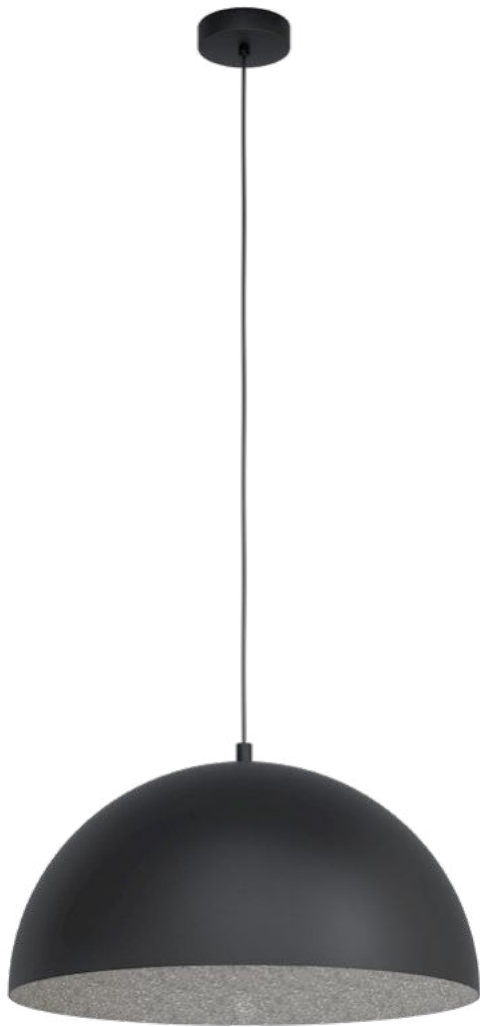

99452



94353



94354

99452 GAETANO 1

pendant light; steel, black, grey
Hängeleuchte; Stahl, schwarz, grau
luminaire en suspension; acier, noir, gris

H 1100, Ø 530



E27 1x 40W



9 002759 994525



94353 SARABIA

pendant light; steel, grey
Hängeleuchte; Stahl, grau
luminaire en suspension; acier, gris

H 1100, Ø 275



E27 1x 60W



9 002759 943530

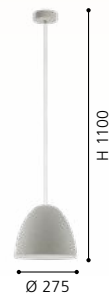

94354 SARABIA

pendant light; steel, grey
Hängeleuchte; Stahl, grau
luminaire en suspension; acier, gris

H 2000, Ø 405



E27 1x 60W



9 002759 943547





87054

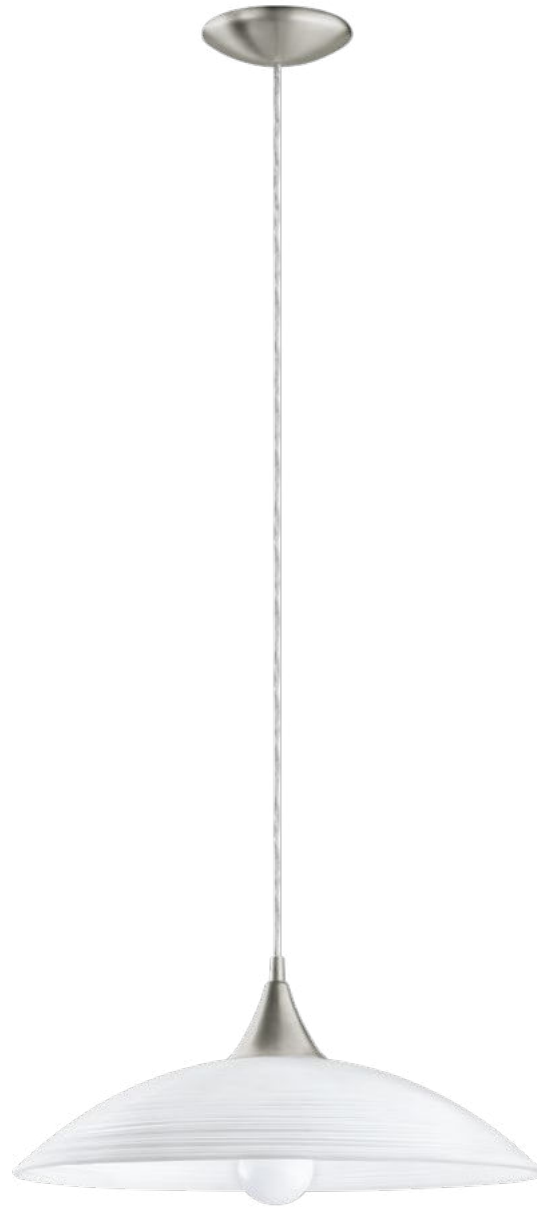

91496

87054 BRENDA

pendant light; steel, satin nickel / glass alabaster, white
 Hängeleuchte; Stahl, nickel-matt / Glas alabaster, weiss
 luminaire en suspension; acier, nickel mat / verre albâtre, blanc

H 1100, Ø 195



9 002759 870546



91496 LAZOLO

pendant light; steel, satin nickel / satin glass, white painted
 Hängeleuchte; Stahl, nickel-matt / Glas satiniert, weiss lackiert
 luminaire en suspension; acier, nickel mat / verre satiné, blanc laqué

H 1100, Ø 420



9 002759 914967

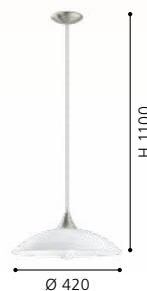

93468 MONTEFIO

pendant light; stainless steel, satin nickel / glass alabaster, white
 Hängeleuchte; Edelstahl, nickel-matt / Glas alabaster, weiss
 luminaire en suspension; acier inoxydable, nickel mat / verre albâtre, blanc

L 885, B 175, H 880 - 1300



9 002759 934682





93468

LED



87008



87009

87008 LORD 2

pendant light; plastic, steel, silver, satin nickel / glass alabaster, white

Hängeleuchte; Kunststoff, Stahl, silber, nickel-matt / Glas alabaster, weiss

luminaire en suspension; plastique, acier, argent, nickel mat / verre albâtre, blanc

H 1100, Ø 360



E27

1x 60W

87009 LORD 2

pendant light; plastic, wood, silver, satin nickel, beech / glass alabaster, white

Hängeleuchte; Kunststoff, Holz, silber, nickel-matt, Buche / Glas alabaster, weiss

luminaire en suspension; plastique, bois, argent, nickel mat, hêtre / verre albâtre, blanc

H 1100, Ø 360



E27

1x 60W

3355, 87008, 87009



These luminaires are flexible in height thanks to the spiral cables.

Diese Leuchten sind durch die Spiralkabel in der Höhe verstellbar.

La hauteur de ces lumières peut être ajustée à l'aide du câble en spirale.



9 002759 870089

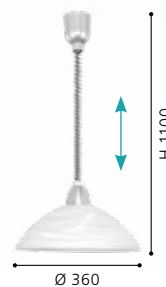

9 002759 870096

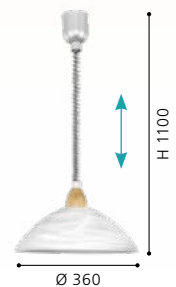



3355



90978



3355 ALESSANDRA

pendant light; plastic, white / glass alabaster, white
 Hängeleuchte; Kunststoff, weiss / Glas alabaster, weiss
 luminaire en suspension; plastique, blanc / verre albâtre, blanc

H 1100, Ø 380

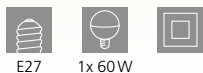

E27 1x 60W

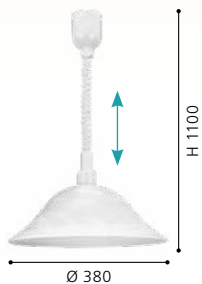

90978 ALBANY

pendant light; plastic, white / glass alabaster, white
 Hängeleuchte; Kunststoff, weiss / Glas alabaster, weiss
 luminaire en suspension; plastique, blanc / verre albâtre, blanc

H 1100, Ø 350

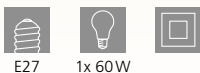

E27 1x 60W

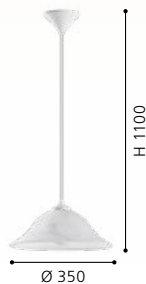

3355, 87008, 87009, 90978

These luminaires come with high quality processed alabaster glass.

Diese Leuchten sind mit hochwertigem Alabasterglas ausgestattet.

Ces luminaires viennent avec un abat-jour en verre d'albâtre haut de gamme.



3041 VETRO

pendant light; plastic, white / satin glass, white, purple, black
 Hängeleuchte; Kunststoff, weiss / Glas satiniert, weiss, lila, schwarz
 luminaire en suspension; plastique, blanc / verre satiné, blanc, violet, noir

H 1100, Ø 420

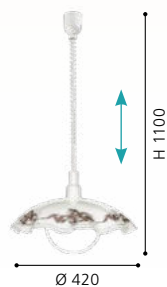

82786 VETRO

pendant light; plastic, white / glass, white, brown
 Hängeleuchte; Kunststoff, weiss / Glas, weiss, braun
 luminaire en suspension; plastique, blanc / verre, blanc, marron

H 1100, Ø 350

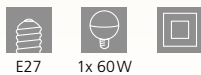

82785 VETRO

pendant light; plastic, white / satin glass, white
 Hängeleuchte; Kunststoff, weiss / Glas satiniert, weiss
 luminaire en suspension; plastique, blanc / verre satiné, blanc

H 1100, Ø 350

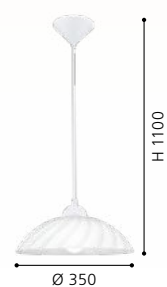



96474

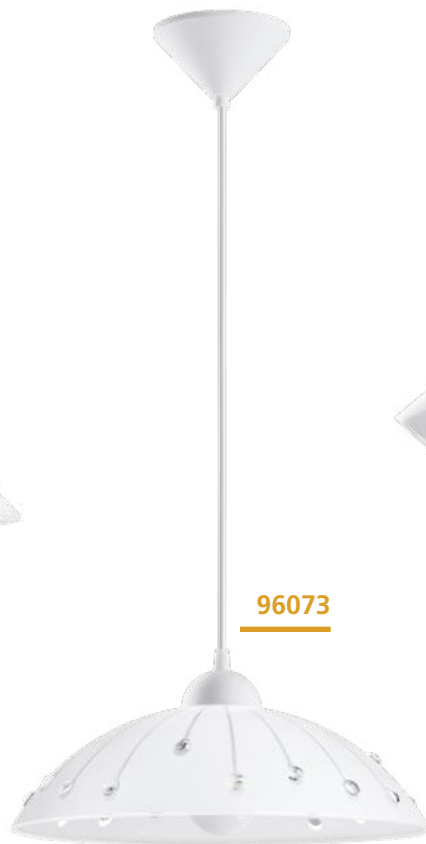

96073



96072

3041, 96072, 96474

These luminaires are flexible in height thanks to the spiral cables.

Diese Leuchten sind durch die Spiralkabel in der Höhe verstellbar.

La hauteur de ces lumières peut être ajustée à l'aide du câble en spirale.



96474 ALVEZ

pendant light; plastic, white / glass with structure, white, clear
Hängeleuchte; Kunststoff, weiss / Glas mit Struktur, weiss, klar
luminaire en suspension; plastique, blanc / verre avec structure, blanc, clair

H 1100, Ø 420

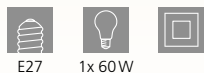

E27 1x 60W



9 002759 964740

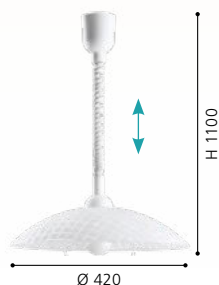

96073 VETRO

pendant light; plastic, white / satin glass, crystal, white, clear
Hängeleuchte; Kunststoff, weiss / Glas satiniert, Kristall, weiss, klar
luminaire en suspension; plastique, blanc / verre satiné, cristal, blanc, clair

H 1100, Ø 350

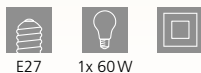

E27 1x 60W



9 002759 960735



96072 VETRO

pendant light; plastic, white / satin glass, crystal, white, clear
Hängeleuchte; Kunststoff, weiss / Glas satiniert, Kristall, weiss, klar
luminaire en suspension; plastique, blanc / verre satiné, cristal, blanc, clair

H 1100, Ø 415



E27 1x 60W



9 002759 960728

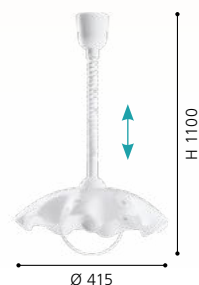

WALL & CEILING LUMINAIRES

WAND- & DECKENLEUCHTEN
APPLIQUES & PLAFONNIERS

OUR ALL-ROUNDERS -

The range of wall and ceiling luminaires goes from simple to unusual designs. No matter if for the entrance area, hallway or your living rooms – these luminaires give the right light.

UNSERE ALLROUNDER -

Das Sortiment an Wand- und Deckenleuchten reicht von schlichten bis hin zu ausgefallenen Designs. Egal ob für Eingangsbereich, Flur oder Ihre Wohnräume - diese Leuchten spenden das passende Licht.



NOS PASSE-PARTOUT -

La gamme d'éclairages muraux et de plafonds s'étend de designs simples à extraordinaires. Que ce soit pour l'entrée, le couloir ou vos espaces d'habitat - ces luminaires apportent la lumière appropriée.



Travel makes
you realize that
no matter how
much you know,
there's always



OVERVIEW

WALL & CEILING LUMINAIRES

							
ALTAFLOR p. 418-420	MONIROTE p. 419, 421	IPOSITTO p. 422	ROLIMARE p. 422	GROMOLA p. 422	AMONTILLADO p. 424	SPADAFORA p. 424	MARINELLO 1 p. 424
							
MARINELLO p. 425	MIRLAS p. 426	TAMURIA p. 428	MENDIETA p. 430	PASSA RELLA p. 430	TREMEDAL p. 431	MUSARA p. 431	LABARETU p. 431
							
BOCADELLA 1 p. 432	BELSIANA p. 434	ENCINITOS p. 435	BELSIANA 1 p. 435	STAITI p. 436-437	PASSANO 1 p. 436	MONTEBALDO p. 436	SILENTINA p. 438-439
							
MOGANO p. 440	VALCASOTTO p. 442, 498	BASURTU p. 443	MAROJALES p. 445	VERSUOLA p. 445	CONDRA 1 p. 446	CABO p. 448	MASIANO 1 p. 450-451
							
FRADELO 1 p. 452-453	FRADELO p. 454-456	ACOLLA 1 p. 458	ACOLLA p. 458	CARDITO p. 459	FUERTECUSA p. 459	PITALE p. 460	VALLEMARE p. 460
							
SORRENTA 1 p. 461	NERINI p. 461	CANICOSA 2 p. 462	MONTENOVO p. 463	POZONDON p. 463	PALOMARO p. 464-466	PALOMARO 1 p. 464-466	PASTORE p. 468
							
PASTORE 1 p. 468	PASTORE 2 p. 469	GIRON p. 470	GIRON-S p. 471	FRANIA p. 472-473, 476	FRANIA-S p. 474-475, 478-479	ZAMUDILO p. 480	SILERAS p. 480-481

 This product is available in different colors and shapes./ Dieser Artikel ist in unterschiedlichen Farben und Formen verfügbar.
Cet article est disponible en différentes couleurs et formes.

 RUIDERA p. 481	 VOLTAGO 2 p. 482-483	 LANCIANO 1 p. 484	 LANCIANO p. 484-485	 BENARIBA p. 486	 CAPASSO 1 p. 487	 COMPETA 2 p. 488	 COMPETA 1 p. 488-490
 COGOLETO p. 489	 PALERMO 2 p. 491	 CAPASSO p. 492	 NIEVES p. 492-493	 PESCAITO p. 494	 MUSURITA p. 494-495	 LAURITO p. 496	 SELUCI p. 496-497
 PENJAMO p. 499	 MENTALURGIA p. 500	 REDUCTA 2 p. 501	 LEGANES p. 501	 TORONJA p. 501	 ELLA p. 502	 DURELO p. 503	 PLANET p. 504
 LED PLANET p. 504	 PLANET 1 p. 506-509	 RICONTO 1 p. 510	 MARGITTA 1 p. 510-511	 VEREDA p. 511	 MARS p. 512-513, 518	 SCALEA 1 p. 512	 MARS 1 p. 512-514
 MAGITTA 1 p. 514	 RAYA p. 514	 GRAFIK p. 516	 NEMO p. 516	 SALOME p. 518-519	 MALVA p. 520	 MESTRE p. 520-521	 IMPERIAL p. 520
 ALMERA p. 521	 PASCAL 1 p. 521	 CAMPANIA p. 522	 GERBERA 1 p. 522	 COLTI p. 522	 TABILLANO 1 p. 524	 SAN PERI p. 524	 STAITI 1 p. 524
 GALDAKAO p. 526	 CIGLIE p. 527	 CARTIGNANO p. 528	 CIVITATE p. 529	 TAZZOLI p. 530	 GURARE p. 530	 ZINACUA p. 531	 ZUBIALDE p. 532

OVERVIEW

WALL & CEILING LUMINAIRES



BELATEGI
p. 533



ONO 2
p. 533



MACCACARI
p. 534



MACCACARI
p. 534



FELONICHE
p. 535



SANIA 4
p. 536 - 537



PASSA
p. 538 - 541



GASCUERIA
p. 542



ELIZONDO
p. 542



FALICETTO
p. 542



MONGODIO 1
p. 544



ELGVERO
p. 545



CADEGAL
p. 546 - 547



REMIDOS
p. 547



METRASS
p. 548



METRASS 2
p. 549



METRASS 1
p. 550 - 551



CUPELLA
p. 551



LASANA
p. 552



SARGINTO
p. 552 - 553



This product is available in different colors and shapes./ Dieser Artikel ist in unterschiedlichen Farben und Formen verfügbar.
Cet article est disponible en différentes couleurs et formes.



FUNCTIONAL OVERVIEW

FUNKTIONSÜBERSICHT

PRÉSENTATION FONCTIONNELLE

The listed boxes inform you about the respective functions of our wall and ceiling luminaires. You will find them on the catalogue pages next to the product illustrations. The coloured symbol area indicates the special characteristics of the respective luminaire/luminaire family, e.g. dimming function. In the grey area below you will find detailed information on this function, e.g. dimmable from 10 % - 100 %.

For luminaires that come with a remote control, you can control the respective functions with the remote control. For luminaires without remote control, the functions can be switched directly on the wall switch.

Die angeführten Boxen informieren Sie über die jeweiligen Funktionen unserer Wand- und Deckenleuchten. Sie finden sie auf den Katalogseiten jeweils neben den Produktabbildungen. Der farbige Symbolbereich weist darauf hin, welche besonderen Eigenschaften die jeweilige Leuchte/Leuchtenfamilie bietet, z.B. Dimmfunktion. Im grauen Bereich darunter finden Sie detaillierte Angaben zu dieser Funktion, z.B. dimmbar von 10 % - 100 %.

Ist eine Fernbedienung im Lieferumfang enthalten, können Sie die jeweiligen Funktionen mit der Fernbedienung steuern. Bei Leuchten ohne Fernbedienung können die Funktionen direkt am Wandschalter geschaltet werden.

Les boîtes de dialogue présentes vous informent sur les fonctions respectives de nos appliques et plafonniers. Vous les trouverez sur les pages du catalogue à côté des illustrations des produits. La zone colorée des symboles indique les caractéristiques particulières de chaque luminaire/famille de luminaires, par ex. la fonction de graduation. Dans la zone grise ci-dessous, vous trouverez des informations détaillées sur cette fonction, par ex. graduable de 10 % - 100 %.

Pour les luminaires équipés d'une télécommande, vous pouvez commander les fonctions correspondantes à l'aide de la télécommande. Pour les luminaires sans télécommande, les fonctions peuvent être commutées directement sur l'interrupteur mural.



DIMMABLE

e.g./z.B./par ex.
10 - 100 %

The brightness of the luminaire can be steplessly controlled.

Die Helligkeit der Leuchte kann stufenlos im angegebenen Bereich gesteuert werden.

La luminosité du luminaire peut être réglée en continu.



STEP DIMMING

e.g./z.B./par ex.
10 % / 50 % / 100 %

The brightness of the luminaire can be controlled step by step.

Die Helligkeit der Leuchte kann schrittweise gesteuert werden.

La luminosité du luminaire peut être réglée pas à pas.



TUNABLE WHITE

e.g./z.B./par ex.
2700 - 6500 K

The colour temperature can be controlled from warm to cold white LED light.

Die Farbtemperatur kann von warm- bis kaltweißem LED-Licht gesteuert werden.

La température de couleur peut être réglée de la lumière DEL blanche chaude à la lumière DEL blanche froide.



STEP TUNABLE

e.g./z.B./par ex.
3000 / 4000 / 5000 K

The colour temperature of warm to cold white LED light can be changed directly on the wall switch in 3 preset steps.

Die Farbtemperatur von warm- bis kaltweißem LED-Licht kann direkt am Wandschalter in 3 voreingestellten Schritten verändert werden.

La température de couleur peut être modifiée de la lumière DEL blanche chaude à la lumière DEL blanche froide directement sur l'interrupteur mural en 3 étapes prédéfinies.



NIGHT LIGHT FUNCTION

Luminaires can be switched to a night light mode. With included remote control or, for luminaires without remote control, via wall switch (ambient light).

Leuchten können auf einen Nacht-Licht-Modus umgeschaltet werden. Mit inkludierter Fernbedienung oder bei Leuchten ohne Fernbedienung per Wandschalter (Ambient light).

Les luminaires peuvent être commutés en mode veilleuse. Avec télécommande incluse ou, pour les luminaires sans télécommande, via interrupteur mural (lumière ambiante).



TIMER FUNCTION

e.g./z.B./par ex.
off after 30 sec.

The luminaire switches itself off after a preset time.

Die Leuchte schaltet sich nach einer voreingestellten Zeit selbst aus.

La lumière s'éteint d'elle-même après une durée prédéfinie.





99788

LED

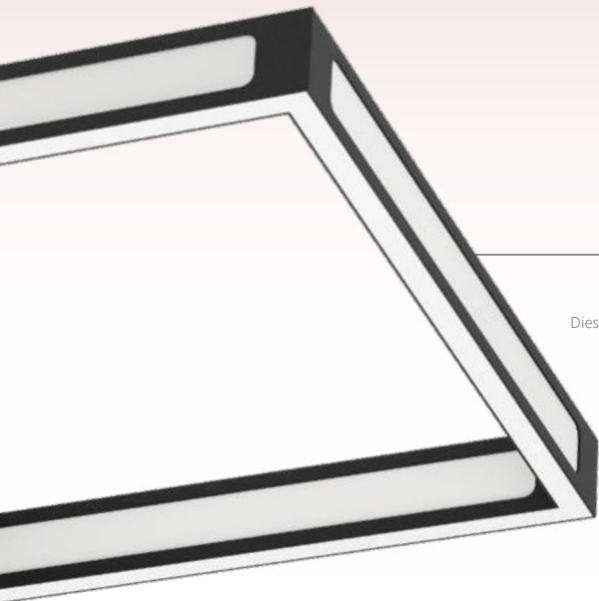

ALTAFLOR

These luminaires have an additional glow on the inside.

Diese Leuchten haben einen zusätzlichen Lichtschein nach Innen.

Ces luminaires ont une lueur supplémentaire à l'intérieur.

99788 ALTAFLOR

ceiling light; steel, black / plastic, white
Deckenleuchte; Stahl, schwarz / Kunststoff, weiss
plafonnier; acier, noir / plastique, blanc

L 640, B 295, H 70



24W



2400lm



9 002759 997885

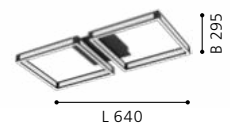

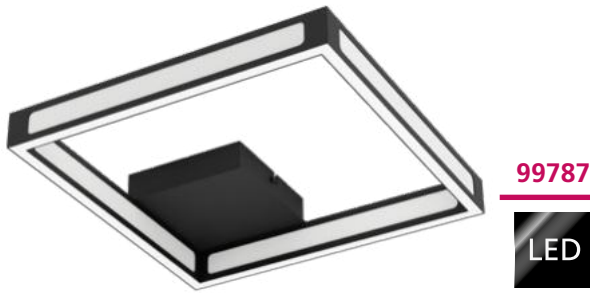

99787

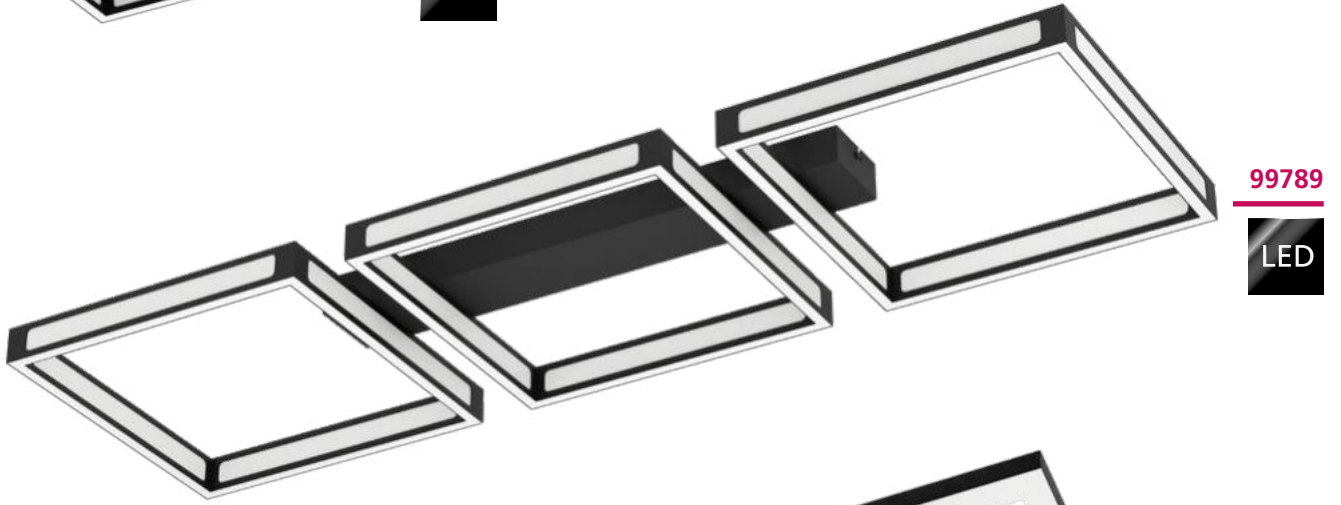

99789

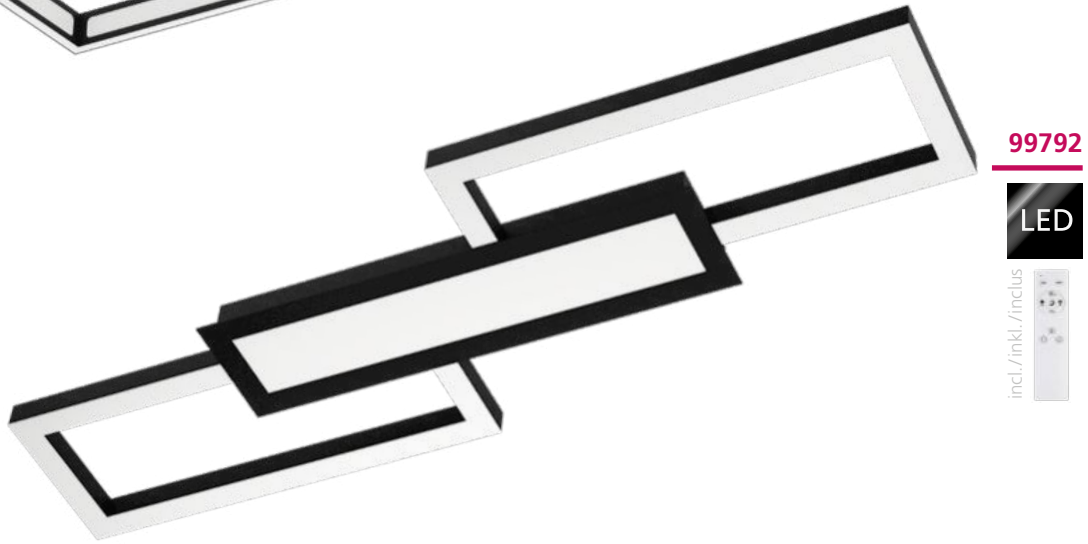

99792



incl./inkl./inclus

99787 ALTAFLOR

ceiling light; steel, black / plastic, white
Deckenleuchte; Stahl, schwarz / Kunststoff, weiss
plafonnier; acier, noir / plastique, blanc

L 310, B 310, H 70



12W 1200lm

99789 ALTAFLOR

ceiling light; steel, black / plastic, white
Deckenleuchte; Stahl, schwarz / Kunststoff, weiss
plafonnier; acier, noir / plastique, blanc

L 990, B 295, H 70



36W 3600lm

99792 MONIROTE

ceiling light; steel, aluminium, black / plastic, white
Deckenleuchte; Stahl, Alu, schwarz / Kunststoff, weiss
plafonnier; acier, aluminium, noir / plastique, blanc

L 780, H 45



37W 4450lm remote



9 002759 997878

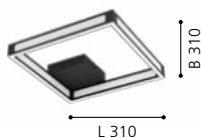

9 002759 997892

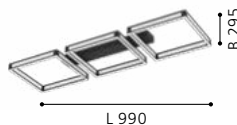

9 002759 997922

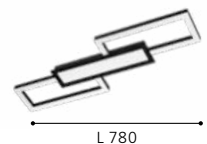



99784



99785

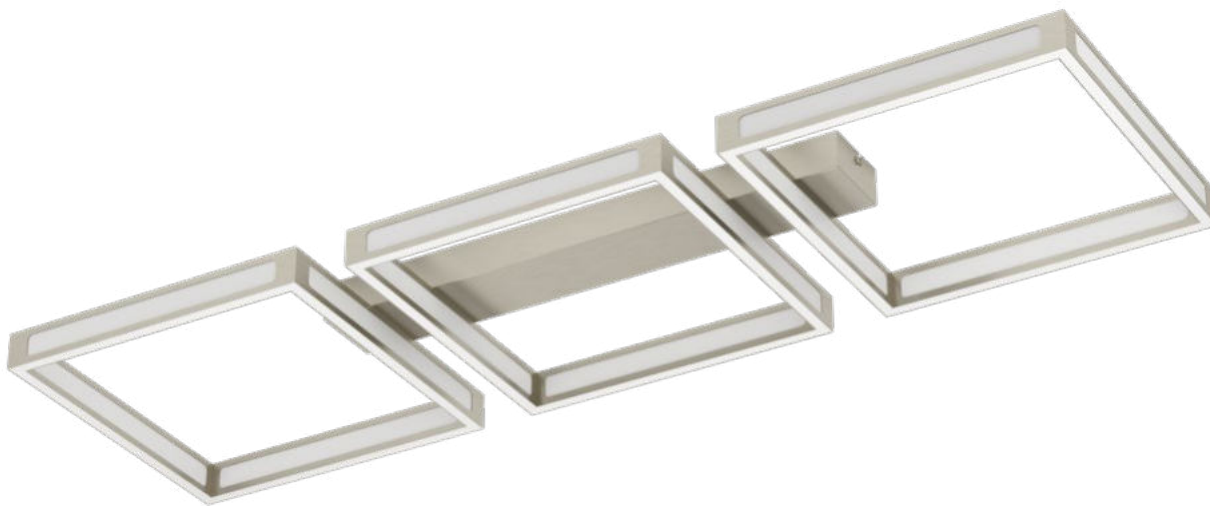

99786



99784 ALTAFLOR

ceiling light; steel, satin nickel / plastic, white
Deckenleuchte; Stahl, nickel-matt / Kunststoff, weiss
plafonnier; acier, nickel mat / plastique, blanc

L 310, B 310, H 70



12W



1200lm



99785 ALTAFLOR

ceiling light; steel, satin nickel / plastic, white
Deckenleuchte; Stahl, nickel-matt / Kunststoff, weiss
plafonnier; acier, nickel mat / plastique, blanc

L 640, B 295, H 70



24W



2400lm



99786 ALTAFLOR

ceiling light; steel, satin nickel / plastic, white
Deckenleuchte; Stahl, nickel-matt / Kunststoff, weiss
plafonnier; acier, nickel mat / plastique, blanc

L 990, B 295, H 70



36W



3600lm



9 002759 997847

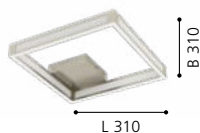

9 002759 997854

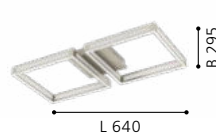

9 002759 997861

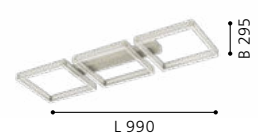



99791



incl./inkl./inclus



99791 MONIROTE

ceiling light; steel, aluminium, satin nickel / plastic, white
Deckenleuchte; Stahl, Alu, nickel-matt / Kunststoff, weiss
plafonnier; acier, aluminium, nickel mat / plastique, blanc

L 780, H 45



37W



4450lm



remote



9 002759 997915



L 780



99791

These luminaires have an additional glow on the inside.

Diese Leuchten haben einen zusätzlichen Lichtschein nach Innen.

Ces luminaires ont une lueur supplémentaire à l'intérieur.

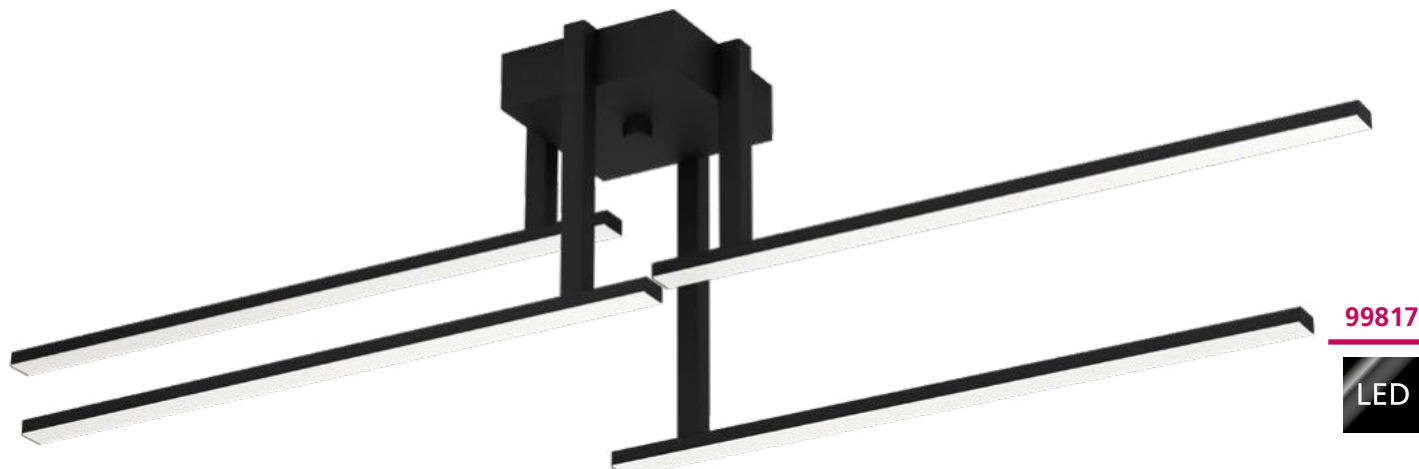

99817



99395



99817 IPOLITTO

ceiling light; aluminium, steel, black / plastic, white
Deckenleuchte; Alu, Stahl, schwarz / Kunststoff, weiss
plafonnier; aluminium, acier, noir / plastique, blanc

L 780, B 165, H 235



32W 3840lm



9 002759 998172

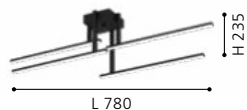

99395 ROLIMARE

ceiling light; aluminium, black / plastic, white
Deckenleuchte; Alu, schwarz / Kunststoff, weiss
plafonnier; aluminium, noir / plastique, blanc

L 420, B 400, H 130



35W 5500lm



9 002759 993955

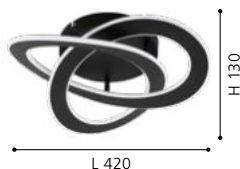

98539 GROMOLA

ceiling light; aluminium, steel, black, champagne
Deckenleuchte; Alu, Stahl, schwarz, champagner
plafonnier; aluminium, acier, noir, champagne

H 330, Ø 540



33,8W 4000lm



9 002759 985394





98539

LED



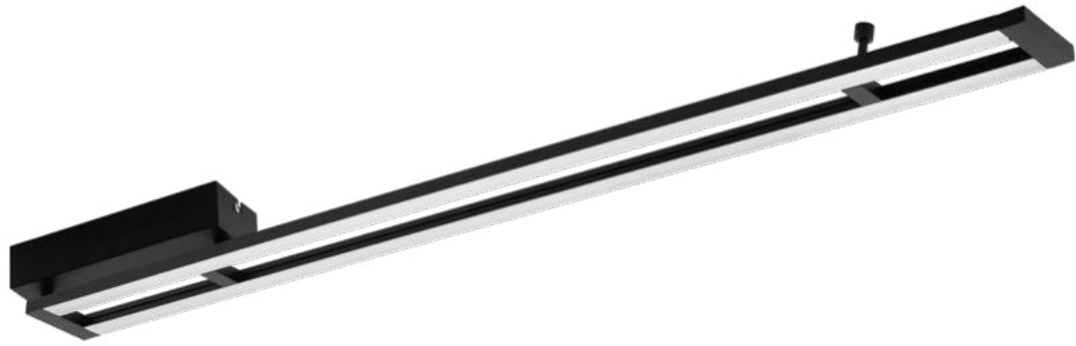

98491

LED



98494

LED

98491 AMONTILLADO

ceiling light; aluminium, steel, black / plastic, white
 Deckenleuchte; Alu, Stahl, schwarz / Kunststoff, weiss
 plafonnier; aluminium, acier, noir / plastique, blanc

L 1160, B 85



27W 3500lm

98494 SPADAFORA

ceiling light; aluminium, steel, black / plastic, clear, white
 Deckenleuchte; Alu, Stahl, schwarz / Kunststoff, klar, weiss
 plafonnier; aluminium, acier, noir / plastique, clair, blanc

L 1160, B 80, H 100



21W 2500lm

99793 MARINELLO 1

ceiling light; aluminium, steel, wood, black, brown / plastic, white
 Deckenleuchte; Alu, Stahl, Holz, schwarz, braun / Kunststoff, weiss
 plafonnier; aluminium, acier, bois, noir, marron / plastique, blanc

L 500, B 500, H 90



5x 5,25W 3700lm



9 002759 984915

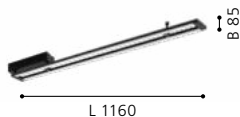

9 002759 984946



9 002759 997939

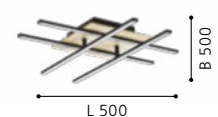

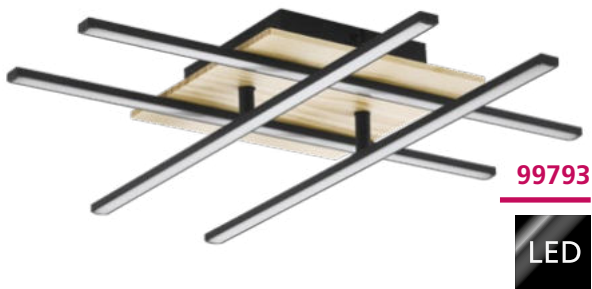

99793

LED



99659

LED

incl./inkl./inclus



99659 MARINELLO

ceiling light; aluminium, steel, wood, black, brown / plastic, white

Deckenleuchte; Alu, Stahl, Holz, schwarz, braun / Kunststoff, weiss

plafonnier; aluminium, acier, bois, noir, marron / plastique, blanc

L 485, B 485, H 55



2x 17W



2040lm



4,2W



510lm



remote



9 002759 996598

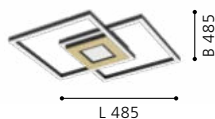



98861



98861 | 98862 | 98863



98862



98861 MIRLAS

ceiling light; wood, steel, brown / plastic, white
Deckenleuchte; Holz, Stahl, braun / Kunststoff, weiss
plafonnier; bois, acier, marron / plastique, blanc

L 360, B 210, H 90



E27



2x 9W

98862 MIRLAS

ceiling light; wood, steel, brown / plastic, white
Deckenleuchte; Holz, Stahl, braun / Kunststoff, weiss
plafonnier; bois, acier, marron / plastique, blanc

L 540, B 520, H 90



E27



4x 9W

98863 MIRLAS

ceiling light; wood, steel, brown / plastic, white
Deckenleuchte; Holz, Stahl, braun / Kunststoff, weiss
plafonnier; bois, acier, marron / plastique, blanc

L 540, B 520, H 90



E27



6x 9W



9 002759 988616

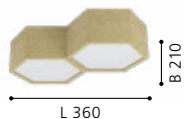

9 002759 988623

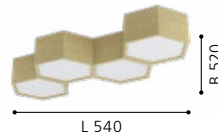

9 002759 988630

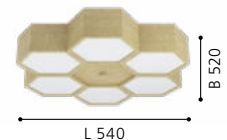



98863



99656

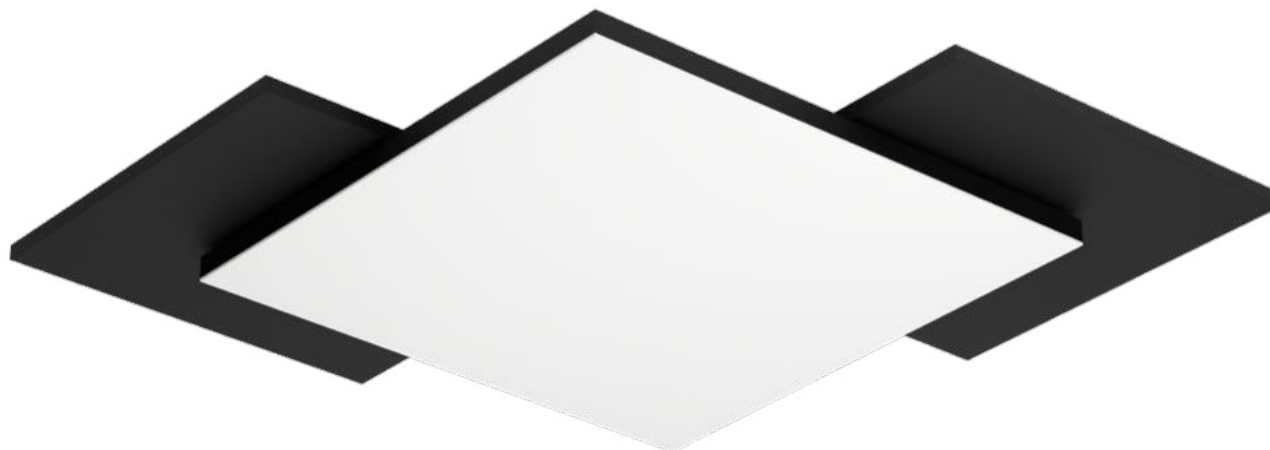

TAMURIA

This luminaires have rotatable panels in wood look and black.

Diese Artikel verfügen über Platten in Holzoptik und schwarz zum Wechseln.

Ces luminaires a des panneaux en bois optique et noir à changer.

99656 TAMURIA

ceiling light; steel, wood, black, brown / plastic, white
Deckenleuchte; Stahl, Holz, schwarz, braun / Kunststoff, weiss
plafonnier; acier, bois, noir, marron / plastique, blanc

L 435, B 435, H 70



24W 2800lm

99655 TAMURIA

ceiling light; steel, wood, black, brown / plastic, white
Deckenleuchte; Stahl, Holz, schwarz, braun / Kunststoff, weiss
plafonnier; acier, bois, noir, marron / plastique, blanc

L 285, B 285, H 60



12W 1100lm



9 002759 996567



9 002759 996550





99655

LED



98675



98756



98756

98675 MENDIETA

ceiling light; steel, black
Deckenleuchte; Stahl, schwarz
plafonnier; acier, noir

L 1160, B 120, H 270



98756 PASSA RELLA

ceiling light; steel, black
Deckenleuchte; Stahl, schwarz
plafonnier; acier, noir

L 1605, B 110, H 120



The angle of the tailpipes can be installed individually.

Der Winkel der Endrohre kann individuell montiert werden.

L'angle des sorties d'échappement peut être installé individuellement.



9 002759 986759

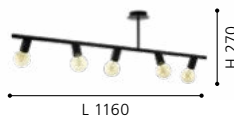

9 002759 987565

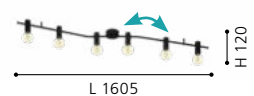



98507



98679



99014



98507 TREMEDAL

ceiling light; steel, black
Deckenleuchte; Stahl, schwarz
plafonnier; acier, noir

H 215, Ø 560



E27 1x 28W



9 002759 985073

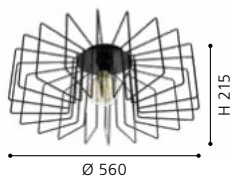

98679 MUSARA

ceiling light; steel, black
Deckenleuchte; Stahl, schwarz
plafonnier; acier, noir

H 850, Ø 790

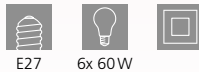

E27 6x 60W



9 002759 986797

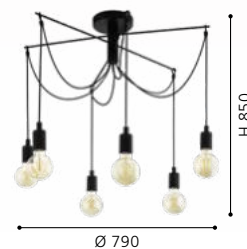

99014 LABARETU

ceiling light; steel, black
Deckenleuchte; Stahl, schwarz
plafonnier; acier, noir

L 780, B 60, H 300



E27 4x 60W



9 002759 990145





98317



98318

98317 BOCADELLA 1

ceiling light; steel, black
Deckenleuchte; Stahl, schwarz
plafonnier; acier, noir

H 215, Ø 345



E27



3x 60W



9 002759 983178

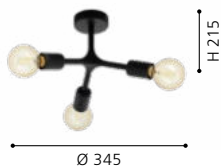

98318 BOCADELLA 1

ceiling light; steel, black
Deckenleuchte; Stahl, schwarz
plafonnier; acier, noir

H 365, Ø 640



E27



9x 60W



9 002759 983185

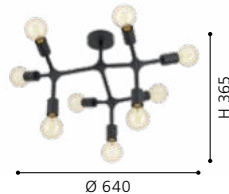

98319 BOCADELLA 1

ceiling light; steel, black
Deckenleuchte; Stahl, schwarz
plafonnier; acier, noir

H 360, Ø 920



E27



12x 60W



9 002759 983192

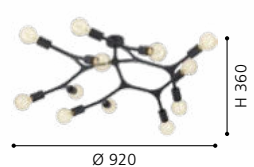



98319



98034



98035

98034 BELSIANA

ceiling light; steel, black
Deckenleuchte; Stahl, schwarz
plafonnier; acier, noir

L 890, B 510, H 350



9 002759 980344

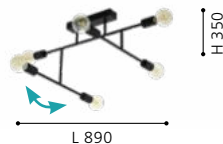

98035 BELSIANA

ceiling light; steel, black
Deckenleuchte; Stahl, schwarz
plafonnier; acier, noir

L 1180, B 510, H 350



9 002759 980351

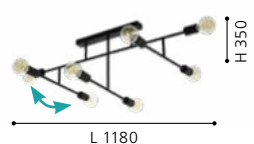



99664

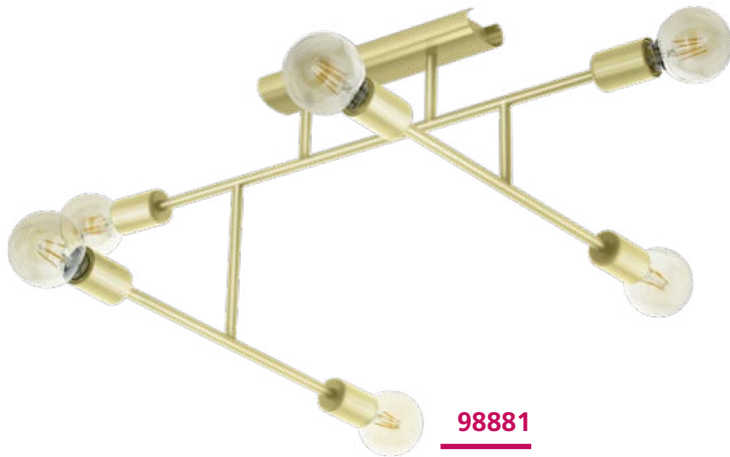

98881



98882

99664 ENCINITOS

ceiling light; steel, black, gold
Deckenleuchte; Stahl, schwarz, gold
plafonnier; acier, noir, or

H 260, Ø 450



E27 1x 40W



9 002759 996642

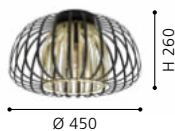

98881 BELSIANA 1

ceiling light; steel, brushed brass
Deckenleuchte; Stahl, messing-gebürstet
plafonnier; acier, laiton brossé

L 1155, B 495, H 455



E27 6x 40W



9 002759 988814

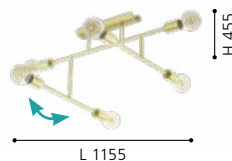

98882 BELSIANA 1

ceiling light; steel, brushed brass
Deckenleuchte; Stahl, messing-gebürstet
plafonnier; acier, laiton brossé

L 1180, B 380, H 350



E27 8x 40W



9 002759 988821

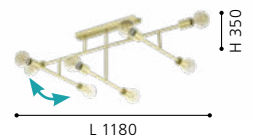



98156

97904



97731

LED

97904 STAITI

ceiling light; steel, black
Deckenleuchte; Stahl, schwarz
plafonnier; acier, noir

H 140, Ø 760



E27

7x 60W

98156 PASSANO 1

ceiling light; steel, black
Deckenleuchte; Stahl, schwarz
plafonnier; acier, noir

H 95, Ø 450



E27

3x 60W

97731 MONTEBALDO

ceiling light; steel, black, gold
Deckenleuchte; Stahl, schwarz, gold
plafonnier; acier, noir, or

L 380, B 380, H 170



GU10

4x 4,5W

4x

345lm



9 002759 979041



H 140

Ø 760



9 002759 981563



H 95

Ø 450



9 002759 977313

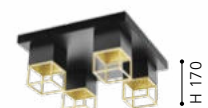

H 170

L 380



97903



97895



97903 STAITI

ceiling light; steel, white / fabric, white
Deckenleuchte; Stahl, weiss / Textil, weiss
plafonnier; acier, blanc / tissu, blanc

H 235, Ø 840



9 002759 979034

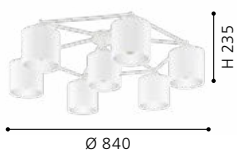

97895 STAITI

ceiling light; steel, black / fabric, black, gold
Deckenleuchte; Stahl, schwarz / Textil, schwarz, gold
plafonnier; acier, noir / tissu, noir, or

H 235, Ø 840



9 002759 978952

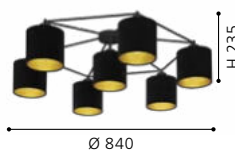



98331



98332



98334

98331 SILENTINA

ceiling light; steel, black
Deckenleuchte; Stahl, schwarz
plafonnier; acier, noir

L 180, B 180, H 205



E27

1x 40W

98332 SILENTINA

ceiling light; steel, black
Deckenleuchte; Stahl, schwarz
plafonnier; acier, noir

L 360, B 180, H 205



E27

2x 40W

98334 SILENTINA

ceiling light; steel, black
Deckenleuchte; Stahl, schwarz
plafonnier; acier, noir

L 360, B 360, H 205



E27

4x 40W



9 002759 983314

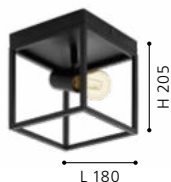

9 002759 983321

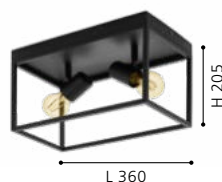

9 002759 983345

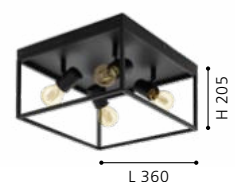



98333

98333 SILENTINA

ceiling light; steel, black
Deckenleuchte; Stahl, schwarz
plafonnier; acier, noir

L 540, B 180, H 205



E27



3x 40W



9 002759 983338

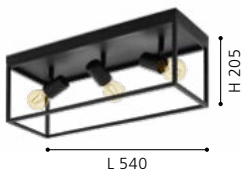



94547



94548

94547 MOGANO

ceiling light; steel, black, copper
Deckenleuchte; Stahl, schwarz, kupfer
plafonnier; acier, noir, cuivre

H 170, Ø 400



E27 1x 60W



9 002759 945473

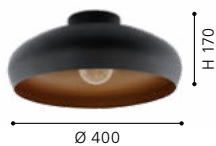

94548 MOGANO

ceiling light; steel, white, silver
Deckenleuchte; Stahl, weiss, silber
plafonnier; acier, blanc, argent

H 170, Ø 400



E27 1x 60W



9 002759 945480



43637 MOGANO

ceiling light; steel, black
Deckenleuchte; Stahl, schwarz
plafonnier; acier, noir

H 170, Ø 400



E27 1x 60W



9 002759 436377

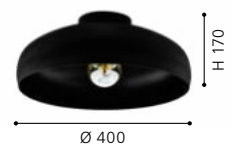



43637





99515



99514



99516



99514 VALCASOTTO

ceiling light; steel, black
Deckenleuchte; Stahl, schwarz
plafonnier; acier, noir

L 110, B 110, H 100

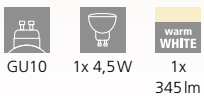

GU10 1x 4,5W 1x
345lm

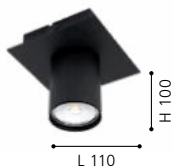

99515 VALCASOTTO

ceiling light; steel, black
Deckenleuchte; Stahl, schwarz
plafonnier; acier, noir

L 570, B 100, H 100

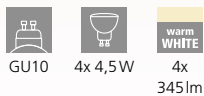

GU10 4x 4,5W 4x
345lm



99516 VALCASOTTO

ceiling light; steel, black
Deckenleuchte; Stahl, schwarz
plafonnier; acier, noir

L 320, B 320, H 100

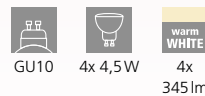

GU10 4x 4,5W 4x
345lm





99667

99667 BASURTU

ceiling light; steel, black
Deckenleuchte; Stahl, schwarz
plafonnier; acier, noir

H 270, Ø 1050



E27



5x 40W



9 002759 996673

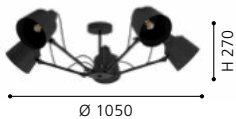



98515



98514

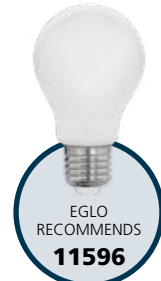

99021



98514 | 98515



99021

98515 MAROJALES

ceiling light; steel, black / glass vaporized, black-transparent
 Deckenleuchte; Stahl, schwarz / Glas bedampft, schwarz-transparent
 plafonnier; acier, noir / verre vaporisé, noir transparent

L 1215, B 180, H 280



E27 4x 28W



9 002759 985158



L 1215

98514 MAROJALES

ceiling light; steel, black / glass vaporized, black-transparent
 Deckenleuchte; Stahl, schwarz / Glas bedampft, schwarz-transparent
 plafonnier; acier, noir / verre vaporisé, noir transparent

L 555, B 180, H 280



E27 2x 28W



9 002759 985141



L 555

99021 VERSUOLA

ceiling light; steel, black / glass opal-matt, white
 Deckenleuchte; Stahl, schwarz / Glas opal-matt, weiss
 plafonnier; acier, noir / verre opale mat, blanc

L 770, B 200, H 325



E27 3x 40W



9 002759 990213



L 770

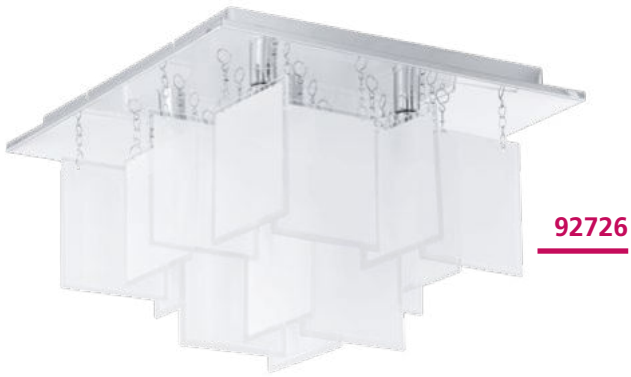

92726



92813

92726 CONDRA 1

ceiling light; steel, chrome / satin glass, white
Deckenleuchte; Stahl, chrom / Glas satiniert, weiss
plafonnier; acier, chrome / verre satiné, blanc

L 370, B 370, H 235



G9

5x 33W

92813 CONDRA 1

ceiling light; steel, chrome / satin glass, white, clear
Deckenleuchte; Stahl, chrom / Glas satiniert, weiss, klar
plafonnier; acier, chrome / verre satiné, blanc, clair

L 770, B 770, H 485



G9

16x 18W

92727 CONDRA 1

ceiling light; steel, chrome / satin glass, white
Deckenleuchte; Stahl, chrom / Glas satiniert, weiss
plafonnier; acier, chrome / verre satiné, blanc

L 470, B 470, H 300



G9

8x 18W



9 002759 927264

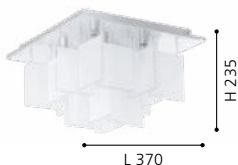

9 002759 928131

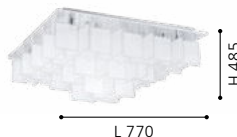

9 002759 927271

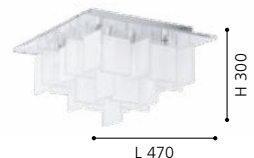



92727



30932

LED



30933

LED

30933 CABO

ceiling light; stainless steel, chrome / satin glass, white, clear
Deckenleuchte; Edelstahl, chrom / Glas satiniert, weiss, klar
plafonnier; acier inoxydable, chrome / verre satiné, blanc, clair

H 70, Ø 350

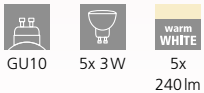

30932 CABO

ceiling light; stainless steel, chrome / satin glass, white, clear
Deckenleuchte; Edelstahl, chrom / Glas satiniert, weiss, klar
plafonnier; acier inoxydable, chrome / verre satiné, blanc, clair

L 340, B 340, H 70

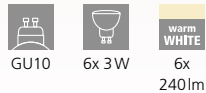

30931 CABO

ceiling light; stainless steel, chrome / satin glass, white, clear
Deckenleuchte; Edelstahl, chrom / Glas satiniert, weiss, klar
plafonnier; acier inoxydable, chrome / verre satiné, blanc, clair

L 290, B 290, H 70

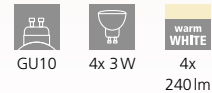



30931

LED





99361



99362



99363



99361 MASIANO 1

wall / ceiling light; aluminium, steel, black / plastic, satined
Wand- / Deckenleuchte; Alu, Stahl, schwarz / Kunststoff, satiniert

applique / plafonnier; aluminium, acier, noir / plastique, satiné

L 120, B 120, H 55



1x 3,3W
1x 340lm

99362 MASIANO 1

wall / ceiling light; aluminium, steel, black / plastic, satined
Wand- / Deckenleuchte; Alu, Stahl, schwarz / Kunststoff, satiniert

applique / plafonnier; aluminium, acier, noir / plastique, satiné

L 250, B 120, H 50



2x 3,3W
2x 340lm

99363 MASIANO 1

wall / ceiling light; aluminium, steel, black / plastic, satined
Wand- / Deckenleuchte; Alu, Stahl, schwarz / Kunststoff, satiniert

applique / plafonnier; aluminium, acier, noir / plastique, satiné

L 440, B 120, H 50



3x 3,3W
3x 340lm



9 002759 993610

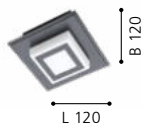

9 002759 993627

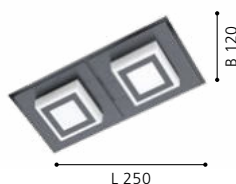

9 002759 993634

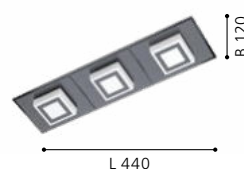



99364



99364 MASIANO 1

wall / ceiling light; aluminium, steel, black / plastic, satiné

Wand- / Deckenleuchte; Alu, Stahl, schwarz / Kunststoff, satiniert

applique / plafonnier; aluminium, acier, noir / plastique, satiné

L 250, B 250, H 55



4x 3,3W

4x
340lm

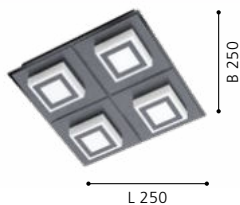



99324

LED



99325

LED



99328

LED

99324 FRADELO 1

wall / ceiling light; steel, black / plastic, crystal, black, clear
Wand- / Deckenleuchte; Stahl, schwarz / Kunststoff, Kristall, schwarz, klar
applique / plafonnier; acier, noir / plastique, cristal, noir, clair

L 140, B 140, H 60



1x 4W
1x
400lm

99325 FRADELO 1

wall / ceiling light; steel, black / plastic, crystal, black, clear
Wand- / Deckenleuchte; Stahl, schwarz / Kunststoff, Kristall, schwarz, klar
applique / plafonnier; acier, noir / plastique, cristal, noir, clair

L 460, B 140, H 60



3x 4W
3x
400lm

99328 FRADELO 1

ceiling light; steel, black / plastic, crystal, black, clear
Deckenleuchte; Stahl, schwarz / Kunststoff, Kristall, schwarz, klar
plafonnier; acier, noir / plastique, cristal, noir, clair

L 520, B 520, H 95



12W
1250lm



9 002759 993245

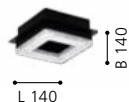

9 002759 993252

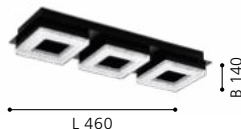

9 002759 993283

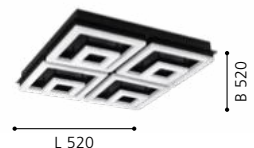



99327

LED



99326

LED

99327 FRADELO 1

ceiling light; steel, black / plastic, crystal, black, clear
 Deckenleuchte; Stahl, schwarz / Kunststoff, Kristall, schwarz, klar
 plafonnier; acier, noir / plastique, cristal, noir, clair

L 260, B 260, H 85



12W 1250lm

99326 FRADELO 1

wall / ceiling light; steel, black / plastic, crystal, black, clear
 Wand- / Deckenleuchte; Stahl, schwarz / Kunststoff, Kristall, schwarz, klar
 applique / plafonnier; acier, noir / plastique, cristal, noir, clair

L 280, B 280, H 60



4x 4W 4x 400lm



9 002759 993276

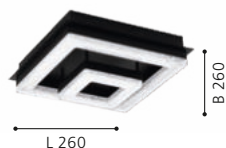

9 002759 993269

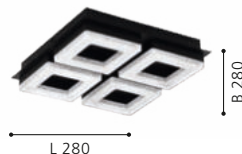

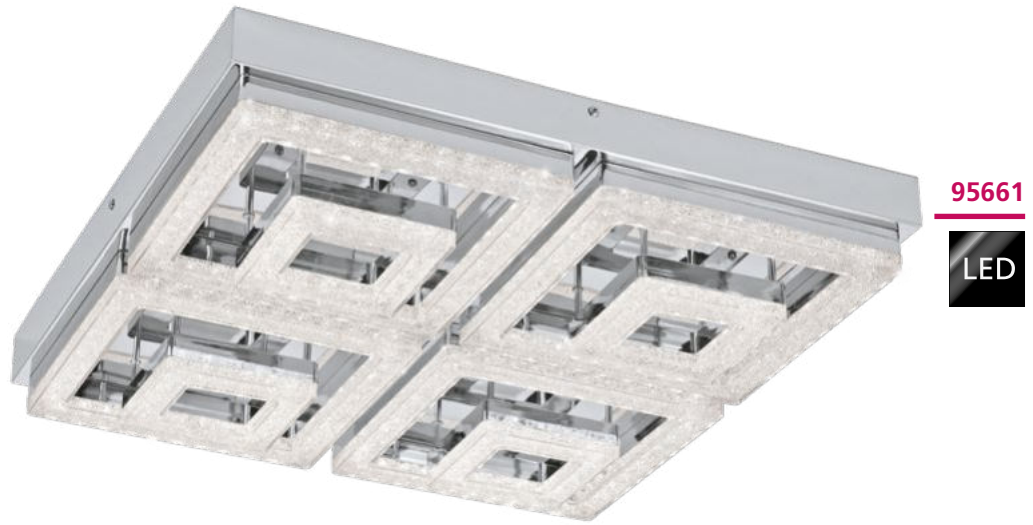

95655 FRADELO

wall / ceiling light; steel, chrome / plastic, crystal, chrome, clear
 Wand- / Deckenleuchte; Stahl, chrom / Kunststoff, Kristall, chrom, klar
 applique / plafonnier; acier, chrome / plastique, cristal, chrome, clair

L 140, B 140, H 60



1x 4W 400lm

95656 FRADELO

wall / ceiling light; steel, chrome / plastic, crystal, chrome, clear
 Wand- / Deckenleuchte; Stahl, chrom / Kunststoff, Kristall, chrom, klar
 applique / plafonnier; acier, chrome / plastique, cristal, chrome, clair

L 460, B 140, H 60



3x 4W 1200lm

95661 FRADELO

ceiling light; steel, chrome / plastic, crystal, chrome, clear
 Deckenleuchte; Stahl, chrom / Kunststoff, Kristall, chrom, klar
 plafonnier; acier, chrome / plastique, cristal, chrome, clair

L 520, B 520, H 95



48W 5000lm



9 002759 956554

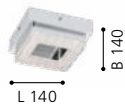

9 002759 956561



9 002759 956615

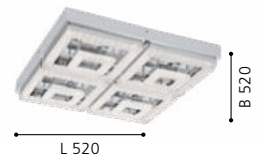



95657

LED



95659

LED



95658

LED



95657 FRADELO

wall / ceiling light; steel, chrome / plastic, crystal, chrome, clear
Wand- / Deckenleuchte; Stahl, chrom / Kunststoff, Kristall, chrom, klar
applique / plafonnier; acier, chrome / plastique, cristal, chrome, clair

L 280, B 280, H 60



4x 4W 1600lm

95659 FRADELO

ceiling light; steel, chrome / plastic, crystal, chrome, clear
Deckenleuchte; Stahl, chrom / Kunststoff, Kristall, chrom, klar
plafonnier; acier, chrome / plastique, cristal, chrome, clair

L 260, B 260, H 85



12W 1250lm

95658 FRADELO

wall / ceiling light; steel, chrome / plastic, crystal, chrome, clear
Wand- / Deckenleuchte; Stahl, chrom / Kunststoff, Kristall, chrom, klar
applique / plafonnier; acier, chrome / plastique, cristal, chrome, clair

L 440, B 440, H 70



9x 4W 3600lm



9 002759 956578



9 002759 956592

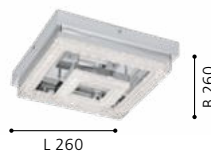

9 002759 956585





95662



95663



95662 FRADELO

wall / ceiling light; steel, chrome / plastic, crystal, chrome, clear
Wand- / Deckenleuchte; Stahl, chrom / Kunststoff, Kristall, chrom, klar
applique / plafonnier; acier, chrome / plastique, cristal, chrome, clair

L 140, B 140, H 60



1x 4W 400lm

95663 FRADELO

wall / ceiling light; steel, chrome / plastic, crystal, chrome, clear
Wand- / Deckenleuchte; Stahl, chrom / Kunststoff, Kristall, chrom, klar
applique / plafonnier; acier, chrome / plastique, cristal, chrome, clair

L 460, B 140, H 60



3x 4W 1200lm

95664 FRADELO

wall / ceiling light; steel, chrome / plastic, crystal, chrome, clear
Wand- / Deckenleuchte; Stahl, chrom / Kunststoff, Kristall, chrom, klar
applique / plafonnier; acier, chrome / plastique, cristal, chrome, clair

L 280, B 280, H 60



4x 4W 1600lm



9 002759 956622



9 002759 956639



9 002759 956646





95664

LED





99357

LED

99356

LED

95639

LED

99357 ACOLLA 1

wall / ceiling light; steel, black / glass with crystals, white, clear
 Wand- / Deckenleuchte; Stahl, schwarz / Glas mit Kristallen, weiss, klar
 applique / plafonnier; acier, noir / verre avec cristaux, blanc, clair

H 90, Ø 370

LED

warm
WHITE
16W 1500lm



99356 ACOLLA 1

wall / ceiling light; steel, black / glass with crystals, white, clear
 Wand- / Deckenleuchte; Stahl, schwarz / Glas mit Kristallen, weiss, klar
 applique / plafonnier; acier, noir / verre avec cristaux, blanc, clair

H 85, Ø 290

LED

warm
WHITE
11W 950lm



95639 ACOLLA

wall / ceiling light; steel, chrome / glass with crystals, white, clear
 Wand- / Deckenleuchte; Stahl, chrom / Glas mit Kristallen, weiss, klar
 applique / plafonnier; acier, chrome / verre avec cristaux, blanc, clair

H 85, Ø 290

LED

warm
WHITE
11W 950lm



9 002759 993573



Ø 370



9 002759 993566



Ø 290



9 002759 956394



Ø 290



32025

LED



32026

LED



98597

LED

32025 CARDITO

ceiling light; steel, chrome / glass, crystal, clear
Deckenleuchte; Stahl, chrom / Glas, Kristall, klar
plafonnier; acier, chrome / verre, cristal, clair

L 320, B 320, H 55



16W 1700lm

32026 CARDITO

ceiling light; steel, chrome / glass, crystal, clear
Deckenleuchte; Stahl, chrom / Glas, Kristall, klar
plafonnier; acier, chrome / verre, cristal, clair

L 440, B 440, H 55



4x 6,7W 3400lm

98597 FUERTESCUSA

wall light; steel, chrome / crystal, clear
Wandleuchte; Stahl, chrom / Kristall, klar
applique; acier, chrome / cristal, clair

L 130, H 130, A 110

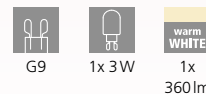

G9 1x 3W 1x 360lm



9 002759 320256

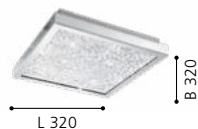

9 002759 320263

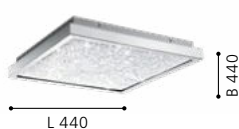

9 002759 985974

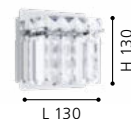



95162

LED



PITALE, VALLEMARE

These luminaires come with high quality glass crystals.

Diese Leuchten sind mit hochwertigen Glaskristallen ausgestattet.

Ces luminaires viennent avec des cristaux de verre de haute qualité.

95162 PITALE

ceiling light; steel, chrome / satin glass, white
Deckenleuchte; Stahl, chrom / Glas satiniert, weiss
plafonnier; acier, chrome / verre satiné, blanc

H 100, Ø 630



G9



6x 3W



6x
warm
WHITE
360lm



9 002759 951627



Ø 630

97487 VALLEMARE

wall / ceiling light; aluminium, steel, chrome / plastic, crystal, white, clear

Wand- / Deckenleuchte; Alu, Stahl, chrom / Kunststoff, Kristall, weiss, klar

applique / plafonnier; aluminium, acier, chrome / plastique, cristal, blanc, clair

H 125, Ø 650



5x 6,6W



5x
warm
WHITE
800lm



9 002759 974879



Ø 650



95689



95576



97487



95689 SORRENTA 1

wall / ceiling light; steel, white / glass with crystals, white, clear
Wand- / Deckenleuchte; Stahl, weiss / Glas mit Kristallen, weiss, klar
applique / plafonnier; acier, blanc / verre avec cristaux, blanc, clair

H 95, Ø 315



16W 1500lm

95576 NERINI

wall / ceiling light; steel, white / glass with crystals, white, black, clear
Wand- / Deckenleuchte; Stahl, weiss / Glas mit Kristallen, weiss, schwarz, klar
applique / plafonnier; acier, blanc / verre avec cristaux, blanc, noir, clair

H 90, Ø 315



16W 1500lm



9 002759 956899



Ø 315



9 002759 955762



Ø 315

SORRENTA 1, NERINI

These luminaires come with high quality glass crystals.

Diese Leuchten sind mit hochwertigen Glaskristallen ausgestattet.

Ces luminaires viennent avec des cristaux de verre de haute qualité.



98527

LED

incl./inkl./inclus



 TUNABLE WHITE	 STEP DIMMING	 NIGHT LIGHT FUNCTION	98527 <hr/> 98685
--	---	---	------------------------------------

1. warmwhite (2700K/100%)
 2. neutralwhite 3850K
 (2700K/50% + 5000K/50%)
 3. coldwhite (5000K/100%)



98685

LED

incl./inkl./inclus



98527 CANICOSA 2

wall / ceiling light; plastic, steel, black, gold / plastic with granille, transparent

Wand- / Deckenleuchte; Kunststoff, Stahl, schwarz, gold / Kunststoff mit Granille, transparent

applique / plafonnier; plastique, acier, noir, or / plastique avec granille, transparent

H 90, Ø 495

				
24,5W	3000lm		remote	

98685 CANICOSA 2

wall / ceiling light; plastic, steel, black, gold / plastic with granille, transparent

Wand- / Deckenleuchte; Kunststoff, Stahl, schwarz, gold / Kunststoff mit Granille, transparent

applique / plafonnier; plastique, acier, noir, or / plastique avec granille, transparent

H 145, Ø 765

				
37W	4600lm		remote	



9 002759 985271

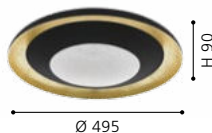

9 002759 986858

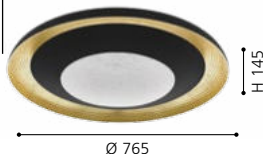



98023



98487



98488



98023 MONTENOVO

wall / ceiling light; steel, white / glass, white, gold
Wand- / Deckenleuchte; Stahl, weiss / Glas, weiss, gold
applique / plafonnier; acier, blanc / verre, blanc, or

H 100, Ø 395



16W 1500lm



9 002759 980238



98487 POZONDON

ceiling light; steel, gold-coloured / plastic, white
Deckenleuchte; Stahl, goldfarben / Kunststoff, weiss
plafonnier; acier, doré / plastique, blanc

H 100, Ø 380



18W 2000lm



9 002759 984878

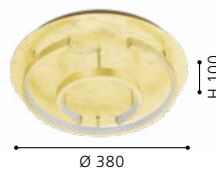

98488 POZONDON

ceiling light; steel, gold-coloured / plastic, white
Deckenleuchte; Stahl, goldfarben / Kunststoff, weiss
plafonnier; acier, doré / plastique, blanc

H 120, Ø 520



24W 2850lm



9 002759 984885

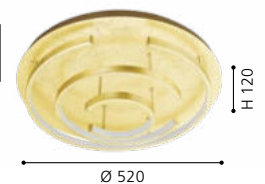

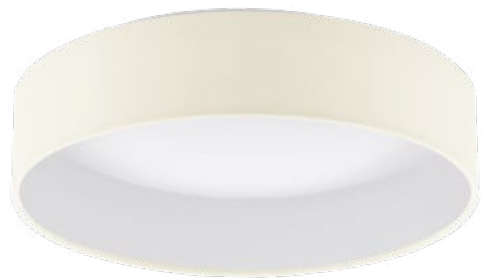

93392

LED

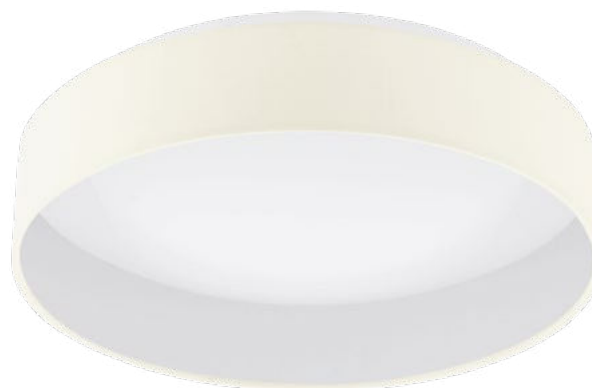

96537

LED

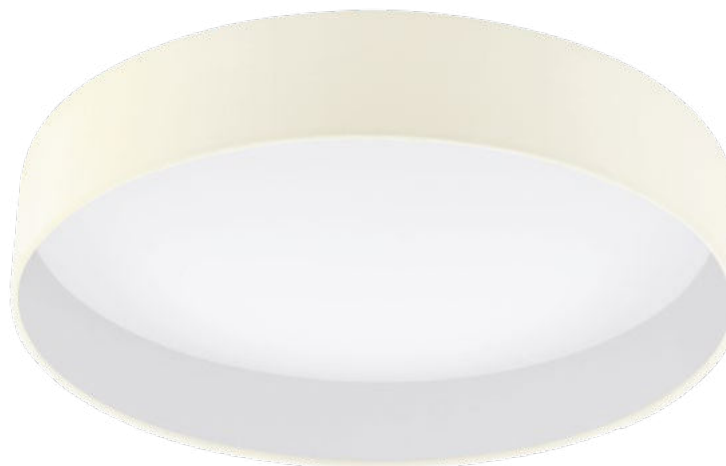

93394

LED

PALOMARO, PALOMARO 1

Convenient light effect due to the indirect illumination

Angenehmer Lichteffect durch indirekte Beleuchtung

Effet de lumière pratique en raison de l'éclairage indirect

93392 PALOMARO

ceiling light; plastic, white / fabric, creme
Deckenleuchte; Kunststoff, weiss / Textil, creme
plafonnier; plastique, blanc / tissu, crème

H 90, Ø 320

LED

11W

warm
WHITE

950lm



96537 PALOMARO 1

ceiling light; plastic, white / fabric, creme
Deckenleuchte; Kunststoff, weiss / Textil, creme
plafonnier; plastique, blanc / tissu, crème

H 100, Ø 405

LED

18W

warm
WHITE

2000lm



93394 PALOMARO

ceiling light; plastic, white / fabric, creme
Deckenleuchte; Kunststoff, weiss / Textil, creme
plafonnier; plastique, blanc / tissu, crème

H 110, Ø 500

LED

24W

warm
WHITE

2100lm



9 002759 933920



9 002759 965372

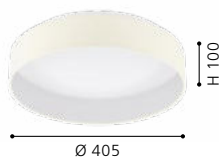

9 002759 933944

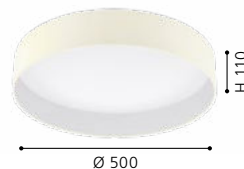



96539



93949



93952



93949 PALOMARO

ceiling light; plastic, white / fabric, taupe
Deckenleuchte; Kunststoff, weiss / Textil, taupe
plafonnier; plastique, blanc / tissu, taupe

H 90, Ø 320



11W 950lm



9 002759 939496



96539 PALOMARO 1

ceiling light; plastic, white / fabric, taupe
Deckenleuchte; Kunststoff, weiss / Textil, taupe
plafonnier; plastique, blanc / tissu, taupe

H 100, Ø 405



18W 2000lm



9 002759 965396



93952 PALOMARO

ceiling light; plastic, white / fabric, taupe
Deckenleuchte; Kunststoff, weiss / Textil, taupe
plafonnier; plastique, blanc / tissu, taupe

H 110, Ø 500



24W 2100lm



9 002759 939526





96538



93395



93397



93395 PALOMARO

ceiling light; plastic, white / fabric, anthracite
Deckenleuchte; Kunststoff, weiss / Textil, anthrazit
plafonnier; plastique, blanc / tissu, anthracite

H 90, Ø 320



11W



950lm



96538 PALOMARO 1

ceiling light; plastic, white / fabric, anthracite
Deckenleuchte; Kunststoff, weiss / Textil, anthrazit
plafonnier; plastique, blanc / tissu, anthracite

H 100, Ø 405



18W



2000lm



93397 PALOMARO

ceiling light; plastic, white / fabric, anthracite
Deckenleuchte; Kunststoff, weiss / Textil, anthrazit
plafonnier; plastique, blanc / tissu, anthracite

H 110, Ø 500



24W



2100lm



9 002759 933951



9 002759 965389

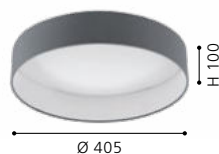

9 002759 933975

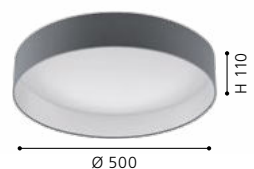



PALOMARO, PALOMARO 1

Convenient light effect due to the indirect illumination

Angenehmer Lichteffekt durch indirekte Beleuchtung

Effet de lumière pratique en raison de l'éclairage indirect



97479



97838



98409

97479 PASTORE

ceiling light; steel, white / fabric, anthracite-brown, white, grey
Deckenleuchte; Stahl, weiss / Textil, anthrazit-braun, weiss, grau
plafonnier; acier, blanc / tissu, anthracite marron, blanc, gris

L 610, B 495, H 255



E27



3x 60W

97838 PASTORE

ceiling light; steel, white / fabric, brown, grey, white, black
Deckenleuchte; Stahl, weiss / Textil, braun, grau, weiss, schwarz
plafonnier; acier, blanc / tissu, marron, gris, blanc, noir

H 285, Ø 990



E27



6x 40W

98409 PASTORE 1

ceiling light; steel, white / fabric, taupe
Deckenleuchte; Stahl, weiss / Textil, taupe
plafonnier; acier, blanc / tissu, taupe

H 250, Ø 990



E27



6x 40W



9 002759 974794



L 610



9 002759 978389



Ø 990



9 002759 984090



Ø 990



99508



97479 | 97838 | 98409
99508 | 99509

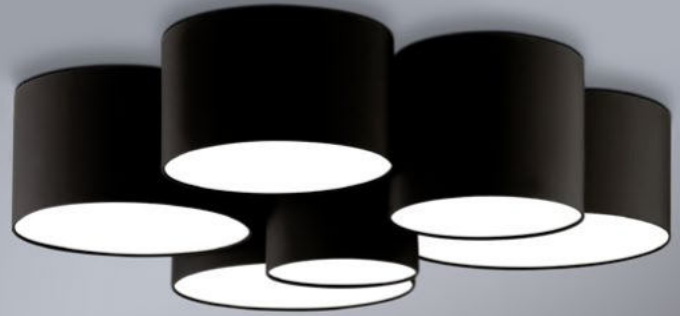

99509



99508 PASTORE 2

ceiling light; steel, white / fabric, black, white
Deckenleuchte; Stahl, weiss / Textil, schwarz, weiss
plafonnier; acier, blanc / tissu, noir, blanc

L 610, B 495, H 255



E27 3x 60W



9 002759 995089



99509 PASTORE 2

ceiling light; steel, white / fabric, black, white
Deckenleuchte; Stahl, weiss / Textil, schwarz, weiss
plafonnier; acier, blanc / tissu, noir, blanc

H 285, Ø 990



E27 6x 40W



9 002759 995096

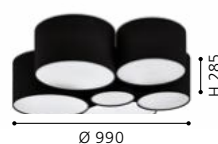



97526



incl./inkl./inclus



97527



incl./inkl./inclus



97528



incl./inkl./inclus



				<u>97526</u>	<u>97541</u>
TUNABLE WHITE	DIMMABLE	TIMER FUNCTION	NIGHT LIGHT FUNCTION	<u>97527</u>	<u>97542</u>
3000 - 5000 K	10 - 100 %	off after 30sec.		<u>97528</u>	<u>97543</u>

97526 GIRON

ceiling light; steel, white / plastic, white
Deckenleuchte; Stahl, weiss / Kunststoff, weiss
plafonnier; acier, blanc / plastique, blanc

H 75, Ø 570



40W



4000lm



remote

97527 GIRON

ceiling light; steel, white / plastic, white
Deckenleuchte; Stahl, weiss / Kunststoff, weiss
plafonnier; acier, blanc / plastique, blanc

H 85, Ø 760



60W



5800lm



remote

97528 GIRON

ceiling light; steel, white / plastic, white
Deckenleuchte; Stahl, weiss / Kunststoff, weiss
plafonnier; acier, blanc / plastique, blanc

H 120, Ø 1000



80W



7800lm



remote



9 002759 975265



Ø 570



9 002759 975272



Ø 760



9 002759 975289



Ø 1000



97541



incl./inkl./inclus



97542



incl./inkl./inclus



97543



incl./inkl./inclus

97541 GIRON-S

ceiling light; steel, white / plastic with crystal effect, white
Deckenleuchte; Stahl, weiss / Kunststoff m.Kristalleffekt, weiss
plafonnier; acier, blanc / plastique avec effet cristal, blanc

H 75, Ø 570



40W



4000lm



remote

97542 GIRON-S

ceiling light; steel, white / plastic with crystal effect, white
Deckenleuchte; Stahl, weiss / Kunststoff m.Kristalleffekt, weiss
plafonnier; acier, blanc / plastique avec effet cristal, blanc

H 85, Ø 760



60W



5800lm



remote

97543 GIRON-S

ceiling light; steel, white / plastic with crystal effect, white
Deckenleuchte; Stahl, weiss / Kunststoff m.Kristalleffekt, weiss
plafonnier; acier, blanc / plastique avec effet cristal, blanc

H 120, Ø 1000



80W



7800lm



remote



9 002759 975418



Ø 570



9 002759 975425



Ø 760



9 002759 975432



Ø 1000



97871



97872



97873



97871 FRANIA

wall / ceiling light; steel, white / plastic, white
Wand- / Deckenleuchte; Stahl, weiss / Kunststoff, weiss
applique / plafonnier; acier, blanc / plastique, blanc

H 70, Ø 280



11,5W 1350lm

97872 FRANIA

wall / ceiling light; steel, white / plastic, white
Wand- / Deckenleuchte; Stahl, weiss / Kunststoff, weiss
applique / plafonnier; acier, blanc / plastique, blanc

H 70, Ø 330



17,3W 2000lm

97873 FRANIA

wall / ceiling light; steel, white / plastic, white
Wand- / Deckenleuchte; Stahl, weiss / Kunststoff, weiss
applique / plafonnier; acier, blanc / plastique, blanc

H 70, Ø 430



33,5W 3900lm



9 002759 978716



Ø 280



9 002759 978723



Ø 330



9 002759 978730



Ø 430



98446



98446 FRANIA

wall / ceiling light; steel, white / plastic, white
Wand- / Deckenleuchte; Stahl, weiss / Kunststoff, weiss
applique / plafonnier; acier, blanc / plastique, blanc

H 70, Ø 550



49,5W



5700lm



9 002759 984465





97877



97878



97879



97877 FRANIA-S

wall / ceiling light; steel, white / plastic with crystal effect, white
Wand- / Deckenleuchte; Stahl, weiss / Kunststoff m. Kristalleffekt, weiss
applique / plafonnier; acier, blanc / plastique avec effet cristal, blanc

H 70, Ø 280



11,5W 1350lm

97878 FRANIA-S

wall / ceiling light; steel, white / plastic with crystal effect, white
Wand- / Deckenleuchte; Stahl, weiss / Kunststoff m. Kristalleffekt, weiss
applique / plafonnier; acier, blanc / plastique avec effet cristal, blanc

H 70, Ø 330



17,3W 2000lm

97879 FRANIA-S

wall / ceiling light; steel, white / plastic with crystal effect, white
Wand- / Deckenleuchte; Stahl, weiss / Kunststoff m. Kristalleffekt, weiss
applique / plafonnier; acier, blanc / plastique avec effet cristal, blanc

H 70, Ø 430



33,5W 3900lm



9 002759 978778



Ø 280



9 002759 978785



Ø 330



9 002759 978792



Ø 430



98448

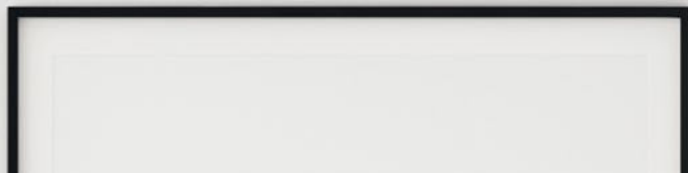

98448 FRANIA-S

wall / ceiling light; steel, white / plastic with crystal effect, white
Wand- / Deckenleuchte; Stahl, weiss / Kunststoff m.Kristalleffekt, weiss
applique / plafonnier; acier, blanc / plastique avec effet cristal, blanc

H 70, Ø 550



49,5W 5700lm





97874



97875



97876



97874 FRANIA

wall / ceiling light; steel, white / plastic, white
Wand- / Deckenleuchte; Stahl, weiss / Kunststoff, weiss
applique / plafonnier; acier, blanc / plastique, blanc

L 280, B 280, H 70



11,5W 1350lm

97875 FRANIA

wall / ceiling light; steel, white / plastic, white
Wand- / Deckenleuchte; Stahl, weiss / Kunststoff, weiss
applique / plafonnier; acier, blanc / plastique, blanc

L 330, B 330, H 70



17,3W 2000lm

97876 FRANIA

wall / ceiling light; steel, white / plastic, white
Wand- / Deckenleuchte; Stahl, weiss / Kunststoff, weiss
applique / plafonnier; acier, blanc / plastique, blanc

L 430, B 430, H 70



33,5W 3900lm



9 002759 978747



L 280

B 280



9 002759 978754



L 330

B 330



9 002759 978761



L 430

B 430



98447



98447 FRANIA

wall / ceiling light; steel, white / plastic, white
Wand- / Deckenleuchte; Stahl, weiss / Kunststoff, weiss
applique / plafonnier; acier, blanc / plastique, blanc

L 530, B 530, H 70



49,5W 5700lm





97881



97882



97883



97881 FRANIA-S

wall / ceiling light; steel, white / plastic with crystal effect, white
Wand- / Deckenleuchte; Stahl, weiss / Kunststoff m. Kristalleffekt, weiss
applique / plafonnier; acier, blanc / plastique avec effet cristal, blanc

L 280, B 280, H 70



11,5W 1350lm

97882 FRANIA-S

wall / ceiling light; steel, white / plastic with crystal effect, white
Wand- / Deckenleuchte; Stahl, weiss / Kunststoff m. Kristalleffekt, weiss
applique / plafonnier; acier, blanc / plastique avec effet cristal, blanc

L 330, B 330, H 70



17,3W 2000lm

97883 FRANIA-S

wall / ceiling light; steel, white / plastic with crystal effect, white
Wand- / Deckenleuchte; Stahl, weiss / Kunststoff m. Kristalleffekt, weiss
applique / plafonnier; acier, blanc / plastique avec effet cristal, blanc

L 430, B 430, H 70



33,5W 3900lm



9 002759 978815



9 002759 978822



9 002759 978839





98449

LED

98449 FRANIA-S

wall / ceiling light; steel, white / plastic with crystal effect, white

Wand- / Deckenleuchte; Stahl, weiss / Kunststoff m.Kristalleffekt, weiss

applique / plafonnier; acier, blanc / plastique avec effet cristal, blanc

L 530, B 530, H 70

LED

warm
WHITE



49,5W 5700lm



9 002759 984496





99341

LED

incl./inkl./inclus



99342

LED

incl./inkl./inclus



97577

LED

incl./inkl./inclus



TUNABLE WHITE
2700 - 6500 K

STEP DIMMING
10/25/50/100 %

97577

97578

99341 ZAMUDILO

ceiling light; steel, white / plastic with crystal effect, white, silver
Deckenleuchte; Stahl, weiss / Kunststoff m. Kristalleffekt, weiss, silber
plafonnier; acier, blanc / plastique avec effet cristal, blanc, argent

H 90, Ø 400

LED
18W

tunable WHITE
1900lm



CONTROL UNIT
remote

99342 ZAMUDILO

ceiling light; steel, white / plastic with crystal effect, white, silver
Deckenleuchte; Stahl, weiss / Kunststoff m. Kristalleffekt, weiss, silber
plafonnier; acier, blanc / plastique avec effet cristal, blanc, argent

H 90, Ø 500

LED
24W

tunable WHITE
2800lm



CONTROL UNIT
remote

97577 SILERAS

wall / ceiling light; steel, white / plastic with crystal effect, white
Wand- / Deckenleuchte; Stahl, weiss / Kunststoff m. Kristalleffekt, weiss
applique / plafonnier; acier, blanc / plastique avec effet cristal, blanc

H 85, Ø 450

LED
21W

tunable WHITE
2500lm



CONTROL UNIT
remote



9 002759 993412



Ø 400



9 002759 993429



Ø 500



9 002759 975777



Ø 450



97578



99108



99109



97578 SILERAS

wall / ceiling light; steel, white / plastic with crystal effect, white
Wand- / Deckenleuchte; Stahl, weiss / Kunststoff m.Kristalleffekt, weiss
applique / plafonnier; acier, blanc / plastique avec effet cristal, blanc

H 85, Ø 600



34W 4600lm

99108 RUIDERA

ceiling light; steel, white / plastic, white, silver
Deckenleuchte; Stahl, weiss / Kunststoff, weiss, silber
plafonnier; acier, blanc / plastique, blanc, argent

H 90, Ø 480



22W 2400lm

99109 RUIDERA

ceiling light; steel, white / plastic, white, silver
Deckenleuchte; Stahl, weiss / Kunststoff, weiss, silber
plafonnier; acier, blanc / plastique, blanc, argent

L 480, B 480, H 90



22W 2400lm



9 002759 975784



Ø 600



9 002759 991081



Ø 480



9 002759 991098



L 480

B 480



95973



incl./inkl./inclus



95973 VOLTAGO 2

wall / ceiling light; steel, white / plastic with crystal effect, white
Wand- / Deckenleuchte; Stahl, weiss / Kunststoff m.Kristalleffekt, weiss
applique / plafonnier; acier, blanc / plastique avec effet cristal, blanc

H 125, Ø 580



30W



3500lm



remote

95971 VOLTAGO 2

wall / ceiling light; steel, white / plastic with crystal effect, white
Wand- / Deckenleuchte; Stahl, weiss / Kunststoff m.Kristalleffekt, weiss
applique / plafonnier; acier, blanc / plastique avec effet cristal, blanc

H 95, Ø 295



14W



1500lm



remote

95972 VOLTAGO 2

wall / ceiling light; steel, white / plastic with crystal effect, white
Wand- / Deckenleuchte; Stahl, weiss / Kunststoff m.Kristalleffekt, weiss
applique / plafonnier; acier, blanc / plastique avec effet cristal, blanc

H 105, Ø 380



20W



2500lm



remote



9 002759 959739



Ø 580



9 002759 959715



Ø 295



9 002759 959722



Ø 380



95971



95972



95975

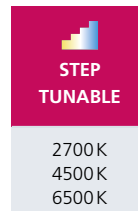

95971

95972

95973

95975

95975 VOLTAGO 2

wall / ceiling light; steel, white / plastic with crystal effect, white
 Wand- / Deckenleuchte; Stahl, weiss / Kunststoff m. Kristalleffekt, weiss
 applique / plafonnier; acier, blanc / plastique avec effet cristal, blanc

L 375, B 375, H 90



20W



2200lm



remote



VOLTAGO 2

These luminaires come with an interesting glitter-effect.

Diese Leuchten sind mit einem interessanten Glitzer-Effekt ausgestattet.

Ces luminaires viennent avec un effet scintillant intéressant.



98323



incl./inkl./inclus



98324



incl./inkl./inclus



97737



incl./inkl./inclus

98323 LANCIANO 1

wall / ceiling light; steel, white, transparent / plastic with crystal effect, white, chrome

Wand- / Deckenleuchte; Stahl, weiss, transparent / Kunststoff m. Kristalleffekt, weiss, chrom

applique / plafonnier; acier, blanc, transparent / plastique avec effet cristal, blanc, chrome

H 75, Ø 400



24W



1900lm



remote

98324 LANCIANO 1

wall / ceiling light; steel, white, transparent / plastic with crystal effect, white, chrome

Wand- / Deckenleuchte; Stahl, weiss, transparent / Kunststoff m. Kristalleffekt, weiss, chrom

applique / plafonnier; acier, blanc, transparent / plastique avec effet cristal, blanc, chrome

H 80, Ø 560



36W



3300lm



remote

97737 LANCIANO

ceiling light; steel, plastic, white, transparent / plastic with crystal effect, white, silver

Deckenleuchte; Stahl, Kunststoff, weiss, transparent / Kunststoff m. Kristalleffekt, weiss, silber

plafonnier; acier, plastique, blanc, transparent / plastique avec effet cristal, blanc, argent

H 100, Ø 660



40W



4000lm



remote



9 002759 983239



Ø 400



9 002759 983246



Ø 560



9 002759 977375



Ø 660



97738

LED

incl./inkl./inclus



97738 LANCIANO





ceiling light; steel, white, transparent / plastic with crystal effect, white, silver

Deckenleuchte; Stahl, weiss, transparent / Kunststoff m. Kristalleffekt, weiss, silber

plafonnier; acier, blanc, transparent / plastique avec effet cristal, blanc, argent

H 105, Ø 860



 TUNABLE WHITE	 DIMMABLE	 TIMER FUNCTION	 NIGHT LIGHT FUNCTION
	10 - 100 %	off after 30sec.	

98323

98324

97737

97738



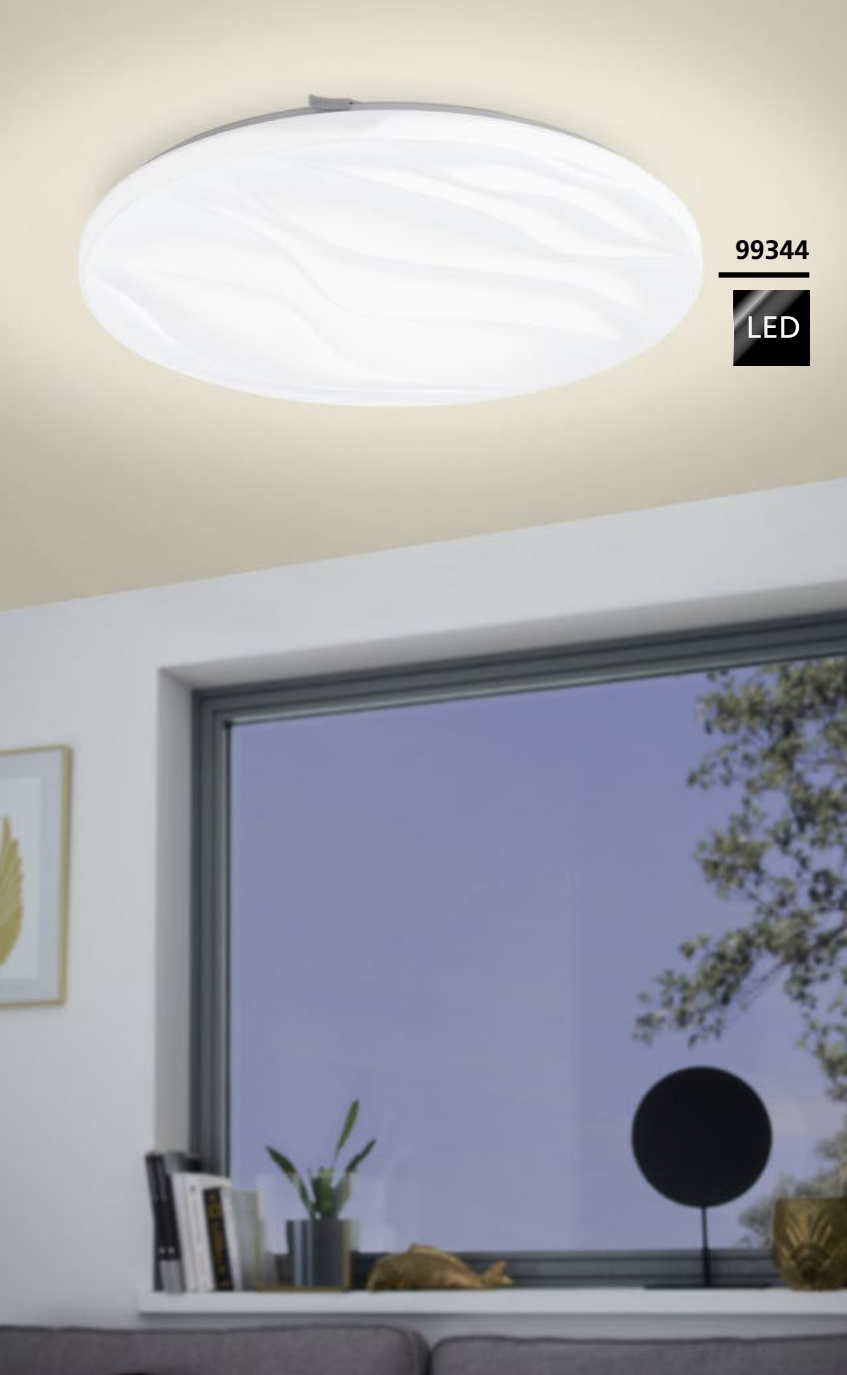

99344



99343



99344 BENARIBA

wall / ceiling light; steel, white / plastic, white
Wand- / Deckenleuchte; Stahl, weiss / Kunststoff, weiss
applique / plafonnier; acier, blanc / plastique, blanc

Ø 440



22W



2450lm



99343 BENARIBA

wall / ceiling light; steel, white / plastic, white
Wand- / Deckenleuchte; Stahl, weiss / Kunststoff, weiss
applique / plafonnier; acier, blanc / plastique, blanc

Ø 330



17,3W



2000lm



99465 BENARIBA

wall / ceiling light; steel, white / plastic, white
Wand- / Deckenleuchte; Stahl, weiss / Kunststoff, weiss
applique / plafonnier; acier, blanc / plastique, blanc

H 70, Ø 550



36W



4100lm



9 002759 993443



Ø 440



9 002759 993436



Ø 330



9 002759 994655



Ø 550



99465

LED



96026

LED



96025

LED



96025 CAPASSO 1

wall / ceiling light; steel, white / plastic, white, chrome
Wand- / Deckenleuchte; Stahl, weiss / Kunststoff, weiss, chrom
applique / plafonnier; acier, blanc / plastique, blanc, chrome

H 70, Ø 340



23W 2500lm



9 002759 960254



Ø 340

96026 CAPASSO 1

wall / ceiling light; steel, white / plastic, white, chrome
Wand- / Deckenleuchte; Stahl, weiss / Kunststoff, weiss, chrom
applique / plafonnier; acier, blanc / plastique, blanc, chrome

H 70, Ø 400



24W 2600lm



9 002759 960261



Ø 400



99405

LED



95677

LED

99404 COMPETA 2

wall / ceiling light; steel, white / plastic, white, black, clear
Wand- / Deckenleuchte; Stahl, weiss / Kunststoff, weiss, schwarz, klar
applique / plafonnier; acier, blanc / plastique, blanc, noir, clair

H 85, Ø 335

LED

18W

warm
WHITE

2000lm



9 002759 994044



Ø 335

99405 COMPETA 2

wall / ceiling light; steel, white / plastic, white, black, clear
Wand- / Deckenleuchte; Stahl, weiss / Kunststoff, weiss, schwarz, klar
applique / plafonnier; acier, blanc / plastique, blanc, noir, clair

L 340, B 340, H 75

LED

24W

warm
WHITE

2600lm



9 002759 994051



L 340

B 340

95677 COMPETA 1

wall / ceiling light; steel, white / plastic, white, silver, clear
Wand- / Deckenleuchte; Stahl, weiss / Kunststoff, weiss, silber, klar
applique / plafonnier; acier, blanc / plastique, blanc, argent, clair

H 75, Ø 335

LED

18W

warm
WHITE

2000lm



9 002759 956776



Ø 335



98258

TUNABLE WHITE **STEP DIMMING**

- warmwhite (2700K/100%)
- neutralwhite 3850K (2700K/50% + 5000K/50%)
- coldwhite (5000K/100%)

TIMER FUNCTION **NIGHT LIGHT FUNCTION**

off after 30sec.

95679 COMPETA 1

wall / ceiling light; steel, white / plastic, white, silver, clear
 Wand- / Deckenleuchte; Stahl, weiss / Kunststoff, weiss, silber, klar
 applique / plafonnier; acier, blanc / plastique, blanc, argent, clair

L 340, B 340, H 80



24W 2600lm

95681 COMPETA 1

wall / ceiling light; steel, white / plastic, white, silver, clear
 Wand- / Deckenleuchte; Stahl, weiss / Kunststoff, weiss, silber, klar
 applique / plafonnier; acier, blanc / plastique, blanc, argent, clair

L 430, B 430, H 95



24W 2600lm

98258 COGOLETO

wall / ceiling light; steel, plastic, white, silver / plastic, white
 Wand- / Deckenleuchte; Stahl, Kunststoff, weiss, silber / Kunststoff, weiss
 applique / plafonnier; acier, plastique, blanc, argent / plastique, blanc

L 490, B 490, H 60



30W 3200lm remote



9 002759 956790



9 002759 956813



9 002759 982584





96032



96033



96034



96032 COMPETA 1

wall / ceiling light; steel, white / plastic, white, satined nickel
Wand- / Deckenleuchte; Stahl, weiss / Kunststoff, weiss, nickel-
matt
applique / plafonnier; acier, blanc / plastique, blanc, nickel mat

H 55, Ø 245



18W



2000lm



96033 COMPETA 1

wall / ceiling light; steel, white / plastic, white, satined nickel
Wand- / Deckenleuchte; Stahl, weiss / Kunststoff, weiss, nickel-
matt
applique / plafonnier; acier, blanc / plastique, blanc, nickel mat

H 55, Ø 325



23W



2500lm



96034 COMPETA 1

wall / ceiling light; steel, white / plastic, white, satined nickel
Wand- / Deckenleuchte; Stahl, weiss / Kunststoff, weiss, nickel-
matt
applique / plafonnier; acier, blanc / plastique, blanc, nickel mat

H 55, Ø 430



24W



2600lm



9 002759 960322



Ø 245



9 002759 960339



Ø 325



9 002759 960346



Ø 430



95682

LED



95684

LED

95682 PALERMO 2

wall / ceiling light; steel, white / plastic, white, chrome
Wand- / Deckenleuchte; Stahl, weiss / Kunststoff, weiss, chrom
applique / plafonnier; acier, blanc / plastique, blanc, chrome

H 70, Ø 280



18W 2000lm



9 002759 956820



Ø 280

95684 PALERMO 2

wall / ceiling light; steel, white / plastic, white, chrome
Wand- / Deckenleuchte; Stahl, weiss / Kunststoff, weiss, chrom
applique / plafonnier; acier, blanc / plastique, blanc, chrome

H 60, Ø 410



24W 2600lm



9 002759 956844



Ø 410



96023

LED



98326

LED



96024

LED

96023 CAPASSO

wall / ceiling light; steel, white / plastic, white, chrome
Wand- / Deckenleuchte; Stahl, weiss / Kunststoff, weiss, chrom
applique / plafonnier; acier, blanc / plastique, blanc, chrome

H 65, Ø 340



23W 2500lm

96024 CAPASSO

wall / ceiling light; steel, white / plastic, white, chrome
Wand- / Deckenleuchte; Stahl, weiss / Kunststoff, weiss, chrom
applique / plafonnier; acier, blanc / plastique, blanc, chrome

H 70, Ø 400



24W 2600lm

98326 NIEVES

wall / ceiling light; steel, white / plastic, white, silver
Wand- / Deckenleuchte; Stahl, weiss / Kunststoff, weiss, silber
applique / plafonnier; acier, blanc / plastique, blanc, argent

H 70, Ø 510



33W 3700lm



9 002759 960230



Ø 340



9 002759 960247



Ø 400



9 002759 983260



Ø 510



98325

LED

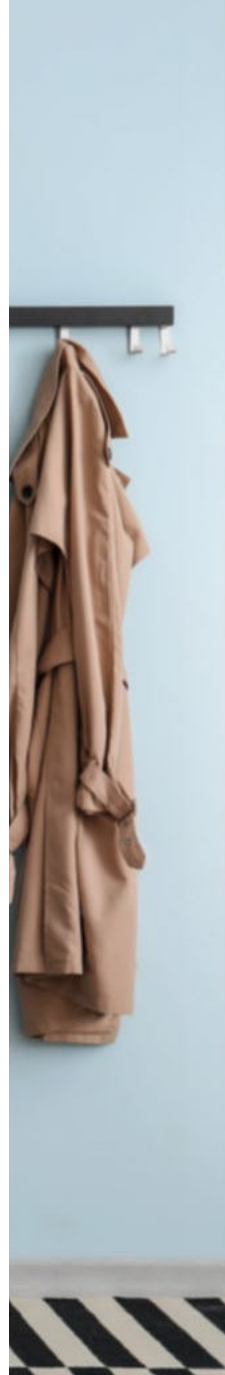

99699

98325 NIEVES

wall / ceiling light; steel, white / plastic, white, silver
Wand- / Deckenleuchte; Stahl, weiss / Kunststoff, weiss, silber
applique / plafonnier; acier, blanc / plastique, blanc, argent

H 65, Ø 410



24W 2400lm



9 002759 983253



Ø 410

99699 NIEVES

wall / ceiling light; steel, white / plastic, white, silver
Wand- / Deckenleuchte; Stahl, weiss / Kunststoff, weiss, silber
applique / plafonnier; acier, blanc / plastique, blanc, argent

H 60, Ø 310



11W 1350lm



9 002759 996994



Ø 310





99406

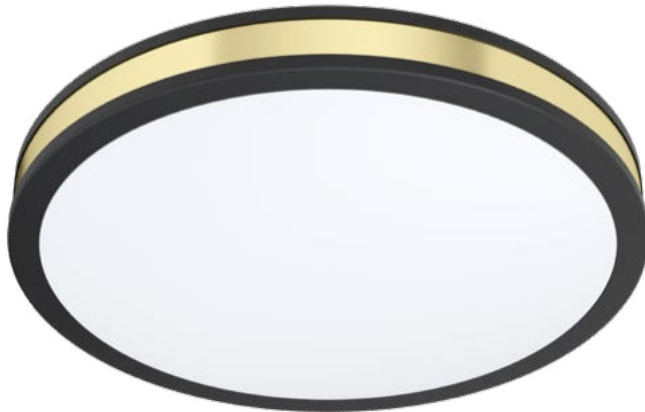

99407



98603



99406 PESCAITO

wall / ceiling light; steel, black / plastic, white, gold
Wand- / Deckenleuchte; Stahl, schwarz / Kunststoff, weiss, gold
applique / plafonnier; acier, noir / plastique, blanc, or

H 65, Ø 280



11W 1350lm

99407 PESCAITO

wall / ceiling light; steel, black / plastic, white, gold
Wand- / Deckenleuchte; Stahl, schwarz / Kunststoff, weiss, gold
applique / plafonnier; acier, noir / plastique, blanc, or

H 65, Ø 380



24W 2400lm

98603 MUSURITA

ceiling light; plastic, steel, black / plastic, white
Deckenleuchte; Kunststoff, Stahl, schwarz / Kunststoff, weiss
plafonnier; plastique, acier, noir / plastique, blanc

H 60, Ø 340



16,8W 2000lm



9 002759 994068



Ø 280



9 002759 994075



Ø 380



9 002759 986032



Ø 340



98604



98602



98601

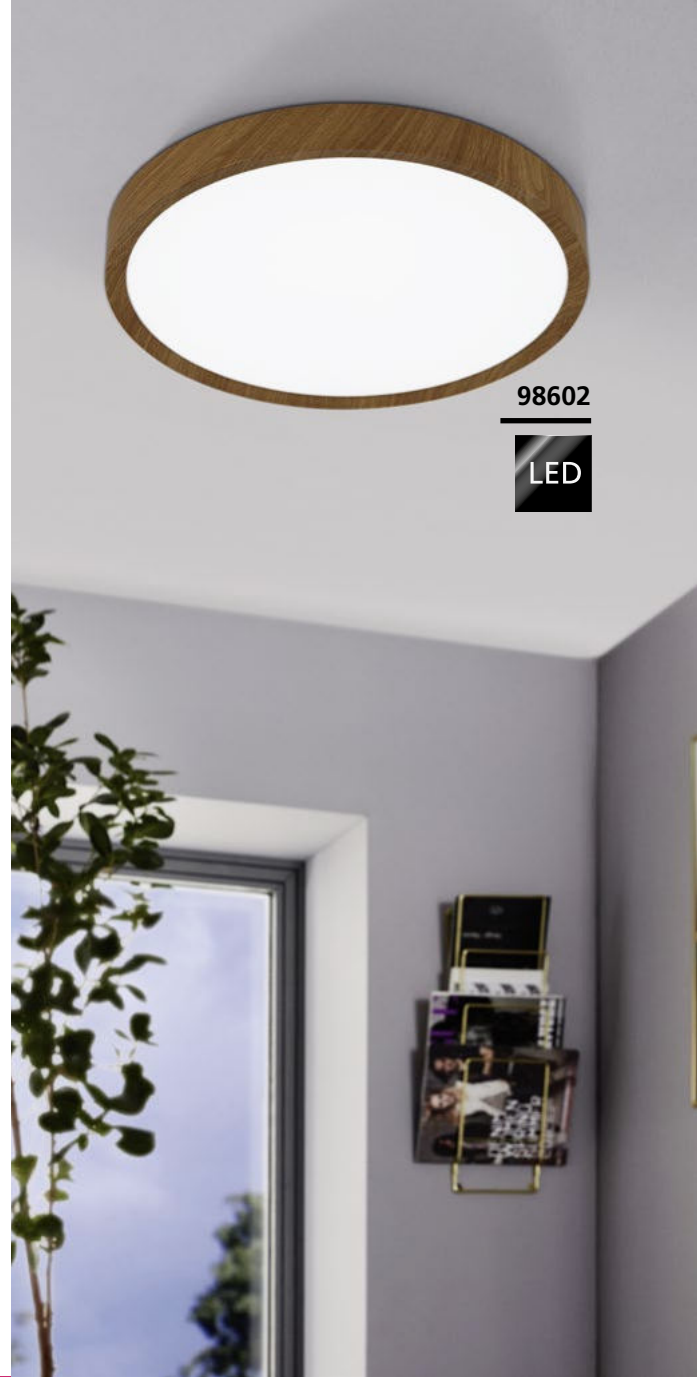

98604 MUSURITA

ceiling light; plastic, steel, black / plastic, white
Deckenleuchte; Kunststoff, Stahl, schwarz / Kunststoff, weiss
plafonnier; plastique, acier, noir / plastique, blanc

H 75, Ø 440



33,5W 3900lm

98601 MUSURITA

ceiling light; plastic, steel, natural wood look / plastic, white
Deckenleuchte; Kunststoff, Stahl, Holzoptik natur / Kunststoff, weiss
plafonnier; plastique, acier, aspect bois naturel / plastique, blanc

H 60, Ø 340



16,8W 2000lm

98602 MUSURITA

ceiling light; plastic, steel, natural wood look / plastic, white
Deckenleuchte; Kunststoff, Stahl, Holzoptik natur / Kunststoff, weiss
plafonnier; plastique, acier, aspect bois naturel / plastique, blanc

H 75, Ø 440



33,5W 3900lm



9 002759 986049



Ø 440



9 002759 986018



Ø 340



9 002759 986025



Ø 440



99782



99783



99779



99782 LAURITO

ceiling light; steel, white / plastic, grey, white
Deckenleuchte; Stahl, weiss / Kunststoff, grau, weiss
plafonnier; acier, blanc / plastique, gris, blanc

Ø 490



24W



2160lm



remote



99783 LAURITO

ceiling light; steel, white / plastic, black, white
Deckenleuchte; Stahl, weiss / Kunststoff, schwarz, weiss
plafonnier; acier, blanc / plastique, noir, blanc

Ø 490



24W



2160lm



remote



99779 SELUCI

ceiling light; steel, white / plastic, white, clear
Deckenleuchte; Stahl, weiss / Kunststoff, weiss, klar
plafonnier; acier, blanc / plastique, blanc, clair

H 70, Ø 490



4x 10W



5000lm



remote



9 002759 997823



Ø 490



9 002759 997830



Ø 490



9 002759 997793



Ø 490



99781

LED

incl./inkl./inclus



99781 SELUCI

ceiling light; steel, black / plastic, white, clear
Deckenleuchte; Stahl, schwarz / Kunststoff, weiss, klar
plafonnier; acier, noir / plastique, blanc, clair

H 70, Ø 490

LED

4x 10W

tunable
WHITE

5000lm



CONTROL
UNIT

remote



9 002759 997816



Ø 490

SELUCI

Convenient light effect due to the indirect illumination.

Angenehmer Lichteffect durch indirekte Beleuchtung.

Effet de lumière pratique en raison de l'éclairage indirect.



99623



99621



99622



99623 VALCASOTTO

ceiling light; steel, Mokka colour / plastic, white
 Deckenleuchte; Stahl, Mokkafarben / Kunststoff, weiss
 plafonnier; acier, mocha couleur / plastique, blanc

H 75, Ø 350



99621 VALCASOTTO

ceiling light; steel, black / plastic, white
 Deckenleuchte; Stahl, schwarz / Kunststoff, weiss
 plafonnier; acier, noir / plastique, blanc

H 75, Ø 350



99622 VALCASOTTO

ceiling light; steel, brown / plastic, white
 Deckenleuchte; Stahl, braun / Kunststoff, weiss
 plafonnier; acier, marron / plastique, blanc

H 75, Ø 350





99703



99704



99704 PENJAMO

ceiling light; steel, Mokka colour / plastic with crystal effect, white
Deckenleuchte; Stahl, Mokkafarben / Kunststoff m. Kristalleffekt, weiss
plafonnier; acier, mocha couleur / plastique avec effet cristal, blanc
H 65, Ø 465



17,28 W 2000 lm

99703 PENJAMO

ceiling light; steel, black / plastic with crystal effect, white
Deckenleuchte; Stahl, schwarz / Kunststoff m. Kristalleffekt, weiss
plafonnier; acier, noir / plastique avec effet cristal, blanc
H 65, Ø 465



17,28 W 2000 lm



9 002759 997045



Ø 465



9 002759 997038



Ø 465



99397



99397

The wall switch controls the luminaire's light colour.

Über den Wandschalter kann die Lichtfarbe der Leuchte gesteuert werden.

La couleur de lumière du luminaire peut être commandée par l'interrupteur mural.



99398



99398

The wall switch controls the luminaire's light colour.

Über den Wandschalter kann die Lichtfarbe der Leuchte gesteuert werden.

La couleur de lumière du luminaire peut être commandée par l'interrupteur mural.

99397 MENTALURGIA

wall / ceiling light; steel, white, chrome / plastic, white
Wand- / Deckenleuchte; Stahl, weiss, chrom / Kunststoff, weiss
applique / plafonnier; acier, blanc, chrome / plastique, blanc

L 495, B 465, H 65



9 002759 993979



99398 MENTALURGIA

wall / ceiling light; steel, white, chrome / plastic, white
Wand- / Deckenleuchte; Stahl, weiss, chrom / Kunststoff, weiss
applique / plafonnier; acier, blanc, chrome / plastique, blanc

L 490, B 490, H 65



9 002759 993986





99399

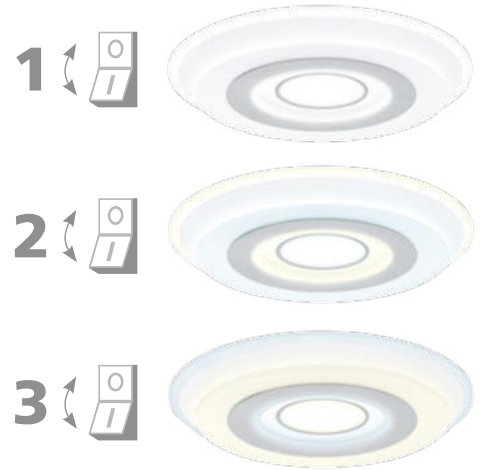

99399

The wall switch controls the luminaire's light colour.

Über den Wandschalter kann die Lichtfarbe der Leuchte gesteuert werden.

La couleur de lumière du luminaire peut être commandée par l'interrupteur mural.



95487



96851



99399 REDUCTA 2

wall / ceiling light; plastic, white
Wand- / Deckenleuchte; Kunststoff, weiss
applique / plafonnier; plastique, blanc

H 45, Ø 490



9 002759 993993



96851 LEGANES

ceiling light; steel, white / plastic, white
Deckenleuchte; Stahl, weiss / Kunststoff, weiss
plafonnier; acier, blanc / plastique, blanc

H 110, Ø 455



9 002759 968519



95487 TORONJA

ceiling light; steel, white
Deckenleuchte; Stahl, weiss
plafonnier; acier, blanc

H 205, Ø 550



9 002759 954871





81635



83404



81636

81635 ELLA

wall / ceiling light; steel, white / glass opal-matt, white
Wand- / Deckenleuchte; Stahl, weiss / Glas opal-matt, weiss
applique / plafonnier; acier, blanc / verre opale mat, blanc

H 92, Ø 200



E27

1x 60W

81636 ELLA

wall / ceiling light; steel, white / glass opal-matt, white
Wand- / Deckenleuchte; Stahl, weiss / Glas opal-matt, weiss
applique / plafonnier; acier, blanc / verre opale mat, blanc

H 117, Ø 280



E27

1x 60W

83404 ELLA

wall / ceiling light; steel, white / glass opal-matt, white
Wand- / Deckenleuchte; Stahl, weiss / Glas opal-matt, weiss
applique / plafonnier; acier, blanc / verre opale mat, blanc

H 127, Ø 350



E27

2x 60W



9 002759 816353



Ø 200



9 002759 816360



Ø 280



9 002759 834043



Ø 350



94973

94973 DURELO

ceiling light; plastic, white / glass, white
Deckenleuchte; Kunststoff, weiss / Glas, weiss
plafonnier; plastique, blanc / verre, blanc

H 195, Ø 160



E27



1x 28W



9 002759 949730





82944



82942

82944 PLANET

wall / ceiling light; steel, chrome / satin glass, white, clear
Wand- / Deckenleuchte; Stahl, chrom / Glas satiniert, weiss, klar
applique / plafonnier; acier, chrome / verre satiné, blanc, clair

H 100, Ø 370



E27

2x 25W

82942 PLANET

wall / ceiling light; steel, satin nickel / satin glass, white, clear
Wand- / Deckenleuchte; Stahl, nickel-matt / Glas satiniert, weiss, klar
applique / plafonnier; acier, nickel mat / verre satiné, blanc, clair

H 85, Ø 290



E27

1x 25W

31254 LED PLANET

wall / ceiling light; steel, satin nickel / satin glass, white, clear
Wand- / Deckenleuchte; Stahl, nickel-matt / Glas satiniert, weiss, klar
applique / plafonnier; acier, nickel mat / verre satiné, blanc, clair

H 85, Ø 290



11W



950lm



9 002759 829445



Ø 370



9 002759 829421



Ø 290



9 002759 312541



Ø 290



31254

LED



83155



83155 PLANET 1

wall / ceiling light; steel, chrome / glass painted, white, clear
Wand- / Deckenleuchte; Stahl, chrom / Glas lackiert, weiss, klar
applique / plafonnier; acier, chrome / verre laqué, blanc, clair

H 85, Ø 290



E27



1x 25W



9 002759 831554



Ø 290



83153



83154



83156

83156 PLANET 1

wall light; steel, chrome / glass painted, white, clear
Wandleuchte; Stahl, chrom / Glas lackiert, weiss, klar
applique; acier, chrome / verre laqué, blanc, clair

L 290, H 145, A 85



83153 PLANET 1

wall / ceiling light; steel, white / glass painted, white, clear
Wand- / Deckenleuchte; Stahl, weiss / Glas lackiert, weiss, klar
applique / plafonnier; acier, blanc / verre laqué, blanc, clair

H 85, Ø 290



83154 PLANET 1

wall light; steel, white / glass painted, white, clear
Wandleuchte; Stahl, weiss / Glas lackiert, weiss, klar
applique; acier, blanc / verre laqué, blanc, clair

L 290, H 145, A 85





83157



83159

83157 PLANET 1

wall / ceiling light; steel, brass / glass painted, white, clear
Wand- / Deckenleuchte; Stahl, messing / Glas lackiert, weiss, klar
applique / plafonnier; acier, laiton / verre laqué, blanc, clair

H 85, Ø 290



E27

1x 25W



9 002759 831578



Ø 290

83159 PLANET 1

wall / ceiling light; steel, black / glass painted, white, clear
Wand- / Deckenleuchte; Stahl, schwarz / Glas lackiert, weiss, klar
applique / plafonnier; acier, noir / verre laqué, blanc, clair

H 85, Ø 290



E27

1x 25W



9 002759 831592



Ø 290

83162 PLANET 1

wall / ceiling light; steel, satin nickel / glass painted, white, clear
Wand- / Deckenleuchte; Stahl, nickel-matt / Glas lackiert, weiss, klar
applique / plafonnier; acier, nickel mat / verre laqué, blanc, clair

H 85, Ø 290



E27

1x 25W



9 002759 831622



Ø 290



83162



83163

83163 PLANET 1

wall light; steel, satin nickel / glass painted, white, clear
Wandleuchte; Stahl, nickel-matt / Glas lackiert, weiss, klar
applique; acier, nickel mat / verre laqué, blanc, clair

L 290, H 145, A 85



E27



1x 60W



9 002759 831639





96117

LED



95675

LED



95288

LED

95675 RICONTO 1

wall / ceiling light; steel, white / glass fluted, white, clear
Wand- / Deckenleuchte; Stahl, weiss / Glas geriffelt, weiss, klar
applique / plafonnier; acier, blanc / verre cannelé, blanc, clair

H 70, Ø 250



11W 950lm



9 002759 956752



Ø 250

95288 RICONTO 1

wall / ceiling light; steel, white / glass fluted, white, clear
Wand- / Deckenleuchte; Stahl, weiss / Glas geriffelt, weiss, klar
applique / plafonnier; acier, blanc / verre cannelé, blanc, clair

H 95, Ø 315



11W 950lm



9 002759 952884



Ø 315

96117 MARGITTA 1

wall / ceiling light; steel, white / glass, white, black, clear
Wand- / Deckenleuchte; Stahl, weiss / Glas, weiss, schwarz, klar
applique / plafonnier; acier, blanc / verre, blanc, noir, clair

H 95, Ø 315



11W 950lm



9 002759 961176



Ø 315



96089

LED



96111

LED



96472

LED



96089 MARGITTA 1

wall / ceiling light; steel, white / glass, granille white, clear
Wand- / Deckenleuchte; Stahl, weiss / Glas, granille weiss, klar
applique / plafonnier; acier, blanc / verre, blanc granille, clair

H 70, Ø 250



11W 950lm



9 002759 960896



Ø 250

96111 MARGITTA 1

wall / ceiling light; steel, white / glass, granille white, clear
Wand- / Deckenleuchte; Stahl, weiss / Glas, granille weiss, klar
applique / plafonnier; acier, blanc / verre, blanc granille, clair

H 95, Ø 315



11W 950lm



9 002759 961114



Ø 315

96472 VEREDA

wall / ceiling light; steel, white / glass, granille white, clear
Wand- / Deckenleuchte; Stahl, weiss / Glas, granille weiss, klar
applique / plafonnier; acier, blanc / verre, blanc granille, clair

H 95, Ø 315



11W 950lm



9 002759 964726

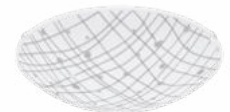

Ø 315



91236



89239



90043

91236 MARS

wall / ceiling light; steel, white / satin glass, white with decor
Wand- / Deckenleuchte; Stahl, weiss / Glas satiniert, weiss m. Dekor
applique / plafonnier; acier, blanc / verre satiné, blanc avec décor

H 70, Ø 250



E27

1x 60W

90043 SCALEA 1

wall / ceiling light; steel, white / satin glass, white with decor
Wand- / Deckenleuchte; Stahl, weiss / Glas satiniert, weiss m. Dekor
applique / plafonnier; acier, blanc / verre satiné, blanc avec décor

H 100, Ø 315



E27

1x 25W

89239 MARS 1

wall / ceiling light; steel, white / satin glass, design "beams"
Wand- / Deckenleuchte; Stahl, weiss / Glas satiniert, Motiv Strahlen
applique / plafonnier; acier, blanc / verre satiné, motif «rayons»

H 70, Ø 250



E27

1x 25W



9 002759 912369



Ø 250



9 002759 900434



Ø 315



9 002759 892395



Ø 250

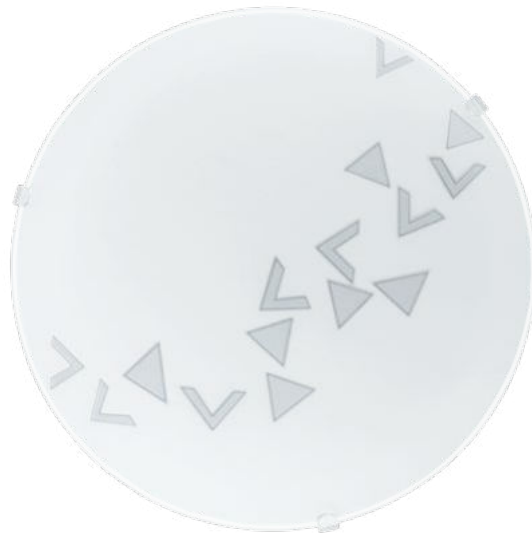

80263



80264



89238

80264 MARS

wall / ceiling light; steel, white / satin glass, design "leaves"
 Wand- / Deckenleuchte; Stahl, weiss / Glas satiniert, Motiv Blätter
 applique / plafonnier; acier, blanc / verre satiné, motif «feuilles»

H 70, Ø 250



E27 1x 25W



9 002759 802646



Ø 250

80263 MARS

wall / ceiling light; steel, white / satin glass, design "triangles"
 Wand- / Deckenleuchte; Stahl, weiss / Glas satiniert, Motiv Dreiecke
 applique / plafonnier; acier, blanc / verre satiné, motif «triangles»

H 70, Ø 250



E27 1x 25W



9 002759 802639



Ø 250

89238 MARS 1

wall / ceiling light; steel, white / satin glass, design "rose"
 Wand- / Deckenleuchte; Stahl, weiss / Glas satiniert, Motiv Rose
 applique / plafonnier; acier, blanc / verre satiné, motif «rose»

H 70, Ø 250



E27 1x 25W



9 002759 892388



Ø 250



95672



DESIGN
HIGHLIGHT
DETAIL



89248

95672 MAGITTA 1

wall / ceiling light; steel, white / glass, white, clear
Wand- / Deckenleuchte; Stahl, weiss / Glas, weiss, klar
applique / plafonnier; acier, blanc / verre, blanc, clair

H 80, Ø 250



11W



950lm



89248 MARS 1

wall / ceiling light; steel, white / satin glass, white, silver
Wand- / Deckenleuchte; Stahl, weiss / Glas satiniert, weiss, silber
applique / plafonnier; acier, blanc / verre satiné, blanc, argent

H 70, Ø 250



E27



1x 25W

89758 RAYA

wall / ceiling light; steel, white, chrome / satin glass, white, silver
Wand- / Deckenleuchte; Stahl, weiss, chrom / Glas satiniert, weiss, silber
applique / plafonnier; acier, blanc, chrome / verre satiné, blanc, argent

H 100, Ø 315



E27



1x 25W



9 002759 956721



Ø 250



9 002759 892487



Ø 250



9 002759 897581



Ø 315



89758



83132



GL-901

84028

83132 GRAFIK

wall / ceiling light; steel / satin glass, design "lines"
Wand- / Deckenleuchte; Stahl / Glas satiniert, Motiv Linien
applique / plafonnier; acier / verre satiné, motif «lignes»

L 180, H 210, A 85



E27

1x 60W



9 002759 831325



L 180

H 210

84028 GRAFIK

wall / ceiling light; steel, silver / satin glass, white
Wand- / Deckenleuchte; Stahl, silber / Glas satiniert, weiss
applique / plafonnier; acier, argent / verre satiné, blanc

L 180, H 210, A 85



E27

1x 60W



9 002759 840280



L 180

H 210

83119 NEMO

wall light; steel, satin nickel / glass opal-matt, white
Wandleuchte; Stahl, nickel-matt / Glas opal-matt, weiss
applique; acier, nickel mat / verre opale mat, blanc

L 150, H 320, A 95



E27

1x 25W



9 002759 831196



L 150

H 320



83119



7186



80265



7184

80265 MARS

wall / ceiling light; steel, white / satin glass, white
Wand- / Deckenleuchte; Stahl, weiss / Glas satiniert, weiss
applique / plafonnier; acier, blanc / verre satiné, blanc

H 70, Ø 250



E27



1x 25W



9 002759 802653



Ø 250

7186 SALOME

wall / ceiling light; steel, chrome / glass alabaster, white
Wand- / Deckenleuchte; Stahl, chrom / Glas alabaster, weiss
applique / plafonnier; acier, chrome / verre albâtre, blanc

H 90, Ø 300



E27



1x 25W



9 002759 718602



Ø 300

7184 SALOME

wall / ceiling light; steel, chrome / glass alabaster, white
Wand- / Deckenleuchte; Stahl, chrom / Glas alabaster, weiss
applique / plafonnier; acier, chrome / verre albâtre, blanc

H 110, Ø 400



E27



2x 25W



9 002759 718404



Ø 400



7188

7188 SALOME

wall light; steel, chrome / glass alabaster, white
Wandleuchte; Stahl, chrom / Glas alabaster, weiss
applique; acier, chrome / verre albâtre, blanc

L 300, H 150, A 90



E27



1x 60W



9 002759 718800



SALOME

These luminaires have a beautiful alabaster glass.

Diese Leuchten besitzen ein wunderschönes Alabasterglas.

Ces luminaires ont un beau verre d'albâtre.





MALVA

This luminaire comes with a hand-made glass with a special wipe technique.

Diese Leuchte besitzt ein handgemachtes Glas mit spezieller Wischtechnik.

Cette luminaire viens avec un verre de luxe faitmain avec un technique à l'essuyé.



90015



86712



82741

90015 MALVA

wall / ceiling light; steel, white / glass wiping technique, beige
Wand- / Deckenleuchte; Stahl, weiss / Glas Wischtechnik, beige
applique / plafonnier; acier, blanc / technique d'essuie de verre, beige

H 95, Ø 315



E27



1x 25W

86712 MESTRE

wall / ceiling light; steel, antique-brown, gold / glass chalked, beige
Wand- / Deckenleuchte; Stahl, antik-braun, gold / Glas gekalkt, beige
applique / plafonnier; acier, marron antique, or / verre chaulé, beige

H 133, Ø 395



E27



2x 60W

82741 IMPERIAL

wall / ceiling light; cast metal, bronzed / satin glass, white
Wand- / Deckenleuchte; Metallguss, brüniert / Glas satiniert, weiss
applique / plafonnier; fonte métallique, bruni / verre satiné, blanc

H 140, Ø 310



E27



2x 25W



9 002759 90015 1



Ø 315



9 002759 86712 6



Ø 395



9 002759 82741 0



Ø 310

H 140



86715



GL1932

89115



87793

89115 ALMERA

wall light; steel, antique-brown / glass, champagne
Wandleuchte; Stahl, antik-braun / Glas, champagner
applique; acier, marron antique / verre, champagne

L 180, H 250, A 75

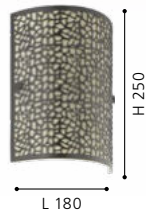

86715 MESTRE

wall light; steel, antique-brown, gold / glass chalked, beige
Wandleuchte; Stahl, antik-braun, gold / Glas gekalkt, beige
applique; acier, marron antique, or / verre chaulé, beige

L 300, H 335, A 160



87793 PASCAL 1

wall light; steel, antique-brown / glass chalked, beige
Wandleuchte; Stahl, antik-braun / Glas gekalkt, beige
applique; acier, marron antique / verre chaulé, beige

L 180, H 480, A 120





90737

90737, 90697

Rustic luminaire series with appealing leaf decor

Rustikale Leuchtenserie mit ansprechendem Blätterdekor

Série de luminaires rustique avec un décor de feuille plaisant



90697

90737 CAMPANIA

ceiling light; steel, antique-brown, gold / glass chalked, white
Deckenleuchte; Stahl, antik-braun, gold / Glas gekalkt, weiss
plafonnier; acier, marron antique, or / verre chaulé, blanc

H 115, Ø 775



G4 15x 10W



9 002759 907372



Ø 775

90697 GERBERA 1

ceiling light; steel, antique-brown, gold / satin glass, white
Deckenleuchte; Stahl, antik-braun, gold / Glas satiniert, weiss
plafonnier; acier, marron antique, or / verre satiné, blanc

H 90, Ø 780



G9 6x 33W



9 002759 906979



Ø 780

92143 COLTI

ceiling light; steel, antique-brown / satin glass, white painted
Deckenleuchte; Stahl, antik-braun / Glas satiniert, weiss lackiert
plafonnier; acier, marron antique / verre satiné, blanc laqué

H 95, Ø 350



E27 2x 25W



9 002759 921439



Ø 350



92143



99349



97886



99348

Matching fabric luminaires can be found from page 100.

Passende Stoffleuchten finden Sie ab Seite 100.

Vous trouverez les luminaires à textile assorties à partir de la page 100.

99349 TABILLANO 1

wall light; steel, black
Wandleuchte; Stahl, schwarz
applique; acier, noir

L 160, H 250, A 500



E27 1x 40W

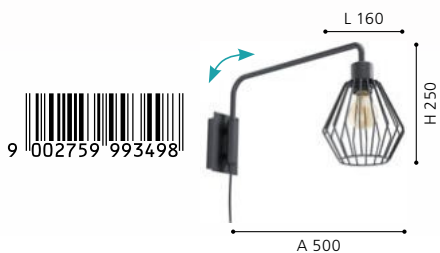

9 002759 993498

97886 SAN PERI

wall light; steel, black
Wandleuchte; Stahl, schwarz
applique; acier, noir

L 130, B 300, H 210



E27 1x 10W

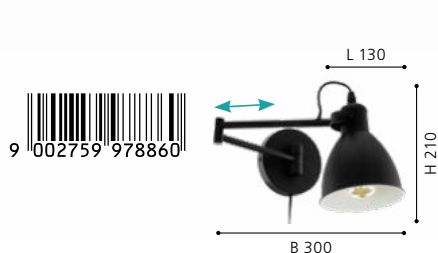

9 002759 978860

99348 STAITI 1

wall light; steel, black / fabric, black
Wandleuchte; Stahl, schwarz / Textil, schwarz
applique; acier, noir / tissu, noir

L 160, H 240, A 500



E27 1x 40W

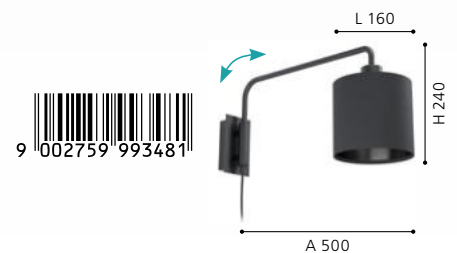

9 002759 993481



99348



99069

LED



99126

LED



GALDAKAO

These luminaires have a shelf.

Diese Leuchten verfügen über eine Ablagefläche.

Ces luminaires ont une étagère.

99069 GALDAKAO

wall light; steel, black / fabric, white
Wandleuchte; Stahl, schwarz / Textil, weiss
applique; acier, noir / tissu, blanc

L 200, H 320, A 125

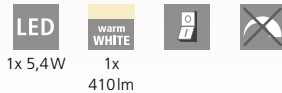

9 002759 990695



99126 GALDAKAO

wall light; steel, wood, black, natural / fabric, white
Wandleuchte; Stahl, Holz, schwarz, natur / Textil, weiss
applique; acier, bois, noir, nature / tissu, blanc

L 200, H 350, A 135, Base: B 200, T 125



9 002759 991265





98263

LED



98265



98265



98263 CIGLIE

wall light; aluminium, steel, black
Wandleuchte; Alu, Stahl, schwarz
applique; aluminium, acier, noir

L 180, H 180, A 210

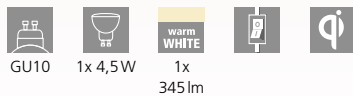

L 180



H 180

A 210



9 002759 982638



98265 CIGLIE

wall light; cast aluminium, black / glass opal-matt, white
Wandleuchte; Aluguss, schwarz / Glas opal-matt, weiss
applique; fonte d'aluminium, noir / verre opale mat, blanc

L 180, H 180, A 210



L 180



H 180

A 210



9 002759 982652



CIGLIE

These luminaires have a Qi charging function. They can wirelessly charge Qi-compatible Smartphones by inductive energy transfer.

Diese Leuchten besitzen eine Qi-Ladefunktion. Damit können Qi-kompatible Smartphones über induktive Energieübertragung kabellos geladen werden.

Ces luminaires disposent d'une fonction de chargement Qi. Cela permet aux smartphones compatibles Qi d'être chargés sans fil par transmission d'énergie inductive.



99595

LED

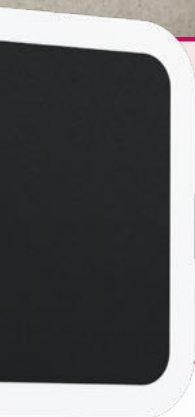

CARTIGNANO

This sleek, modern luminaire is multifunctional, providing illumination and a handy coat rack feature. It can be mounted directly on a wall outlet, and a cord with switch is included in your deliver.

Diese schlichte, moderne Leuchte dient nicht nur als Lichtquelle, sondern auch als Garderobe. Sie kann direkt im Wandauslass montiert werden, ein Kabel mit Schalter wird automatisch mitgeliefert.

Ce luminaire sobre et moderne peuvent non seulement servir de source de lumière, mais aussi de porte-manteau. Les deux lampes peuvent être directement montées sur une prise murale. Le câble avec interrupteur est inclus dans la livraison.

99595 CARTIGNANO

wall light; steel, black / plastic, white
Wandleuchte; Stahl, schwarz / Kunststoff, weiss
applique; acier, noir / plastique, blanc

L 780, H 180, A 35

LED

7,8W

warm
WHITE

920lm





99596



99596 CIVITATE

wall light; steel, wood, black, brown
Wandleuchte; Stahl, Holz, schwarz, braun
applique; acier, bois, noir, marron

L 760, B 100, H 85



18W



1900lm



9 002759 995966



CIVITATE

The CIVITATE LED wall luminaire features a rectangular, black metal body with rounded corners. Five brown, rubber-wood brackets provide space and support for coats and jackets, making this the ideal illuminated coat rack. The CIVITATE emits a warm, comfortable light, providing indirect illumination in your entrance area or foyer. The minimalist design complements a modern interior, and can easily be turned on and off with a switch on the cord.

Die LED Wandleuchte CIVITATE besteht aus einem rechteckigen, schwarzen Metall-Körper mit abgerundeten Ecken. Dank der fünf Halterungen aus braunem Gummibaumholz bietet die Wandlampe genügend Platz für Jacken sowie Mäntel und kann so optimal als beleuchtete Garderobe genutzt werden. Die Leuchte spendet angenehmes warmweißes Licht und schafft so eine indirekte Beleuchtung im Eingangsbereich. Die minimalistische Leuchte rundet moderne Einrichtungsstile ab und ist bequem über einen Schalter am Kabel ein- und ausschaltbar.

L'applique murale LED CIVITATE est composée d'un boîtier rectangulaire en métal noir avec des angles arrondis. Les cinq supports en bois d'hévéa brun permettent d'accrocher des vestes et des manteaux, ce qui permet à l'applique de servir également de porte-manteau. L'applique diffuse une lumière blanc chaud agréable, et ainsi un éclairage indirect pour les entrées. Minimaliste, elle complète des styles intérieurs modernes et peut être facilement actionnée grâce à l'interrupteur situé sur le câble.



TAZZOLI

These luminaires have a USB-connection.

Diese Leuchten verfügen über einen USB-Anschluss.

Ces luminaires disposent d'une connexion USB.

96566 TAZZOLI

wall light; steel, plastic, white
Wandleuchte; Stahl, Kunststoff, weiss
applique; acier, plastique, blanc

L 65, H 300, A 160



96567 TAZZOLI

wall light; steel, plastic, satin nickel, black
Wandleuchte; Stahl, Kunststoff, nickel-matt, schwarz
applique; acier, plastique, nickel mat, noir

L 65, H 300, A 160



99689 GURARE

wall light; steel, schwarz, mokkafarben
Wandleuchte; Stahl, schwarz, mokkafarben
applique; acier, schwarz, mokkafarben

L 125, H 240, A 85

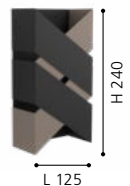
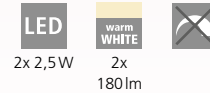

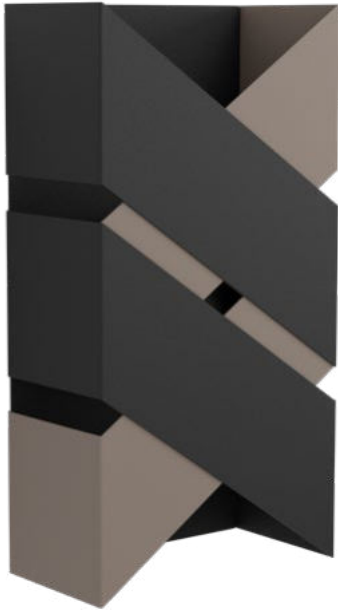

99689

LED



98841

LED

98841 ZINACUA

wall light; steel, silver
Wandleuchte; Stahl, silber
applique; acier, argent

L 225, H 310, A 85



GU10



4x 4,5 W



4x

345 lm



9 002759 988418



INCL.

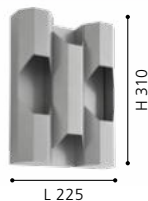



99087

LED



99086

LED

99087 ZUBIALDE

wall light; aluminium, steel, black, white
Wandleuchte; Alu, Stahl, schwarz, weiss
applique; aluminium, acier, noir, blanc

99086 ZUBIALDE

wall light; aluminium, steel, white
Wandleuchte; Alu, Stahl, weiss
applique; aluminium, acier, blanc

ZUBIALDE

The front plate of the luminaire can be swiveled. The light can be adjusted individually.

Die Frontplatte der Leuchte ist schwenkbar. Somit kann das Lichtbild individuell eingestellt werden.

La plaque frontale du luminaire peut être pivotée. La lumière peut être réglée individuellement.

L 360, H 80, A 50

LED
12W

warm
WHITE
1400lm



L 360, H 80, A 50

LED
12W

warm
WHITE
1400lm



9 002759 990879



9 002759 990862





96049



99112



96048



99112 BELATEGI

wall light; steel, black / glass vaporized, black-transparent, clear
Wandleuchte; Stahl, schwarz / Glas bedampft, schwarz-transparent, klar
applique; acier, noir / verre vaporisé, noir transparent, clair

Ø 240, A 180



E27 1x 40W

96049 ONO 2

wall light; aluminium, anthracite / plastic, clear
Wandleuchte; Alu, anthrazit / Kunststoff, klar
applique; aluminium, anthracite / plastique, clair

L 90, H 80, A 130



LED warm WHITE 2x 2,5W 460lm

96048 ONO 2

wall light; aluminium, white / plastic, clear
Wandleuchte; Alu, weiss / Kunststoff, klar
applique; aluminium, blanc / plastique, clair

L 90, H 80, A 130



LED warm WHITE 2x 2,5W 460lm



9 002759 991128



Ø 240



9 002759 960490



A 130

H 80



9 002759 960483



A 130

H 80



98542



98541



98543



98541 MACCARI

wall light; aluminium, steel, white / plastic, transparent
Wandleuchte; Alu, Stahl, weiss / Kunststoff, transparent
applique; aluminium, acier, blanc / plastique, transparent

L 270, H 75, A 130



10W 1100lm



9 002759 985417



L 270

98542 MACCARI

wall light; aluminium, steel, black, gold / plastic, transparent
Wandleuchte; Alu, Stahl, schwarz, gold / Kunststoff, transparent
applique; aluminium, acier, noir, or / plastique, transparent

L 270, H 75, A 130



10W 1100lm



9 002759 985424



L 270

98543 MACCARI

wall light; aluminium, steel, white, satin nickel / plastic, transparent
Wandleuchte; Alu, Stahl, weiss, nickel-matt / Kunststoff, transparent
applique; aluminium, acier, blanc, nickel mat / plastique, transparent

L 270, H 75, A 130



10W 1100lm



9 002759 985431

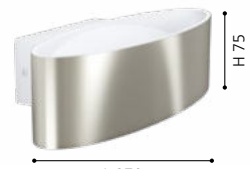

L 270



98544



98545



98544 FELONICHE

wall light; aluminium, white / plastic, transparent
 Wandleuchte; Alu, weiss / Kunststoff, transparent
 applique; aluminium, blanc / plastique, transparent

L 220, H 100, A 75



10W 1100lm

98545 FELONICHE

wall light; aluminium, black, gold / plastic, transparent
 Wandleuchte; Alu, schwarz, gold / Kunststoff, transparent
 applique; aluminium, noir, or / plastique, transparent

L 220, H 100, A 75



10W 1100lm



9 002759 985448



9 002759 985455

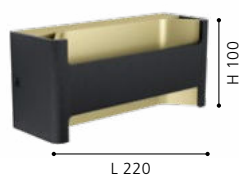



98421



98422



98423



98421 SANIA 4

wall light; aluminium, white
Wandleuchte; Alu, weiss
applique; aluminium, blanc

L 130, H 80, A 90



6W

600lm

98422 SANIA 4

wall light; aluminium, white
Wandleuchte; Alu, weiss
applique; aluminium, blanc

L 200, H 80, A 90



10W

1100lm

98423 SANIA 4

wall light; aluminium, white
Wandleuchte; Alu, weiss
applique; aluminium, blanc

L 365, H 80, A 90



12W

1400lm



9 002759 984212

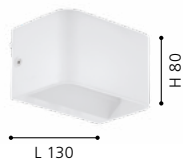

9 002759 984229

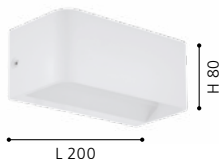

9 002759 984236

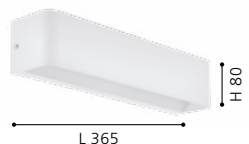



98424



98425



98426



98424 SANIA 4

wall light; aluminium, satin nickel
Wandleuchte; Alu, nickel-matt
applique; aluminium, nickel mat

L 130, H 80, A 90



6 W 600lm



9 002759 984243

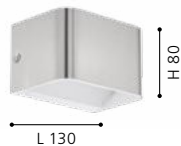

98425 SANIA 4

wall light; aluminium, satin nickel
Wandleuchte; Alu, nickel-matt
applique; aluminium, nickel mat

L 200, H 80, A 90



10 W 1100lm



9 002759 984250

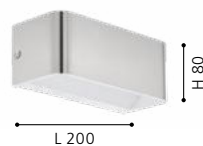

98426 SANIA 4

wall light; aluminium, satin nickel
Wandleuchte; Alu, nickel-matt
applique; aluminium, nickel mat

L 365, H 80, A 90



12 W 1400lm



9 002759 984267

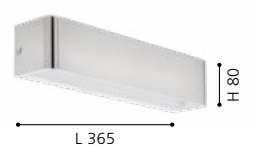



96261

LED



96261 PASSA

wall light; steel, satin nickel, chrome
Wandleuchte; Stahl, nickel-matt, chrom
applique; acier, nickel mat, chrome

L 60, H 170, A 85



GU10



2x 3W



warm
WHITE

2x

250lm



9 002759 962616



INCL.





96264

LED



95368

LED



95377

LED

96264 PASSA

wall light; steel, satin nickel, chrome
Wandleuchte; Stahl, nickel-matt, chrom
applique; acier, nickel mat, chrome

L 55, H 170, A 85

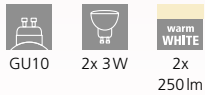

95368 PASSA

wall light; steel, chrome, white
Wandleuchte; Stahl, chrom, weiss
applique; acier, chrome, blanc

L 60, H 170, A 85

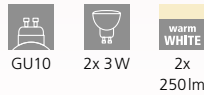

95377 PASSA

wall light; steel, chrome, white
Wandleuchte; Stahl, chrom, weiss
applique; acier, chrome, blanc

L 55, H 170, A 85





95371

LED



95379

LED

95371 PASSA

wall light; steel, brown, copper
Wandleuchte; Stahl, braun, kupfer
applique; acier, marron, cuivre

L 60, H 170, A 85



9 002759 953713

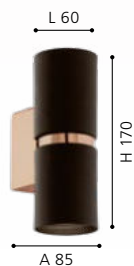

95379 PASSA

wall light; steel, brown, copper
Wandleuchte; Stahl, braun, kupfer
applique; acier, marron, cuivre

L 55, H 170, A 85



9 002759 953799



95364 PASSA

wall light; steel, black, gold
Wandleuchte; Stahl, schwarz, gold
applique; acier, noir, or

L 60, H 170, A 85



9 002759 953645

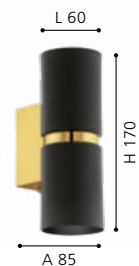



95364

LED



95373

LED

95373 PASSA

wall light; steel, black, gold
Wandleuchte; Stahl, schwarz, gold
applique; acier, noir, or

L 55, H 170, A 85



GU10



2x 3W



warm
WHITE
2x
250lm



9 002759 953737

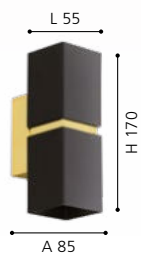



98379



98755

98379 GASCUERIA

wall light; plastic, steel, gold, black
Wandleuchte; Kunststoff, Stahl, gold, schwarz
applique; plastique, acier, or, noir

L 290, H 330, A 130



E27 1x 60W



9 002759 983796

98755 ELIZONDO

wall light; steel, black, gold
Wandleuchte; Stahl, schwarz, gold
applique; acier, noir, or

L 80, H 270, A 115



E14 1x 40W



9 002759 987558

98759 FALICETTO

wall light; steel, black, gold
Wandleuchte; Stahl, schwarz, gold
applique; acier, noir, or

L 160, H 250, A 115



E27 1x 40W

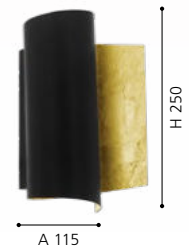

9 002759 987596



98759





98656



98655



98657



98656 MONGODIO 1

wall / ceiling light; steel, white / plastic, white
Wand- / Deckenleuchte; Stahl, weiss / Kunststoff, weiss
applique / plafonnier; acier, blanc / plastique, blanc

H 35, Ø 200



8,6W 920lm



9 002759 986568



Ø 200

98655 MONGODIO 1

wall / ceiling light; steel, white / plastic, white
Wand- / Deckenleuchte; Stahl, weiss / Kunststoff, weiss
applique / plafonnier; acier, blanc / plastique, blanc

H 35, Ø 140



5,4W 570lm



9 002759 986551



Ø 140

98657 MONGODIO 1

wall / ceiling light; steel, white / plastic, white
Wand- / Deckenleuchte; Stahl, weiss / Kunststoff, weiss
applique / plafonnier; acier, blanc / plastique, blanc

H 35, Ø 250



11,4W 1240lm



9 002759 986575



Ø 250



98676

LED



98676 ELGVERO

wall / ceiling light; steel, white / plastic, white
 Wand- / Deckenleuchte; Stahl, weiss / Kunststoff, weiss
 applique / plafonnier; acier, blanc / plastique, blanc

H 100, Ø 250

LED	warm WHITE	LED	warm WHITE	LED
5,4W	570lm	8,6W	920lm	11.4W

warm WHITE		
1240lm		



98676

By turning you can adjust the luminaire individually.

Durch drehen kann man die Leuchte individuell einstellen.

En tournant, vous pouvez régler la lampe individuellement.



30658



30659



33941



30658 CADEGAL

ceiling light; steel, black / plastic, white
Deckenleuchte; Stahl, schwarz / Kunststoff, weiss
plafonnier; acier, noir / plastique, blanc

L 200, B 200, H 50



9W

1214lm

30659 CADEGAL

ceiling light; steel, black / plastic, white
Deckenleuchte; Stahl, schwarz / Kunststoff, weiss
plafonnier; acier, noir / plastique, blanc

H 50, Ø 200



9W

1192lm

33941 CADEGAL

ceiling light; steel, white / plastic, white
Deckenleuchte; Stahl, weiss / Kunststoff, weiss
plafonnier; acier, blanc / plastique, blanc

L 200, B 200, H 50



9W

1214lm



9 002759 306588

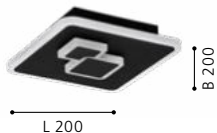

9 002759 306595

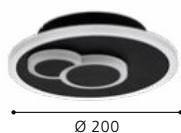

9 002759 339418





33942

LED



33964

LED

33942 CADEGAL

ceiling light; steel, white / plastic, white
Deckenleuchte; Stahl, weiss / Kunststoff, weiss
plafonnier; acier, blanc / plastique, blanc

H 50, Ø 200



9W 1192lm



9 002759 339425



Ø 200

33964 REMIDOS

ceiling light; steel, white / plastic, white
Deckenleuchte; Stahl, weiss / Kunststoff, weiss
plafonnier; acier, blanc / plastique, blanc

H 90, Ø 400



15W 2250lm 4W 650lm



9 002759 339647



Ø 400



98888

LED



96038

LED



96037

LED

98888 METRASS

wall light; aluminium, black / plastic, satined
Wandleuchte; Alu, schwarz / Kunststoff, satiniert
applique; aluminium, noir / plastique, satiné

L 200, H 105, A 60



1x 5,6W
1x 680lm



9 002759 988883



96037 METRASS

wall light; aluminium, white / plastic, satined
Wandleuchte; Alu, weiss / Kunststoff, satiniert
applique; aluminium, blanc / plastique, satiné

L 200, H 105, A 60



1x 5,6W
1x 680lm



9 002759 960377



96038 METRASS

wall light; aluminium, satin nickel / plastic, satined
Wandleuchte; Alu, nickel-matt / Kunststoff, satiniert
applique; aluminium, nickel mat / plastique, satiné

L 200, H 105, A 60



1x 5,6W
1x 680lm



9 002759 960384





96042



96043



96042 METRASS 2

wall / ceiling light; aluminium, white / plastic, satined
 Wand- / Deckenleuchte; Alu, weiss / Kunststoff, satiniert
 applique / plafonnier; aluminium, blanc / plastique, satiné

L 170, H 200, A 55



96043 METRASS 2

wall / ceiling light; aluminium, satin nickel / plastic, satined
 Wand- / Deckenleuchte; Alu, nickel-matt / Kunststoff, satiniert
 applique / plafonnier; aluminium, nickel mat / plastique, satiné

L 170, H 200, A 55

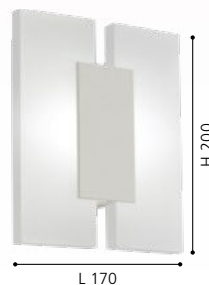



96039

LED



96041

LED

96039 METRASS 1

wall light; aluminium, white / plastic, satiné
Wandleuchte; Alu, weiss / Kunststoff, satiniert
applique; aluminium, blanc / plastique, satiné

L 130, H 130, A 50

LED

1x 4,5W

warm
WHITE

1x
480lm



9 002759 960391

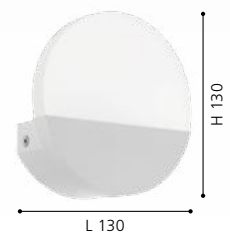



96002



95774



96041 METRASS 1

wall light; aluminium, satin nickel / plastic, satiné
Wandleuchte; Alu, nickel-matt / Kunststoff, satiniert
applique; aluminium, nickel mat / plastique, satiné

L 130, H 130, A 50



1x 4,5W
1x 480lm



9 002759 960414

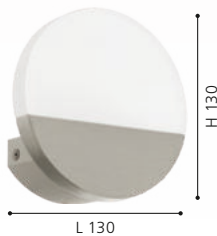

96002 PEDRISTELLA

wall / ceiling light; steel, satin nickel / satin glass, white
Wand- / Deckenleuchte; Stahl, nickel-matt / Glas satiniert, weiss
applique / plafonnier; acier, nickel mat / verre satiné, blanc

H 80, Ø 130



6W
500lm



9 002759 960025



95774 CUPELLA

wall light; steel, satin nickel / plastic, white
Wandleuchte; Stahl, nickel-matt / Kunststoff, weiss
applique; acier, nickel mat / plastique, blanc

L 110, H 180, A 65



2x 4,5W
2x 480lm



9 002759 957742





95768



99606



99607



95768 LASANA

wall light; steel, aluminium, chrome / plastic, white
Wandleuchte; Stahl, Alu, chrom / Kunststoff, weiss
applique; acier, aluminium, chrome / plastique, blanc

L 180, H 195, A 60



5,5W 550lm



9 002759 957681



99606 SARGINTO

wall / ceiling light; steel, white / plastic, white
Wand- / Deckenleuchte; Stahl, weiss / Kunststoff, weiss
applique / plafonnier; acier, blanc / plastique, blanc

L 590, B 140, H 45

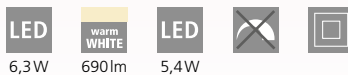

6,3W 690lm 5,4W



9 002759 996062



99607 SARGINTO

wall / ceiling light; steel, white / plastic, white
Wand- / Deckenleuchte; Stahl, weiss / Kunststoff, weiss
applique / plafonnier; acier, blanc / plastique, blanc

L 590, B 130, H 45



6,3W 690lm 5,4W



9 002759 996079





99609



99608



99609 SARGINTO

wall / ceiling light; steel, black / plastic, white
 Wand- / Deckenleuchte; Stahl, schwarz / Kunststoff, weiss
 applique / plafonnier; acier, noir / plastique, blanc

L 590, B 130, H 45



6,3W 690lm 5,4W



9 002759 996093



99608 SARGINTO

wall / ceiling light; steel, black / plastic, white
 Wand- / Deckenleuchte; Stahl, schwarz / Kunststoff, weiss
 applique / plafonnier; acier, noir / plastique, blanc

L 590, B 140, H 45



6,3W 690lm 5,4W



9 002759 996086

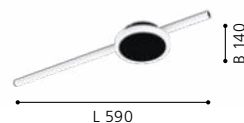

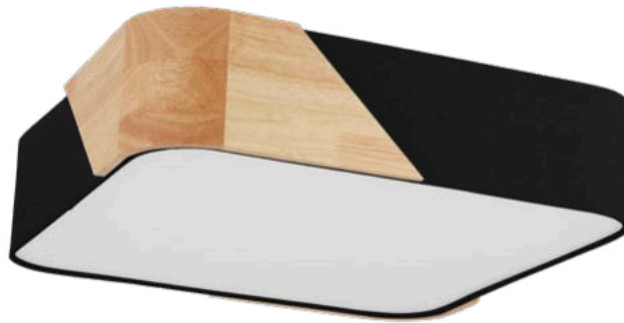

99389



99388



99458

99388 GRIMALDINO

ceiling light; fabric, wood, steel, black, brown / plastic, white
 Deckenleuchte; Textil, Holz, Stahl, schwarz, braun / Kunststoff, weiss
 plafonnier; tissu, bois, acier, noir, marron / plastique, blanc

H 125, Ø 400



99389 GRIMALDINO

ceiling light; fabric, wood, steel, black, brown / plastic, white
 Deckenleuchte; Textil, Holz, Stahl, schwarz, braun / Kunststoff, weiss
 plafonnier; tissu, bois, acier, noir, marron / plastique, blanc

L 415, B 415, H 125



99458 GRIMALDINO

ceiling light; fabric, wood, steel, white, brown / plastic, white
 Deckenleuchte; Textil, Holz, Stahl, weiss, braun / Kunststoff, weiss
 plafonnier; tissu, bois, acier, blanc, marron / plastique, blanc

H 125, Ø 400



9 002759 993887

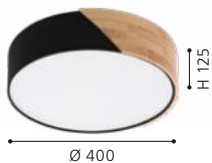

9 002759 993894

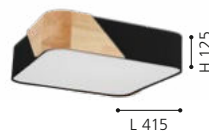

9 002759 994587

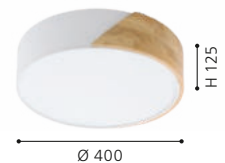



99459 GRIMALDINO

ceiling light; fabric, wood, steel, white, brown / plastic, white
 Deckenleuchte; Textil, Holz, Stahl, weiss, braun / Kunststoff, weiss
 plafonnier; tissu, bois, acier, blanc, marron / plastique, blanc

L 415, B 415, H 125

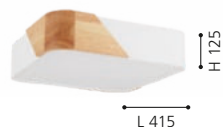

99461 GRIMALDINO

ceiling light; fabric, wood, steel, taupe, brown / plastic, white
 Deckenleuchte; Textil, Holz, Stahl, taupe, braun / Kunststoff, weiss
 plafonnier; tissu, bois, acier, taupe, marron / plastique, blanc

H 125, Ø 400

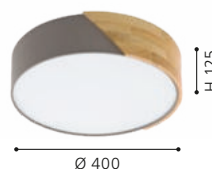

99462 GRIMALDINO

ceiling light; fabric, wood, steel, taupe, brown / plastic, white
 Deckenleuchte; Textil, Holz, Stahl, taupe, braun / Kunststoff, weiss
 plafonnier; tissu, bois, acier, taupe, marron / plastique, blanc

L 415, B 415, H 125

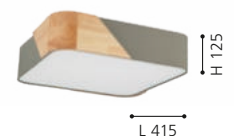

BATH & MIRROR LUMINAIRES

BAD- & SPIEGELLEUCHTEN
LUMINAIRES DE BAIN & MIROIR

PURE RELAXATION -

Turn your bathroom into your personal wellness oasis. Trendy bathroom and mirror luminaires give a pleasant light and ensure relaxation and comfort.

ENTSPANNUNG PUR -

Verwandeln Sie Ihr Badezimmer in eine persönliche Wohlfühloase. Trendige Bad- und Spiegelleuchten spenden ein angenehmes Licht und sorgen für Entspannung und Ihr Wohlbefinden.

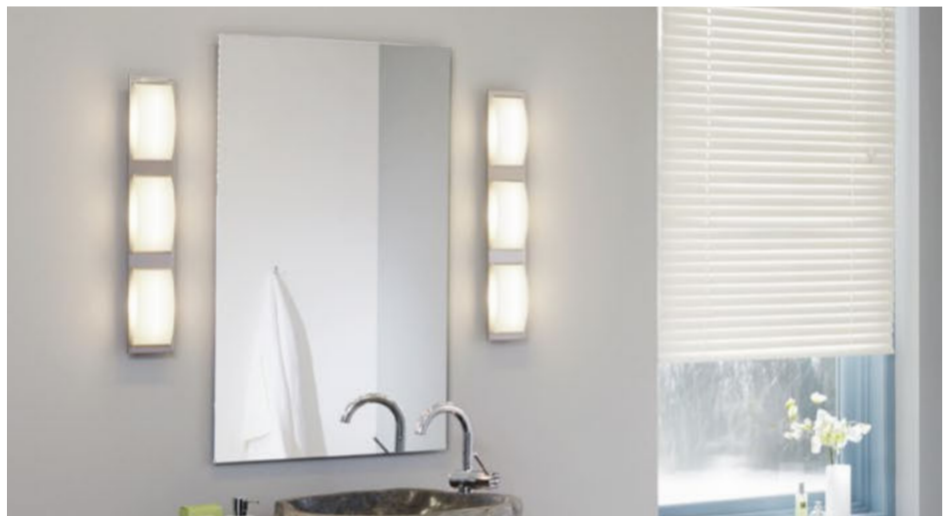

DE LA PURE DÉTENTE -

Transformez votre salle de bains en un îlot personnel de bien-être. Des éclairages à la mode de miroirs et de bain confèrent une lumière agréable et vous assurent de la détente et du bien-être.



OVERVIEW

BATH & MIRROR LUMINAIRES



AMEZOLA
p. 558



TAMARA 1
p. 560-561



ALMONTE
p. 562



TOLORICO
p. 564



MOSIANO
p. 566



PALMITAL
p. 566



WASAO 1
p. 568-569



BARI-M
p. 570



FRANIA
p. 570-571



MANILVA 1
p. 571



LED PALERMO
p. 573



LED LORA
p. 573



LED CARPI
p. 574-575



FUEVA 5
p. 576-578



ROMENDO 1
p. 580-581



CABUS
p. 582



SIDERNO
p. 584



SANIA 5
p. 584-585



TRAGACETE 1
p. 586-587



GITA 2
p. 588



CALNOVA
p. 590



TORRETTA
p. 591



TABIANO
p. 593



VADUMI
p. 594



PANDELLA 1
p. 596-599



PANDELLA 2
p. 596, 600



VINCHIO
p. 600



PALMERA
p. 602



CAILIN
p. 602



STICKER
p. 603



ZOLA
p. 604



MONO
p. 604-605



BARI 1
p. 605



FUEVA 5
p. 606-611



BUENAVISTA
p. 612



BUENAVISTA 1
p. 614



BUENAVISTA 2
p. 614-615



TABIANO-Z
p. 29



JUAREZA-Z
p. 29



FUEVA-Z
p. 48-59

You can also find bathroom and mirror lights in EGLO connect.Z.

Bad und Spiegelleuchten finden sie auch in EGLO connect.Z.

Vous pouvez également trouver des lampes de salle de bain et de miroir dans EGLO connect.Z.



This product is available in different colors and shapes./ Dieser Artikel ist in unterschiedlichen Farben und Formen verfügbar.
Cet article est disponible en différentes couleurs et formes.

COLOUR RENDERING INDEX

FARBWIEDERGABE-INDEX

L'INDICE DE RESTITUTION DE COULEURS

QUALITY CRITERION COLOUR RENDERING The colour rendering index Ra describes the colour rendering quality of lamps. The higher the Ra value, the less will the artificial light change the colour of an object. The maximum Ra value (e.g. the Ra value of the sun) is 100.

Therefore, lamps with an Ra above 90 will make you look better.

Lamps with an Ra value above 90 are marked with this button: 



QUALITÄTSKRITERIUM FARBWIEDERGABE Mit dem Farbwiedergabe-Index Ra wird die Qualität der Farbwiedergabe von Leuchten beschrieben. Je höher der Ra-Wert ist, desto weniger verfälscht das künstliche Licht die Farbe von Objekten. Der maximale Ra-Wert (z.B. der Ra-Wert der Sonne) ist 100.

Leuchten mit Ra >90 lassen Sie somit besser aussehen.

Leuchten die einen Ra-Wert von >90 haben, sind mit diesem Button gekennzeichnet: 



CRITÈRE DE QUALITÉ INDIQUANT LA RESTITUTION DES COULEURS L'indice de restitution de couleurs Ra décrit la qualité de restitution des éclairages. Plus la valeur Ra est élevée, moins la lumière artificielle falsifie la couleur des objets. La valeur Ra maximale (par ex. la valeur Ra du soleil) est 100.

Ainsi, favorisez des lampes avec une valeur Ra > 90.

Les lampes ayant une valeur Ra > 90 sont identifiées par ce bouton: 



99122



99122 | 99123 | 99124



99124

99122 AMEZOLA

wall / ceiling light; steel, black / glass, clear
Wand- / Deckenleuchte; Stahl, schwarz / Glas, klar
applique / plafonnier; acier, noir / verre, clair

L 290, H 290, A 130



E27

2x 40W

IP44



9 002759 991227



L 290

99124 AMEZOLA

wall light; steel, black / glass, clear
Wandleuchte; Stahl, schwarz / Glas, klar
applique; acier, noir / verre, clair

L 110, H 380, A 100



E27

1x 60W

IP44



9 002759 991241



A 100

99123 AMEZOLA

wall light; steel, black / glass, clear
Wandleuchte; Stahl, schwarz / Glas, klar
applique; acier, noir / verre, clair

L 110, H 260, A 100



E27

1x 60W

IP44



9 002759 991234



A 100



99123





95994



95993



95995



95993 TAMARA 1

spot; steel, glass, white, chrome
Spot; Stahl, Glas, weiss, chrom
spot; acier, verre, blanc, chrome

L 120, B 120

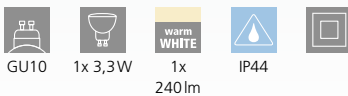

GU10 1x 3,3W 1x 240lm IP44



L 120

95994 TAMARA 1

spot; steel, glass, white, chrome
Spot; Stahl, Glas, weiss, chrom
spot; acier, verre, blanc, chrome

L 460, B 70

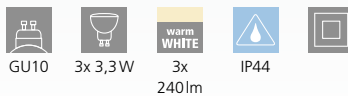

GU10 3x 3,3W 3x 240lm IP44



L 460

95995 TAMARA 1

spot; steel, glass, white, chrome
Spot; Stahl, Glas, weiss, chrom
spot; acier, verre, blanc, chrome

L 240, B 260

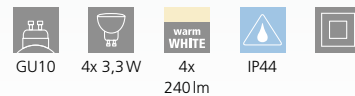

GU10 4x 3,3W 4x 240lm IP44



L 240



33678

LED

DESIGN
HIGHLIGHT
DETAIL



33677

LED



33677 TAMARA 1

spot; steel, black, chrome / glass, clear
Spot; Stahl, schwarz, chrom / Glas, klar
spot; acier, noir, chrome / verre, clair

L 120, B 120

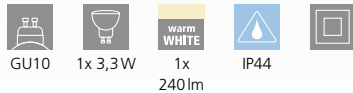

GU10 1x 3,3W 1x warm WHITE IP44



L 120

33678 TAMARA 1

spot; steel, black, chrome / glass, clear
Spot; Stahl, schwarz, chrom / Glas, klar
spot; acier, noir, chrome / verre, clair

L 240, B 260

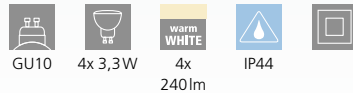

GU10 4x 3,3W 4x warm WHITE IP44



L 240

B 260

DESIGN
HIGHLIGHT
DETAIL



94879

LED



97699

LED

94879 ALMONTE

wall light; steel, chrome / crystal, clear
Wandleuchte; Stahl, chrom / Kristall, klar
applique; acier, chrome / cristal, clair

L 110, H 230, A 170



G9



1x 3W



warm
WHITE

1x 360lm



IP44



9 002759 948795



97699 ALMONTE

ceiling light; steel, chrome / crystal, clear
Deckenleuchte; Stahl, chrom / Kristall, klar
plafonnier; acier, chrome / cristal, clair

H 300, Ø 500



G9



8x 3W



warm
WHITE

8x 360lm



IP44



9 002759 976996



94878 ALMONTE

ceiling light; steel, chrome / crystal, clear
Deckenleuchte; Stahl, chrom / Kristall, klar
plafonnier; acier, chrome / cristal, clair

H 230, Ø 350



G9



4x 3W



warm
WHITE

4x 360lm



IP44



9 002759 948788

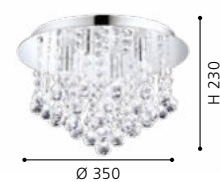



94878

LED





TOLORICO

These luminaires come with high quality glass crystals.

Diese Leuchten sind mit hochwertigen Glaskristallen ausgestattet.

Ces luminaires viennent avec des cristaux de verre de haute qualité.



97055

LED

97054

LED

97054 TOLORICO

wall / ceiling light; stainless steel, chrome / plastic, crystal, clear
Wand- / Deckenleuchte; Edelstahl, chrom / Kunststoff, Kristall, klar

applique / plafonnier; acier inoxydable, chrome / plastique, cristal, clair

L 350, B 100, H 70



8W

1100lm

IP44

97055 TOLORICO

wall / ceiling light; stainless steel, chrome / plastic, crystal, clear
Wand- / Deckenleuchte; Edelstahl, chrom / Kunststoff, Kristall, klar

applique / plafonnier; acier inoxydable, chrome / plastique, cristal, clair

L 570, B 100, H 75



19W

2500lm

IP44

97056 TOLORICO

wall / ceiling light; stainless steel, chrome / plastic, crystal, clear
Wand- / Deckenleuchte; Edelstahl, chrom / Kunststoff, Kristall, klar

applique / plafonnier; acier inoxydable, chrome / plastique, cristal, clair

L 350, B 350, H 75



3x 7W

3x
1000lm

IP44



9 002759 970543



L 350

B 100



9 002759 970550



L 570

B 100



9 002759 970567



L 350

B 350



97056

LED



94626

LED



97966

LED

94626 MOSIANO

wall / ceiling light; stainless steel, chrome / glass opal-matt, white
Wand- / Deckenleuchte; Edelstahl, chrom / Glas opal-matt, weiss
applique / plafonnier; acier inoxydable, chrome / verre opale mat, blanc

H 115, Ø 110



1x 3,3W
1x
340lm

97966 PALMITAL

wall light; aluminium, steel, chrome / plastic, clear
Wandleuchte; Alu, Stahl, chrom / Kunststoff, klar
applique; aluminium, acier, chrome / plastique, clair

L 595, H 80, A 65



1x 10W
1x
1300lm

97965 PALMITAL

wall / ceiling light; aluminium, steel, chrome / plastic, clear
Wand- / Deckenleuchte; Alu, Stahl, chrom / Kunststoff, klar
applique / plafonnier; aluminium, acier, chrome / plastique, clair

L 880, B 100, H 90



2x 10W
2x
1300lm



9 002759 946265



9 002759 979669



9 002759 979652





97965

LED





94882

LED



94881

LED



94884

LED

94881 WASAO 1

wall / ceiling light; stainless steel, chrome / glass painted, white
Wand- / Deckenleuchte; Edelstahl, chrom / Glas lackiert, weiss
applique / plafonnier; acier inoxydable, chrome / verre laqué, blanc

L 210, B 105, A 60



1x 5,4W

510lm

IP44

94882 WASAO 1

wall / ceiling light; stainless steel, chrome / glass painted, white
Wand- / Deckenleuchte; Edelstahl, chrom / Glas lackiert, weiss
applique / plafonnier; acier inoxydable, chrome / verre laqué, blanc

L 420, B 105, H 60



2x 5,4W

2x
510lm

IP44



94884 WASAO 1

wall / ceiling light; stainless steel, chrome / glass painted, white
Wand- / Deckenleuchte; Edelstahl, chrom / Glas lackiert, weiss
applique / plafonnier; acier inoxydable, chrome / verre laqué, blanc

L 320, B 320, H 60



4x 5,4W

4x
510lm

IP44



9 002759 948818



L 210

B 105



9 002759 948825



L 420

B 105



9 002759 948849



L 320

B 320

94883 WASAO 1

wall / ceiling light; stainless steel, chrome / glass painted, white
Wand- / Deckenleuchte; Edelstahl, chrom / Glas lackiert, weiss
applique / plafonnier; acier inoxydable, chrome / verre laqué,
blanc

L 630, B 105, H 60

LED
3x 5,4W

**warm
WHITE**
3x
510lm

  
IP44



94883





97531



97531



97884

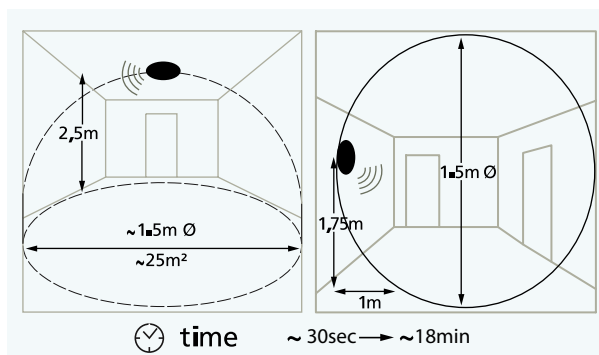

97531

This luminaire comes with an integrated motion sensor.
The sensor is mounted invisibly behind the glass.

Diese Leuchte ist mit einem integrierten Bewegungssensor ausgestattet.
Der Sensor ist unsichtbar hinter dem Glas befestigt.

Ce luminaire vient avec un capteur de mouvement intégré.
Le capteur est attaché invisiblement derrière le verre.

97531 BARI-M

ceiling light; plastic, white / glass, white
Deckenleuchte; Kunststoff, weiss / Glas, weiss
plafonnier; plastique, blanc / verre, blanc

H 110, Ø 275



E27



1x 20W



IP44



97884 FRANIA

wall / ceiling light; steel, white / plastic, white
Wand- / Deckenleuchte; Stahl, weiss / Kunststoff, weiss
applique / plafonnier; acier, blanc / plastique, blanc

H 70, Ø 330



17,3W



2000lm



IP44



9 002759 975319



Ø 275



9 002759 978846



Ø 330



96231

LED



96229

LED



97885

LED



97885 FRANIA

wall / ceiling light; steel, white / plastic, white
Wand- / Deckenleuchte; Stahl, weiss / Kunststoff, weiss
applique / plafonnier; acier, blanc / plastique, blanc

L 330, B 330, H 70



17,3W 2000lm

96231 MANILVA 1

wall light; steel, satin nickel / plastic, white
Wandleuchte; Stahl, nickel-matt / Kunststoff, weiss
applique; acier, nickel mat / plastique, blanc

L 290, B 290, H 70



16W 1500lm

96229 MANILVA 1

wall light; steel, chrome / plastic, white
Wandleuchte; Stahl, chrom / Kunststoff, weiss
applique; acier, chrome / plastique, blanc

L 290, B 290, H 70



16W 1500lm



9 002759 978853



L 330

B 330



9 002759 962319



L 290

B 290



9 002759 962296



L 290

B 290



94999

LED



94998

LED



95001

LED

94999 LED PALERMO

wall / ceiling light; steel, chrome / satin glass, white painted
Wand- / Deckenleuchte; Stahl, chrom / Glas satiniert, weiss lackiert
applique / plafonnier; acier, chrome / verre satiné, blanc laqué

Ø 295, A 77



94998 LED PALERMO

wall / ceiling light; steel, chrome / satin glass, white painted
Wand- / Deckenleuchte; Stahl, chrom / Glas satiniert, weiss lackiert
applique / plafonnier; acier, chrome / verre satiné, blanc laqué

Ø 225, A 60



95001 LED LORA

ceiling light; steel, chrome / glass opal-matt, white
Deckenleuchte; Stahl, chrom / Glas opal-matt, weiss
plafonnier; acier, chrome / verre opale mat, blanc

Ø 320, A 70



9 002759 949990



Ø 295



9 002759 949983



Ø 225



9 002759 950019



Ø 320

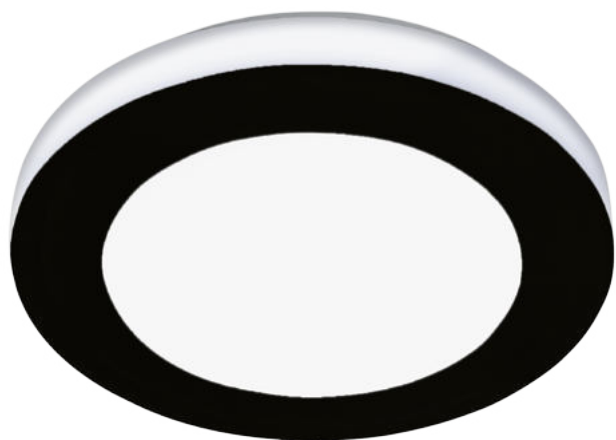

33682



94967



95282



33682 LED CARPI

wall / ceiling light; steel, black, white / plastic, white
Wand- / Deckenleuchte; Stahl, schwarz, weiss / Kunststoff, weiss
applique / plafonnier; acier, noir, blanc / plastique, blanc

Ø 300, A 75



95282 LED CARPI

wall / ceiling light; steel, white, chrome / plastic, white
Wand- / Deckenleuchte; Stahl, weiss, chrom / Kunststoff, weiss
applique / plafonnier; acier, blanc, chrome / plastique, blanc

Ø 300, A 75



94967 LED CARPI

wall / ceiling light; steel, aluminium, white, brushed aluminium / plastic, white
Wand- / Deckenleuchte; Stahl, Alu, weiss, alu-gebürstet / Kunststoff, weiss
applique / plafonnier; acier, aluminium, blanc, aluminium brossé / plastique, blanc
Ø 300, A 75



9 002759 336820



Ø 300



9 002759 952822



Ø 300



9 002759 949679



Ø 300



95283

LED



95283 LED CARPI

wall / ceiling light; steel, white, chrome / plastic, white
Wand- / Deckenleuchte; Stahl, weiss, chrom / Kunststoff, weiss
applique / plafonnier; acier, blanc, chrome / plastique, blanc

Ø 385, A 75

LED

16W

warm
WHITE

1500lm



IP44



9 002759 952839



Ø 385





99265



99267



99265 FUEVA 5

surface-mounted light; steel, white / plastic, white
Aufbauleuchte; Stahl, weiss / Kunststoff, weiss
luminaire en saillie; acier, blanc / plastique, blanc

H 28, Ø 285



99267 FUEVA 5

surface-mounted light; steel, black / plastic, white
Aufbauleuchte; Stahl, schwarz / Kunststoff, weiss
luminaire en saillie; acier, noir / plastique, blanc

H 28, Ø 285



99266 FUEVA 5

surface-mounted light; steel, chrome / plastic, white
Aufbauleuchte; Stahl, chrom / Kunststoff, weiss
luminaire en saillie; acier, chrome / plastique, blanc

H 28, Ø 285



Ø 285



Ø 285



Ø 285



99266

LED





99268



99271



99268 FUEVA 5

surface-mounted light; steel, white / plastic, white
 Aufbauleuchte; Stahl, weiss / Kunststoff, weiss
 luminaire en saillie; acier, blanc / plastique, blanc

L 285, B 285, H 30



99271 FUEVA 5

surface-mounted light; steel, black / plastic, white
 Aufbauleuchte; Stahl, schwarz / Kunststoff, weiss
 luminaire en saillie; acier, noir / plastique, blanc

L 285, B 285, H 30



99269 FUEVA 5

surface-mounted light; steel, chrome / plastic, white
 Aufbauleuchte; Stahl, chrom / Kunststoff, weiss
 luminaire en saillie; acier, chrome / plastique, blanc

L 285, B 285, H 30

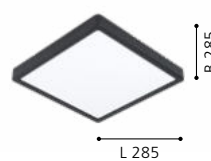



99269

LED





96541 ROMENDO 1

wall light; steel, chrome / plastic, clear, satiné
Wandleuchte; Stahl, chrom / Kunststoff, klar, satiniert
applique; acier, chrome / plastique, clair, satiné

L 70, H 155, A 120

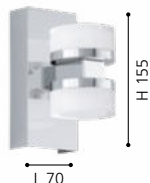
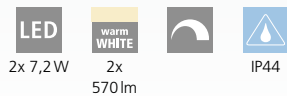

96542 ROMENDO 1

wall light; steel, chrome / plastic, clear, satiné
Wandleuchte; Stahl, chrom / Kunststoff, klar, satiniert
applique; acier, chrome / plastique, clair, satiné

L 300, H 70, A 125

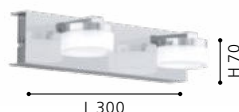
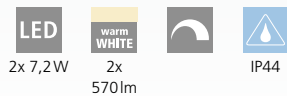

96544 ROMENDO 1

ceiling light; steel, chrome / plastic, clear, satiné
Deckenleuchte; Stahl, chrom / Kunststoff, klar, satiniert
plafonnier; acier, chrome / plastique, clair, satiné

L 320, B 320, H 70





ROMENDO 1

These luminaires are dimmable.

Diese Leuchten sind dimmbar.

Ces luminaires sont graduables.

96543 ROMENDO 1

wall light; steel, chrome / plastic, clear, satined
Wandleuchte; Stahl, chrom / Kunststoff, klar, satiniert
applique; acier, chrome / plastique, clair, satiné

L 450, H 70, A 125



3x 7,2W



3x
570lm



IP44



96543

LED



96937

LED



96938

LED

96937 CABUS

wall light; steel, chrome / plastic, satined
Wandleuchte; Stahl, chrom / Kunststoff, satiniert
applique; acier, chrome / plastique, satiné

L 450, H 45, A 115



3x 4,5W
3x
420lm

96938 CABUS

wall light; steel, chrome / plastic, satined
Wandleuchte; Stahl, chrom / Kunststoff, satiniert
applique; acier, chrome / plastique, satiné

L 580, H 45, A 115



4x 4,5W
4x
420lm

96939 CABUS

ceiling light; steel, chrome / plastic, satined
Deckenleuchte; Stahl, chrom / Kunststoff, satiniert
plafonnier; acier, chrome / plastique, satiné

L 350, B 350, H 45



5x 4,5W
5x
420lm



9 002759 969370

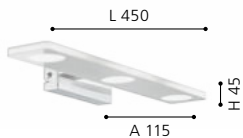

9 002759 969387

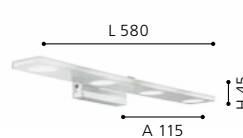

9 002759 969394

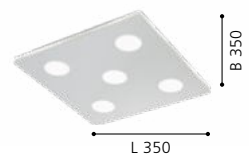



96939

LED





99692

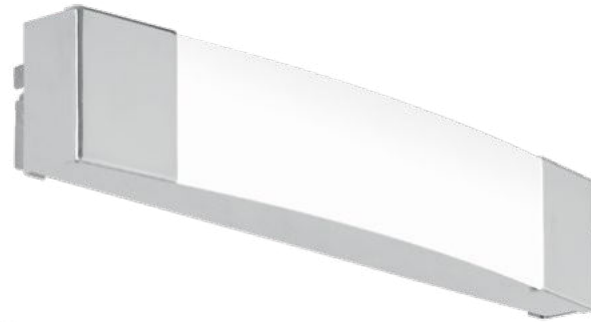

97718



97719



97718 SIDERNO

mirror light; steel, chrome / plastic, satiné
Spiegelleuchte; Stahl, chrom / Kunststoff, satiniert
applique pour miroir; acier, chrome / plastique, satiné

L 350, B 60, A 55



8,3W



900lm



IP44



97719 SIDERNO

mirror light; steel, chrome / plastic, satiné
Spiegelleuchte; Stahl, chrom / Kunststoff, satiniert
applique pour miroir; acier, chrome / plastique, satiné

L 580, B 60, A 65



16W



1700lm



IP44



99692 SANIA 5

wall light; steel, satin nickel, white / plastic, satiné
Wandleuchte; Stahl, nickel-matt, weiss / Kunststoff, satiniert
applique; acier, nickel mat, blanc / plastique, satiné

L 620, H 80, A 90



26,5W



2700lm



IP44



9 002759 977184

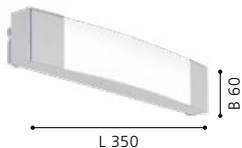

L 350

B 60



9 002759 977191

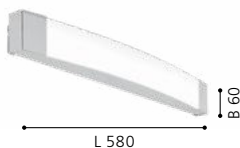

L 580

B 60



9 002759 996925

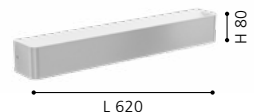

L 620

H 80



99691



99691 SANIA 5

wall light; steel, black, white / plastic, satined
Wandleuchte; Stahl, schwarz, weiss / Kunststoff, satiniert
applique; acier, noir, blanc / plastique, satiné

L 620, H 80, A 90



26,5W



2700lm



IP44



9 002759 996918

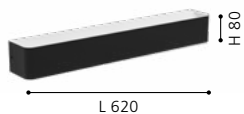



TRAGACETE 1

These luminaires refer to an on / off button directly on the luminaire.

Diese Leuchten verfügen über einen Ein-/Ausschaltknopf direkt an der Leuchte.

Ces luminaires se réfèrent à un bouton marche / arrêt directement sur le luminaire.



99776



99777



99778



99776 TRAGACETE 1

mirror light; plastic, steel, silver, chrome / plastic, white
Spiegelleuchte; Kunststoff, Stahl, silber, chrom / Kunststoff, weiss

applique pour miroir; plastique, acier, argent, chrome / plastique, blanc

L 450, B 45, H 45



7,5W



900lm



IP44



9 002759 997762



99777 TRAGACETE 1

mirror light; plastic, steel, silver, chrome / plastic, white
Spiegelleuchte; Kunststoff, Stahl, silber, chrom / Kunststoff, weiss

applique pour miroir; plastique, acier, argent, chrome / plastique, blanc

L 600, B 45, H 45



15,5W



1900lm



IP44



9 002759 997779



99778 TRAGACETE 1

mirror light; plastic, steel, silver, chrome / plastic, white
Spiegelleuchte; Kunststoff, Stahl, silber, chrom / Kunststoff, weiss

applique pour miroir; plastique, acier, argent, chrome / plastique, blanc

L 770, B 45, H 45



18,5W



2600lm



IP44



9 002759 997786





99339

LED

99339 TRAGACETE 1

mirror light; aluminium, silver, chrome / plastic, white
 Spiegelleuchte; Alu, silber, chrom / Kunststoff, weiss
 applique pour miroir; aluminium, argent, chrome / plastique, blanc

L 680, B 55, H 70

LED

15W

neutral
WHITE

1600lm



IP44

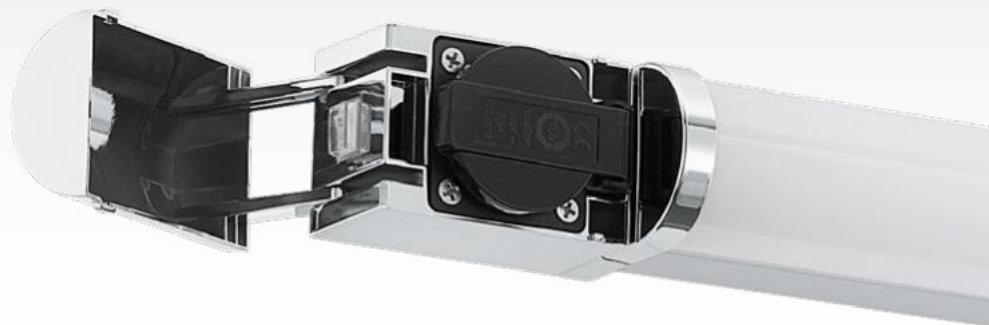

9 002759 993399

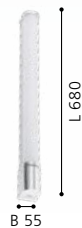

99339

This luminaire has a built-in socket.

Diese Leuchte verfügt über eine eingebaute Steckdose.

Cette luminaire a une douille intégrée.

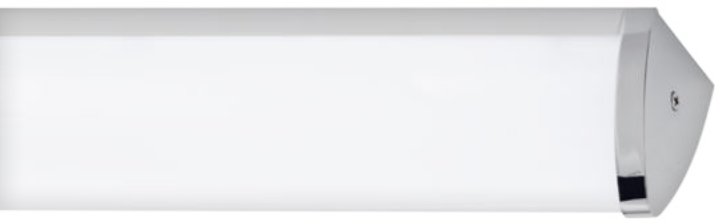

DESIGN
HIGHLIGHT
DETAIL



94712



94713



94712 GITA 2

wall / ceiling light; cast metal, chrome / plastic, white
Wand- / Deckenleuchte; Metallguss, chrom / Kunststoff, weiss
applique / plafonnier; fonte métallique, chrome / plastique,
blanc

L 350, B 75, H 75



8,3W 900lm



9 002759 947125



94713 GITA 2

wall / ceiling light; cast metal, chrome / plastic, white
Wand- / Deckenleuchte; Metallguss, chrom / Kunststoff, weiss
applique / plafonnier; fonte métallique, chrome / plastique,
blanc

L 600, B 75, H 75



16W 1700lm



9 002759 947132



94714 GITA 2

wall / ceiling light; cast metal, chrome / plastic, white
Wand- / Deckenleuchte; Metallguss, chrom / Kunststoff, weiss
applique / plafonnier; fonte métallique, chrome / plastique,
blanc

L 900, B 75, H 75



24,3W 2600lm



9 002759 947149

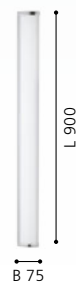



94714

LED

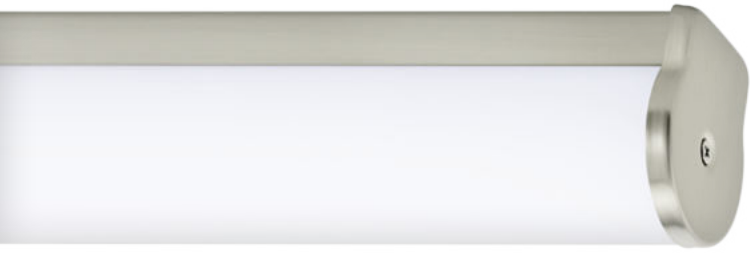

DESIGN
HIGHLIGHT
DETAIL



94715



94716



94717



94715 CALNOVA

wall light; steel, satin nickel / satin glass, white
Wandleuchte; Stahl, nickel-matt / Glas satiniert, weiss
applique; acier, nickel mat / verre satiné, blanc

L 350, B 50, A 85



9 002759 947156

CRI
>90



94716 CALNOVA

wall light; steel, satin nickel / satin glass, white
Wandleuchte; Stahl, nickel-matt / Glas satiniert, weiss
applique; acier, nickel mat / verre satiné, blanc

L 600, B 50, A 85



9 002759 947163

CRI
>90



94717 CALNOVA

wall light; steel, satin nickel / satin glass, white
Wandleuchte; Stahl, nickel-matt / Glas satiniert, weiss
applique; acier, nickel mat / verre satiné, blanc

L 900, B 50, A 85



9 002759 947170

CRI
>90

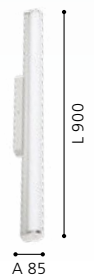



DESIGN
HIGHLIGHT
DETAIL



94616

LED



94617

LED



94618

LED

94616 TORRETTA

mirror light; steel, satin nickel / plastic, white
Spiegelleuchte; Stahl, nickel-matt / Kunststoff, weiss
applique pour miroir; acier, nickel mat / plastique, blanc

L 350, B 40, A 75



8W 770lm



9 002759 946166

CRI >90



94617 TORRETTA

mirror light; steel, satin nickel / plastic, white
Spiegelleuchte; Stahl, nickel-matt / Kunststoff, weiss
applique pour miroir; acier, nickel mat / plastique, blanc

L 600, B 40, A 75



16W 1500lm



9 002759 946173

CRI >90



94618 TORRETTA

mirror light; steel, satin nickel / plastic, white
Spiegelleuchte; Stahl, nickel-matt / Kunststoff, weiss
applique pour miroir; acier, nickel mat / plastique, blanc

L 900, B 40, A 75



24W 2200lm



9 002759 946180

CRI >90





94613

LED





94614



94612



94613 TABIANO

mirror light; steel, chrome / plastic, white
Spiegelleuchte; Stahl, chrom / Kunststoff, weiss
applique pour miroir; acier, chrome / plastique, blanc

L 605, H 70, A 130



3x 3,2W 900lm

94614 TABIANO

mirror light; steel, satin nickel / plastic, white
Spiegelleuchte; Stahl, nickel-matt / Kunststoff, weiss
applique pour miroir; acier, nickel mat / plastique, blanc

L 405, H 70, A 130



2x 3,2W 600lm

94612 TABIANO

mirror light; steel, chrome / plastic, white
Spiegelleuchte; Stahl, chrom / Kunststoff, weiss
applique pour miroir; acier, chrome / plastique, blanc

L 405, H 70, A 130



2x 3,2W 600lm



9 002759 946135



9 002759 946142



9 002759 946128





DESIGN
HIGHLIGHT
DETAIL



97081

LED



97082

LED

97081 VADUMI

wall light; plastic, chrome / plastic, white
Wandleuchte; Kunststoff, chrom / Kunststoff, weiss
applique; plastique, chrome / plastique, blanc

L 400, H 50, A 125



7,4W 900lm

97082 VADUMI

wall light; plastic, chrome / plastic, white
Wandleuchte; Kunststoff, chrom / Kunststoff, weiss
applique; plastique, chrome / plastique, blanc

L 600, H 50, A 125



11W 1350lm

97083 VADUMI

wall light; plastic, chrome / plastic, white
Wandleuchte; Kunststoff, chrom / Kunststoff, weiss
applique; plastique, chrome / plastique, blanc

L 780, H 50, A 125



14W 1700lm



9 002759 970819



9 002759 970826



9 002759 970833





97083

LED





98907



98908



99731



98907 PANDELLA 1

mirror light; aluminium, plastic, black / plastic, white
 Spiegelleuchte; Alu, Kunststoff, schwarz / Kunststoff, weiss
 applique pour miroir; aluminium, plastique, noir / plastique, blanc

L 400, H 40, A 120



7,4W 900lm

98908 PANDELLA 1

mirror light; aluminium, plastic, black / plastic, white
 Spiegelleuchte; Alu, Kunststoff, schwarz / Kunststoff, weiss
 applique pour miroir; aluminium, plastique, noir / plastique, blanc

L 600, H 40, A 120



11W 1350lm

99731 PANDELLA 2

mirror light; aluminium, plastic, black / plastic, white
 Spiegelleuchte; Alu, Kunststoff, schwarz / Kunststoff, weiss
 applique pour miroir; aluminium, plastique, noir / plastique, blanc

L 600, H 40, A 120



11W 1400lm



9 002759 989071

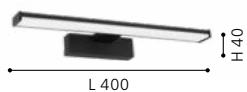

9 002759 989088



9 002759 997311





98677

LED

98677 PANDELLA 1

mirror light; aluminium, plastic, black / plastic, white
 Spiegelleuchte; Alu, Kunststoff, schwarz / Kunststoff, weiss
 applique pour miroir; aluminium, plastique, noir / plastique, blanc

L 780, H 40, A 120



14W



1700lm



IP44



DESIGN
HIGHLIGHT
DETAIL



9 002759 986773





96064

LED



96065

LED



96066

LED

96064 PANDELLA 1

mirror light; aluminium, plastic, chrome, silver / plastic, white
Spiegelleuchte; Alu, Kunststoff, chrom, silber / Kunststoff, weiss
applique pour miroir; aluminium, plastique, chrome, argent /
plastique, blanc

L 400, H 40, A 120



7,4W



900lm



IP44



96065 PANDELLA 1

mirror light; aluminium, plastic, chrome, silver / plastic, white
Spiegelleuchte; Alu, Kunststoff, chrom, silber / Kunststoff, weiss
applique pour miroir; aluminium, plastique, chrome, argent /
plastique, blanc

L 600, H 40, A 120



11W



1350lm



IP44



96066 PANDELLA 1

mirror light; aluminium, plastic, chrome, silver / plastic, white
Spiegelleuchte; Alu, Kunststoff, chrom, silber / Kunststoff, weiss
applique pour miroir; aluminium, plastique, chrome, argent /
plastique, blanc

L 780, H 40, A 120



14W



1700lm



IP44



9 002759 960643



9 002759 960650



9 002759 960667





99297

LED



99297 PANDELLA 1

mirror light; aluminium, plastic, chrome, silver / plastic, white
Spiegelleuchte; Alu, Kunststoff, chrom, silber / Kunststoff, weiss
applique pour miroir; aluminium, plastique, chrome, argent /
plastique, blanc

L 1200, H 40, A 120



14W



1700lm



IP44



DESIGN
HIGHLIGHT
DETAIL



9 002759 992972

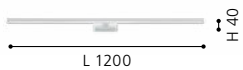



97059

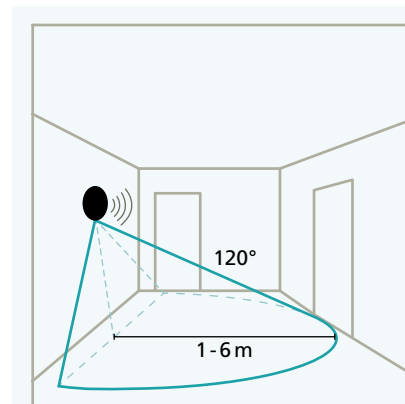

97059

This luminaire comes with an integrated motion sensor. The sensor is mounted invisibly behind the casing.

Diese Leuchte ist mit einem integrierten Bewegungssensor ausgestattet. Der Sensor ist unsichtbar hinter dem Gehäuse befestigt.

Ce luminaire vient avec un capteur de mouvement intégré. Le capteur est attaché invisiblement derrière le boîtier.

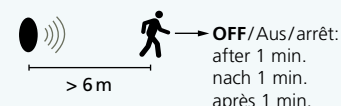
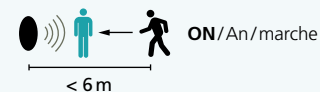

VINCHIO

These luminaires are delivered with a wiring and connection box that is 19.5 mm deep.

Diese Leuchten werden mit einer Verkabelungs- und Anschlussbox mit einer Tiefe von 19,5 mm geliefert.

Cette luminaires sont livré avec un boîtier de câblage et de connexion d'une profondeur de 19,5 mm.



98501



97059 PANDELLA 2

mirror light; plastic, silver, chrome / plastic, white
Spiegelleuchte; Kunststoff, silber, chrom / Kunststoff, weiss
applique pour miroir; plastique, argent, chrome / plastique, blanc

L 400, H 75, A 150



7,2W 1000lm



98501 VINCHIO

mirror light; steel, chrome / plastic, white
Spiegelleuchte; Stahl, chrom / Kunststoff, weiss
applique pour miroir; acier, chrome / plastique, blanc

L 400, H 50, A 140



6W 900lm



98502 VINCHIO

mirror light; steel, chrome / plastic, white
Spiegelleuchte; Stahl, chrom / Kunststoff, weiss
applique pour miroir; acier, chrome / plastique, blanc

L 600, H 50, A 140



10W 1500lm

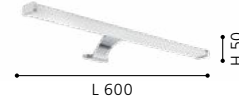



98502

LED



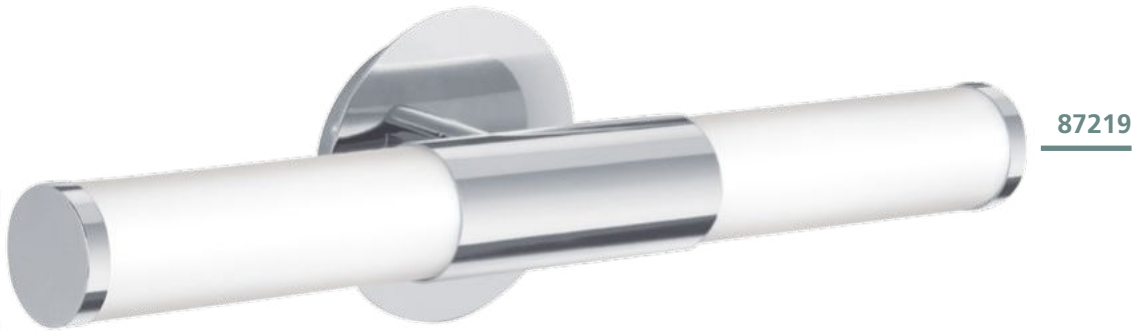

87219



87222



87219 | 87222



94989

LED

87219 PALMERA

wall light; steel, chrome / glass opal-matt, white
Wandleuchte; Stahl, chrom / Glas opal-matt, weiss
applique; acier, chrome / verre opale mat, blanc

L 460, A 110



E14 2x 40W IP44



9 002759 872199



L 460

87222 PALMERA

wall light; steel, satin nickel / glass opal-matt, white
Wandleuchte; Stahl, nickel-matt / Glas opal-matt, weiss
applique; acier, nickel mat / verre opale mat, blanc

L 460, A 110



E14 2x 40W IP44



9 002759 872229



L 460

94989 CAILIN

wall light; cast aluminium, chrome / satin glass, white
Wandleuchte; Aluguss, chrom / Glas satiniert, weiss
applique; fonte d'aluminium, chrome / verre satiné, blanc

L 90, H 270, A 115

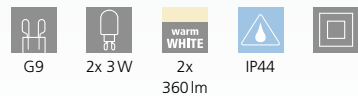

G9 2x 3W warm WHITE 2x 360lm IP44



9 002759 949891



A 115



85832 STICKER

mirror light; steel, chrome / glass opal-matt, white
Spiegelleuchte; Stahl, chrom / Glas opal-matt, weiss
applique pour miroir; acier, chrome / verre opale mat, blanc

L 70, H 115, A 95



E14



1x 40W



9 002759 858322





83406



83405



85338



83405 | 83406

83406 ZOLA

wall light; steel / glass opal-matt, white
Wandleuchte; Stahl / Glas opal-matt, weiss
applique; acier / verre opale mat, blanc

L 390, B 80



E14



2x 40W



9 002759 834067



B 80

L 390

83405 ZOLA

wall light; steel / glass opal-matt, white
Wandleuchte; Stahl / Glas opal-matt, weiss
applique; acier / verre opale mat, blanc

L 570, B 80



E14



3x 40W



9 002759 834050



B 80

L 570

85338 MONO

wall light; steel, chrome / satin glass, white
Wandleuchte; Stahl, chrom / Glas satiniert, weiss
applique; acier, chrome / verre satiné, blanc

L 340, B 70, A 65



E14



2x 40W



9 002759 853389



B 70

L 340



85339



94987

85339 MONO

wall light; steel, chrome / satin glass, white
Wandleuchte; Stahl, chrom / Glas satiniert, weiss
applique; acier, chrome / verre satiné, blanc

L 590, B 70, A 65



9 002759 853396



94987 BARI 1

mirror light; plastic, white / glass grooved, white
Spiegelleuchte; Kunststoff, weiss / Glas gerillt, weiss
applique pour miroir; plastique, blanc / verre rainuré, blanc

L 350, B 60, A 85



9 002759 949877



94987

This luminaire comes with an integrated power socket.

Diese Leuchte ist mit einer integrierten Steckdose ausgestattet.

Ce luminaire vient avec une prise de courant intégrée.

99202, 99203, 99206, 99207

These luminaires are protected against splash water.

Diese Leuchten sind gegen Spritzwasser geschützt.

Les luminaires sont protégées contre les éclaboussures d'eau.



	0	1	2	3
EU	X	X	✓	✓
FR	X	X	X	✓

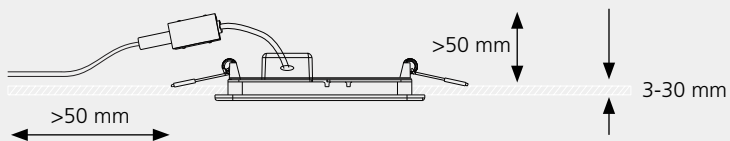

99202, 99203, 99206, 99207

Slim design and minimal installation depth. This makes it ideal for ceiling constructions with little space. Easy installation / replacement of the lights with practical connectors.

Schlanke Bauform und minimale Einbautiefe. Dadurch ideal für Deckenkonstruktionen mit wenig Platz. Einfache Montage / Austausch der Leuchten durch praktischen Verbinder.

Conception mince et profondeur d'installation minimale. Cela le rend idéal pour les constructions de plafond avec peu d'espace. Installation / remplacement facile des lumières avec des connecteurs pratiques.

99202 FUEVA 5

recessed light; steel, white / plastic, white
Einbauleuchte; Stahl, weiss / Kunststoff, weiss
luminaire encastrable; acier, blanc / plastique, blanc

Ø 86, ET 26



99203 FUEVA 5

recessed light; steel, white / plastic, white
Einbauleuchte; Stahl, weiss / Kunststoff, weiss
luminaire encastrable; acier, blanc / plastique, blanc

Ø 166, ET 26



99206 FUEVA 5

recessed light; steel, white / plastic, white
Einbauleuchte; Stahl, weiss / Kunststoff, weiss
luminaire encastrable; acier, blanc / plastique, blanc

Ø 86, ET 26



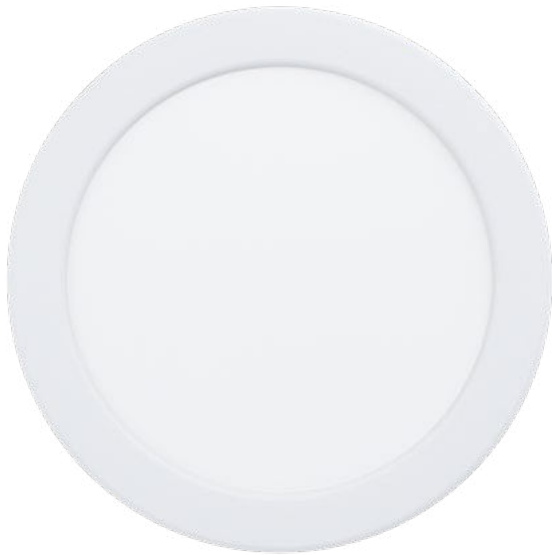

99203

LED

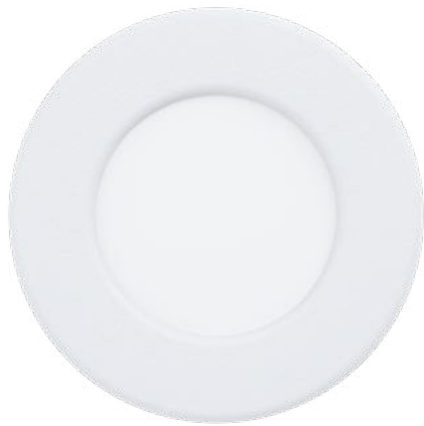

99206

LED

99207 FUEVA 5

recessed light; steel, white / plastic, white
Einbauleuchte; Stahl, weiss / Kunststoff, weiss
luminaire encastrable; acier, blanc / plastique, blanc

Ø 166, ET 26

LED

10,5W

neutral
WHITE

1350lm



Ø 155



IP44



9 002759 992071



RECESSED



Ø 166



99207

LED

99204, 99205, 99208, 99209

These luminaires are protected against splash water.

Diese Leuchten sind gegen Spritzwasser geschützt.

Les luminaires sont protégées contre les éclaboussures d'eau.



	0	1	2	3
EU	X	X	✓	✓
FR	X	X	X	✓



99208



99209

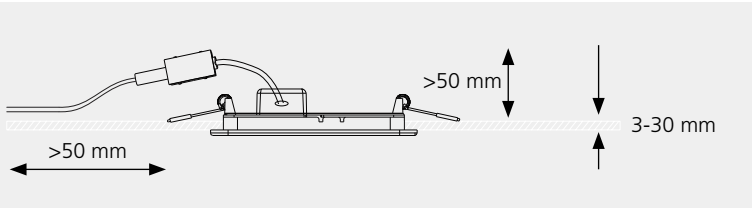

99204, 99205, 99208, 99209

Slim design and minimal installation depth. This makes it ideal for ceiling constructions with little space. Easy installation / replacement of the lights with practical connectors.

Schlanke Bauform und minimale Einbautiefe. Dadurch ideal für Deckenkonstruktionen mit wenig Platz. Einfache Montage / Austausch der Leuchten durch praktischen Verbinder.

Conception mince et profondeur d'installation minimale. Cela le rend idéal pour les constructions de plafond avec peu d'espace. Installation / remplacement facile des lumières avec des connecteurs pratiques.

99208 FUEVA 5

recessed light; steel, chrome / plastic, white
Einbauleuchte; Stahl, chrom / Kunststoff, weiss
luminaire encastrable; acier, chrome / plastique, blanc

Ø 86, ET 26



Ø 86

99209 FUEVA 5

recessed light; steel, chrome / plastic, white
Einbauleuchte; Stahl, chrom / Kunststoff, weiss
luminaire encastrable; acier, chrome / plastique, blanc

Ø 166, ET 26



Ø 166

99205 FUEVA 5

recessed light; steel, chrome / plastic, white
Einbauleuchte; Stahl, chrom / Kunststoff, weiss
luminaire encastrable; acier, chrome / plastique, blanc

Ø 166, ET 26



Ø 166



99205

LED



99204

LED

99204 FUEVA 5

recessed light; steel, chrome / plastic, white
Einbauleuchte; Stahl, chrom / Kunststoff, weiss
luminaire encastrable; acier, chrome / plastique, blanc

Ø 86, ET 26



2,7W

300lm

Ø 75

IP44



Ø 86

99211, 99212, 99213, 99214

These luminaires are protected against splash water.

Diese Leuchten sind gegen Spritzwasser geschützt.

Les luminaires sont protégées contre les éclaboussures d'eau.



	0	1	2	3
EU	X	X	✓	✓
FR	X	X	X	✓



99213

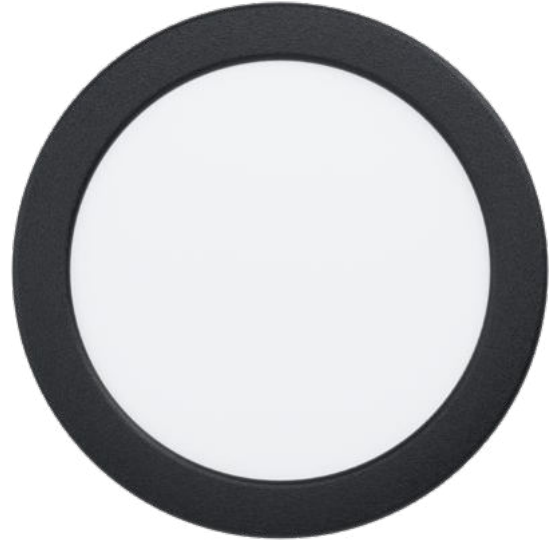

99214



99211, 99212, 99213, 99214

Slim design and minimal installation depth. This makes it ideal for ceiling constructions with little space. Easy installation / replacement of the lights with practical connectors.

Schlanke Bauform und minimale Einbautiefe. Dadurch ideal für Deckenkonstruktionen mit wenig Platz. Einfache Montage / Austausch der Leuchten durch praktischen Verbinder.

Conception mince et profondeur d'installation minimale. Cela le rend idéal pour les constructions de plafond avec peu d'espace. Installation / remplacement facile des lumières avec des connecteurs pratiques.

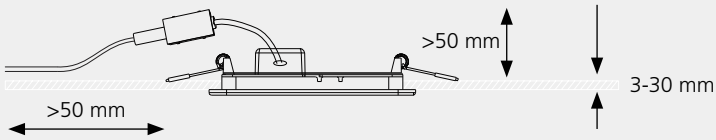

99213 FUEVA 5

recessed light; steel, black / plastic, white
Einbauleuchte; Stahl, schwarz / Kunststoff, weiss
luminaire encastrable; acier, noir / plastique, blanc

Ø 86, ET 26



Ø 86

99214 FUEVA 5

recessed light; steel, black / plastic, white
Einbauleuchte; Stahl, schwarz / Kunststoff, weiss
luminaire encastrable; acier, noir / plastique, blanc

Ø 166, ET 26



Ø 166

99212 FUEVA 5

recessed light; steel, black / plastic, white
Einbauleuchte; Stahl, schwarz / Kunststoff, weiss
luminaire encastrable; acier, noir / plastique, blanc

Ø 166, ET 26



Ø 166

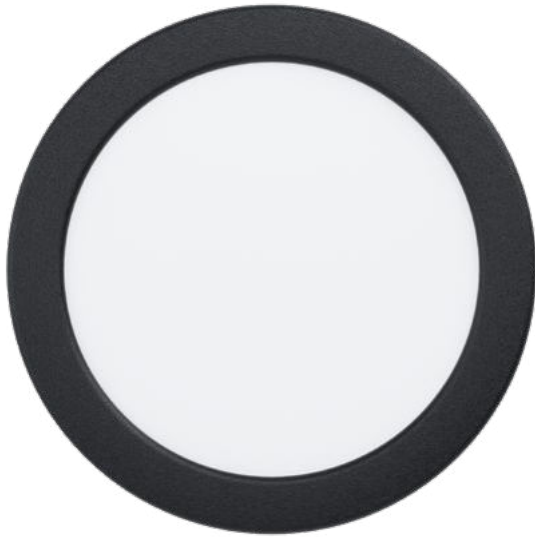

99212

LED



99211

LED

99211 FUEVA 5

recessed light; steel, black / plastic, white
Einbauleuchte; Stahl, schwarz / Kunststoff, weiss
luminaire encastrable; acier, noir / plastique, blanc

Ø 86, ET 26

LED

2,7W

warm
WHITE

300lm



Ø 75



IP44



Ø 86

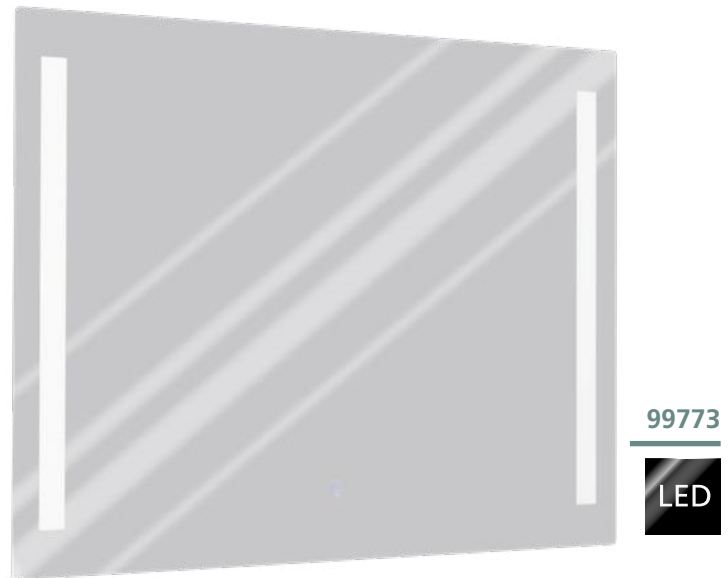

99772 BUENAVISTA

mirror light; aluminium, silver / mirror
Spiegelleuchte; Alu, silber / Spiegel
applique pour miroir; aluminium, argent / miroir

L 500, H 700, A 30

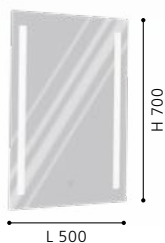
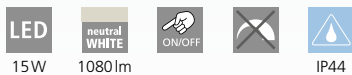

99773 BUENAVISTA

mirror light; aluminium, silver / mirror
Spiegelleuchte; Alu, silber / Spiegel
applique pour miroir; aluminium, argent / miroir

L 800, H 600, A 30

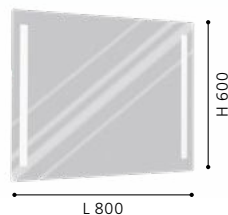
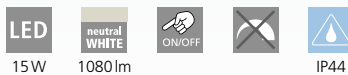

99774 BUENAVISTA

mirror light; aluminium, silver / mirror
Spiegelleuchte; Alu, silber / Spiegel
applique pour miroir; aluminium, argent / miroir

Ø 600, A 30

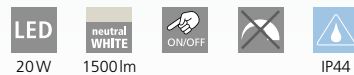



99774

LED



99838

LED

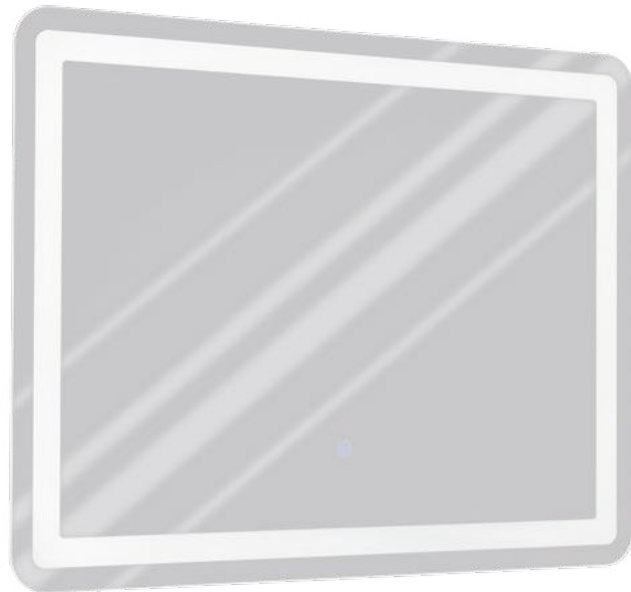

99839

LED

99838 BUENAVISTA 1

mirror light; aluminium, silver / mirror
Spiegelleuchte; Alu, silber / Spiegel
applique pour miroir; aluminium, argent / miroir

L 500, H 700, A 30



20W



1500lm



ON/OFF



IP44



9 002759 998387



L 500

H 700

99839 BUENAVISTA 1

mirror light; aluminium, silver / mirror
Spiegelleuchte; Alu, silber / Spiegel
applique pour miroir; aluminium, argent / miroir

L 800, H 600, A 30



24W



2000lm



ON/OFF



IP44



9 002759 998394

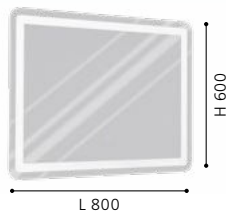

L 800

H 600

99853 BUENAVISTA 2

mirror light; aluminium, silver / mirror
Spiegelleuchte; Alu, silber / Spiegel
applique pour miroir; aluminium, argent / miroir

L 500, H 700, A 30



28W



1400lm



ON/OFF



IP44



9 002759 998530



L 500

H 700



99853



99854



99854 BUENAVISTA 2

mirror light; aluminium, silver / mirror
Spiegelleuchte; Alu, silber / Spiegel
applique pour miroir; aluminium, argent / miroir

L 800, H 600, A 30



24W



1200lm



ON/OFF



IP44



9 002759 998547

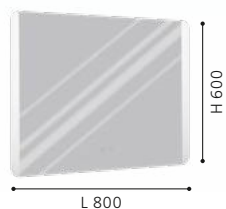

99853, 99854

The additional anti-fog function prevents the mirror from fogging up and ensures a clear view after showering.

Die zusätzliche Anti-Fog-Funktion verhindert das Beschlagen des Spiegels und sorgt für eine klare Sicht nach dem Duschen.

La fonction antibuée supplémentaire empêche le miroir de s'embuer et assure une vue dégagée après la douche.

SPOT & TRACK LUMINAIRES

SPOT- & SCHIENENLEUCHTEN
SPOTS & LUMINAIRES SUR RAIL

SYSTEMATIC LIGHTING -

Our spot & track luminaires set specific highlights while optimally lighting your living rooms. No matter whether you prefer a modern or a traditional look – our range will fit any taste.

BELEUCHTUNG MIT SYSTEM -

Mit unseren Spot- & Schienenleuchten setzen Sie gezielt Lichtakzente und sorgen zugleich für eine optimale Ausleuchtung Ihrer Wohnräume. Egal ob modern oder traditionell - unser Sortiment trifft jeden Geschmack.



UN ÉCLAIRAGE AVEC SYSTÈME -

Nos spots et nos luminaires sur rail vous permettent d'offrir des accents ponctuels de lumière et assurent parallèlement un éclairage optimal de vos pièces d'habitat. Qu'ils soient modernes ou traditionnels - notre gamme répond à tous les goûts.



OVERVIEW

SPOT & TRACK LUMINAIRES

							
TOWNSHEND 3 p. 620-623	VILLABATE p. 624-627	BATALLAS p. 628-629	ESTEPERRA p. 631	VALBIANO p. 632-633	POLLICA p. 634	BERREGAS p. 636	CONSACA p. 638
							
CASIBARE p. 640	COSWARTH p. 642	CAROVIGNO p. 644	SAMBATELLO p. 646-647	TABILLANO p. 648	ZAPATA 1 p. 650	ZAPATA p. 652-653	SERAS 1 p. 654-655
							
SERAS p. 656-657	SERAS 2 p. 658-659	DAKAR 1 p. 660-661	ENEA p. 662-663	BARNHAM p. 664-665	NOCITO p. 666-667	BIMEDA p. 668-671	LOCANDA p. 672
							
VERGIANO p. 674-675	DAVIDA p. 676-677	DAVIDA 1 p. 678-679	SARRIA p. 680-683	CORBERA p. 684	ZERACO p. 686	TUKON 3 p. 688	ROTTELO p. 690-691
							
BUZZ-LED p. 692-693	MAGNUM-LED p. 694-695	VILANOVA p. 696-697	CABO 1 p. 698	PAWEDO 1 p. 698	CARDILLIO 1 p. 700-701	SALTO p. 702-703	



This product is available in different colors and shapes./ Dieser Artikel ist in unterschiedlichen Farben und Formen verfügbar.
Cet article est disponible en différentes couleurs et formes.





33169 TOWNSHEND 3

spot; wood, steel, brown, white
 Spot; Holz, Stahl, braun, weiss
 spot; bois, acier, marron, blanc

L 300, B 50



E27

2x 60W



9 002759 331696



L 300

33171 TOWNSHEND 3

spot; wood, steel, brown, white
 Spot; Holz, Stahl, braun, weiss
 spot; bois, acier, marron, blanc

L 480, B 50



E27

3x 60W



9 002759 331719



L 480

33172 TOWNSHEND 3

spot; wood, steel, brown, white
 Spot; Holz, Stahl, braun, weiss
 spot; bois, acier, marron, blanc

L 630, B 50



E27

4x 60W



9 002759 331726



L 630



33172



33168

33168 TOWNSHEND 3

spot; wood, steel, brown, white
 Spot; Holz, Stahl, braun, weiss
 spot; bois, acier, marron, blanc

L 165, B 50



E27



1x 10W



9 002759 331689

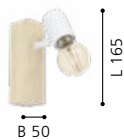



98112 TOWNSHEND 3

spot; wood, steel, brown, black
 Spot; Holz, Stahl, braun, schwarz
 spot; bois, acier, marron, noir

L 300, B 50

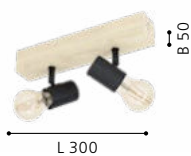

98113 TOWNSHEND 3

spot; wood, steel, brown, black
 Spot; Holz, Stahl, braun, schwarz
 spot; bois, acier, marron, noir

L 480, B 50

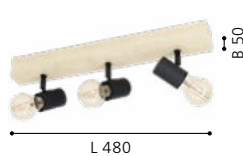

98114 TOWNSHEND 3

spot; wood, steel, brown, black
 Spot; Holz, Stahl, braun, schwarz
 spot; bois, acier, marron, noir

L 630, B 50

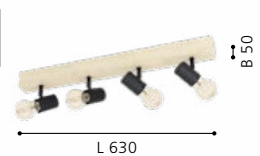



98114



98111

98111 TOWNSHEND 3

spot; wood, steel, brown, black
Spot; Holz, Stahl, braun, schwarz
spot; bois, acier, marron, noir

L 165, B 50



E27



1x 10W



9 002759 981112





98138



98139



98142

98138 VILLABATE

spot; steel, satin nickel / fabric, grey
Spot; Stahl, nickel-matt / Textil, grau
spot; acier, nickel mat / tissu, gris

Ø 120



E27



1x 10W

98139 VILLABATE

spot; steel, satin nickel / fabric, grey
Spot; Stahl, nickel-matt / Textil, grau
spot; acier, nickel mat / tissu, gris

L 335, B 90



E27



2x 10W

98142 VILLABATE

spot; steel, satin nickel / fabric, grey
Spot; Stahl, nickel-matt / Textil, grau
spot; acier, nickel mat / tissu, gris

L 795, B 90



E27



4x 10W



9 002759 981389

Ø 120



9 002759 981396



L 335

B 90



9 002759 981426



L 795

B 90



98141

98141 VILLABATE

spot; steel, satin nickel / fabric, grey
Spot; Stahl, nickel-matt / Textil, grau
spot; acier, nickel mat / tissu, gris

L 575, B 90



E27



3x 10W



9 002759 981419





33646

33647



33648

33646 VILLABATE

spot; steel, black / fabric, black, white
Spot; Stahl, schwarz / Textil, schwarz, weiss
spot; acier, noir / tissu, noir, blanc

L 335, B 90



E27 2x 10W

33647 VILLABATE

spot; steel, black / fabric, black, white
Spot; Stahl, schwarz / Textil, schwarz, weiss
spot; acier, noir / tissu, noir, blanc

L 575, B 90



E27 3x 10W

33648 VILLABATE

spot; steel, black / fabric, black, white
Spot; Stahl, schwarz / Textil, schwarz, weiss
spot; acier, noir / tissu, noir, blanc

L 795, B 90



E27 4x 10W



9 002759 336462



L 335



9 002759 336479



L 575



9 002759 336486



L 795



33645

33645 VILLABATE

spot; steel, black / fabric, black, white
Spot; Stahl, schwarz / Textil, schwarz, weiss
spot; acier, noir / tissu, noir, blanc

Ø 120



E27



1x 10W



9 002759 336455



Ø 120





99488 BATALLAS

spot; wood, steel, brown, black / fabric, black, white
 Spot; Holz, Stahl, braun, schwarz / Textil, schwarz, weiss
 spot; bois, acier, marron, noir / tissu, noir, blanc

L 100, H 170, A 205



99489 BATALLAS

spot; wood, steel, brown, black / fabric, black, white
 Spot; Holz, Stahl, braun, schwarz / Textil, schwarz, weiss
 spot; bois, acier, marron, noir / tissu, noir, blanc

L 300, B 50



99491 BATALLAS

spot; wood, steel, brown, black / fabric, black, white
 Spot; Holz, Stahl, braun, schwarz / Textil, schwarz, weiss
 spot; bois, acier, marron, noir / tissu, noir, blanc

L 480, B 50



9 002759 994884

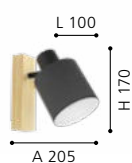

9 002759 994891

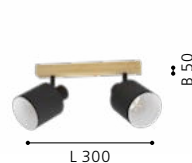

9 002759 994914

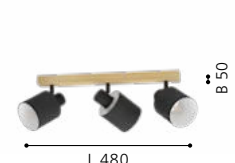



99492



99492 BATALLAS

spot; wood, steel, brown, black / fabric, black, white
Spot; Holz, Stahl, braun, schwarz / Textil, schwarz, weiss
spot; bois, acier, marron, noir / tissu, noir, blanc

L 630, B 50



E27



4x 10W



9 002759 994921

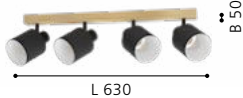



99278

DESIGN
HIGHLIGHT
DETAIL



99277



99276

99278 ESTEPERRA

spot; steel, black / fabric, black, gold
Spot; Stahl, schwarz / Textil, schwarz, gold
spot; acier, noir / tissu, noir, or

L 575, B 90



E27 3x 28W



9 002759 992781



L 575

B 90

99277 ESTEPERRA

spot; steel, black / fabric, black, gold
Spot; Stahl, schwarz / Textil, schwarz, gold
spot; acier, noir / tissu, noir, or

L 335, B 90



E27 2x 28W



9 002759 992774



L 335

B 90

99276 ESTEPERRA

spot; steel, black / fabric, black, gold
Spot; Stahl, schwarz / Textil, schwarz, gold
spot; acier, noir / tissu, noir, or

H 240, Ø 120



E27 1x 28W



9 002759 992767

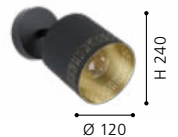

Ø 120

H 240



97536



97537



97538

97536 VALBIANO

spot; steel, brushed brass, satin nickel / fabric, cappuccino, gold
Spot; Stahl, messing-gebürstet, nickel-matt / Textil, cappuccino, gold
spot; acier, laiton brossé, nickel mat / tissu, cappuccino, or

L 110, B 110



E14



1x 7W

97537 VALBIANO

spot; steel, brushed brass, satin nickel / fabric, cappuccino, gold
Spot; Stahl, messing-gebürstet, nickel-matt / Textil, cappuccino, gold
spot; acier, laiton brossé, nickel mat / tissu, cappuccino, or

L 320, B 70



E14



2x 7W

97538 VALBIANO

spot; steel, brushed brass, satin nickel / fabric, cappuccino, gold
Spot; Stahl, messing-gebürstet, nickel-matt / Textil, cappuccino, gold
spot; acier, laiton brossé, nickel mat / tissu, cappuccino, or

L 560, B 70



E14



3x 7W



9 002759 975364



L 110



9 002759 975371

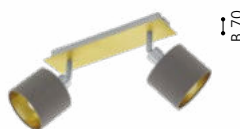

L 320



9 002759 975388



L 560



97539 VALBIANO

spot; steel, brushed brass, satin nickel / fabric, cappuccino, gold
Spot; Stahl, messing-gebürstet, nickel-matt / Textil, cappuccino, gold
spot; acier, laiton brossé, nickel mat / tissu, cappuccino, or

L 780, B 70



E14



4x 7W



9 002759 975395

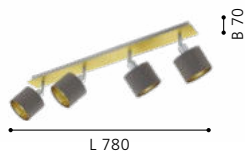



98624



98624 | 98625 | 98626



98625

98624 POLLICA

spot; steel, black / glass vaporized, black-transparent
Spot; Stahl, schwarz / Glas bedampft, schwarz-transparent
spot; acier, noir / verre vaporisé, noir transparent

L 65, H 105



E14 1x 10W



9 002759 986247

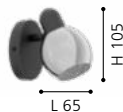

98625 POLLICA

spot; steel, black / glass vaporized, black-transparent
Spot; Stahl, schwarz / Glas bedampft, schwarz-transparent
spot; acier, noir / verre vaporisé, noir transparent

L 365, B 165

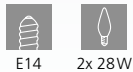

E14 2x 28W



9 002759 986254



98626 POLLICA

spot; steel, black / glass vaporized, black-transparent
Spot; Stahl, schwarz / Glas bedampft, schwarz-transparent
spot; acier, noir / verre vaporisé, noir transparent

L 640, B 220

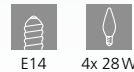

E14 4x 28W



9 002759 986261





98626





99052



99052 | 99053 | 99054



99053

99052 BERREGAS

spot; steel, black, chrome / glass vaporized, black-transparent
Spot; Stahl, schwarz, chrom / Glas bedampft, schwarz-transparent
spot; acier, noir, chrome / verre vaporisé, noir transparent

Ø 110



E27

1x 28W

99053 BERREGAS

spot; steel, black, chrome / glass vaporized, black-transparent
Spot; Stahl, schwarz, chrom / Glas bedampft, schwarz-transparent
spot; acier, noir, chrome / verre vaporisé, noir transparent

L 440, B 110



E27

2x 40W

99054 BERREGAS

spot; steel, black, chrome / glass vaporized, black-transparent
Spot; Stahl, schwarz, chrom / Glas bedampft, schwarz-transparent
spot; acier, noir, chrome / verre vaporisé, noir transparent

L 775, B 110



E27

3x 40W



9 002759 990527



Ø 110



9 002759 990534



L 440

B 110



9 002759 990541



L 775

B 110



99054





99711



99711 | 99712 | 99713



99713

99711 CONSACA

spot; steel, black / glass vaporized, black-transparent
Spot; Stahl, schwarz / Glas bedampft, schwarz-transparent
spot; acier, noir / verre vaporisé, noir transparent

L 120, H 220, A 160



E27

1x 28W

99713 CONSACA

spot; steel, black / glass vaporized, black-transparent
Spot; Stahl, schwarz / Glas bedampft, schwarz-transparent
spot; acier, noir / verre vaporisé, noir transparent

L 780, H 205, A 160



E27

4x 40W

99712 CONSACA

spot; steel, black / glass vaporized, black-transparent
Spot; Stahl, schwarz / Glas bedampft, schwarz-transparent
spot; acier, noir / verre vaporisé, noir transparent

L 340, H 205, A 160



E27

2x 40W



9 002759 997113



9 002759 997137



9 002759 997120





99712



99517



99518

99517 CASIBARE

spot; steel, black
Spot; Stahl, schwarz
spot; acier, noir

L 120, H 185, A 190



E27



1x 28W



9 002759 995171



99518 CASIBARE

spot; steel, black
Spot; Stahl, schwarz
spot; acier, noir

L 335, H 175, A 180



E27



2x 28W



9 002759 995188



99519 CASIBARE

spot; steel, black
Spot; Stahl, schwarz
spot; acier, noir

L 575, H 175, A 180



E27



3x 28W



9 002759 995195





99519





99075 COSWARTH

spot; steel, wood, anthracite, cream-white, brown
 Spot; Stahl, Holz, anthrazit, creme-weiss, braun
 spot; acier, bois, anthracite, blanc crème, marron

L 480, B 140, H 240



E27



2x 40W

99076 COSWARTH

spot; steel, wood, anthracite, cream-white, brown
 Spot; Stahl, Holz, anthrazit, creme-weiss, braun
 spot; acier, bois, anthracite, blanc crème, marron

L 670, B 140, H 240



E27



3x 40W

99074 COSWARTH

spot; steel, wood, anthracite, cream-white, brown
 Spot; Stahl, Holz, anthrazit, creme-weiss, braun
 spot; acier, bois, anthracite, blanc crème, marron

L 140, H 200



E27



1x 25W



9 002759 990756



9 002759 990763



9 002759 990749





99074





98621



98623

98621 CAROVIGNO

spot; steel, black
Spot; Stahl, schwarz
spot; acier, noir

L 65, H 105



E14

1x 28W

98623 CAROVIGNO

spot; steel, black
Spot; Stahl, schwarz
spot; acier, noir

L 640, B 150



E14

4x 40W

98622 CAROVIGNO

spot; steel, black
Spot; Stahl, schwarz
spot; acier, noir

L 365, B 150



E14

2x 40W



9 002759 986216

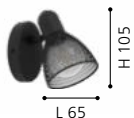

9 002759 986230

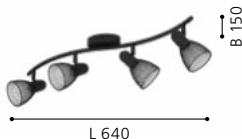

9 002759 986223



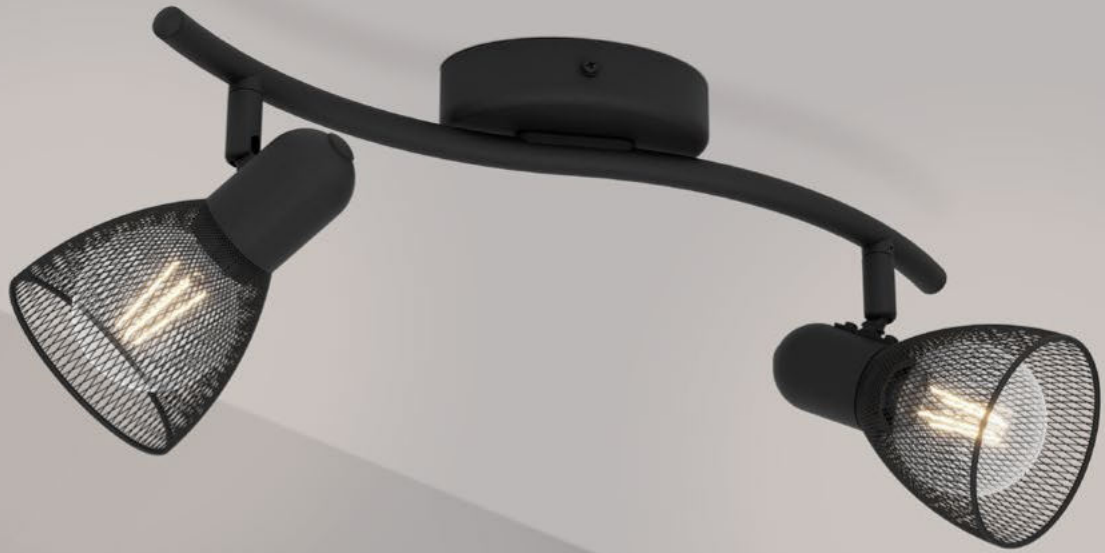

98622



98134



98135



98137

98134 SAMBATELLO

spot; wood, steel, brown, silver / steel, silver
 Spot; Holz, Stahl, braun, silber / Stahl, silber
 spot; bois, acier, marron, argent / acier, argent

L 150, H 220, A 240



E27

1x 40W

98135 SAMBATELLO

spot; wood, steel, brown, silver / steel, silver
 Spot; Holz, Stahl, braun, silber / Stahl, silber
 spot; bois, acier, marron, argent / acier, argent

L 335, B 90



E27

2x 40W

98137 SAMBATELLO

spot; wood, steel, brown, silver / steel, silver
 Spot; Holz, Stahl, braun, silber / Stahl, silber
 spot; bois, acier, marron, argent / acier, argent

L 795, B 90



E27

4x 40W



9 002759 981341

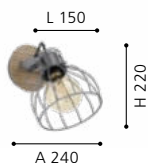

9 002759 981358



9 002759 981372

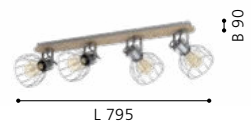



98136

98136 SAMBATELLO

spot; wood, steel, brown, silver / steel, silver
Spot; Holz, Stahl, braun, silber / Stahl, silber
spot; bois, acier, marron, argent / acier, argent

L 575, B 90



E27



3x 40W



9 002759 981365





98763 TABILLANO

spot; steel, black
Spot; Stahl, schwarz
spot; acier, noir

L 440, B 110



E27

2x 40W

98764 TABILLANO

spot; steel, black
Spot; Stahl, schwarz
spot; acier, noir

L 775, B 110



E27

3x 40W

98762 TABILLANO

spot; steel, black
Spot; Stahl, schwarz
spot; acier, noir

Ø 110



E27

1x 40W



9 002759 987633

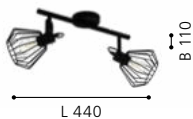

9 002759 987640



9 002759 987626





98762





32765

LED



32767

LED

32765 ZAPATA 1

spot; steel, black / glass, amber
Spot; Stahl, schwarz / Glas, amber
spot; acier, noir / verre, ambre

Ø 60



G9



1x 3W



1x
360lm

32767 ZAPATA 1

spot; steel, black / glass, amber
Spot; Stahl, schwarz / Glas, amber
spot; acier, noir / verre, ambre

L 635, B 65



G9



4x 3W



4x
360lm

32766 ZAPATA 1

spot; steel, black / glass, amber
Spot; Stahl, schwarz / Glas, amber
spot; acier, noir / verre, ambre

L 360, B 65



G9



2x 3W



2x
360lm



9 002759 327651



Ø 60



9 002759 327675



L 635

B 65



9 002759 327668



L 360

B 65



32766

LED



95545

LED



95546

LED



95548

LED



95545 ZAPATA

spot; steel, copper / satin glass, white
Spot; Stahl, kupfer / Glas satiniert, weiss
spot; acier, cuivre / verre satiné, blanc

Ø 60



G9



1x 3W



warm
WHITE

1x
360lm

95546 ZAPATA

spot; steel, copper / satin glass, white
Spot; Stahl, kupfer / Glas satiniert, weiss
spot; acier, cuivre / verre satiné, blanc

L 360, B 65



G9



2x 3W



warm
WHITE

2x
360lm

95548 ZAPATA

spot; steel, copper / satin glass, white
Spot; Stahl, kupfer / Glas satiniert, weiss
spot; acier, cuivre / verre satiné, blanc

L 635, B 65



G9



4x 3W



warm
WHITE

4x
360lm



9 002759 955458



Ø 60



9 002759 955465



B 65

L 360



9 002759 955489



B 65

L 635



95547

LED

95547 ZAPATA

spot; steel, copper / satin glass, white
 Spot; Stahl, kupfer / Glas satiniert, weiss
 spot; acier, cuivre / verre satiné, blanc

L 515, B 65



G9



3x 3W



3x
 warm
 WHITE
 360lm





98393

LED



98394

LED



98396

LED

98393 SERAS 1

spot; steel, white
Spot; Stahl, weiss
spot; acier, blanc

Ø 100



GU10



1x 3W



1x
warm
WHITE
250lm

98394 SERAS 1

spot; steel, white
Spot; Stahl, weiss
spot; acier, blanc

L 370, B 65



GU10



2x 3W



2x
warm
WHITE
250lm

98396 SERAS 1

spot; steel, white
Spot; Stahl, weiss
spot; acier, blanc

L 770, B 65



GU10



4x 3W



4x
warm
WHITE
250lm



9 002759 983932



Ø 100



9 002759 983949



L 370



9 002759 983963



L 770



98395

LED

98395 SERAS 1

spot; steel, white
Spot; Stahl, weiss
spot; acier, blanc

L 595, B 65



GU10



3x 3W



warm
WHITE
3x
250lm



9 002759 983956





96552

LED



DESIGN
HIGHLIGHT
DETAIL



96552 SERAS

spot; steel, nickel-antique, creme
Spot; Stahl, nickel-antik, creme
spot; acier, nickel-antique, crème

Ø 100



GU10



1x 3W



warm
WHITE
1x
250lm



9 002759 965525



INCL.

Ø 100





96553

LED



96554

LED



96555

LED

96553 SERAS

spot; steel, nickel-antique, creme
Spot; Stahl, nickel-antik, creme
spot; acier, nickel-antique, crème

L 370, B 65



GU10



2x 3W



2x
warm
WHITE
250lm

96554 SERAS

spot; steel, nickel-antique, creme
Spot; Stahl, nickel-antik, creme
spot; acier, nickel-antique, crème

L 595, B 65



GU10



3x 3W



3x
warm
WHITE
250lm

96555 SERAS

spot; steel, nickel-antique, creme
Spot; Stahl, nickel-antik, creme
spot; acier, nickel-antique, crème

L 770, B 65



GU10



4x 3W



4x
warm
WHITE
250lm



9 002759 965532



L 370



9 002759 965549



L 595



9 002759 965556



L 770



98398

LED



98397

LED

98398 SERAS 2

spot; steel, black
Spot; Stahl, schwarz
spot; acier, noir

L 370, B 65



GU10



2x 3W



warm
WHITE

2x

250lm



9 002759 983987



INCL.



L 370

B 65



98399

LED



98408

LED

98397 SERAS 2

spot; steel, black
Spot; Stahl, schwarz
spot; acier, noir

Ø 100

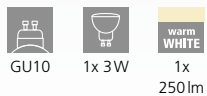

98399 SERAS 2

spot; steel, black
Spot; Stahl, schwarz
spot; acier, noir

L 595, B 65

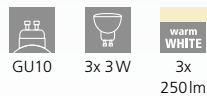

98408 SERAS 2

spot; steel, black
Spot; Stahl, schwarz
spot; acier, noir

L 770, B 65

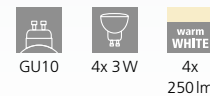

9 002759 983970



9 002759 983994



9 002759 984083





DESIGN
HIGHLIGHT
DETAIL



88472



88475

88472 DAKAR 1

spot; steel, satin nickel / glass wiping technique, white
Spot; Stahl, nickel-matt / Glas Wischtechnik, weiss
spot; acier, nickel mat / technique d'essuie de verre, blanc

L 105, B 65



E14



1x 25W



9 002759 884727



L 105

88475 DAKAR 1

spot; steel, satin nickel / glass wiping technique, white
Spot; Stahl, nickel-matt / Glas Wischtechnik, weiss
spot; acier, nickel mat / technique d'essuie de verre, blanc

Ø 295



E14



3x 40W



9 002759 884758



Ø 295

88474 DAKAR 1

spot; steel, satin nickel / glass wiping technique, white
Spot; Stahl, nickel-matt / Glas Wischtechnik, weiss
spot; acier, nickel mat / technique d'essuie de verre, blanc

L 650, B 100



E14



4x 40W



9 002759 884741



L 650

B 100



88474



88473

88473 DAKAR 1

spot; steel, satin nickel / glass wiping technique, white
 Spot; Stahl, nickel-matt / Glas Wischtechnik, weiss
 spot; acier, nickel mat / technique d'essuie de verre, blanc

L 370, B 100



E14



2x 40W



9 002759 884734





90984 ENEA

spot; steel, satin nickel / satin glass, white
 Spot; Stahl, nickel-matt / Glas satiniert, weiss
 spot; acier, nickel mat / verre satiné, blanc

L 300, B 70



90986 ENEA

spot; steel, satin nickel / satin glass, white
 Spot; Stahl, nickel-matt / Glas satiniert, weiss
 spot; acier, nickel mat / verre satiné, blanc

Ø 265



90985 ENEA

spot; steel, satin nickel / satin glass, white
 Spot; Stahl, nickel-matt / Glas satiniert, weiss
 spot; acier, nickel mat / verre satiné, blanc

L 500, B 70

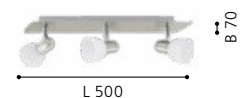
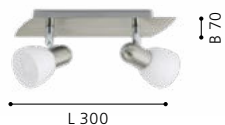



90982

90982 ENEA

spot; steel, satin nickel / satin glass, white
Spot; Stahl, nickel-matt / Glas satiniert, weiss
spot; acier, nickel mat / verre satiné, blanc

L 190, B 70



E14



1x 25W



9 002759 909826

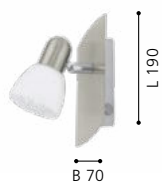



94585 BARNHAM

spot; steel, black, copper
Spot; Stahl, schwarz, kupfer
spot; acier, noir, cuivre

L 395, B 70

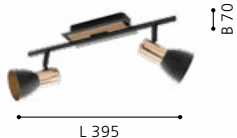
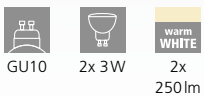

94586 BARNHAM

spot; steel, black, copper
Spot; Stahl, schwarz, kupfer
spot; acier, noir, cuivre

L 585, B 70

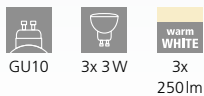

94587 BARNHAM

spot; steel, black, copper
Spot; Stahl, schwarz, kupfer
spot; acier, noir, cuivre

L 780, B 70

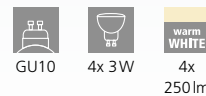



94587

LED

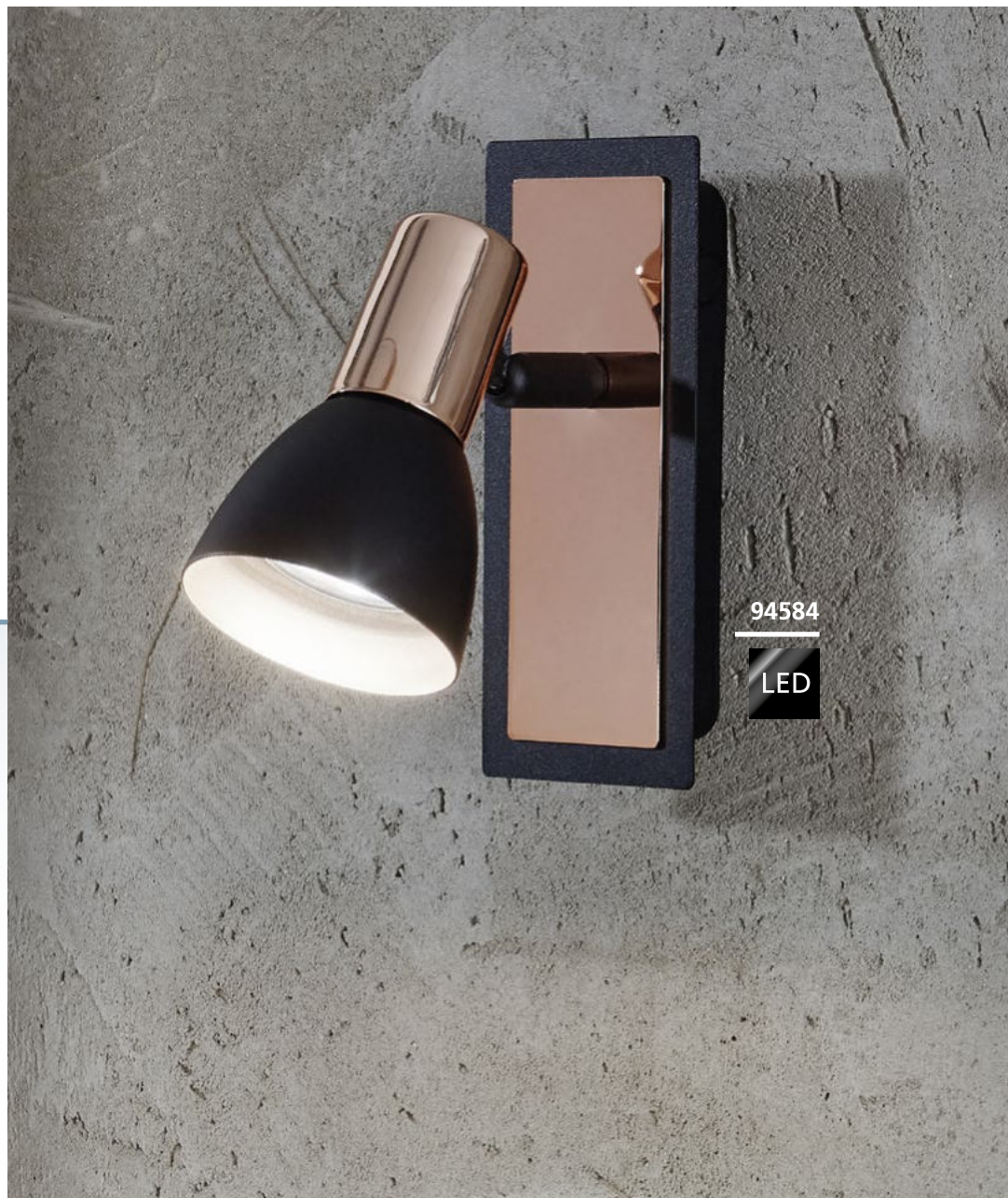

94584

LED

94584 BARNHAM

spot; steel, black, copper
 Spot; Stahl, schwarz, kupfer
 spot; acier, noir, cuivre

L 165, B 70



GU10



1x 3W



warm
 WHITE
 1x
 250lm



9 002759 945848



INCL.



B 70

L 165



95482

LED



95483

LED



95485

LED

95482 NOCITO

spot; steel, black, gold
Spot; Stahl, schwarz, gold
spot; acier, noir, or

Ø 110



GU10



1x 3W



1x
warm
WHITE
250lm

Ø 110



95483 NOCITO

spot; steel, black, gold
Spot; Stahl, schwarz, gold
spot; acier, noir, or

L 360, B 105



GU10



2x 3W



2x
warm
WHITE
250lm

9



002759 954833



L 360

95485 NOCITO

spot; steel, black, gold
Spot; Stahl, schwarz, gold
spot; acier, noir, or

L 760, B 105



GU10



4x 3W



4x
warm
WHITE
250lm

9



002759 954857



L 760



95484

LED

95484 NOCITO

spot; steel, black, gold
Spot; Stahl, schwarz, gold
spot; acier, noir, or

L 585, B 105



GU10



3x 3W



warm
WHITE

3x

250lm



9 002759 954840



DESIGN
HIGHLIGHT
DETAIL



31001

LED



31003

LED



31004

LED

31001 BIMEDA

spot; steel, white, chrome
Spot; Stahl, weiss, chrom
spot; acier, blanc, chrome

Ø 70



GU10



1x 3W



1x

240lm

31003 BIMEDA

spot; steel, white, chrome
Spot; Stahl, weiss, chrom
spot; acier, blanc, chrome

L 290, H 345



GU10



3x 3W



3x

240lm

31004 BIMEDA

spot; steel, white, chrome
Spot; Stahl, weiss, chrom
spot; acier, blanc, chrome

L 640, B 100



GU10



4x 3W



4x

240lm



L 290

H 345



L 640

B 100



31002

LED

31002 BIMEDA

spot; steel, white, chrome
Spot; Stahl, weiss, chrom
spot; acier, blanc, chrome

L 365



GU10



2x 3W



warm
WHITE
2x
240lm



9 002759 310028



INCL.



L 365



31005

LED



DESIGN
HIGHLIGHT
DETAIL

31005 BIMEDA

spot; steel, nickel-nero, chrome
Spot; Stahl, nickel-nero, chrom
spot; acier, nickel nero, chrome

Ø 70



GU10



1x 3W



1x
warm
WHITE
240lm



9 002759 310059



INCL.

Ø 70





31008

LED



31007

LED



31006

LED

31006 BIMEDA

spot; steel, nickel-nero, chrome
Spot; Stahl, nickel-nero, chrom
spot; acier, nickel nero, chrome

L 365



GU10



2x 3W



warm
WHITE

2x
240lm

31007 BIMEDA

spot; steel, nickel-nero, chrome
Spot; Stahl, nickel-nero, chrom
spot; acier, nickel nero, chrome

L 290, H 345



GU10



3x 3W



warm
WHITE

3x
240lm

31008 BIMEDA

spot; steel, nickel-nero, chrome
Spot; Stahl, nickel-nero, chrom
spot; acier, nickel nero, chrome

L 640, B 100



GU10



4x 3W



warm
WHITE

4x
240lm



9 002759 310066



L 365



9 002759 310073



L 290

H 345



9 002759 310080



L 640

B 100

DESIGN
HIGHLIGHT
DETAIL



94251

LED

94251 LOCANDA

ceiling light; steel, satin nickel, chrome
Deckenleuchte; Stahl, nickel-matt, chrom
plafonnier; acier, nickel mat, chrome

L 700, B 660



GU10



5x 3W



5x
warm
WHITE
240lm



9 002759 942519



L 700

94252 LOCANDA

ceiling light; steel, white, chrome
Deckenleuchte; Stahl, weiss, chrom
plafonnier; acier, blanc, chrome

L 700, B 660



GU10



5x 3W



5x
warm
WHITE
240lm



9 002759 942526



L 700



94252





97506

LED



97507

LED

97506 VERGIANO

spot; aluminium, steel, white, satin nickel
Spot; Alu, Stahl, weiss, nickel-matt
spot; aluminium, acier, blanc, nickel mat

L 70, H 165



GU10



1x 5W



warm
WHITE
1x
400lm



9 002759 975067

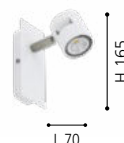

L 70

H 165



9 002759 975074



L 390, B 70



GU10



2x 5W



warm
WHITE
2x
400lm



L 390

B 70



97508

LED

97509

LED

STEP DIMMING
25/50/100%

97506

97508

97507

97509

97508 VERGIANO

spot; aluminium, steel, white, satin nickel
Spot; Alu, Stahl, weiss, nickel-matt
spot; aluminium, acier, blanc, nickel mat

L 690, B 70

GU10
 3x 5W
 warm WHITE
 3x 400lm

97509 VERGIANO

spot; aluminium, steel, white, satin nickel
Spot; Alu, Stahl, weiss, nickel-matt
spot; aluminium, acier, blanc, nickel mat

L 980, B 70

GU10
 4x 5W
 warm WHITE
 4x 400lm

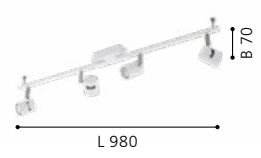
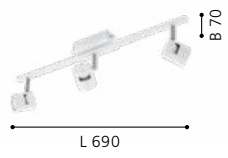



92084

LED



92085

LED



92086

LED

92084 DAVIDA

spot; steel, chrome, white
Spot; Stahl, chrom, weiss
spot; acier, chrome, blanc

L 165, B 70



92085 DAVIDA

spot; steel, chrome, white
Spot; Stahl, chrom, weiss
spot; acier, chrome, blanc

L 390, B 70

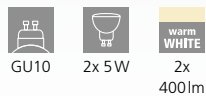

92086 DAVIDA

spot; steel, chrome, white
Spot; Stahl, chrom, weiss
spot; acier, chrome, blanc

L 580, B 70

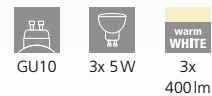



92087

LED

92087 DAVIDA

spot; steel, chrome, white
Spot; Stahl, chrom, weiss
spot; acier, chrome, blanc

L 780, B 70



GU10



4x 5W



warm
WHITE
4x
400lm



9 002759 920876



DESIGN
HIGHLIGHT
DETAIL





30833

LED



30832

LED

30832 DAVIDA 1

spot; steel, nickel-nero
 Spot; Stahl, nickel-nero
 spot; acier, nickel noir

L 165, B 70



GU10



1x 5W



warm
 WHITE

1x

400lm



9 002759 308322



INCL.



B 70

L 165



30834

LED



30835

LED

30833 DAVIDA 1

spot; steel, nickel-nero
Spot; Stahl, nickel-nero
spot; acier, nickel noir

L 390, B 70

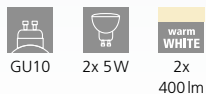

9 002759 308339



L 390

B 70

30834 DAVIDA 1

spot; steel, nickel-nero
Spot; Stahl, nickel-nero
spot; acier, nickel noir

L 580, B 70



9 002759 308346



L 580

B 70

30835 DAVIDA 1

spot; steel, nickel-nero
Spot; Stahl, nickel-nero
spot; acier, nickel noir

L 780, B 70



9 002759 308353



L 780

B 70



94962

LED



94958

LED

94962 SARRIA

spot; steel, white, chrome
Spot; Stahl, weiss, chrom
spot; acier, blanc, chrome

L 240, H 260



GU10



4x 4,5W



warm
WHITE

4x

345lm



9 002759 949624



INCL.



H 260

L 240



94959

LED



94961

LED

94958 SARRIA

spot; steel, white, chrome
Spot; Stahl, weiss, chrom
spot; acier, blanc, chrome

L 120, B 60

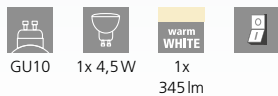

94959 SARRIA

spot; steel, white, chrome
Spot; Stahl, weiss, chrom
spot; acier, blanc, chrome

L 300, B 70

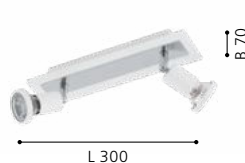
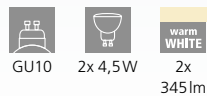

94961 SARRIA

spot; steel, white, chrome
Spot; Stahl, weiss, chrom
spot; acier, blanc, chrome

L 460, B 70

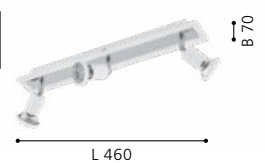
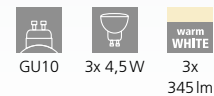



94963



94966



94964



94963 SARRIA

spot; steel, black, chrome
Spot; Stahl, schwarz, chrom
spot; acier, noir, chrome

L 120, B 60

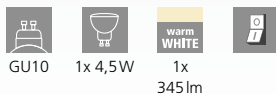

94964 SARRIA

spot; steel, black, chrome
Spot; Stahl, schwarz, chrom
spot; acier, noir, chrome

L 300, B 70

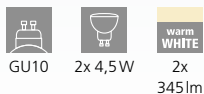

94966 SARRIA

spot; steel, black, chrome
Spot; Stahl, schwarz, chrom
spot; acier, noir, chrome

L 240, H 260

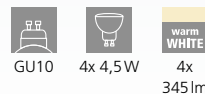

9 002759 949631



B 60



9 002759 949648



L 300



9 002759 949662



L 240



94965 SARRIA

spot; steel, black, chrome
 Spot; Stahl, schwarz, chrom
 spot; acier, noir, chrome

L 460, B 70



GU10



3x 4,5W



3x
 warm
 WHITE
 345 lm

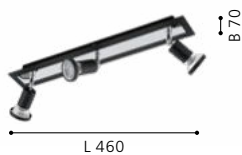

DESIGN
 HIGHLIGHT
 DETAIL



CORBERA

Designer spot series with special spot heads.

Spotserie mit Spotköpfen in besonderem Design.

Série de spot avec des têtes de spot spéciales.

93672 CORBERA

spot; steel, plastic, chrome
Spot; Stahl, Kunststoff, chrom
spot; acier, plastique, chrome

L 120, B 60

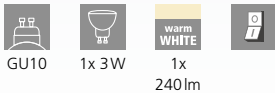

93673 CORBERA

spot; steel, plastic, chrome
Spot; Stahl, Kunststoff, chrom
spot; acier, plastique, chrome

L 390, B 70

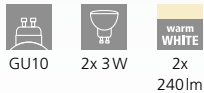

93674 CORBERA

spot; steel, plastic, chrome
Spot; Stahl, Kunststoff, chrom
spot; acier, plastique, chrome

L 585, B 70

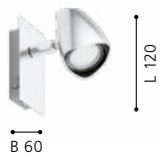
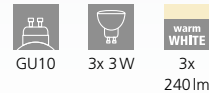



93674

LED

DESIGN
HIGHLIGHT
DETAIL

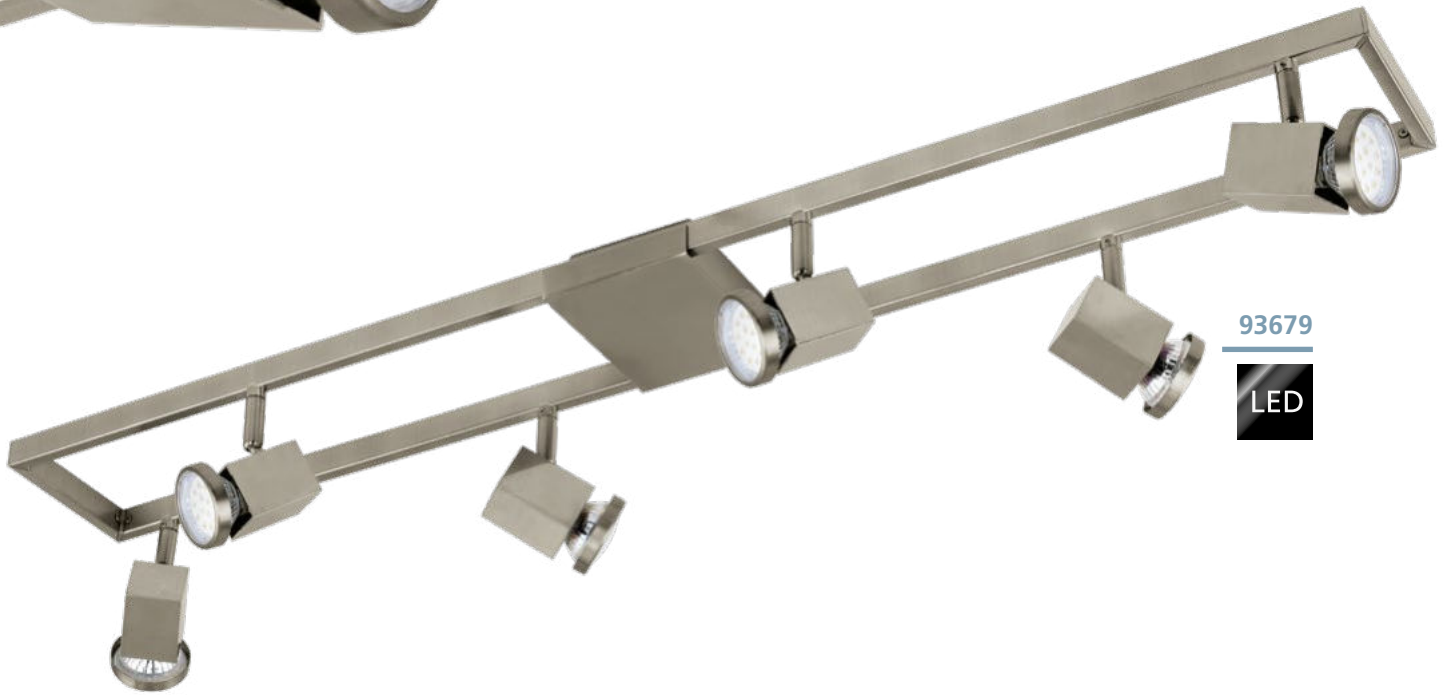



93679
LED

93679 ZERACO

spot; steel, plastic, satin nickel
Spot; Stahl, Kunststoff, nickel-matt
spot; acier, plastique, nickel mat

L 940, B 120

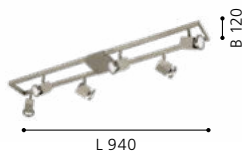

		
GU10	6x 5W	6x warm WHITE 400lm



93678 ZERACO

spot; steel, plastic, satin nickel
Spot; Stahl, Kunststoff, nickel-matt
spot; acier, plastique, nickel mat

L 700, B 120

		
GU10	4x 5W	4x warm WHITE 400lm





93678

LED



94145 TUKON 3

spot; steel, satin nickel
Spot; Stahl, nickel-matt
spot; acier, nickel mat

L 280, B 70

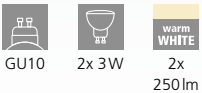

94146 TUKON 3

spot; steel, satin nickel
Spot; Stahl, nickel-matt
spot; acier, nickel mat

L 460, B 70

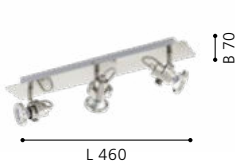
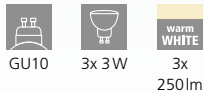

94144 TUKON 3

spot; steel, satin nickel
Spot; Stahl, nickel-matt
spot; acier, nickel mat

L 165, B 70

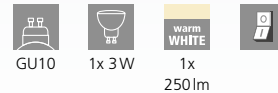



94144

LED



90915

LED



90914

LED



90916

LED



90915 ROTTELO

spot; steel, satin nickel, chrome
Spot; Stahl, nickel-matt, chrom
spot; acier, nickel mat, chrome

L 280, B 70



GU10



2x 5W



warm
WHITE

2x
400lm

90914 ROTTELO

spot; steel, satin nickel, chrome
Spot; Stahl, nickel-matt, chrom
spot; acier, nickel mat, chrome

L 120, B 60



GU10



1x 5W



warm
WHITE

1x
400lm



90916 ROTTELO

spot; steel, satin nickel, chrome
Spot; Stahl, nickel-matt, chrom
spot; acier, nickel mat, chrome

L 260, B 240



GU10



4x 5W



warm
WHITE

4x
400lm



9 002759 909154



L 280



9 002759 909147



B 60

L 120



9 002759 909161



L 260

B 240



90917



90927



90917 ROTTELO

spot; steel, satin nickel, chrome
 Spot; Stahl, nickel-matt, chrom
 spot; acier, nickel mat, chrome

L 780, B 70

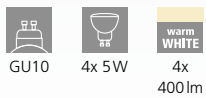

90927 ROTTELO

spot; steel, satin nickel, chrome
 Spot; Stahl, nickel-matt, chrom
 spot; acier, nickel mat, chrome

L 1160, B 70

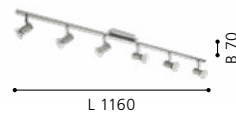
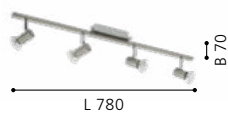
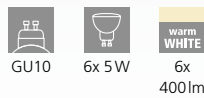





92599 BUZZ-LED

spot; steel, satin nickel
Spot; Stahl, nickel-matt
spot; acier, nickel mat

L 1050, B 65



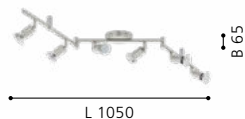





92595 BUZZ-LED

spot; steel, satin nickel
Spot; Stahl, nickel-matt
spot; acier, nickel mat

Ø 60









92596 BUZZ-LED

spot; steel, satin nickel
Spot; Stahl, nickel-matt
spot; acier, nickel mat

L 285, B 65





92597

LED



92598

LED

92597 BUZZ-LED

spot; steel, satin nickel
Spot; Stahl, nickel-matt
spot; acier, nickel mat

L 485, B 65



GU10



3x 3W



3x
warm
WHITE
240lm



9 002759 925970



L 485

B 65

92598 BUZZ-LED

spot; steel, satin nickel
Spot; Stahl, nickel-matt
spot; acier, nickel mat

L 685, B 65



GU10



4x 3W



4x
warm
WHITE
240lm



9 002759 925987



L 685

B 65



92641

LED



92642

LED



92643

LED

92641 MAGNUM-LED

spot; steel, satin nickel, chrome
Spot; Stahl, nickel-matt, chrom
spot; acier, nickel mat, chrome

Ø 70



GU10



1x 3W



1x

240lm



9 002759 926410



92642 MAGNUM-LED

spot; steel, satin nickel, chrome
Spot; Stahl, nickel-matt, chrom
spot; acier, nickel mat, chrome

L 330, B 105



GU10



2x 3W



2x

240lm



9 002759 926427



92643 MAGNUM-LED

spot; steel, satin nickel, chrome
Spot; Stahl, nickel-matt, chrom
spot; acier, nickel mat, chrome

L 255, H 295



GU10



3x 3W



3x

240lm



9 002759 926434





95824

LED



92644

LED



92645

LED

95824 MAGNUM LED

spot; steel, satin nickel, chrome
Spot; Stahl, nickel-matt, chrom
spot; acier, nickel mat, chrome

Ø 180



GU10



3x 3W



3x
warm
WHITE
240lm



9 002759 958244



Ø 180

92644 MAGNUM-LED

spot; steel, satin nickel, chrome
Spot; Stahl, nickel-matt, chrom
spot; acier, nickel mat, chrome

L 645, B 105



GU10



4x 3W



4x
warm
WHITE
240lm



9 002759 926441



L 645

92645 MAGNUM-LED

spot; steel, satin nickel, chrome
Spot; Stahl, nickel-matt, chrom
spot; acier, nickel mat, chrome

L 1050



GU10



6x 3W



6x
warm
WHITE
240lm



9 002759 926458



L 1050



93359

LED



93359



93358



94609

93359 VILANOVA

system; aluminium, steel, aluminium, chrome
 System; Alu, Stahl, alu, chrom
 système; aluminium, acier, aluminium, chrome

L 2000, H 200



GU10



5x 3W



warm
 WHITE
 5x
 240lm



9 002759 933593



INCL.



L 2000

94609 VILANOVA

accessory; steel, satin nickel
 Zubehör; Stahl, nickel-matt
 accessoire; acier, nickel mat

L 395



9 002759 946098



L 395



93358

LED

93358 VILANOVA

system; aluminium, steel, aluminium, chrome / glass, white, clear
 System; Alu, Stahl, alu, chrom / Glas, weiss, klar
 système; aluminium, acier, aluminium, chrome / verre, blanc, clair

L 2000, H 200



GU10



5x 5W



warm
WHITE
5x
400lm



9 002759 933586



INCL.



L 2000

94609

Set to connect two Vilanova (93359, 93358, not suitable for 94418) tracks:

- > 250mm cable
- > 2 end parts
- > 1 straight connector for direct connection

Verbindungsset für 2 Vilanova (93359, 93358, nicht für 94418) Schienen:

- > 250mm Kabel
- > 2 Endstücke
- > 1 Verbinder für eine direkte Verbindung

Set de connexion pour deux rails de Vilanova (93359, 93358, pas 94418):

- > câble de 250mm
- > 2 pièces d'about
- > 1 connecteur pour une connexion directe





93085

LED

DESIGN
HIGHLIGHT
DETAIL

93085 CABO 1

wall / ceiling light; steel, chrome / satin glass, white, clear
Wand- / Deckenleuchte; Stahl, chrom / Glas satiniert, weiss, klar
applique / plafonnier; acier, chrome / verre satiné, blanc, clair

H 100, Ø 290

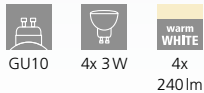

32001 PAWEDO 1

wall / ceiling light; steel, satin nickel, chrome / glass, white, clear
Wand- / Deckenleuchte; Stahl, nickel-matt, chrom / Glas, weiss, klar
applique / plafonnier; acier, nickel mat, chrome / verre, blanc, clair

Ø 290

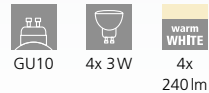

9 002759 930851



Ø 290



9 002759 320010



Ø 290



32001

LED



96182

LED



96178

LED



96179

LED

96182 CARDILLO 1

spot; aluminium, steel, aluminium, chrome / plastic, satiné
Spot; Alu, Stahl, alu, chrom / Kunststoff, satiniert
spot; aluminium, acier, aluminium, chrome / plastique, satiné

96178 CARDILLO 1

spot; aluminium, steel, aluminium, chrome / plastic, satiné
Spot; Alu, Stahl, alu, chrom / Kunststoff, satiniert
spot; aluminium, acier, aluminium, chrome / plastique, satiné

96179 CARDILLO 1

spot; aluminium, steel, aluminium, chrome / plastic, satiné
Spot; Alu, Stahl, alu, chrom / Kunststoff, satiniert
spot; aluminium, acier, aluminium, chrome / plastique, satiné

L 985, B 85

LED	warm WHITE	LED	warm WHITE	
4x 3,2W	4x 400lm	2x 3,3W	2x 360lm	



9 002759 961824



L 225, B 65

LED	warm WHITE	LED	warm WHITE	
1x 3,2W	1x 400lm	1x 2,2W	1x 240lm	



9 002759 961787



L 390, B 85

LED	warm WHITE	LED	warm WHITE	
2x 3,2W	2x 400lm	1x 3,3W	1x 360lm	



9 002759 961794

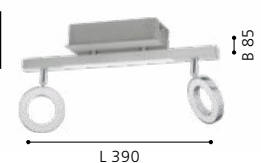



96181



96183



96181 CARDILLIO 1

spot; aluminium, steel, aluminium, chrome / plastic, satiné
 Spot; Alu, Stahl, alu, chrom / Kunststoff, satiniert
 spot; aluminium, acier, aluminium, chrome / plastique, satiné

L 690, B 85

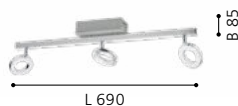
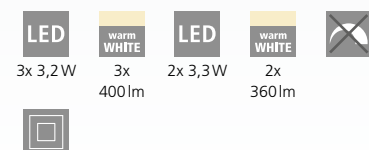

96183 CARDILLIO 1

spot; aluminium, steel, aluminium, chrome / plastic, satiné
 Spot; Alu, Stahl, alu, chrom / Kunststoff, satiniert
 spot; aluminium, acier, aluminium, chrome / plastique, satiné

L 1585, B 85

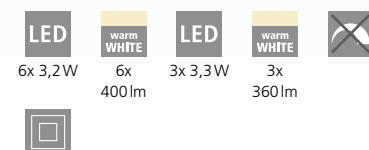

CARDILLIO 1

These luminaires have different lighting sources. Profil lights combined with spot heads create basic lighting as well as accent lighting.

Diese Leuchten verfügen über unterschiedliche Lichtquellen. Profilleuchten kombiniert mit Spotköpfen schaffen sowohl Grundlicht als auch Akzentbeleuchtung.

Ces luminaires ont des sources d'éclairage différentes. La combinaison entre un éclairage sur la base du produit et un spot vous permet d'avoir un éclairage général mais aussi directionnel.



95629

LED



DESIGN
HIGHLIGHT
DETAIL



95629 SALTO

spot; steel, chrome / plastic, satiné
Spot; Stahl, chrom / Kunststoff, satiniert
spot; acier, chrome / plastique, satiné

L 360, B 120

LED

2x 5,4W

warm
WHITE

2x
640lm



9 002759 956295





95628

LED



95631

LED



95632

LED

95628 SALTO

spot; steel, chrome / plastic, satiné
Spot; Stahl, chrom / Kunststoff, satiniert
spot; acier, chrome / plastique, satiné

Ø 110



1x 5,4W

1x
640lm



9 002759 956288



95631 SALTO

spot; steel, chrome / plastic, satiné
Spot; Stahl, chrom / Kunststoff, satiniert
spot; acier, chrome / plastique, satiné

L 560, B 130



3x 5,4W

3x
640lm



9 002759 956318



95632 SALTO

spot; steel, chrome / plastic, satiné
Spot; Stahl, chrom / Kunststoff, satiniert
spot; acier, chrome / plastique, satiné

L 760, B 130



4x 5,4W

4x
640lm



9 002759 956325



CLIP & PLUG LUMINAIRES

KLEMM- & STECKERLEUCHTEN
LUMINAIRES À PINCE & SUR PRISE

LIGHT - VIRTUALLY ANYWHERE -

Our clamping and plug-in luminaires inspire with their flexible uses. They serve as pleasant reading lamps or can be positioned for targeted highlighting.

LICHT - PRAKTISCH ÜBERALL -

Unsere Klemm- und Steckerleuchten begeistern durch ihre flexible Verwendbarkeit. Sie dienen als angenehme Lesebeleuchtung oder können zur gezielten Lichtsetzung positioniert werden.



LA LUMIÈRE - PRATIQUE ET PARTOUT -

Nos luminaires à pinces et à fiches ravissent de leurs possibilités flexibles d'utilisation. Ils servent de lumière agréable pour la lecture ou peuvent être positionnés afin d'offrir une lumière ciblée.



OVERVIEW

CLIP & PLUG LUMINAIRES



DAKAR 3
p. 706



DAKAR 3
p. 706



RICCIO 1
p. 706



CABADO
p. 707



MINI 4
p. 708



MINI 4
p. 708



MINI 4
p. 708



TINEO
p. 710



TINEO
p. 710



TINEO
p. 710



TINEO
p. 711





92935



92932

LED



94329

LED

92935 DAKAR 3

plug light; steel, satin nickel, chrome / plastic, white
Steckerleuchte; Stahl, nickel-matt, chrom / Kunststoff, weiss
luminaire sur prise; acier, nickel mat, chrome / plastique, blanc

L 70, H 180, A 280



E14



1x 25W



4



9 002759 929350



92932 DAKAR 3

clamp light; plastic, steel, silver, chrome / plastic, white
Klemmleuchte; Kunststoff, Stahl, silber, chrom / Kunststoff, weiss
luminaire à pince; plastique, acier, argent, chrome / plastique, blanc

L 245, H 260



E14



1x 4W



1x
warm
WHITE
320lm



4



9 002759 929329

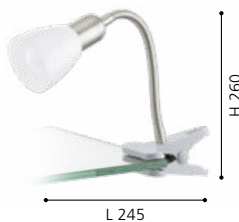

94329 RICCIO 1

clamp light; plastic, steel, white, chrome / steel, white, chrome
Klemmleuchte; Kunststoff, Stahl, weiss, chrom / Stahl, weiss, chrom
luminaire à pince; plastique, acier, blanc, chrome / acier, blanc, chrome

L 180, H 330



GU10



1x 3W



1x
warm
WHITE
240lm



4



9 002759 943295

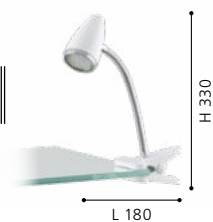



97077

LED

97077 CABADO

clamp light; plastic, white
Klemmleuchte; Kunststoff, weiss
luminaire à pince; plastique, blanc

L 120, B 65, H 420

LED

3W

warm
WHITE

80lm



ACCU

Li-ion



500mAh



9 002759 970772

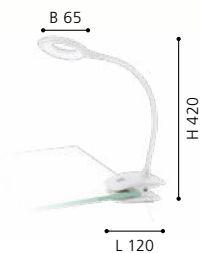



92925

LED



92924

LED

92925 MINI 4

plug light; steel, white, chrome
Steckerleuchte; Stahl, weiss, chrom
luminaire sur prise; acier, blanc, chrome

L 70, H 100

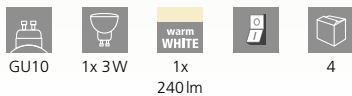

92924 MINI 4

plug light; steel, satin nickel, chrome
Steckerleuchte; Stahl, nickel-matt, chrom
luminaire sur prise; acier, nickel mat, chrome

L 70, H 100



92933 MINI 4

plug light; steel, satin nickel, chrome
Steckerleuchte; Stahl, nickel-matt, chrom
luminaire sur prise; acier, nickel mat, chrome

L 70, H 180, A 220





92933

LED



97933



97932



97935



97932 TINEO

plug light; plastic, white
Steckerleuchte; Kunststoff, weiss
luminaire sur prise; plastique, blanc

H 60, Ø 55



0,4W 2lm 10



H 60



Ø 55



9 002759 979324

97933 TINEO

plug light; plastic, white
Steckerleuchte; Kunststoff, weiss
luminaire sur prise; plastique, blanc

H 85, Ø 55



0,26W 3lm 10



H 85



Ø 55



9 002759 979331

97935 TINEO

plug light; plastic, white
Steckerleuchte; Kunststoff, weiss
luminaire sur prise; plastique, blanc

L 85, B 60, H 65



0,3W 5lm 10



L 85



B 60



9 002759 979355



97934

This luminaire is equipped with a voice sensor. If an acoustic signal reaches an intensity of 60 dB, the night light will switch on automatically.

Diese Leuchte ist mit einem Akustiksensoren ausgestattet. Bei einem akustischen Signal ab 60 dB schaltet sich das Nachtlicht automatisch ein.

Cette lumière est équipée d'un capteur acoustique. A un signal acoustique dès 60 dezi Bell, la lumière de nuit s'intervient automatiquement.



97934



97934 TINEO

plug light; plastic, white
Steckerleuchte; Kunststoff, weiss
luminaire sur prise; plastique, blanc

L 90, B 70, H 90



97932, 97933, 97934, 97935

Automatic illumination. This photo-electric lighting controller automatically switches light 'ON' at dusk and automatically 'OFF' again at dawn.

Automatische Beleuchtung. Der Day & Night Sensor schaltet bei Dämmerung automatisch Licht AN und am Morgen automatisch wieder AUS.

Éclairage automatique. L'interrupteur crépusculaire allume automatiquement la lumière au crépuscule et l'éteint automatiquement à l'aube.

TABLE & FLOOR LUMINAIRES

TISCH- & STEHLEUCHTEN

LUMINAIRES DE TABLE & LAMPADAIRES

WE LOVE LIGHT -

The range of table and floor luminaires is made up of many different styles and convinces with its diverse uses. The luminaires give your home a comfortable light mood and turn into chic living room accessories.

WIR STEHEN AUF LICHT -

Das Sortiment der Tisch- und Stehleuchten setzt sich aus unterschiedlichen Stilen zusammen und überzeugt mit seinen vielseitigen Einsatzmöglichkeiten. Die Leuchten verleihen Ihrem Zuhause eine gemütliche Lichtstimmung und werden zum schicken Wohnraumaccessoire.

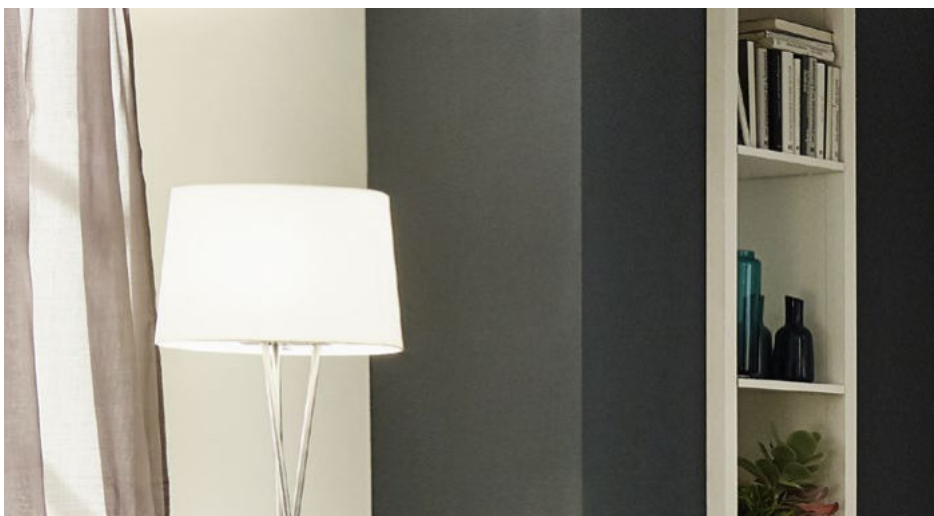

















































NOUS NOUS TENONS EN PLEINE LUMIÈRE -

La gamme de luminaires de table et lampadaires est formée de différents styles et persuade par ses multiples possibilités d'application. Les lampes donnent à votre intérieur une lumière conviviale et se transforment en des accessoires d'habitat chics.



OVERVIEW

TABLE & FLOOR LUMINAIRES

 FONDACHELLI p. 716	 SCIGLIATI p. 716	 ESTAZIONA p. 717	 NOSINO p. 717	 CONESA p. 718	 SANTANDER p. 719	 ESPARTAL p. 719	 NADINA p. 719
 TERRIENTE p. 720	 REKALDE p. 720	 PICACHA p. 720	 CARBONERAS p. 721	 BUDENSEA p. 721	 BARBOTTO p. 722	 DARNIUS p. 722	 BORGILLO p. 723
 UP 2 p. 724-725	 BAYA LED p. 726-727	 SARRIONE p. 728	 BAYA p. 729	 VILLABATE 1 p. 730-731	 PASTERI p. 731	 PEDREGAL 1 p. 732	 CARLTON 2 p. 733
 CHIETINO 1 p. 734	 LIDSING p. 734	 MANALBA 1 p. 735	 MANALBA p. 735	 TRONDIO p. 736	 BELLARIVA 3 p. 736	 BELLARIVA p. 736-737	 MATARO 1 p. 738
 MATARO p. 738	 CAHUAMA p. 738-739	 SWARBY p. 740	 CERCAMAR p. 741	 PETTO 1 p. 741	 MAMBLAS p. 741	 AMEZAGA p. 742	 ERMUA p. 743
 CASTELLATO p. 743	 OLIVAL 1 p. 743	 SOLO 1 p. 744	 SOLO p. 745	 SLIM p. 745	 DAMASCO 1 p. 745, 746	 GEO p. 747	 NARANJO p. 749
 DESIERTO p. 749							



This product is available in different colors and shapes./ Dieser Artikel ist in unterschiedlichen Farben und Formen verfügbar.
Cet article est disponible en différentes couleurs et formes.





95539



95541



98391

95539 FONDACHELLI

floor light; steel, satin nickel / fabric, white, silver
 Stehleuchte; Stahl, nickel-matt / Textil, weiss, silber
 lampadaire; acier, nickel mat / tissu, blanc, argent

H 1515, Ø 510



E27 1x 60W



9 002759 955397



95541 FONDACHELLI

floor light; steel, black / fabric, black, copper
 Stehleuchte; Stahl, schwarz / Textil, schwarz, kupfer
 lampadaire; acier, noir / tissu, noir, cuivre

H 1515, Ø 510

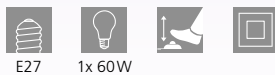

E27 1x 60W



9 002759 955410



98391 SCIGLIATI

floor light; steel, black / fabric, black, gold
 Stehleuchte; Stahl, schwarz / Textil, schwarz, gold
 lampadaire; acier, noir / tissu, noir, or

H 1440, Ø 340, Base: Ø 645

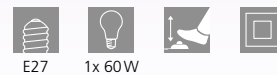

E27 1x 60W



9 002759 983918

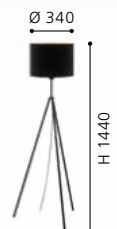



99015

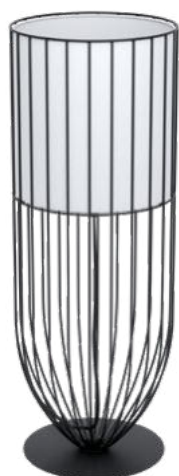

99101



99102

99015 ESTAZIONA

floor light; steel, black / fabric, black
 Stehleuchte; Stahl, schwarz / Textil, schwarz
 lampadaire; acier, noir / tissu, noir

L 260, B 235, H 1500, Base: Ø 245

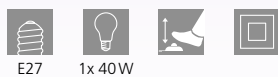

E27 1x 40W



9 002759 990152

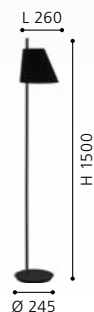

99101 NOSINO

table light; steel, black / fabric, white
 Tischleuchte; Stahl, schwarz / Textil, weiss
 luminaire de table; acier, noir / tissu, blanc

H 580, Ø 220, Base: Ø 220

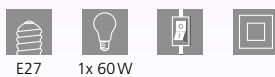

E27 1x 60W



9 002759 991012



99102 NOSINO

floor light; steel, black / fabric, white
 Stehleuchte; Stahl, schwarz / Textil, weiss
 lampadaire; acier, noir / tissu, blanc

H 1310, Ø 250, Base: Ø 250

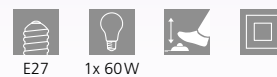

E27 1x 60W



9 002759 991029

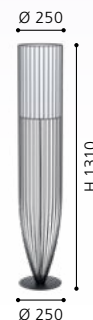



95686

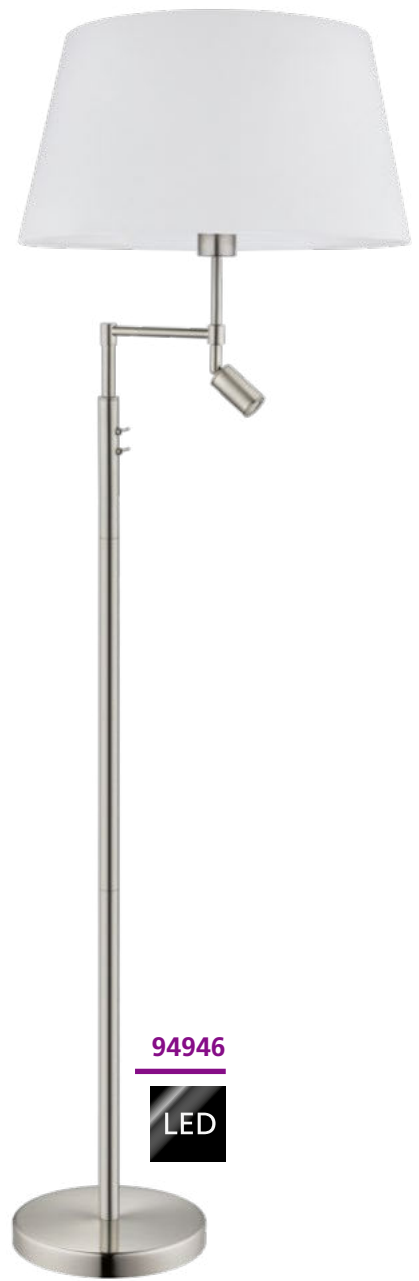

94946

LED

95686 CONESA

floor light; steel, satin nickel / fabric, glass, white
 Stehleuchte; Stahl, nickel-matt / Textil, Glas, weiss
 lampadaire; acier, nickel mat / tissu, verre, blanc

H 1700, Ø 380, Base: Ø 230



E27



1x 60W



E14



1x 40W



9 002759 956868



98309

This luminaire can be switched separately with a pull switch.

Diese Leuchte ist separat mit Zugschalter schaltbar.

Ce luminaire peut être commuté séparément à l'aide d'un interrupteur à tirette.



98309

LED



92206

94946 SANTANDER

floor light; steel, satin nickel / fabric, white
Stehleuchte; Stahl, nickel-matt / Textil, weiss
lampadaire; acier, nickel mat / tissu, blanc

H 1530, Ø 500, Base: Ø 250



E27



1x 60W



1x 2,1W



warm
WHITE
1x
250lm



9 002759 949464



98309 ESPARTAL

floor light; steel, aluminium, satin nickel, aluminium / fabric, white
Stehleuchte; Stahl, Alu, nickel-matt, alu / Textil, weiss
lampadaire; acier, aluminium, nickel mat, aluminium / tissu, blanc

H 1485, Ø 250, Base: Ø 250



E27



1x 60W



11,8W



warm
WHITE
1550lm



9 002759 983093



92206 NADINA

floor light; steel, satin nickel / fabric with hoop-and-loop tape, white
Stehleuchte; Stahl, nickel-matt / Textil mit Klettverschluss, weiss
lampadaire; acier, nickel mat / tissu avec fermeture velcro, blanc

L 1790, B 380, H 1950, Base: Ø 320



E27



1x 60W



9 002759 922061





98453

98453



98674



99715



98453 TERRIENTE

floor light; steel, black / glass vaporized, black-transparent
 Stehleuchte; Stahl, schwarz / Glas bedampft, schwarz-transparent
 lampadaire; acier, noir / verre vaporisé, noir transparent

H 1500, Base: Ø 260



9 002759 984533

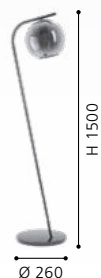

98674 REKALDE

floor light; steel, black, white
 Stehleuchte; Stahl, schwarz, weiss
 lampadaire; acier, noir, blanc

L 290, B 160, H 1500, Base: Ø 250



9 002759 986742



99715 PICACHA

floor light; steel, black / plastic, white
 Stehleuchte; Stahl, schwarz / Kunststoff, weiss
 lampadaire; acier, noir / plastique, blanc

H 1625, Base: B 150, T 150



9 002759 997151





99822

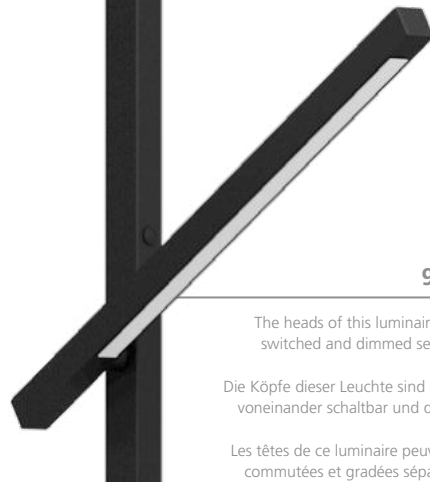

99882

The heads of this luminaire can be switched and dimmed separately.
 Die Köpfe dieser Leuchte sind getrennt voneinander schaltbar und dimmbar.
 Les têtes de ce luminaire peuvent être commutées et gradées séparément.



99113

This lamp is rotatable.
 Diese Leuchte ist drehbar.
 Cette lampe est rotative.

0-180°

0-80°



99113



99822 CARBONERAS

floor light; steel, black / plastic, transparent
 Stehleuchte; Stahl, schwarz / Kunststoff, transparent
 lampadaire; acier, noir / plastique, transparent

L 400, B 250, H 1800, Base: B 330, T 240

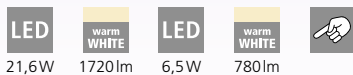

21,6W 1720lm 6,5W 780lm



9 002759 998226

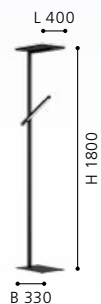

99113 BUDENSEA

floor light; cast aluminium, black, white
 Stehleuchte; Aluguss, schwarz, weiss
 lampadaire; fonte d'aluminium, noir, blanc

L 365, B 250, H 1800

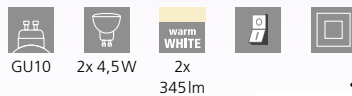

2x 4,5W 2x 345lm



9 002759 991135





97583

LED



97584

LED



98458

97583 BARBOTTO

table light; steel, black, gold
Tischleuchte; Stahl, schwarz, gold
luminaire de table; acier, noir, or

H 395, Ø 60, Base: Ø 100

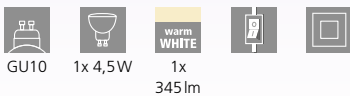

GU10 1x 4,5W 1x 345lm



9 002759 975838



97584 BARBOTTO

floor light; steel, black, gold
Stehleuchte; Stahl, schwarz, gold
lampadaire; acier, noir, or

H 1370, Ø 60, Base: Ø 185

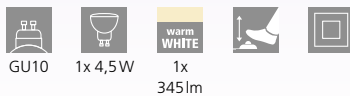

GU10 1x 4,5W 1x 345lm



9 002759 975845



98458 DARNIUS

floor light; steel, black, gold
Stehleuchte; Stahl, schwarz, gold
lampadaire; acier, noir, or

H 1420, Ø 380, Base: Ø 645



E27 1x 40W



9 002759 984588

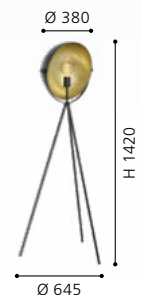

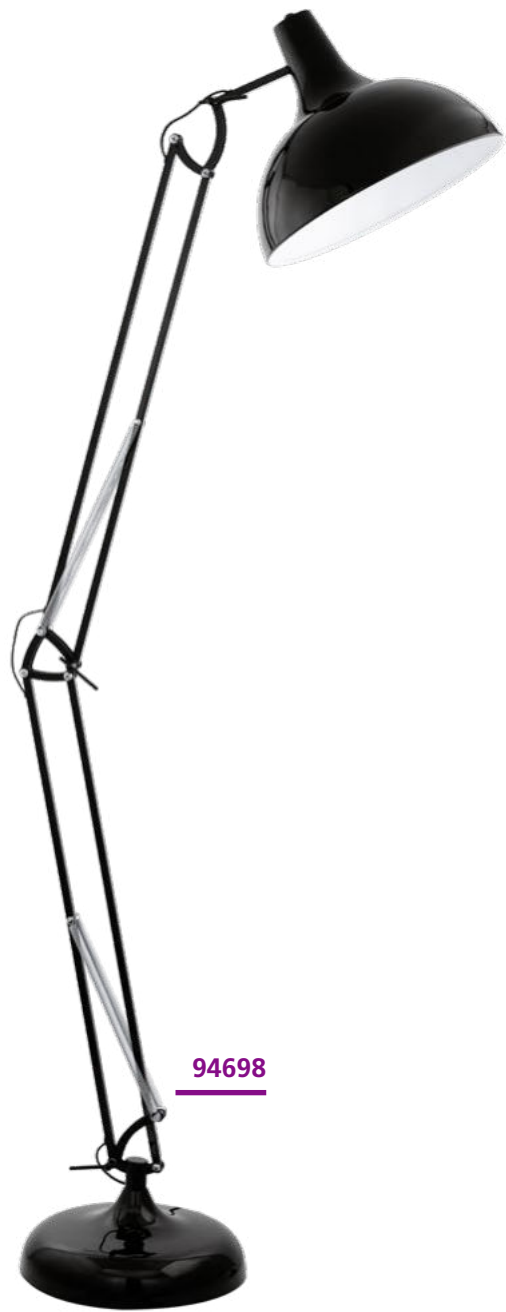

94698



94705

94698 BORGILLIO

floor light; steel, black
 Stehleuchte; Stahl, schwarz
 lampadaire; acier, noir

L 380, H 1900, Base: Ø 340

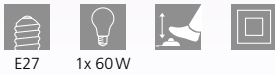

E27 1x 60W



9 002759 946982

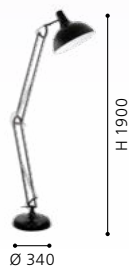

H 1900

Ø 340

94705 BORGILLIO

floor light; steel, copper
 Stehleuchte; Stahl, kupfer
 lampadaire; acier, cuivre

L 380, H 1900, Base: Ø 340

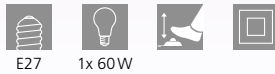

E27 1x 60W



9 002759 947057

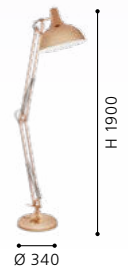

H 1900

Ø 340



93917



82842

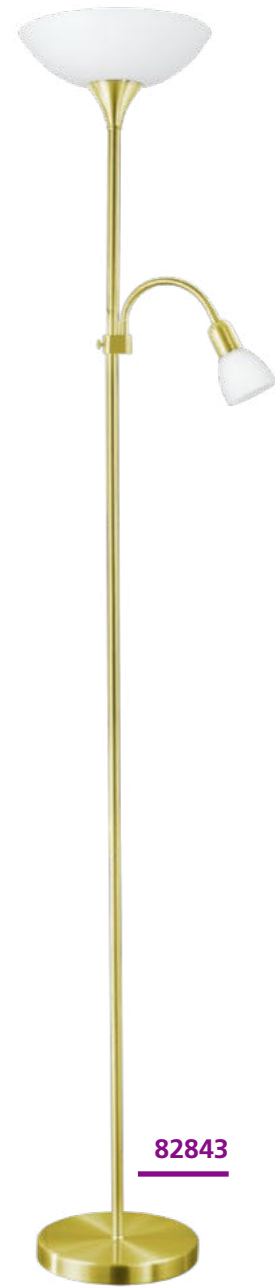

82843

93917 UP 2

floor light; steel, nickel-nero / plastic, glass, white
 Stehleuchte; Stahl, nickel-nero / Kunststoff, Glas, weiss
 lampadaire; acier, nickel noir / plastique, verre, blanc

H 1765, Ø 275, Base: Ø 230

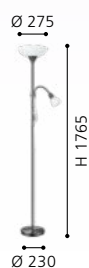
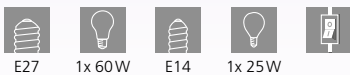

82842 UP 2

floor light; steel, satin nickel / plastic, glass, white
 Stehleuchte; Stahl, nickel-matt / Kunststoff, Glas, weiss
 lampadaire; acier, nickel mat / plastique, verre, blanc

H 1765, Ø 275, Base: Ø 230



82843 UP 2

floor light; steel, brass-matt / plastic, glass, white
 Stehleuchte; Stahl, messing-matt / Kunststoff, Glas, weiss
 lampadaire; acier, laiton mat / plastique, verre, blanc

H 1765, Ø 275, Base: Ø 230

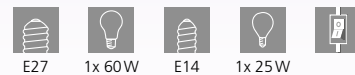



82844

DESIGN
HIGHLIGHT
DETAIL



82844 UP 2

floor light; steel, bronzed / plastic, glass, white
Stehleuchte; Stahl, brüniert / Kunststoff, Glas, weiss
lampadaire; acier, bruni / plastique, verre, blanc

H 1765, Ø 275, Base: Ø 230



E27



1x 60W



E14



1x 25W



9 002759 828448





93877



93876



93875



93877 BAYA LED

floor light; steel, brass / glass, plastic, white, satiné
 Stehleuchte; Stahl, messing / Glas, Kunststoff, weiss, satiniert
 lampadaire; acier, laiton / verre, plastique, blanc, satiné

L 360, H 1800, Base: Ø 250

LED 20W warm WHITE 1950lm LED 2,5W warm WHITE 240lm LED 2,5W

warm WHITE 250lm



9 002759 938772



93876 BAYA LED

floor light; steel, bronzed / glass, plastic, white, satiné
 Stehleuchte; Stahl, brüniert / Glas, Kunststoff, weiss, satiniert
 lampadaire; acier, bruni / verre, plastique, blanc, satiné

L 360, H 1800, Base: Ø 250

LED 20W warm WHITE 1950lm LED 2,5W warm WHITE 240lm LED 2,5W

warm WHITE 250lm



9 002759 938765



93875 BAYA LED

floor light; steel, chrome / glass, plastic, white, satiné
 Stehleuchte; Stahl, chrom / Glas, Kunststoff, weiss, satiniert
 lampadaire; acier, chrome / verre, plastique, blanc, satiné

L 360, H 1800, Base: Ø 250

LED 20W warm WHITE 1950lm LED 2,5W warm WHITE 240lm LED 2,5W

warm WHITE 250lm



9 002759 938758





DESIGN
HIGHLIGHT
DETAIL











93874

LED

93874 BAYA LED

floor light; steel, satin nickel / glass, plastic, white, satined
Stehleuchte; Stahl, nickel-matt / Glas, Kunststoff, weiss, satiniert
lampadaire; acier, nickel mat / verre, plastique, blanc, satiné

L 360, H 1800, Base: Ø 250

 LED 20W	 warm WHITE 1950lm	 LED 2,5W	 warm WHITE 240lm	 LED 2.5W
 warm WHITE 250lm				

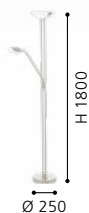



93713

LED

93713 SARRIONE

floor light; steel, satin nickel / plastic, satiné
 Stehleuchte; Stahl, nickel-matt / Kunststoff, satiniert
 lampadaire; acier, nickel mat / plastique, satiné

H 1800, Base: Ø 250

LED	warm WHITE	LED	warm WHITE	LED
17,3W	1600lm	2,9W	270lm	4.5W

warm WHITE	☺	📶	🔄	📐
440lm				

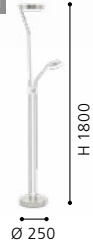



85974 BAYA

floor light; steel, bronzed / satin glass, white
 Stehleuchte; Stahl, brüniert / Glas satiniert, weiss
 lampadaire; acier, bruni / verre satiné, blanc

L 440, H 1800, Base: Ø 280

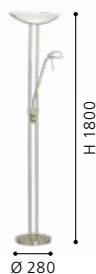

85971 BAYA

floor light; steel, satin nickel / satin glass, white
 Stehleuchte; Stahl, nickel-matt / Glas satiniert, weiss
 lampadaire; acier, nickel mat / verre satiné, blanc

L 440, H 1800, Base: Ø 280





99103

DESIGN
HIGHLIGHT
DETAIL



99103 VILLABATE 1

table light; steel, black / fabric, black, white
Tischleuchte; Stahl, schwarz / Textil, schwarz, weiss
luminaire de table; acier, noir / tissu, noir, blanc

L 185, B 160, H 175



E27



1x 40W



9 002759 991036





99104



95726



95725

99104 VILLABATE 1

table light; steel, satin nickel / fabric, taupe
Tischleuchte; Stahl, nickel-matt / Textil, taupe
luminaire de table; acier, nickel mat / tissu, taupe

L 185, B 160, H 175

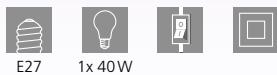

E27 1x 40W



9 002759 991043



95726 PASTERI

table light; steel, satin nickel / fabric, taupe
Tischleuchte; Stahl, nickel-matt / Textil, taupe
luminaire de table; acier, nickel mat / tissu, taupe

H 275, Ø 140, Base: Ø 120

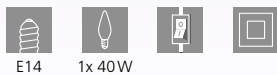

E14 1x 40W



9 002759 957261



95725 PASTERI

table light; steel, satin nickel / fabric, white
Tischleuchte; Stahl, nickel-matt / Textil, weiss
luminaire de table; acier, nickel mat / tissu, blanc

H 275, Ø 140, Base: Ø 120



E14 1x 40W



9 002759 957254





95185

95185 PEDREGAL 1

table light; steel, copper / fabric, black, copper
Tischleuchte; Stahl, kupfer / Textil, schwarz, kupfer
luminaire de table; acier, cuivre / tissu, noir, cuivre

H 645, Ø 350



E27



1x 60W





95789



95787



95788

95789 CARLTON 2

table light; steel, black / fabric, white
Tischleuchte; Stahl, schwarz / Textil, weiss
luminaire de table; acier, noir / tissu, blanc

H 305, Ø 165

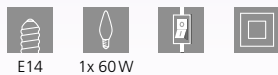

E14 1x 60W



9 002759 957896



95787 CARLTON 2

table light; steel, copper / fabric, black, copper
Tischleuchte; Stahl, kupfer / Textil, schwarz, kupfer
luminaire de table; acier, cuivre / tissu, noir, cuivre

H 305, Ø 165



E14 1x 60W



9 002759 957872

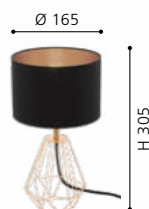

95788 CARLTON 2

table light; steel, brass / fabric, black, gold
Tischleuchte; Stahl, messing / Textil, schwarz, gold
luminaire de table; acier, laiton / tissu, noir, or

H 305, Ø 165



E14 1x 60W



9 002759 957889

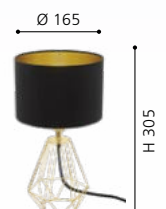



97516



99289



97516 CHIETINO 1

table light; wood, steel, natural, chrome / fabric, white
 Tischleuchte; Holz, Stahl, natur, chrom / Textil, weiss
 luminaire de table; bois, acier, nature, chrome / tissu, blanc

H 440, Ø 260, Base: B 235, T 235



E27 1x 60W



99289

Deoration not included in delivery.

Dekoration im Lieferumfang nicht enthalten.

Décoration non incluse dans la livraison.

99289 LIDSING

table light; steel, glass, chrome, clear / fabric, grey
 Tischleuchte; Stahl, Glas, chrom, klar / Textil, grau
 luminaire de table; acier, verre, chrome, clair / tissu, gris

H 480, Ø 240, Base: Ø 115



E27 1x 40W





99329



99331



95386

99329 MANALBA 1

table light; ceramic, silver / fabric, white, silver
Tischleuchte; Keramik, silber / Textil, weiss, silber
luminaire de table; céramique, argent / tissu, blanc, argent

H 300, Ø 200, Base: Ø 125



E14 1x 40W



9 002759 993290



99331 MANALBA 1

table light; ceramic, gold-coloured / fabric, black, gold
Tischleuchte; Keramik, goldfarben / Textil, schwarz, gold
luminaire de table; céramique, doré / tissu, noir, or

H 300, Ø 200, Base: Ø 125



E14 1x 40W



9 002759 993313



95386 MANALBA

table light; steel, gold / fabric, black, gold
Tischleuchte; Stahl, gold / Textil, schwarz, gold
luminaire de table; acier, or / tissu, noir, or

H 380, Ø 250

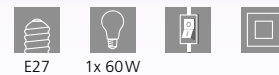

E27 1x 60W



9 002759 953867





93046



99332



97773

93046 TRONDIO

table light; ceramic, white / fabric, white
Tischleuchte; Keramik, weiss / Textil, weiss
luminaire de table; céramique, blanc / tissu, blanc

H 270, Ø 150, Base: Ø 120



E14 1x 40W



9 002759 930462



99332 BELLARIVA 3

table light; ceramic, white / fabric, linen, light brown
Tischleuchte; Keramik, weiss / Textil, Leinen, hellbraun
luminaire de table; céramique, blanc / tissu, lin, marron clair

H 360, Ø 200, Base: Ø 160



E27 1x 40W



9 002759 993320



97773 BELLARIVA

table light; ceramic, creme-white / fabric, white
Tischleuchte; Keramik, creme-weiss / Textil, weiss
luminaire de table; céramique, blanc crème / tissu, blanc

H 320, Ø 150, Base: Ø 120



E14 1x 40W



9 002759 977733





97774

97774 BELLARIVA

table light; ceramic, grey / fabric, white
Tischleuchte; Keramik, grau / Textil, weiss
luminaire de table; céramique, gris / tissu, blanc

H 320, Ø 150, Base: Ø 120



E14



1x 40W



9 002759 977740



DESIGN
HIGHLIGHT
DETAIL



99333



93044



99825

99333 MATARO 1

table light; ceramic, black / fabric, white
Tischleuchte; Keramik, schwarz / Textil, weiss
luminaire de table; céramique, noir / tissu, blanc

L 130, B 110, H 300, Base: B 105, T 85



E14 1x 40W

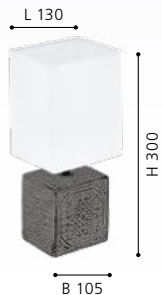

9 002759 993337

93044 MATARO

table light; ceramic, grey / fabric, white
Tischleuchte; Keramik, grau / Textil, weiss
luminaire de table; céramique, gris / tissu, blanc

L 130, B 130, H 300, Base: B 105, T 85



E14 1x 40W



9 002759 930448

99825 CAHUAMA

table light; ceramic, white, black / glass, grey matt
Tischleuchte; Keramik, weiss, schwarz / Glas, grau matt
luminaire de table; céramique, blanc, noir / verre, gris mat

H 300, Ø 275



E27 1x 40W



9 002759 998257



99824

99824 CAHUAMA

table light; ceramic, light brown / glass, white

Tischleuchte; Keramik, hellbraun / Glas, weiss

luminaire de table; céramique, marron clair / verre, blanc

H 300, Ø 275



E27



1x 40W



9 002759 998240

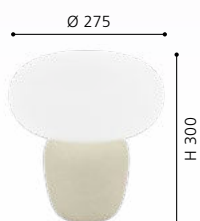

DESIGN
HIGHLIGHT
DETAIL



98859



99084

98859 SWARBY

table light; cement, grey
Tischleuchte; Zement, grau
luminaire de table; ciment, gris

H 120, Ø 100



E27



1x 60W



9 002759 988593





magnetic

94513

LED



98278

99084 CERCAMAR

table light; glass, clear
Tischleuchte; Glas, klar
luminaire de table; verre, clair

H 120, Ø 110



E27 1x 40W



9 002759 990848



94513 PETTO 1

table light; steel, white
Tischleuchte; Stahl, weiss
luminaire de table; acier, blanc

H 135, Ø 105, Base: Ø 90



GU10 1x 3W 1x 250lm



9 002759 945138



98278 MAMBLAS

table light; wood, steel, brown / plastic, white
Tischleuchte; Holz, Stahl, braun / Kunststoff, weiss
luminaire de table; bois, acier, marron / plastique, blanc

H 310, Ø 200, Base: Ø 105



E27 1x 60W



9 002759 982782





98864

98864 AMEZAGA

table light; steel, black, brass

Tischleuchte; Stahl, schwarz, messing

luminaire de table; acier, noir, laiton

L 355, B 160, H 575, Base: Ø 170



E27



1x 10W





98837

LED



DESIGN
HIGHLIGHT
DETAIL

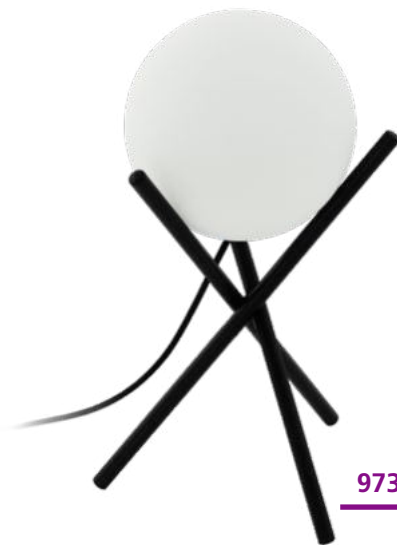

97333



97333



97209



97209

98837 ERMUA

table light; steel, wood, black, brown / plastic, white
Tischleuchte; Stahl, Holz, schwarz, braun / Kunststoff, weiss
luminaire de table; acier, bois, noir, marron / plastique, blanc

L 350, B 165, H 470, Base: B 240, T 160



4,5W 526lm



9 002759 988371



97333 CASTELLATO

table light; steel, black / glass opal-matt, white
Tischleuchte; Stahl, schwarz / Glas opal-matt, weiss
luminaire de table; acier, noir / verre opale mat, blanc

H 330, Ø 210



E14 1x 28W



9 002759 973339



97209 OLIVAL 1

table light; steel, black / smoked glass, black-transparent
Tischleuchte; Stahl, schwarz / Rauchglas, schwarz-transparent
luminaire de table; acier, noir / verre fumé, noir transparent

L 200, B 200, H 305



E27 1x 40W



9 002759 972097





87254



87256



85104

87254 SOLO 1

table light; steel, brass-matt / satin glass, white
Tischleuchte; Stahl, messing-matt / Glas satiniert, weiss
luminaire de table; acier, laiton mat / verre satiné, blanc

H 350, Ø 260, Base: Ø 130

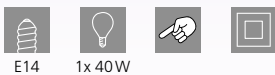

E14 1x 40W



9 002759 872540



87256 SOLO 1

table light; steel, wood, bronzed, nut / satin glass, white
Tischleuchte; Stahl, Holz, brüniert, Nuss / Glas satiniert, weiss
luminaire de table; acier, bois, bruni, noisette / verre satiné, blanc

H 350, Ø 260, Base: Ø 130

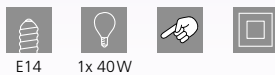

E14 1x 40W



9 002759 872564



85104 SOLO 1

table light; steel, satin nickel / satin glass, white
Tischleuchte; Stahl, nickel-matt / Glas satiniert, weiss
luminaire de table; acier, nickel mat / verre satiné, blanc

H 350, Ø 260, Base: Ø 130

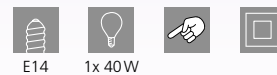

E14 1x 40W



9 002759 851040





91238



95785



95785



82305



82305

91238 SOLO

table light; steel, satin nickel / satin glass, white with decor
Tischleuchte; Stahl, nickel-matt / Glas satiniert, weiss m. Dekor
luminaire de table; acier, nickel mat / verre satiné, blanc avec décor

H 320, Ø 265, Base: Ø 130

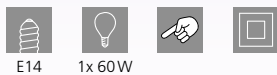

E14 1x 60W



9 002759 912383



95785 DAMASCO 1

table light; steel, satin nickel / glass opal-matt, white
Tischleuchte; Stahl, nickel-matt / Glas opal-matt, weiss
luminaire de table; acier, nickel mat / verre opale mat, blanc

H 300, Ø 145, Base: Ø 120



E14 1x 60W



9 002759 957858



82305 SLIM

table light; steel, satin nickel / glass, white
Tischleuchte; Stahl, nickel-matt / Glas, weiss
luminaire de table; acier, nickel mat / verre, blanc

H 220, Ø 70, Base: Ø 100

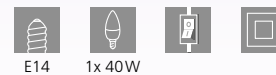

E14 1x 40W



9 002759 823054

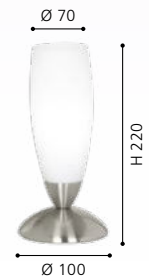



95775 | 95776



95775



95776



98887

95775 DAMASCO 1

table light; steel, satin nickel / satin glass, white
Tischleuchte; Stahl, nickel-matt / Glas satiniert, weiss
luminaire de table; acier, nickel mat / verre satiné, blanc

H 215, Ø 100

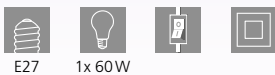

9 002759 957759



95776 DAMASCO 1

table light; steel, chrome / satin glass, white
Tischleuchte; Stahl, chrom / Glas satiniert, weiss
luminaire de table; acier, chrome / verre satiné, blanc

H 215, Ø 100

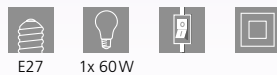

9 002759 957766



98887 DAMASCO 1

table light; steel, black / glass vaporized, black-transparent
Tischleuchte; Stahl, schwarz / Glas bedampft, schwarz-transparent
luminaire de table; acier, noir / verre vaporisé, noir transparent

H 310, Ø 100

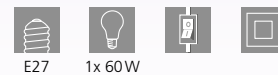

9 002759 988876

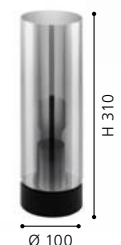



81827 GEO

table light; glass opal-matt, white
Tischleuchte; Glas opal-matt, weiss
luminaire de table; verre opale mat, blanc

H 200, Ø 100, Base: Ø 100

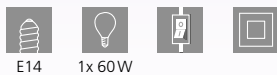

81828 GEO

table light; glass opal-matt, white
Tischleuchte; Glas opal-matt, weiss
luminaire de table; verre opale mat, blanc

H 350, Ø 120, Base: Ø 120

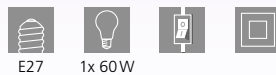

91242 GEO

table light; glass printed, white
Tischleuchte; Glas bedruckt, weiss
luminaire de table; verre imprimé, blanc

H 200, Ø 100

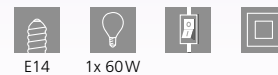



99597

LED

DESIGN
HIGHLIGHT
DETAIL



99794



99597 NARANJO

table light; steel, black / glass, clear
Tischleuchte; Stahl, schwarz / Glas, klar
luminaire de table; acier, noir / verre, clair

L 450, B 430, H 555



4x 4,1 W 1520lm



9 002759 995973

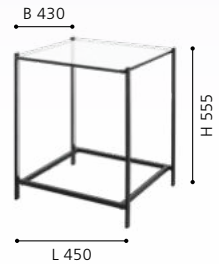

99794 DESIERTO

table light; steel, wood, black, brown
Tischleuchte; Stahl, Holz, schwarz, braun
luminaire de table; acier, bois, noir, marron

H 540, Ø 450

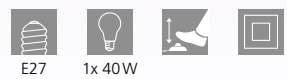

E27 1x 40W



9 002759 997946

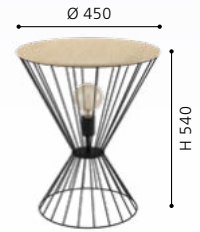

OFFICE TABLE & FLOOR LUMINAIRES

BÜRO TISCH- & STEHLEUCHTEN

LUMINAIRES DE TABLE & LAMPADAIRES À BUREAU

WE LOVE LIGHT -

The range of office table and floor luminaires is made up of many different styles and convinces with its diverse uses.

WIR STEHEN AUF LICHT -

Das Sortiment der Büro Tisch- und Stehleuchten setzt sich aus unterschiedlichen Stilen zusammen und überzeugt mit seinen vielseitigen Einsatzmöglichkeiten.

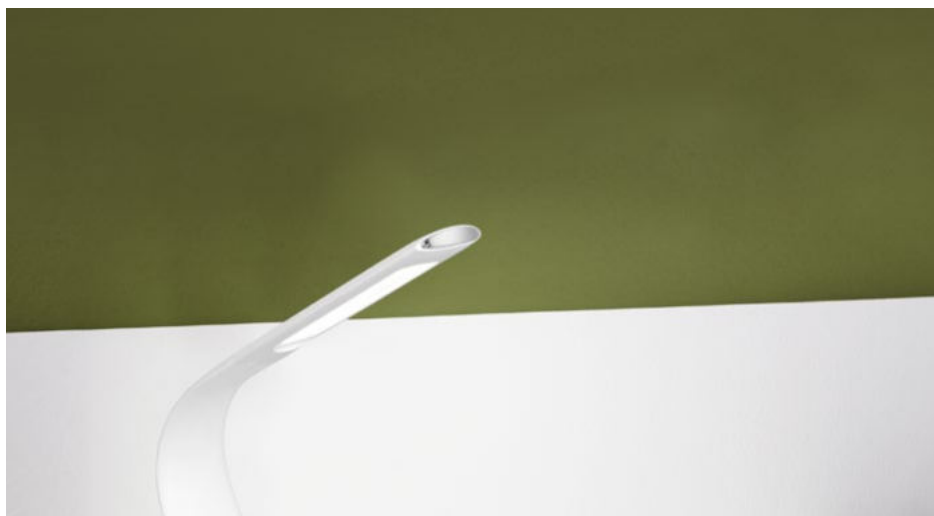





















































NOUS NOUS TENONS EN PLEINE LUMIÈRE -

La gamme d'éclairages de table et sur pieds à bureau est formée de différents styles et persuade par ses multiples possibilités d'application.



OVERVIEW

OFFICE & TABLE LUMINAIRES

 <p>TRUNCA p. 754</p>	 <p>MASSERIE p. 754</p>	 <p>ARENAZA p. 755</p>	 <p>ARENAZA p. 755</p>	 <p>BANDERALO p. 756</p>	 <p>BANDERALO p. 756</p>	 <p>SELLANO p. 756</p>	 <p>LA SECA p. 757</p>
 <p>LA SECA p. 757</p>	 <p>CAUPO p. 758</p>	 <p>CAUPO p. 758</p>	 <p>COGNOLI p. 758</p>	 <p>COGNOLI p. 759</p>	 <p>LAROA p. 760</p>	 <p>LAROA p. 760</p>	 <p>LAROA p. 760</p>
 <p>LAROA p. 761</p>	 <p>LAROA p. 761</p>	 <p>LAROA p. 761</p>	 <p>CEPPINO p. 762</p>	 <p>CEPPINO p. 762</p>	 <p>VERADAL p. 762</p>	 <p>VERADAL p. 763</p>	 <p>DURENGO p. 764</p>
 <p>DAMBERA p. 764</p>	 <p>SNAPORA p. 764</p>	 <p>GEXO p. 766</p>	 <p>GEXO p. 766</p>	 <p>CABALES p. 766</p>	 <p>CABALES p. 767</p>	 <p>CABADO 1 p. 768</p>	 <p>CAJERO p. 768</p>
 <p>CAJERO p. 768</p>	 <p>CAJERO p. 769</p>	 <p>TABILLANO 1 p. 770</p>	 <p>TORONA 1 p. 770</p>	 <p>BORGILLIO p. 772</p>	 <p>BORGILLIO p. 772</p>	 <p>BORGILLIO p. 772</p>	 <p>BORGILLIO p. 773</p>
 <p>BANKER p. 774</p>	 <p>FIRMO p. 775</p>	 <p>FIRMO p. 775</p>	 <p>FIRMO p. 775</p>	 <p>BASIC 1 p. 776</p>	 <p>BASIC p. 776</p>	 <p>BASIC p. 776</p>	 <p>BASIC p. 777</p>
 <p>BASIC p. 777</p>	 <p>PRINCE 1 p. 778</p>	 <p>FOX 1 p. 778</p>	 <p>FOX p. 778</p>	 <p>FOX p. 779</p>	 <p>FABIO p. 779</p>	 <p>FABIO p. 779</p>	





98093, 98247, 99828, 99829

These luminaires have a Qi charging function. They can wirelessly charge Qi-compatible Smartphones by inductive energy transfer.

Diese Leuchten besitzen eine Qi-Ladefunktion. Damit können Qi-kompatible Smartphones über induktive Energieübertragung kabellos geladen werden.

Ces luminaires disposent d'une fonction de chargement Qi. Cela permet aux smartphones compatibles Qi d'être chargés sans fil par transmission d'énergie inductive.



98093

LED



98247

LED

98093 TRUNCA

table light; plastic, white

Tischleuchte; Kunststoff, weiss

luminaire de table; plastique, blanc

H 485, Base: B 185, T 185

LED
3,7W

tunable WHITE
450lm



9 002759 980931



98247 MASSERIE

table light; plastic, white

Tischleuchte; Kunststoff, weiss

luminaire de table; plastique, blanc

H 385, Base: B 165, T 165

LED
3,4W

neutral WHITE
470lm



9 002759 982478





99828

LED



99829

LED



99828 ARENAZA

table light; steel, plastic, white, black
Tischleuchte; Stahl, Kunststoff, weiss, schwarz
luminaire de table; acier, plastique, blanc, noir

L 240, B 130, H 320, Base: B 240, T 120

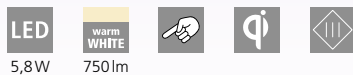

9 002759 998288

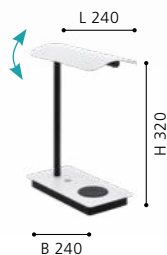

99829 ARENAZA

table light; steel, plastic, black
Tischleuchte; Stahl, Kunststoff, schwarz
luminaire de table; acier, plastique, noir

L 240, B 130, H 320, Base: B 240, T 120

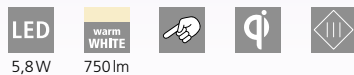

9 002759 998295





99831

LED

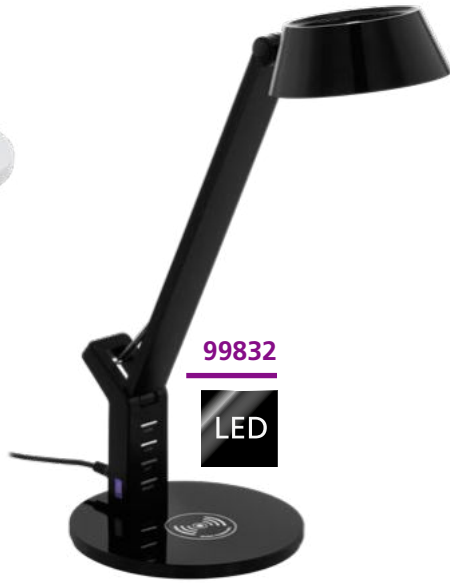

99832

LED



93901

The touch buttons can be used to dim the luminaire and adjust the light colour.

Über die Berührungsschalter kann man die Leuchte dimmen und die Lichtfarbe einstellen.

Les boutons tactiles peuvent être utilisés pour dimmer et régler la couleur de la lumière.



93901

LED

99831 BANDERALO

table light; plastic, white
Tischleuchte; Kunststoff, weiss
luminaire de table; plastique, blanc

L 295, B 170, H 405, Base: Ø 170



4,8W 700lm



99832 BANDERALO

table light; plastic, black
Tischleuchte; Kunststoff, schwarz
luminaire de table; plastique, noir

L 295, B 170, H 405, Base: Ø 170



4,8W 700lm



93901 SELLANO

table light; plastic, steel, white
Tischleuchte; Kunststoff, Stahl, weiss
luminaire de table; plastique, acier, blanc

H 430, Base: B 180, T 180



6W 630lm

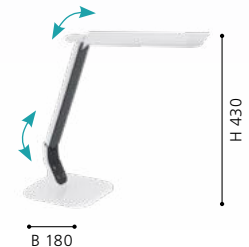

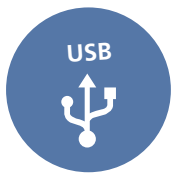

97044

LED

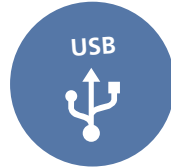

97045

LED



97044, 97045

These luminaires have a USB port for charging and operating the luminaires.

Diese Leuchten verfügen über einen USB-Anschluss, der zum Laden und Betrieb der Leuchten dient.

Faites fonctionner et charger ces luminaires grâce au port USB.

97044 LA SECA

table light; plastic, white
Tischleuchte; Kunststoff, weiss
luminaire de table; plastique, blanc

L 200, B 50, H 260, Base: B 70, T 50



1,8W



170lm



Li-ion



1200mAh



9 002759 970444

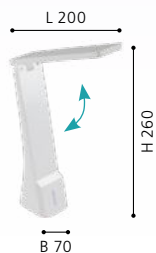

97045 LA SECA

table light; plastic, black
Tischleuchte; Kunststoff, schwarz
luminaire de table; plastique, noir

L 200, B 50, H 260, Base: B 70, T 50



1,8W



170lm



Li-ion



1200mAh



9 002759 970451



DESIGN
HIGHLIGHT
DETAIL



93966

LED



93965

LED



97915

LED

93966 CAUPO

table light; plastic, steel, black
Tischleuchte; Kunststoff, Stahl, schwarz
luminaire de table; plastique, acier, noir

L 260, H 320, Base: B 150, T 150

LED
2,9W

tunable
WHITE
280lm



9 002759 939663

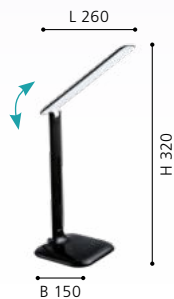

93965 CAUPO

table light; plastic, steel, white
Tischleuchte; Kunststoff, Stahl, weiss
luminaire de table; plastique, acier, blanc

L 260, H 320, Base: B 150, T 150

LED
2,9W

tunable
WHITE
280lm



9 002759 939656



97915 COGNOLI

table light; plastic, white
Tischleuchte; Kunststoff, weiss
luminaire de table; plastique, blanc

L 70, B 100, H 510

LED
3,2W

neutral
WHITE
300lm



9 002759 979157





97914

LED

97914 COGNOLI

table light; plastic, black
 Tischleuchte; Kunststoff, schwarz
 luminaire de table; plastique, noir

L 70, B 100, H 510

LED

3,2W

neutral
 WHITE

300lm



9 002759 979140





96437 LAROA

clamp light; plastic, black
 Klemmleuchte; Kunststoff, schwarz
 luminaire à pince; plastique, noir

L 450, B 65, H 275

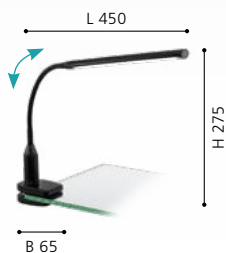

96434 LAROA

clamp light; plastic, white
 Klemmleuchte; Kunststoff, weiss
 luminaire à pince; plastique, blanc

L 450, B 65, H 275

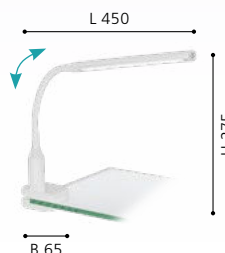

96438 LAROA

table light; plastic, black
 Tischleuchte; Kunststoff, schwarz
 luminaire de table; plastique, noir

L 480, B 120, H 325, Base: B 170, T 120



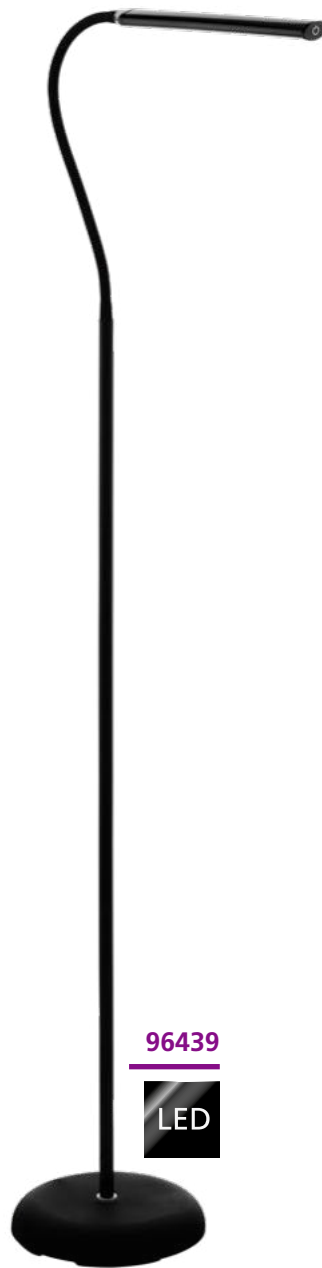

96435 LAROA

table light; plastic, white
Tischleuchte; Kunststoff, weiss
luminaire de table; plastique, blanc

L 480, B 120, H 325, Base: B 170, T 120



9 002759 964351

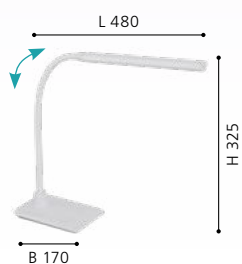

96439 LAROA

floor light; plastic, black
Stehleuchte; Kunststoff, schwarz
lampadaire; plastique, noir

L 535, B 215, H 1300, Base: Ø 210



9 002759 964399



96436 LAROA

floor light; plastic, white
Stehleuchte; Kunststoff, weiss
lampadaire; plastique, blanc

L 535, B 215, H 1300, Base: Ø 210



9 002759 964368

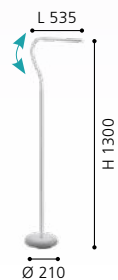

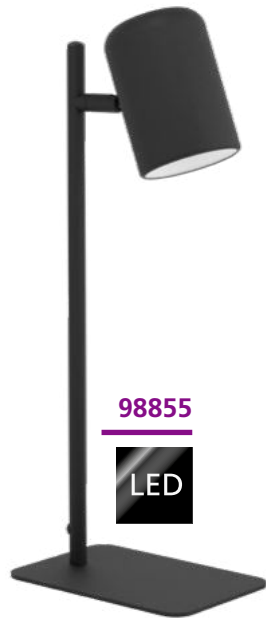

98855

LED



98856

LED

98855 CEPPINO

table light; steel, black, white
Tischleuchte; Stahl, schwarz, weiss
luminaire de table; acier, noir, blanc

H 380, Base: B 165, T 110

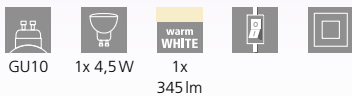

GU10 1x 4,5W 1x 345lm



98856 CEPPINO

table light; steel, white
Tischleuchte; Stahl, weiss
luminaire de table; acier, blanc

H 380, Base: B 165, T 110

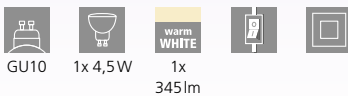

GU10 1x 4,5W 1x 345lm



98832 VERADAL

table light; wood, plastic, white, brown / steel, white
Tischleuchte; Holz, Kunststoff, weiss, braun / Stahl, weiss
luminaire de table; wood, plastic, blanc, marron / acier, blanc

B 125, H 420, Base: Ø 160

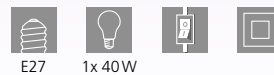

E27 1x 40W





98832



98831 VERADAL

table light; wood, plastic, black, brown / steel, black
 Tischleuchte; Holz, Kunststoff, schwarz, braun / Stahl, schwarz
 luminaire de table; wood, plastic, noir, marron / acier, noir

B 125, H 420, Base: Ø 160



E27



1x 40W



9 002759 988319



98831





93078

LED



94673

LED

93078 DURENGO

table light; plastic, steel, white, chrome
Tischleuchte; Kunststoff, Stahl, weiss, chrom
luminaire de table; plastique, acier, blanc, chrome

H 380, Ø 160, Base: Ø 160

LED

3W

warm
WHITE

230lm



9 002759 930783

94673 DAMBERA

table light; plastic, black
Tischleuchte; Kunststoff, schwarz
luminaire de table; plastique, noir

H 375, Base: Ø 170

LED

4,5W

warm
WHITE

520lm



9 002759 946739

94677 SNAPORA

table light; plastic, aluminium, black
Tischleuchte; Kunststoff, Alu, schwarz
luminaire de table; plastique, aluminium, noir

H 485, Base: Ø 110

LED

3,5W

warm
WHITE

330lm



9 002759 946777



94677

LED



93076

LED



93077

LED



99334

LED

93076 GEXO

table light; plastic, steel, black, chrome
Tischleuchte; Kunststoff, Stahl, schwarz, chrom
luminaire de table; plastique, acier, noir, chrome

H 320, Ø 125, Base: Ø 125

LED

3W

warm WHITE

220lm



9 002759 930769

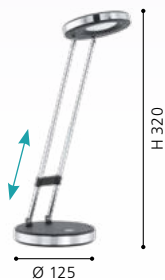

93077 GEXO

table light; plastic, steel, white, chrome
Tischleuchte; Kunststoff, Stahl, weiss, chrom
luminaire de table; plastique, acier, blanc, chrome

H 320, Ø 125, Base: Ø 125

LED

3W

warm WHITE

220lm



9 002759 930776

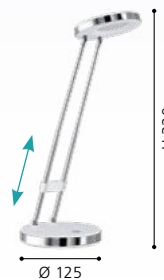

99334 CABLES

table light; plastic, white
Tischleuchte; Kunststoff, weiss
luminaire de table; plastique, blanc

H 340, Ø 140

LED

4,5W

warm WHITE

500lm



9 002759 993344





99335

LED

99335 CBALES

table light; plastic, black
Tischleuchte; Kunststoff, schwarz
luminaire de table; plastique, noir

H 340, Ø 140



4,5W 500lm

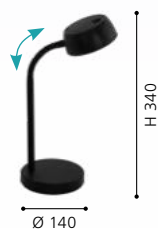



97078

This luminaire has a colored light in the base.
 Diese Leuchte verfügt über ein farbiges Licht im Sockel.
 Cette luminaire a une lumière colorée dans la base.



97078



95695



97078 CABADO 1

table light; plastic, white
 Tischleuchte; Kunststoff, weiss
 luminaire de table; plastique, blanc

L 140, B 110, H 490, Base: B 130, T 105

2,2W
 300lm
 0,3W
 20lm



95695 CAJERO

table light; plastic, white
 Tischleuchte; Kunststoff, weiss
 luminaire de table; plastique, blanc

L 150, B 100, H 500

4,5W
 550lm

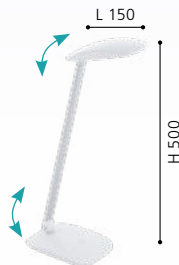

95696 CAJERO

table light; plastic, black
 Tischleuchte; Kunststoff, schwarz
 luminaire de table; plastique, noir

L 150, B 100, H 500

4,5W
 550lm

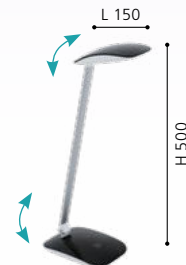



95696

LED



95694

LED

95694 CAJERO

table light; plastic, silver
Tischleuchte; Kunststoff, silber
luminaire de table; plastique, argent

L 150, B 100, H 500

LED

4,5W

neutral
WHITE

550lm

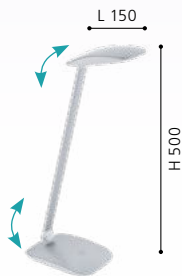

9 002759 956943



DESIGN
HIGHLIGHT
DETAIL



99019

99019 TABILLANO 1

table light; steel, black
Tischleuchte; Stahl, schwarz
luminaire de table; acier, noir

L 560, B 180, H 475, Base: Ø 180



E27 1x 40W



9 002759 990190



96957 TORONA 1

table light; steel, white / wood, natural
Tischleuchte; Stahl, weiss / Holz, natur
luminaire de table; acier, blanc / bois, nature

L 445, B 180, H 605, Base: Ø 180



E14 1x 28W



9 002759 969578





96957



94699



94702

94699 BORGILLIO

table light; steel, white
Tischleuchte; Stahl, weiss
luminaire de table; acier, blanc

L 400, B 190, H 710, Base: Ø 190



E27 1x 40W



9 002759 946999

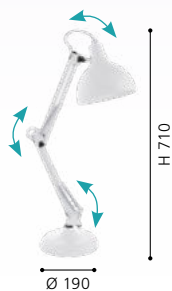

94702 BORGILLIO

table light; steel, chrome
Tischleuchte; Stahl, chrom
luminaire de table; acier, chrome

L 400, B 190, H 710, Base: Ø 190

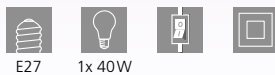

E27 1x 40W



9 002759 947026



94697 BORGILLIO

table light; steel, black
Tischleuchte; Stahl, schwarz
luminaire de table; acier, noir

L 400, B 190, H 710, Base: Ø 190

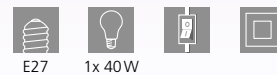

E27 1x 40W



9 002759 946975

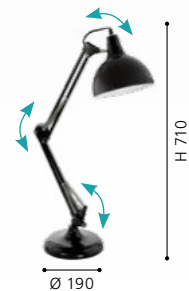



94697



94704

94704 BORGILLIO

table light; steel, copper
Tischleuchte; Stahl, kupfer
luminaire de table; acier, cuivre

L 400, B 190, H 710, Base: Ø 190



E27



1x 40W



9 002759 947040

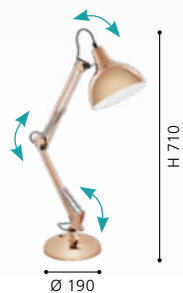



90967



90967

90967 BANKER

table light; steel, brass / glass painted, green
Tischleuchte; Stahl, messing / Glas lackiert, grün
luminaire de table; acier, laiton / verre laqué, vert

L 275, H 390



E27



1x 60W



9 002759 909673



90872, 90873, 90874

These luminaires come with a clip.

Diese Leuchten sind mit einer Klemme ausgestattet.

Ces luminaires viennent avec une pince fixation.



90872 FIRMO

table light; steel, plastic, shiny white

Tischleuchte; Stahl, Kunststoff, weiss glänzend

luminaire de table; acier, plastique, blanc brillant

L 730



E27 1x 40W

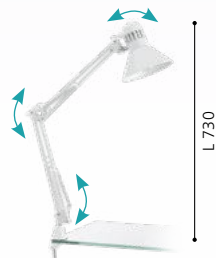

90873 FIRMO

table light; steel, plastic, shiny black

Tischleuchte; Stahl, Kunststoff, schwarz glänzend

luminaire de table; acier, plastique, noir brillant

L 730

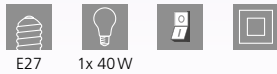

E27 1x 40W



90874 FIRMO

table light; steel, plastic, silver

Tischleuchte; Stahl, Kunststoff, silber

luminaire de table; acier, plastique, argent

L 730

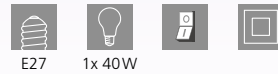

E27 1x 40W

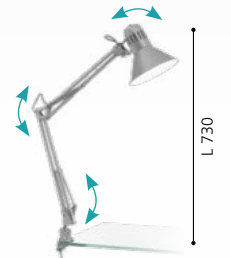



90977



9228



9229

90977 BASIC 1

table light; plastic, steel, silver
Tischleuchte; Kunststoff, Stahl, silber
luminaire de table; plastique, acier, argent

H 300, Base: Ø 125



E27 1x 40W



9 002759 909772



9228 BASIC

table light; plastic, steel, black
Tischleuchte; Kunststoff, Stahl, schwarz
luminaire de table; plastique, acier, noir

H 300, Base: Ø 125



E27 1x 40W



9 002759 922801



9229 BASIC

table light; plastic, steel, white
Tischleuchte; Kunststoff, Stahl, weiss
luminaire de table; plastique, acier, blanc

H 300, Base: Ø 125



E27 1x 40W



9 002759 922900





9230

9232

9230 BASIC

table light; plastic, steel, red
 Tischleuchte; Kunststoff, Stahl, rot
 luminaire de table; plastique, acier, rouge

H 300, Base: Ø 125

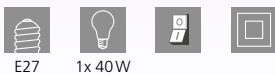

E27 1x 40W



9 002759 923006



9232 BASIC

table light; plastic, steel, blue
 Tischleuchte; Kunststoff, Stahl, blau
 luminaire de table; plastique, acier, bleu

H 300, Base: Ø 125

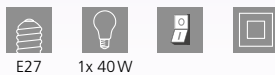

E27 1x 40W



9 002759 923204





86429



86955



92872

LED

86429 PRINCE 1

table light; steel, satin nickel / glass alabaster, white
Tischleuchte; Stahl, nickel-matt / Glas alabaster, weiss
luminaire de table; acier, nickel mat / verre albâtre, blanc

H 370, Base: Ø 125



E14 1x 25W



9 002759 864293



86955 FOX 1

table light; steel, satin nickel, chrome
Tischleuchte; Stahl, nickel-matt, chrom
luminaire de table; acier, nickel mat, chrome

H 330, Base: Ø 123

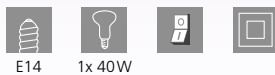

E14 1x 40W



9 002759 869557



92872 FOX

table light; steel, white, chrome
Tischleuchte; Stahl, weiss, chrom
luminaire de table; acier, blanc, chrome

H 320, Base: Ø 125



GU10 1x 3W
warm
WHITE
1x
240lm



9 002759 928728





81262



92873

LED



81265

92873 FOX

table light; steel, anthracite, chrome
Tischleuchte; Stahl, anthrazit, chrom
luminaire de table; acier, anthracite, chrome

H 320, Base: Ø 125

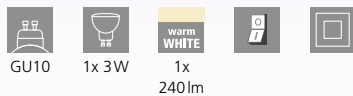

81262 FABIO

clamp light; steel, plastic, white, silver
Klemmleuchte; Stahl, Kunststoff, weiss, silber
luminaire à pince; acier, plastique, blanc, argent

H 300

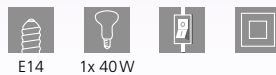

81265 FABIO

clamp light; steel, plastic, silver
Klemmleuchte; Stahl, Kunststoff, silber
luminaire à pince; acier, plastique, argent

H 300

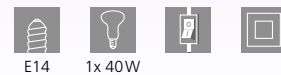

CHILDREN LUMINAIRES

KINDERLEUCHTEN

LUMINAIRES POUR ENFANTS

PLAY OF COLOUR -

The nursery luminaires are characterised by their playful and child-friendly designs. The lovely motives light up in many different colours and turn the nursery into a very special location.

FARBENSPIEL -

Die Kinderzimmerleuchten zeichnen sich durch ihr verspieltes und kindgerechtes Design aus. Die liebevollen Motive erleuchten in unterschiedlichsten Farben und machen das Kinderzimmer zu einem besonderen Ort.



JEU DE COULEUR -

Les éclairages de chambres d'enfants se distinguent de leur design joueur et adapté aux enfants. Les sujets formés avec amour sont illuminés dans des couleurs les plus variées et font de la chambre d'enfant un endroit spécial.





OVERVIEW

CHILDREN LUMINAIRES



SAN CARLO
p. 784



TABARA
p. 784



JUNIOR 1
p. 784



RUFFO
p. 785



VIKI 1
p. 785



VIKI 1
p. 785



97408



97667



87284

97408 SAN CARLO

ceiling light; wood, steel, coloured
Deckenleuchte; Holz, Stahl, bunt
plafonnier; bois, acier, coloré

L 425, B 435, H 80



E27 3x 40W

97667 TABARA

ceiling light; wood, steel, green, white / satin glass, design "soccer"
Deckenleuchte; Holz, Stahl, grün, weiss / Glas satiniert, Motiv Fussball
plafonnier; bois, acier, vert, blanc / verre satiné, motif «football»

H 80, Ø 400



E27 1x 60W

87284 JUNIOR 1

wall / ceiling light; steel, white / satin glass, design "soccer"
Wand- / Deckenleuchte; Stahl, weiss / Glas satiniert, Motiv Fussball
applique / plafonnier; acier, blanc / verre satiné, motif «football»

Ø 245



E27 1x 60W



9 002759 974084



L 425



9 002759 976675



Ø 400



9 002759 872847



Ø 245



97575



97575

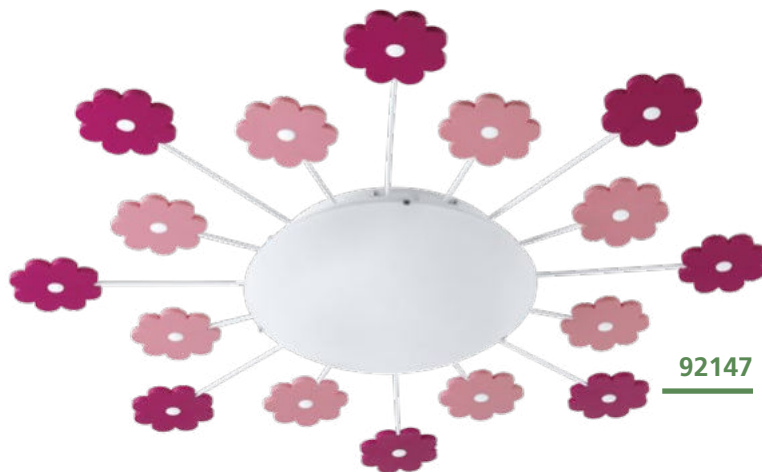

92147



92146

97575 RUFFO

ceiling light; steel, white / fabric, coloured
Deckenleuchte; Stahl, weiss / Textil, bunt
plafonnier; acier, blanc / tissu, coloré

H 110, Ø 380



E27 2x 40W

92146 VIKI 1

wall / ceiling light; steel, blue / satin glass, white
Wand- / Deckenleuchte; Stahl, blau / Glas satiniert, weiss
applique / plafonnier; acier, bleu / verre satiné, blanc

Ø 630, A 80



E27 1x 25W

92147 VIKI 1

wall / ceiling light; steel, pink / satin glass, white
Wand- / Deckenleuchte; Stahl, pink / Glas satiniert, weiss
applique / plafonnier; acier, rose / verre satiné, blanc

Ø 615, A 80



E27 1x 25W



9 002759 975753

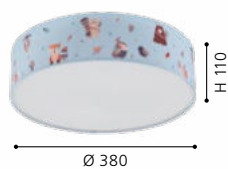

9 002759 921460

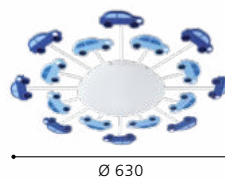

9 002759 921477

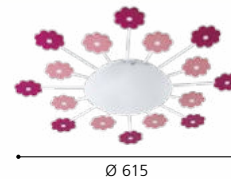

KITCHEN & FUNCTIONAL LUMINAIRES

KÜCHEN- & FUNKTIONSLEUCHTEN

LUMINAIRES FONCTIONNELS & DE CUISINE

YOUR KITCHEN FRIEND -

Our kitchen and function luminaires ensure the right lighting for your workplace and become true supporters. The practical and perfect fitted luminaires ideally refine your kitchen area.

IHR KÜCHENFREUND -

Unsere Küchen- und Funktionsleuchten sorgen für die richtige Beleuchtung Ihrer Arbeitsfläche und werden zur wahren Alltagshilfe. Die praktischen Unterbauleuchten sind die perfekte Ergänzung für Ihren Küchenbereich.



VOTRE AMI DE CUISINE -

Nos lumières fonctionnelles et de cuisine assurent le bon éclairage de votre surface de travail et deviennent une aide parfaite dans le quotidien. Les éclairages de meuble sont l'accompagnement parfait de votre espace de cuisine.

OVERVIEW

KITCHEN & FUNCTIONAL LUMINAIRES



DUNDRY
p. 788



DUNDRY
p. 788



DUNDRY
p. 788

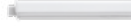

DUNDRY
p. 789



TEYA
p. 790



KOB LED
p. 791



KOB LED
p. 791



BALIOLA
p. 791

DESIGN
HIGHLIGHT
DETAIL



97572 DUNDRY

wall / ceiling light; plastic, white / plastic, white
Wand- / Deckenleuchte; Kunststoff, weiss / Kunststoff, weiss
applique / plafonnier; plastique, blanc / plastique, blanc

L 570, B 25, H 35



97573 DUNDRY

wall / ceiling light; plastic, white / plastic, white
Wand- / Deckenleuchte; Kunststoff, weiss / Kunststoff, weiss
applique / plafonnier; plastique, blanc / plastique, blanc

L 870, B 25, H 35

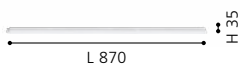

97574 DUNDRY

wall / ceiling light; plastic, white / plastic, white
Wand- / Deckenleuchte; Kunststoff, weiss / Kunststoff, weiss
applique / plafonnier; plastique, blanc / plastique, blanc

L 1170, B 25, H 35

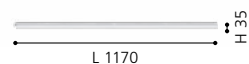



97571

LED

97571 DUNDRY

wall / ceiling light; plastic, white / plastic, white
Wand- / Deckenleuchte; Kunststoff, weiss / Kunststoff, weiss
applique / plafonnier; plastique, blanc / plastique, blanc

L 310, B 25, H 35



3,2W 440lm



9 002759 975715





96081



96081

Mounting type: incl. mounting clips
Switch type: sensor switch (on/off)

Befestigungsart: inkl. Montageclips
Schalterart: Sensor Schalter (ein/aus)

Type de fixation : clips de montage inclus
Type de interrupteur : interrupteur capteur (on/off)

96081 TEYA

under cabinet light; aluminium, silver / plastic, white
Unterbauleuchte; Alu, silber / Kunststoff, weiss
éclairage de meuble; aluminium, argent / plastique, blanc

L 600, B 55, H 25



8,1W



850lm



9 002759 960810

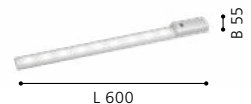



93707

LED

93706

LED

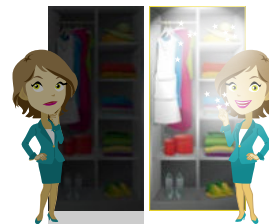

94686

LED



3 m

94686

Incl. battery: yes
 Inkl. sensor: yes
 Switch type: on/off/auto
 Mounting type: incl. adhesive tape
 Moveable LED: no

Incl. Batterie: ja
 Inkl. Sensor: ja
 Schalterart: ein/aus/auto
 Befestigungsart: inkl. Klebeband
 Bewegliche LED: nein

Piles incluses : oui
 Capteur inclus : oui
 Type de interrupteur : marche/arrêt/auto
 Type de fixation : ruban adhésif inclus
 LED réglable : non



93707 KOB LED

under cabinet light; steel, satin nickel
 Unterbauleuchte; Stahl, nickel-matt
 éclairage de meuble; acier, nickel mat

L 600, B 70, H 25



3x 2,3W 780lm



9 002759 937072



93706 KOB LED

under cabinet light; steel, white
 Unterbauleuchte; Stahl, weiss
 éclairage de meuble; acier, blanc

L 600, B 70, H 25



3x 2,3W 780lm



9 002759 937065



94686 BALIOLA

wall light; plastic, silver
 Wandleuchte; Kunststoff, silber
 applique; plastique, argent

L 180, H 46, A 27

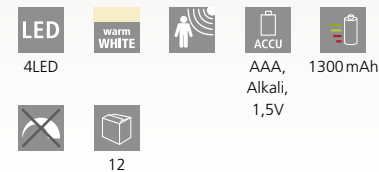

4LED

AAA, Alkali, 1,5V



12



9 002759 946869



ACCESSORIES

ZUBEHÖR
ACCESSOIRES

MAKING IT SPECIAL -

Supplement your personal luminaire range with practical accessories and make your everyday life easier.

DAS GEWISSE EXTRA -

Ergänzen Sie Ihr persönliches Leuchtersortiment mit praktischem Zubehör und erleichtern Sie sich somit Ihren Alltag.



LE PETIT PLUS QUI COMPTE -

Accompagnez votre collection personnelle de lumières par des accessoires pratiques et facilitez-vous ainsi votre quotidien.



92288

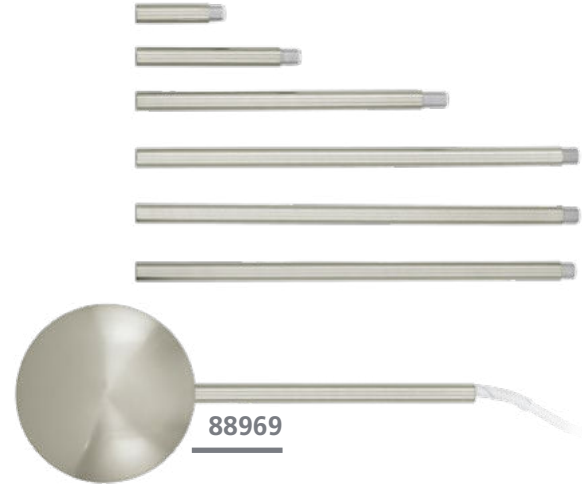

88969

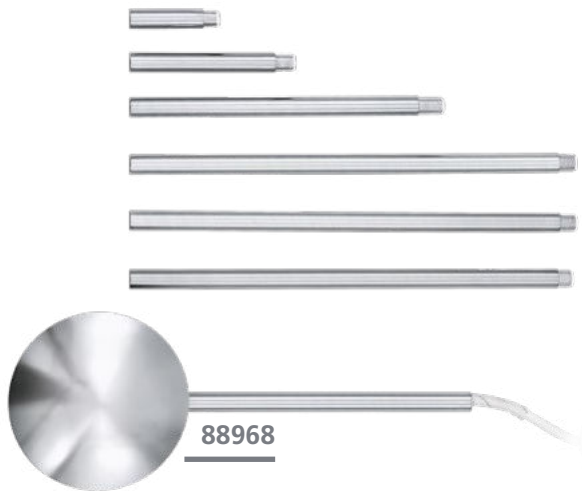

88968



88968, 88969, 92288

Can be extended or shortened from 320 to 1570 mm by screwing in/off the single pieces.

Der Kabelkanal kann durch Ein-/Ausdrehen der Einzelstücke von 320 bis 1570 mm verlängert bzw. verkürzt werden.

Le conduit de câble peut être prolongé ou raccourci en vissent/dévisse les pièces uniques de 320 à 1570 mm.

92288 EXTENTION

accessory; steel, white
Zubehör; Stahl, weiss
accessoire; acier, blanc

L 1570, B 120

88969 EXTENTION

accessory; steel, satin nickel
Zubehör; Stahl, nickel-matt
accessoire; acier, nickel mat

L 1570, B 120

88968 EXTENTION

accessory; steel, chrome
Zubehör; Stahl, chrom
accessoire; acier, chrome

L 1570, B 120

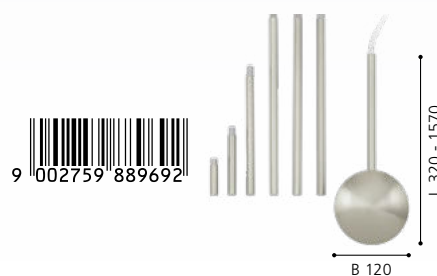



98277, 98279

Turns your single-light luminaire into a three-light one for brighter lighting!

Verwandelt Ihre einflammige Leuchte in eine dreiflammige Lichtquelle für hellere Beleuchtung!

Il transforme votre luminaire à une lumière en une source lumineuse à trois lumières pour un éclairage plus clair!



92348



98277



98279

92348

accessory; plastic, white
Zubehör; Kunststoff, weiss
accessoire; plastique, blanc

L 113, B 44, H 28



10

98277 RUEDA

accessory; plastic, white
Zubehör; Kunststoff, weiss
accessoire; plastique, blanc

H 75, Ø 190



E27

3x 20W

98279 RUEDA

accessory; plastic, black
Zubehör; Kunststoff, schwarz
accessoire; plastique, noir

H 75, Ø 190



E27

3x 20W



9 002759 923488



B 44



9 002759 982775



Ø 190



9 002759 982799



Ø 190



ENERGY EFFICIENCY LABELS

ENERGIEEFFIZIENZ-LABEL

LABEL DE L'EFFICACITÉ ÉNERGÉTIQUE

LED LUMINAIRES -

are increasingly popular and the demand for energy-efficient solutions is gaining strength. This has resulted in the adoption of several EU regulations prescribing the energy efficiency labelling of light sources and luminaires. We have prepared a brief overview of the new energy labels.

LED LEUCHTMITTEL -

sind am Vormarsch, der Ruf nach energieeffizienten Lösungen wird immer größer. In den letzten Jahren wurden daher mehrere EU-Verordnungen verabschiedet, die die Kennzeichnung der Energieeffizienz bei Leuchtmitteln und Leuchten vorschreibt. Hier finden Sie eine kurze Übersicht der neuen Energie-effizienzkennzeichnung.



LES ÉCLAIRAGES LED -

gagnent du terrain, la demande de solutions efficaces en énergie ne cesse de croître. C'est la raison pour laquelle plusieurs directives européennes prescrivant le marquage de l'efficacité énergétique des moyens d'éclairage et des lampes ont été promulguées au cours de ces dernières années. Vous trouverez ici un bref aperçu d'ensemble des nouveaux marquages de l'efficacité énergétique.

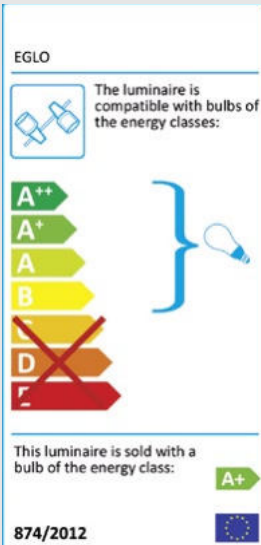

The information in brackets at the centre of the label indicates which bulbs may be used for the luminaire. In this case, the product is only compatible with bulbs with an energy efficiency rating of better than C.

Die Klammer in der Mitte des Labels gibt an, mit welchen Leuchtmitteln die Leuchte kompatibel ist. In diesem Fall dürfen nur Leuchtmittel verwendet werden, deren Energieklasse effizienter als C ist.

La parenthèse au milieu du label indique les moyens d'éclairage avec lesquels la lampe est compatible. Il est seulement permis dans ce cas d'utiliser des moyens d'éclairage dont la classe d'énergie présente une efficacité supérieure à C.

If bulbs are included with the luminaire, their energy classes are indicated at the bottom of the label.

Falls Leuchtmittel inkludiert sind, wird deren Energieklasse im unteren Teil des Labels angegeben.

Si des moyens d'éclairage sont inclus, leur classe énergétique est indiquée dans la partie inférieure du label.

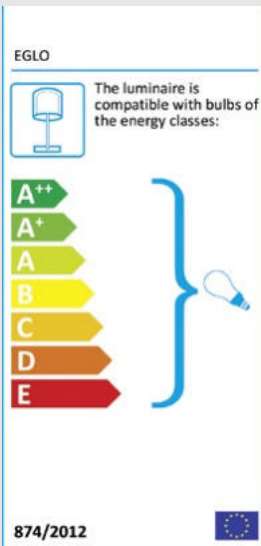

This label indicates that no bulbs are included with the luminaire. Consumers are free to choose their preferred bulb within the indicated energy classes.

Dieses Label wird verwendet, wenn die Leuchte ohne Leuchtmittel ausgeliefert wird. Der Kunde kann selber entscheiden, welches Leuchtmittel der angegebenen Klassen verwendet wird.

Ce label est utilisé lorsque la lampe est livrée sans ampoules. Le client peut décider lui-même quel ampoule des classes indiquées est utilisé.

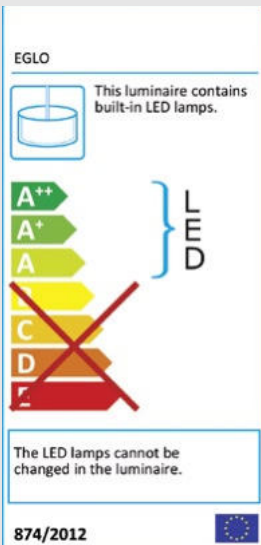

This label indicates that the luminaire is sold with built-in LED lamps that cannot be replaced by the consumer himself.

Dieses Label wird verwendet, wenn Leuchten mit LED-Modulen verkauft werden, die vom Endkunden nicht selbstständig ausgetauscht werden können.

Ce label est utilisé lorsque des lampes sont vendues avec des modules LED ne pouvant pas être changés par les clients finaux eux-mêmes.

EEI BUTTONS

bulbs included

inkl. Leuchtmittel | ampoules comprises



incl. highly efficient LED boards (cannot be replaced by the end consumer)

inkl. hocheffizienter LED Platinen (können nicht vom Endkonsumenten ausgetauscht werden)

incl. platines LED très efficaces (ne peuvent pas être remplacés par le consommateur final)



incl. highly efficient LED bulbs

inkl. hocheffizienter LED Leuchtmittel
ampoules à LED plus efficaces comprises



incl. efficient LED and/or fluorescent bulbs

inkl. effizienter LED und/oder Leuchtstoff-Leuchtmittel

ampoules à LED et/ou fluorescentes efficaces comprises



incl. halogen bulbs

inkl. Halogen-Leuchtmittel

ampoules halogènes comprises



GLASS ASSORTMENT

GLAS SORTIMENT

SORTIMENT DE VERRES

SPECIAL GLASS -

on this page we would like to give you a detailed view on an assortment of glasses that are used with our luminaires.

SPEZIAL GLAS -

Auf diesen Seiten möchten wir Ihnen einen detaillierten Blick auf ausgesuchte Gläser geben, welche wir für unsere Produkte verwenden.



VERRES SPECIAL -

Sur cette page nous voulons vous donner un aperçu détaillé des verres choisis que nous utilisons pour notre produits.

GLASS MATERIALS

GLAS-MATERIALIEN
MATÉRIAUX DE VERRE



glass alabaster, white
Glas alabaster, weiß
verre albâtre, blanc



glass alabaster, champagne
Glas alabaster, champagner
verre albâtre, champagne



coating, black
Beschichtung, schwarz
revêtement, noir



glass wipe technique, champagner
Glas Wischtechnik, champagner
verre technique à l'essuyés, champagner



limed glass
Glas gekalkt
verre chaulé



crystal
Kristall
cristal

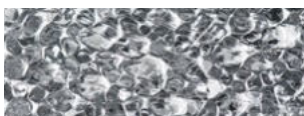

structured glass
Glas mit Struktur
verre structuré blanc



molten splinters of glass/crystal (granille)
geschmolzene Splitter von Glas / Kristall
(granille)
éclats fondus de verre / cristal (granille)



structured glass, white printed decor
strukturiertes Glas, weiß gedrucktes Dekor
verre structuré, décor imprimé blanc



printed glass with decor
bedrucktes Glas mit Dekor
verre imprimé avec la décoration



glass painted, green
Glas lackiert, grün
verre laqué, vert



glass red-orange
Glas rot-orange
verre rouge-orange



smoked glass, black-transparent
Rauchglas, schwarz-transparent
verre fumé, noir transparent



glass vaporized, black-transparent
Glas bedampft, schwarz-transparent
verre vaporisé, noir transparent



glass vaporized, amber
Glas bedampft, amber
verre vaporisé, ambre

EGLO WORLDWIDE

EGLO WELTWEIT

EGLO DANS LE MONDE



HEADQUARTERS
EGLO LEUCHTEN GMBH
Heiligkreuz 22
A-6136 PILL
T: +43 5242 6996 0 | F: +43 5242 6996 972
E: info-austria@eglo.com



CHILE - SANTIAGO
EGLO CHILE ILUMINACION LTDA.
Av. Américo Vespucio 1930
Conchalí - SANTIAGO DE CHILE
T: +562 2 595 2222
E: info-chile@eglo.com



DENMARK
EGLO DANMARK A/S
Agerbakken 20
DK-8362 Hørring
T: +45 70 22 55 11 | F: +45 70 22 55 21
E: info-denmark@eglo.com



AUSTRALIA
EGLO LIGHTING AUSTRALIA
5/339 Archerfield Road
Richlands | Queensland 4077
T: +61 7 3375 1413 | F: +61 7 3375 1412
E: info-australia@eglo.com



CHINA
DONGGUAN EGLO CHINA LIGHTING CO., LTD.
No.1 | Shangqiao Industrial Road | Shangqiao,
Dongcheng District
DONGGUAN CITY, GUANZHOU PROVINCE | CHINA
T: +86 769 2203 3866 | F: +86 769 2203 6866
E: info-china@eglo.com



ESTONIA
MOODNE VALGUSTUS AS
Rävala pst. 7
EE-10143 TALLINN
T: +372 667 6670 | F: +372 631 3195
E: info-global@eglo.com



BELGIUM
EGLO BELGIUM B.V.B.A.
Antwerpssesteenweg 247 | B-2950 Kapellen
Visit Address: Innovatiepark 20 |
4906 AA OOSTERHOUT (NL)
T: +32 3 250 60 80 | F: +32 3 219 80 67
E: info-belgium@eglo.com



COLOMBIA
EGLO COLOMBIA ILUMINACION SAS
AUTOPISTA NORTE KM 19 COSTADO LOTE 30
BOGOTÁ - CHIA
T: +57 (1) 744 2339
E: info-global@eglo.com



FINLAND
EGLO FINLAND OY
Malminraitti 17A
00700 Helsinki
T: +358 20 7649 820 | F: +358 20 7649 821
E: info-finland@eglo.com



BOSNIA-HERZEGOVINA
EGLO RASVJETA BH D.O.O.
Ormanica bb
BIH-76250 GRADACAC
T: +387 35 86 85 00 | F: +387 35 82 44 41
E: Info-Bosnia-Herzegovina@eglo.com



COSTA RICA
EGLO Costa Rica, Centro Comercial Calle Real local #8
Guachipilín de Escazú de la sucursal del BAC
San Jose 800 metros al norte San Jose Costa Rica.
T: +506-2289-4690, +506-2100-6384
E: Info-CostaRica@eglo.com



FRANCE
EGLO FRANCE LUMINAIRE SARL
Z.A. Jeune Bois | 2 Rue de la Martinique
F-68274 WITTENHEIM
T: +33 389 6250 30 | F: +33 389 6250 49
E: info-france@eglo.com



BULGARIA
EGLO BULGARIA EOOD
Main Road Burgas-Sofia, 5th kilometer,
Building KACHIKA, 8000 BOURGAS, Bulgaria
T: +359 56 960 403 | F: +359 56 53 05 95
E: info-bulgaria@eglo.com



CROATIA
EGLO RASVJETA D.O.O.
Jadranska avenija 9
HR-10020 Zagreb
T: +385 1 379 40 62 | F: +385 1 379 41 04
E: info-croatia@eglo.com



GERMANY
EGLO LEUCHTEN HANDELS GMBH
Kleinbahnstr. 35
D-59759 ARNSBERG
T: +49 2932 6269 0 | F: +49 2932 6269 39
E: info-germany@eglo.com



CANADA
EGLO CANADA INC.
20700 Route Transcanadienne
Baie-D'Urfé, Québec | H9X 4B7
T: +1 514 457 5483 | F: +1 514 457 5487
E: info-canada@eglo.com



CZECH REPUBLIC
EGLO CZ+SK s.r.o.
Náchodská 2479/63
CZ-193 00 PRAHA 9 Horní Počernice
T: +420 281 924 163 | F: +420 281 925 205
E: info-czechrepublic@eglo.com



GREECE
EGLO HELLAS A.E.
Sykias 2 and parodos dekeleias
ACHARNAI, GR-13679
T: +30 210 240 77 10 | F: +30 210 240 07 29
E: info-greece@eglo.com



GREAT BRITAIN
EGLO UK LTD.
 Unit 12 Cirrus Park, Lower Farm Road, Moulton Park
 Industrial Estate, NORTHAMPTON NN3 6UR
 T: +44 1604 790 986 | F: +44 1604 670 282
 E: info-greatbritain@eglo.com



MOROCCO
EGLO AFRICA
 219 Bd Med Zerkoutni. Suite: 67
 20330 CASABLANCA | Morocco
 T: +212 522 98 80 25 / 05
 E: info-global@eglo.com / info.africa@eglo.com



SPAIN
EGLO ESPANA ILUMINACION S.L.
 Avda. de Castilla 1 (Edf. Best Point) 2º-16A
 San Fernando de Henares, E-28830 MADRID
 T: +34 91 677 9044 | F: +34 91 677 0304
 E: info-spain@eglo.com



HUNGARY - PRODUCTION & LOGISTICS
EGLO MAGYARORSZAG KFT.
 Fő út. 155
 H-3060 PASZTO
 T: + 36 32 560 050 | F: +36 32 560 040
 E: info-hungary@eglo.com



THE NETHERLANDS
EGLO VERLICHTING NEDERLAND B.V.
 Innovatiepark 20
 4906 AA OOSTERHOUT (NBR)
 T: +31 162 48 28 30
 E: info-nl@eglo.com



SWEDEN
EGLO SVERIGE AB
 Star Street 1
 SE-512 50 SVENLJUNGA
 T: +46 340 623 505 | F: +46 340 623 605
 E: info-sweden@eglo.com



INDIA
EGLO INDIA PRIVATE LIMITED
 A-307 Ansal Chamber-1, 3 Bhikaji Cama Place,
 New Delhi-110066
 T: +91 981 108 2205 | T: +91 999 961 0450
 E: info-india@eglo.com



NORWAY
MS Belysning AS
 Heiaveien 4
 NO-1900 FETSUND
 T: +47 63 888500 | F: +47 63 888501
 E: info-norway@eglo.com



SWITZERLAND
EGLO SCHWEIZ AG
 Seetalstraße 142
 CH-6032 EMMEN
 T: +41 41 268 69 59 | F: +41 41 268 69 58
 E: info-switzerland@eglo.com



ITALY
EGLO ITALIANA S.R.L.
 Via Giotto, 4
 I-31021 MOGLIANO VENETO (TV)
 T: +39 041 45 66 232/245/251 | F: +39 041 45 74 066/071
 E: info-italy@eglo.com



PERU
EGLO PERU S.A.C
 Avda. Santa Cruz No. 458 Distrito de San Isidro
 Provincia y Departamento Lima, San Isidro - Lima
 T: +51 1 4212 158
 E: info-peru@eglo.com



TURKEY
Eglo Aydınlatma İthalat İhracat Ltd. Şti.
 Eyüp Sultan Mah. Sekmen Cad. No:18/2
 34855 SAMANDIRA, SANKANTEPE / İSTANBUL
 T: +90 216 311 09 -02 / -03 / -04 | F: +90 216 311 09 -05
 E: info-turkey@eglo.com



KAZAKHSTAN
EGLO KAZAKHSTAN LLP
 Office 72, 14th floor, Block 4A, Nurlı-Tau Business Centr,
 Al-Farabi Avenue 7, 050059 Almaty, Kazakhstan
 T: +7 727 293 25 20 | M: +7 701 031 00 00
 E: info-kazakhstan@eglo.com



POLAND
EGLO POLSKA SP. Z.O.O.
 Ul. Pulawska 479
 02-844 WARSZAWA
 T: +48 22 644 57 55 | F: +48 22 644 89 82
 E: info-poland@eglo.com



USA
EGLO USA, INC.
 3640 Royal South Parkway
 ATLANTA, GEORGIA 30349
 T: +1 404 477 5601 | F: +1 404 393 7053
 E: info-usa@eglo.com



KOSOVO
EGLO KOSOVA LLC
 Luginisht e qytetit pn
 20000 PRIZREN- KOSOVO
 T: +377 44 2166 87 | Shop: +381 29 2442 84
 E: info-kosovo@eglo.com



PORTUGAL
EGLO PORTUGAL ILUMINAÇÃO, LDA
 Rua Fonte Parada, 125
 PT-4595-434 SEROA-PAÇOS DE FERREIRA
 T: +351 255 890 000 | F: +351 255 892 346
 E: info-portugal@eglo.com



UKRAINE
EGLO UKRAINE LTD
 bulv. Vatslav Havel 6/7A
 UA-03680 KIEV
 T: +38 044 463 98 41 | F: +38 044 468 84 67
 E: info-ukraine@eglo.com



LITHUANIA
MOODNE VALGUSTUS AS
 Rāvala pst. 7
 EE-10143 TALLINN
 T: +370 652 49923 | T: +372 667 6670
 E: info-lithuania@eglo.com



ROMANIA
EGLO ROMANIA PRODEXIM SRL.
 Str. Atomistilor nr. 1D
 R-077125 MAGURELE - ILFOV - ROMANIA
 T: +40 314 250 902 | F: +40 314 250 899
 E: info-romania@eglo.com



MAGYARORSZÁG – ÉRTÉKESÍTÉS
EGLO LUX KFT.
 Fő út. 143/A
 H-2120 DUNAKESZI
 T: +36 27 341 353 | F: +36 27 341 409
 E: info-hungary@eglo.com



RUSSIA
EGLO LIGHTING LLC
 Varshavskoe shosse 35 | Building 1
 RU-117105 | MOSCOW
 T: +7495 789 4311 | F: +7495 789 4312
 E: info-russia@eglo.com



MALAYSIA
EGLO ASIA SDN BHD
 No. 13, Jalan Pelukis U1/46B, Temasya 18, Glenmarie,
 40150 Shah Alam, Selangor Darul Ehsan, Malaysia
 T: +6011 1050 2336 | F: +603 5567 9415
 E: info-malaysia@eglo.com



SERBIA
EGLO RASVETA DOO
 Stefana Prvovenčanog 28
 11000 BEOGRAD | SRBIJA
 T: +381 11 3981 366 | F: +381 11 3981 389
 E: info-serbia@eglo.com



MEXICO
EGLO MÉXICO ILUMINACIÓN S DE RL DE CV
 Prolongación Avenida López Mateos Sur N°3561,
 Fraccionamiento Los Gavilanes.
 C.P. 45645, Tlajomulco de Zúñiga, Jalisco, México
 T: +52 33 3687 20 95 | E: info-mexico@eglo.com



SLOVAKIA
EGLO CZ+SK s.r.o
 Náchodská 2479/63
 CZ-193 00 PRAHA 9 Horní Počernice
 T: +421 313 211 551 | F: +421 313 211 556
 E: info-slovakia@eglo.com



MIDDLE EAST
EGLO LIGHTING MIDDLE EAST FZE
 P.O. BOX 262073, LOB 6, OFFICE G18
 JEBEL ALI, DUBAI, UAE
 T: +97 148810080 | F: +97 148810081
 E: info.me@eglo.com



SLOVENIA
EGLO RASVJETA D.O.O.
 Jadranska avenija 9
 HR-10020 Zagreb
 T: +386 158 093 18
 E: info-slovenia@eglo.com

HOW TO READ

ERKLÄRUNG

COMMENT LIRE

DIMENSIONS DIMENSIONEN DIMENSIONS

all dimensions in mm | alle Größen in mm | toutes dimensions en mm

L = length | Länge | longueur

B = width | Breite | largeur

H = height | Höhe | hauteur

∅ = diameter | Durchmesser | diamètre

A = projection length | Ausladung | amplitude

ET = installation depth | Einbautiefe | profondeur utile

Base = base dimensions | Sockelmaße | dimensions de base

Attention! The dimensions relate solely to the sizes of the luminaire.
Any air spaces that would be relevant for a safe operating of the lamp were not considered.

Achtung! Die Größen beziehen sich nur auf die Abmessungen der Leuchte. Etwaige Lufträume, die für einen sicheren Betrieb der Leuchte notwendig sind, werden nicht berücksichtigt.

Attention! Les dimensions se réfèrent à la taille de la lampe seulement. Espacements éventuels, que seraient importants pour une opération de la lampe sans danger, n'ont pas été considérés.

BUTTONS BUTTONS BOUTONS

Colour Rendering Index | Farbwiedergabeindex | Indice de rendu de couleur de LED

CRI
>90

p.557

Bulb included | Leuchtmittel inkludiert | ampoules inclus



Recessed Luminaire | Einbauleuchte | luminaire encastrable



Surface Luminaire | Aufbauleuchte | luminaire en saillie



99445 ALBARIZA
pendant light; steel, wood, black, brown / fabric, cappuccino, gold
Hängeleuchte; Stahl, Holz, schwarz, braun / Textil, cappuccino, gold
luminaire en suspension; acier, bois, noir, marron / tissu, cappuccino, or
H 1100, ∅ 160

9 002759 994457

99446 ALBARIZA
pendant light; steel, wood, black, brown / fabric, cappuccino, gold
Hängeleuchte; Stahl, Holz, schwarz, braun / Textil, cappuccino, gold
luminaire en suspension; acier, bois, noir, marron / tissu, cappuccino, or
L 895, H 160, H 1100

9 002759 994464

99447 ALBARIZA
pendant light; steel, wood, black, brown / fabric, cappuccino, gold
Hängeleuchte; Stahl, Holz, schwarz, braun / Textil, cappuccino, gold
luminaire en suspension; acier, bois, noir, marron / tissu, cappuccino, or
H 1500, ∅ 700

9 002759 994471

LIGHTING FAMILIES / FABRIC
164

ARTICLE NUMBER
ARTIKELNUMMER
NUMÉRO D'ARTICLE

SERIES NAME
SERIENNAME
NOM DE LA SÉRIE

DESCRIPTION
BESCHREIBUNG
DESCRIPTION

The product description is composed as follows:
luminaire type; enclosure material, enclosure colour / glass or shade material, glass or shade colour

Die Produktbeschreibung setzt sich wie folgt zusammen:
Leuchtenart; Gehäusematerial, Gehäusefarbe / Schirm- bzw. Glasmaterial, Schirm- bzw. Glasfarbe

La description du produit est composée comme suit:
type de luminaire; matériel de boîtier, couleur de boîtier / matériel de verre ou abat-jour, couleur de verre ou abat-jour

SPARE PARTS
ERSATZTEILE
PARTS DE REMPLACEMENT

If spare parts for product are available they are marked on the photograph with their corresponding article number.

Wenn zu einem Produkt Ersatzteile vorhanden sind, werden diese in der Abbildung mit der entsprechenden Artikelnummer markiert.

Si un produit a des parts de remplacement, elles sont marquées avec le numéro d'article dans la photo.



PRODUCT / PRODUCT IN THE AMBIANCE
PRODUKT / PRODUKTE IM AMBIENTE
PRODUITS / PRODUITS DANS L'AMBIENCE

You can find the article number next to each product on the page and in the ambiance pictures.
Sie finden die Artikelnummer jedes Produktes neben der Abbildung auf der Seite und auf unseren Ambientebildern.
Vous pouvez trouver le numéro d'article à la page et à côté de chaque produit dans les images de l'ambiance.

BUTTONS
BUTTONS
BOUTONS

Forest Stewardship Council®



p.8-9

PICTOGRAMMES
PIKTOGRAMME
PICTOGRAMMES

Technical details are represented as pictograms. An overview over all pictograms can be found on the next pages.

Technische Details werden als Piktogramme dargestellt. Eine Übersicht über alle Piktogramme finden Sie auf den nächsten Seiten.

Les détails techniques sont représentés sous forme de pictogrammes. Vous trouverez un aperçu de tous les pictogrammes dans les pages suivantes.

SKETCHES
SKIZZEN
CROQUIS

The sketches state the most meaningful dimensions. If a product is adjustable by will, a turquoise arrow marks this function and only the maximum dimensions are indicated.

Die Bemaßung der Skizzen umfasst jeweils die aussagekräftigsten Größen. Bei verstellbaren Produkten kennzeichnet ein türkiser Pfeil diese Funktion und nur die maximalen Größen werden angegeben.



















Les dimensions des croquis comprennent les plus représentatives. Si un produit est réglable au choix, une flèche turquoise affiche cette fonction et rien que les dimensions maximales sont indiquées.

LIGHTING FAMILIES / FABRIC
165



















































PICTOGRAM

PIKTOGRAMME PICTOGRAMME

SOCKETS / FASSUNGEN / DOUILLES

 LED	 G4	 G53
 2G7	 G5	 GU5,3 / MR16
 2G11	 G9	 GU10
 2GX13	 G10Q	 GX53
 E14	 G13	 GY6,35
 E27	 G23	 R7s

BULBS / LEUCHTMITTEL / AMPOULES

 E14 / C35	 E27 / A60 Halogen	 E27 / E140 Filament
 E14 / C35f	 E27 / R63 Halogen	 E27 / PS160 Filament
 E14 / D45	 E27 / A60 LED	 E27 / T30 Filament
 E14 / C35f LED	 E27 / A60 Filament	 E27 / T32 Filament
 E14 / D45 Halogen	 E27 / A65 LED	 G4 / T9
 E14 / C35 Halogen	 E27 / A75 Filament	 G4 / LT9
 E14 / T22	 E27 / G45 LED	 G4 / LT14
 E14 / C35 Filament	 E27 / G45 Filament	 G9
 E14 / C37 Filament	 E27 / G80 Filament	 G9 LED
 E14 / C35f Filament	 E27 / G95	 GU10
 E14 / C37f Filament	 E27 / G95 Filament	 GU10 LED
 E14 / P45 LED	 E27 / G125	 GU10 SMD LED
 E14 / P45 Filament	 E27 / G95 LED	 GX53 / LF75
 E14 / P50	 E27 / G200 Filament	LED LED board / LED Platine / LED bord
 E14 / ST48 Filament	 E27 / R63 LED	 MR16
 E14 / ST64 Filament	 E27 / ST48 Filament	 MR16 LED
 E14 / T20 LED	 E27 / ST64 Filament	 R7s / 78mm
 E27 / A60	 E27 / B80 Filament	 R7s / 118mm
 E27 / G90	 E27 / BR150 Filament	 R7s / 78mm LED
 E27 / QR63	 E27 / DP165 Filament	 R7s / 118mm LED

LIGHT COLOUR & LUMEN / LICHTFARBE & LUMEN / COULEUR LUMINEUX & LUMEN

The colours of the LED are represented as pictogrammes (see below), their luminous flux directly beneath. The luminous flux is quoted in lumen and describes the amount of light generated by the LED. The higher the value, the brighter is the lamp. Lumens are LED boards and are the light measurement value in bulbs.

Die Farben der LED werden als Piktogramm (siehe unten) dargestellt, deren Lichtstrom direkt darunter. Der Lichtstrom wird in Lumen gemessen und gibt die erzeugte Lichtmenge der LED an. Je höher der Wert, desto heller das Produkt. Lichtstromangaben (Lumen) sind Platinen- bzw. Leuchtmittelwerte.

Les couleurs de LED ont représentés sous forme de pictogrammes, leur flux lumineux directement en dessous. L'unité de flux lumineux est le lumen et il mesure la quantité de lumière générée par les LED. Plus la valeur est élevée, plus la lampe est lumineuse. Les lumens sont l'unité de mesure de l'intensité lumineuse des ampoules et des panneaux led intégrés.

	RGB RGB RGB		RGB + neutralwhite RGB + neutralweiß RGB + blanc neutral		cold white kaltweiß blanc froid
	RGB + white RGB + weiß RGB + blanc		RGB + tunabel white RGB + tunabel white RGB + tunabel white		neutral white neutralweiß blanc neutre
	RGB + warmwhite RGB + warmweiß RGB + blanc chaud		tunable white tunable white tunable white		
	RGB + coldwhite RGB + kaltweiß RGB + blanc froid		warm white warmweiß blanc chaud		

SWITCHES & SENSORES / SCHALTER & SENSOREN / INTERRUPTEUR & CAPTEURS

	incl. cable & plug inkl. Kabel & Stecker câble & connecteur inclus		pedal switch Trittschalter interrupteur à pied		swedish plug Stecker Schweden connecteur swede
	internal dimmer eingebauter Dimmer variateur intégré		cable switch Kabelschalter interrupteur à câble		"Touch me" ON/OFF "Touch me" EIN/AUS "Touch me" ON/OFF
	button switch Druckknopf interrupteur de pression		incl. cable & plug transformer inkl. Kabel & Stecktransformator câble & transformateur à prise		"Touch me" ON/OFF & dimm "Touch me" EIN/AUS & Dimmen "Touch me" ON/OFF & graduable
	function switch Funktionsschalter interrupteur fonction		remote control Fernbedienung télécommande		pull switch Zugschalter interrupteur à bascule
	rocker switch Wippschalter interrupteur à bascule		Day & Night Sensor Tag & Nacht Sensor sensor jour & nuit		Timer - automatic on/off Zeitschaltuhr - automatisches Ein- & Ausschalten minuterie - peut être éteint et allumé automatiquement
	pedal dimmer Trittdimmer variateur à pied		sensor Sensor sensor		

FUNKTIONS & COMFORT / FUNKTIONEN & KOMFORT / FONCTIONS & CONFORT

	incl. battery inkl. Akku incl. pile		cutout (in mm) Ausschnitt (in mm) perçage du panneau (en mm)		packaging / delivery unit Verpackungs- / Liefereinheit unité d'emballage / de livraison
	incl. battery inkl. Batterie incl. pile		dimmable with external dimmer dimmar mit externen Dimmer gradable avec un gradateur externe		shortable kürzbar réductible
	battery specifications Batteriespezifikationen spécifications des piles		not dimmable nicht dimmbar ne pas graduable		Voltage Volt Voltage
	beam angle Ausstrahlwinkel angle de rayonnement		Can be operated via control unit Bedienbar über Steuergerät Peut être commandé par une unité de contrôle		Watt
	corner mount possible Eckmontage möglich montage en coin possible		replaceable LED austauschbare LED LED remplaçables		USB connection USB-Anschluss Connexion USB
	Colour Rendering Index		loadable in kg belastbar in kg chargeable en kg		Qi-Charger

PROTECTION CLASS / SCHUTZKLASSE / CLASSE DE PROTECTION

The protection class indicates to what extent the lamp is protected against electric shock. All lamps in this catalogue are at least protected with the protection class 1 - a higher class is specified in the information box of the respective lamp.

Die Schutzklasse gibt an, inwiefern ein Produkt gegen einen elektrischen Schlag gesichert ist. Alle Leuchten in diesem Katalog sind mit mindestens Schutzklasse 1 gesichert, bei höheren Klassen wird das Symbol im Infokasten der Leuchte angegeben.

La classe de protection indique, dans quelle mesure la lampe est protégée contre les chocs électriques. Tous les lampes dans ce catalogue sont protégés au moins avec la classe 1 - une classe plus élevée est indiquée dans l'information de la lampe.

	protection class 1: protective earthing Schutzklasse 1: Schutzerdung classe de protection 1: prise de terre		protection class 2: protective insulation Schutzklasse 2: Schutzisolierung classe de protection 2: double isolation ou renforcée		protection class 3: protective low voltage Schutzklasse 3: Schutzkleinspannung classe de protection 3: très basse tension de sécurité
--	---	--	--	--	---

PROTECTION RATING / SCHUTZGRAD / INDICE DE PROTECTION

The protection rating ensures the operational safety of luminaires. The first number specifies the extent of the protection against the ingress of foreign bodies; the second number identifies the humidity protection grade. All luminaires in this catalogue are at least protected with the rating IP20 - a higher rating is specified in the information box of the luminaire.

Der Schutzgrad gewährleistet die Betriebssicherheit von Leuchten. Die erste Ziffer des IP Grades beschreibt den Schutzzumfang gegen das Eindringen von Fremdkörpern, die zweite Ziffer informiert über den Grad des Feuchtigkeitsschutzes. Alle Leuchten in diesem Katalog sind mit mindestens Schutzgrad IP20 gesichert, bei höheren Graden wird das Symbol im Infokasten der Leuchte angegeben.

L'indice de protection assure la sécurité opérationnelle des luminaires. Le premier chiffre indique à quel point la protection est efficace contre l'insertion de corps étrangers; le second chiffre indique quant à lui le degré de protection par rapport à l'humidité. Tous les luminaires dans ce catalogue sont protégés au moins avec l'indice IP20 - un indice plus élevé est indiqué dans l'information d'article.

	IP33		IP44		IP54		IP65		IP67
--	------	--	------	--	------	--	------	--	------

REGISTER

SERIES NAMES
SERIENNAMEN
NOME DE PRODUITS

NAME NAME NOM	PAGE SEITE PAGE	NAME NAME NOM	PAGE SEITE PAGE	NAME NAME NOM	PAGE SEITE PAGE
ABREOSA	212	BANKER	774	BOLSANO	338-339
ACCESS REMOTE	82	BARBOTTO	722	BONARES 1	230-231
ACOLLA	458	BARI 1	605	BORGILLO	723, 772-773
ACOLLA 1	458	BARI-M	570	BOYAL	202-205
ALAMEDILLA	278	BARNHAM	664-665	BRENDA	401-402, 404
ALBANY	407	BASIC	776-777	BUDENSEA	721
ALBARACCIN	330-331	BASIC 1	776	BUENAVISTA	612
ALBARIZA	164	BASILANO	308-309	BUENAVISTA 1	614
ALEANDRO 1	338	BASILANO 1	306-307	BUENAVISTA 2	614-615
ALESSANDRA	407	BASURTU	443	BUTRANO	369
ALMEIDA	169	BATALLAS	628-629	BUZZ-LED	692-693
ALMEIDA 1	168	BATISTA 3	261	CABADO	707
ALMEIDA 2	166-167	BAYA	729	CABADO 1	768
ALMERA	521	BAYA LED	726-727	CABALES	766-767
ALMONTE	562	BAYMAN	259	CABO	448
ALOBRASE	319-321	BELATEGI	533	CABO 1	698
ALTAFLOR	418-420	BELESER	232-233	CABUS	582
ALVEZ	409	BELLARIVA	736-737	CADAQUES	322
AMADORA	260	BELLARIVA 3	736	CADAQUES 1	322
AMEZAGA	742	BELSIANA	434	CADEGAL	546-547
AMEZOLA	558	BELSIANA 1	435	CAHUAMA	738-739
AMONTILLADO	364, 424	BENARIBA	486	CAILIN	602
ARENAZA	755	BERREGAS	636	CAJERO	768-769
ARISCANI	324-325	BIMEDA	668-671	CALMANERA	380-381
AZBARREN	206	BITACHITO	358	CALNOVA	590
BALIOLA	791	BOCADELLA	354	CAMACHO	200-201
BANDERALO	756	BOCADELLA 1	432	CAMARGO	362
BANDERILLAS	278-279	BOGOTENILLO	366	CAMASTRA	387

NAME NAME NOM	PAGE SEITE PAGE	NAME NAME NOM	PAGE SEITE PAGE	NAME NAME NOM	PAGE SEITE PAGE
CAMBULOS	364	COGOLETO	489	DURENGO	764
CAMINALES-Z	26	COLTI	522	EGIDONELLA	276-277
CAMPANIA	522	COMPETA 1	488-490	ELGVERO	545
CAMPILO	392	COMPETA 2	488	ELIZONDO	542
CANICOSA 2	462	CONCESSA 1	162-163	ELLA	502
CANTALLOPS	387	CONDRADA 1	446	ENALURI	346
CANTERRAS	210-211	CONESA	718	ENCINITOS	379, 435
CAPASSO	492	CONESSA	344-345	ENEA	662-663
CAPASSO 1	487	CONNECT Z	21	ERMUA	365, 743
CAPASSO-Z	35	CONNECT-Z SENSOR	21	ERSEKA	226-227
CARBONERAS	721	CONSACA	638	ERVIDEL	268-269
CARDILLIO 1	700-701	CORBERA	684	ESCANDIDOS	222-223
CARDITO	459	CORETTO	335	ESPARTAL	719
CARDITO 1	340	CORREDERA	366	ESTAZIONA	717
CARLTON 2	733	CORTADERAS	218-219	ESTEPERRA	136, 139, 631
CAROVIGNO	644	CORTENOVA	350-351	ESTEVAU	371
CARPENTO	310	COSSANO	184, 186-187	EXTENTION	793
CARTAMA	347	COSSANO 2	188	FABIO	779
CARTIGNANO	528	COSWARTH	642	FALICETTO	542
CASIBARE	214-215, 640	CREMELLA	216-217	FARSALA	327
CASTELLATO	743	CURASAO	378	FEDRA 2	341
CASTRALVO	396	DAKAR 1	660-661	FELONICHE	535
CAUPO	758	DAKAR 3	706	FIRMO	775
CEPPINO	762	DAMASCO 1	745-746	FLORESTA	376
CERASELLA	333	DAMBERA	764	FONDACHELLI	716
CERCAMAR	741	DARNIUS	722	FOX	778-779
CHIETINO 1	734	DAVIDA	676-677	FOX 1	778
CIGLIE	527	DAVIDA 1	678-679	FRADELO	454-456
CIVITATE	529	DESIERTO	749	FRADELO 1	452-453
CLEMENTE	228-229	DIAMOND	341	FRAIOLI-Z	30-31
CODRIALES	367	DUNDRY	788-789	FRANIA	472-473, 476-477, 570-571
COGNOLI	758-759	DURELO	503	FRANIA-A	86-87

NAME NAME NOM	PAGE SEITE PAGE	NAME NAME NOM	PAGE SEITE PAGE	NAME NAME NOM	PAGE SEITE PAGE
FRANIA-S	474-475, 478-479	LABARETU	431	LOSALOMAS	382
FUERTECUSA	459	LAGUNITAS	332	LUBERIO	342
FUEVA 5	576, 578, 606-611	LANCIANO	484-485	MACCACARI	534
FUEVA-A	92	LANCIANO 1	484	MAGITTA 1	514
FUEVA-Z	48-59	LANCIANO-Z	34	MAGNUM LED	695
GAETANO 1	398, 400, 402-403	LAPELA	295	MAGNUM-LED	694-695
GALDAKAO	526	LAROA	760-761	MALVA	520
GASCUERIA	542	LASANA	286, 552	MAMBLAS	741
GATUELA	360-361	LASANA 1	285-287	MANALBA	735
GATUELA 1	360	LASANA 2	284-285, 287	MANALBA 1	735
GEO	747	LASANA 3	282-283	MANILVA 1	571
GERBERA 1	522	LAURITO	496	MANIZALES	357
GEXO	766	LAZOLO	404	MANTUNALLE	238-239
GIRON	470	LEBALIO	318	MANTUNALLE 1	236-237
GIRON-S	471	LED CARPI	574-575	MARSALES	142, 144
GITA 2	588	LED LORA	573	MARBELLA	266-267
GOROSIBA	234-235	LED PALERMO	573	MARGHERA-Z	24-25
GOROSIBA 1	234	LED PLANET	504	MARGITTA 1	510-511
GRADOLI	356	LED STRIPE-Z	64-65	MARINELLO	425
GRADOLI 1	357	LED-STRIPE-A	94	MARINELLO 1	424
GRAFIK	516	LEGANES	501	MAROJALES	445
GRIMALDINO		LEJIAS	280-281	MARONDA	170
GROMOLA	422	LIBERTAD	198-199	MARS	512-513, 518
GURARE	530	LIDSING	734	MARS 1	512-514
HERRORA-Z	40	LM_LED_E14	66, 96	MASERLO	146-147, 152-154, 156-161
IMPERIAL	520	LM_LED_E27	66, 68-77, 96-98	MASERLO 1	149-150
IPLITTO	422	LM_LED_GU10	67, 98-99	MASERLO 2	146, 154, 157, 160
ISIDRO	270-271	LOBATIA	359	MASETA	374-375
JUAREZA-Z	29	LOCANDA	672	MASIANO 1	450-451
JUNIOR 1	784	LOMALTAS-Z	28	MASSERIE	754
KOB LED	791	LONCINO 1	337	MATARO	738
LA SECA	757	LORD 2	406	MATARO 1	738

NAME NAME NOM	PAGE SEITE PAGE	NAME NAME NOM	PAGE SEITE PAGE	NAME NAME NOM	PAGE SEITE PAGE
MENDIETA	430	NERINI	461	PAUSIA	290
MENTALURGIA	500	NEVADO	293	PAWEDO 1	698
MESTRE	520-521	NIEVES	492-493	PEDREGAL 1	732
METRASS	548	NOCITO	666-667	PEDRISTELLA	551
METRASS 1	550-551	NOSINO	717	PENJAMO	499
METRASS 2	549	NOVAFELTRIA	300-301	PERPIGO	363
MEZZANA	354	NUVANO	398-399	PERTINI	294
MINI 4	708	OBREGON	393	PESCAITO	494
MIOGLIA 1	344	OILELLA	316-317	PETTO 1	741
MIRLAS	426	OKINZURI	371	PHIANEROS	274
MIRTAZZA	370	OLIVAL 1	743	PICACHA	720
MOGANO	440	ONO 2	533	PINTO	254-255
MOGANO 1	400	OPTICA	240, 242-243	PINTO GOLD	252-253
MONGODIO 1	544	PALBIETA	272-273	PINTO NERO	250
MONIROTE	419, 421	PALERMO 2	491	PINTO TEXTIL	248-249
MONO	604-605	PALMERA	602	PITALE	460
MONTEBALDO	358, 436	PALMITAL	566	PLANET	504
MONTEFINO	348	PALOMARO	464-466	PLANET 1	506-509
MONTEFIO	404	PALOMARO 1	464-466	POLLICA	634
MONTEFIO 1	342-343	PALOZZA	298-299	POSADERRA	112-114
MONTENOVO	463	PALOZZA 1	296	POZONDON	463
MORATICA - A	87	PANDELLA 1	596-599	POZUETA	353
MOSIANO	566	PANDELLA 2	596, 600	PRINCE 1	778
MULEGES	377	PASCAL 1	521	RAMON	386
MURCIA	262-263	PASSA	538-541	RAYA	514
MURMILLO	326	PASSA RELLA	430	RAZONI	372-373
MUSARA	431	PASSANO 1	436	REDUCTA 2	501
MUSURITA	494-495	PASTERI	108-111, 116-131, 731	REKALDE	720
NADINA	719	PASTERI SQUARE	112-114	REMIDOS	547
NARANJO	749	PASTORE	468	REMOTE 2.0	21
NARICES	220-221	PASTORE 1	468	RICCIO 1	706
NEMO	516	PASTORE 2	469	RICONTO 1	510

NAME NAME NOM	PAGE SEITE PAGE	NAME NAME NOM	PAGE SEITE PAGE	NAME NAME NOM	PAGE SEITE PAGE
RIVATO	258-259	SANTANDER	719	SPADAFORA	364, 424
ROCAMAR	334, 336	SARABIA	403	STAITI	436-437
ROCAMAR 1	335-336	SARGINTO	552-553	STAITI 1	524
ROCCAFORTE	388-391	SARRIA	680-683	STELLATO 1	176-177
ROLIMARE	422	SARRIONE	728	STELLATO 2	178-179
ROMAGNESE	338	SARSINA -A	88	STELLATO 3	180-181
ROMAO	106-107	SAVATARILA -Z	36-37	STICKER	603
ROMAO 1	106	SAVOY	264-265	SWARBY	740
ROMAO 3	107	SCALEA 1	512	TABARA	784
ROMENDO 1	580-581	SCIGLIATI	716	TABIAGO	224
RONCADE	289, 296	SEGEZIA	385	TABIANO	593
RONCADE 1	288	SELLANO	756	TABIANO-Z	29
RONDO	244-245	SELUCI	496-497	TABILLANO	648
ROTTELO	690-691	SELVINA	290-291	TABILLANO 1	524, 770
ROVIRA	361	SELVINA 1	288	TAMARA 1	560-561
ROVITO-Z	60-63	SELVINO	328-329	TAMURIA	428
RUEDA	794	SENDERO	190-191	TARANDELL	295
RUFFO	785	SERAS	656-657	TAREGA	208
RUIDERA	481	SERAS 1	654-655	TAZZOLI	530
SABINAR	394-395	SERAS 2	658-659	TERRIENTE	720
SALICETO-Z	27	SIDERNO	584	TEYA	790
SALITERAS -Z	37	SILENTINA	438-439	TINDARI	323
SALITRE	367	SILERAS	480-481	TINDORI	182-183
SALOBRENA -A	90-91	SILERAS -A	85	TINEO	710-711
SALOBRENA -Z	44-47	SILERAS -Z	35	TOLORICO	564
SALOME	518-519	SILVARES	209	TOMBOLO	170
SALTO	702-703	SIMOLARIS -Z	22-23	TORONA 1	770
SAMBATELLO	646-647	SLIM	745	TORONJA	501
SAN CARLO	784	SNAPORA	764	TORRETTA	591
SAN PERI	524	SOLO	745	TORRONTES	322
SANIA 4	536-537	SOLO 1	744	TOTARI -Z	32-33
SANIA 5	584-585	SORRENTA 1	461	TOWNSHEND 3	620-623

NAME NAME NOM	PAGE SEITE PAGE	NAME NAME NOM	PAGE SEITE PAGE
TRAGACETE 1	586-587	VOLTAGO 2	482-483
TREMEDAL	431	WASAO 1	568-569
TRONDIO	736	ZABALEA	330
TROY 3	256-257	ZAMUDILO	480
TRUNCA	754	ZAPATA	652-653
TUKON 3	688	ZAPATA 1	650
TURCONA-Z	38, 42-43	ZERACO	686
TURIALDO	196	ZINACUA	531
UP 2	724-725	ZOCABON	376
VADUMI	594	ZOLA	604
VALBIANO	632-633	ZUBIALDE	532
VALCASOTTO	442, 498	ZUBIETA-A	82-84
VALDELAGRANO-Z	22		
VALECROSIA	368		
VALLASPRA	246-247		
VALLEMARE	460		
VALMORA	292-293		
VARILLAS	140-141		
VARRAZO	341		
VERADAL	762-763		
VEREDA	511		
VERGIANO	674-675		
VERSUOLA	445		
VETRO	408-409		
VIGLIONI	397		
VIKI 1	785		
VILANOVA	696-697		
VILLABATE	624-627		
VILLABATE 1	730-731		
VINCHIO	600		
VINOVO	262		
VISERBELLA	132-134		



REGISTER

ARTICLE NUMBER
ARTIKELNUMMER
NUMÉROS D'ARTICLE

NUMBER NUMMER NUMÉRO	PAGE SEITE PAGE	NUMBER NUMMER NUMÉRO	PAGE SEITE PAGE	NUMBER NUMMER NUMÉRO	PAGE SEITE PAGE	NUMBER NUMMER NUMÉRO	PAGE SEITE PAGE	NUMBER NUMMER NUMÉRO	PAGE SEITE PAGE	NUMBER NUMMER NUMÉRO	PAGE SEITE PAGE
11801	99	12239	71	31001	668	31592	120	31995	289	33682	574
11802	98	12241	74	31002	669	31594	129	31996	289	33941	546
11804	96	12242	74	31003	668	31595	119	31997	296	33942	547
11805	96	12243	74	31004	668	31596	123	32001	698	33964	547
11806	96	12244	75	31005	670	31599	153	32025	459	33984	234
11807	97	12245	75	31006	671	31601	146	32026	459	33994	21
11809	98	12251	67	31007	671	31602	156	32048	286	39092	308
11811	98	12252	66	31008	671	31603	159	32765	650	39093	309
12221	72	12253	66	31254	504	31605	153	32766	650	39094	309
12222	72	12254	66	31571	127	31606	146	32767	650	39095	308
12223	72	12255	76	31572	116	31607	156	33168	621	39099	306
12224	73	12256	76	31573	121	31608	160	33169	620	39101	306
12225	73	12257	76	31574	125	31611	152	33171	620	39102	307
12226	68	12258	77	31575	126	31613	157	33172	620	39103	306
12227	68	3041	408	31576	117	31614	159	33199	82	39112	310
12228	68	30658	546	31577	121	31616	152	33344	390	39113	310
12229	69	30659	546	31578	125	31618	156	33345	388	39114	310
12231	69	30832	678	31579	126	31619	159	3355	407	39751	206
12232	69	30833	679	31581	116	31627	154	33645	627	39752	206
12233	70	30834	679	31582	120	31628	147	33646	626	39753	206
12234	70	30835	679	31583	124	31629	158	33647	626	39836	278
12235	70	30931	448	31585	116	31631	160	33648	626	39838	278
12236	71	30932	448	31586	120	31666	401	33677	561	39839	279
12237	71	30933	448	31588	127	31667	341	33678	561	43637	440

NUMBER NUMMER NUMÉRO	PAGE SEITE PAGE	NUMBER NUMMER NUMÉRO	PAGE SEITE PAGE	NUMBER NUMMER NUMÉRO	PAGE SEITE PAGE	NUMBER NUMMER NUMÉRO	PAGE SEITE PAGE	NUMBER NUMMER NUMÉRO	PAGE SEITE PAGE	NUMBER NUMMER NUMÉRO	PAGE SEITE PAGE
7184	518	83155	506	86712	520	89758	514	900058	42	900102	48
7186	518	83156	507	86715	521	89832	254	900059	42	900103	54
7188	519	83157	508	86811	242	89833	255	900061	43	900104	54
80263	513	83159	508	86812	242	89834	254	900062	43	900105	52
80264	513	83162	508	86813	240	89835	254	900067	24	900106	52
80265	518	83163	509	86814	240	89836	255	900068	24	900107	53
81262	779	83404	502	86815	240	900001	32	900069	24	900108	58
81265	779	83405	604	86816	242	900002	32	900071	25	900109	59
81635	502	83406	604	86817	243	900005	34	900072	25	900111	50
81636	502	84028	516	86955	778	900006	34	900075	22	900112	50
81827	747	85104	744	87008	406	900008	35	900076	31	900113	50
81828	747	85261	244	87009	406	900019	29	900077	31	900114	56
82305	745	85262	244	87054	404	900021	29	900078	31	900115	56
82741	520	85263	245	87055	401	900022	37	900079	30	900128	35
82747	265	85264	245	87219	602	900023	37	900081	30	900129	35
82748	264	85338	604	87222	602	900024	37	900082	30	90015	520
82749	264	85339	605	87254	744	900025	36	900083	34	90043	512
82751	265	85832	603	87256	744	900044	44	900084	32	90048	260
82752	265	85856	266	87284	784	900045	44	900085	33	90049	260
82785	408	85857	266	87793	521	900046	44	900086	60	90304	250
82786	408	85858	267	88472	660	900047	45	900087	61	90305	250
82842	724	85859	266	88473	661	900048	45	900088	60	90696	341
82843	724	85971	729	88474	660	900049	46	900089	60	90697	522
82844	725	85974	729	88475	660	900051	46	900091	63	90737	522
82942	504	85977	256	88968	793	900052	46	900092	62	90872	775
82944	504	85978	256	88969	793	900053	47	900093	62	90873	775
83119	516	85979	256	89115	521	900054	38	900094	62	90874	775
83132	516	85981	257	89238	513	900055	38	900095	47	90914	690
83153	507	85982	257	89239	512	900056	38	900099	48	90915	690
83154	507	86429	778	89248	514	900057	42	900101	48	90916	690

NUMBER NUMMER NUMÉRO	PAGE SEITE PAGE	NUMBER NUMMER NUMÉRO	PAGE SEITE PAGE	NUMBER NUMMER NUMÉRO	PAGE SEITE PAGE	NUMBER NUMMER NUMÉRO	PAGE SEITE PAGE	NUMBER NUMMER NUMÉRO	PAGE SEITE PAGE	NUMBER NUMMER NUMÉRO	PAGE SEITE PAGE
90917	691	92252	373	92924	708	93706	791	94388	373	94677	764
90927	691	9228	776	92925	708	93707	791	94389	373	94686	791
90967	774	92288	793	92932	706	93708	343	94438	184	94697	772
90977	776	9229	776	92933	708	93709	342	94439	184	94698	723
90978	407	9230	777	92935	706	93713	728	94442	184	94699	772
90982	663	9232	777	93003	255	93784	343	94513	741	94702	772
90984	662	92348	794	93044	738	93836	335	94547	440	94704	773
90985	662	92563	259	93046	736	93874	727	94548	440	94705	723
90986	662	92595	692	93073	342	93875	726	94584	665	94712	588
91002	262	92596	692	93076	766	93876	726	94585	664	94713	588
91004	262	92597	693	93077	766	93877	726	94586	664	94714	588
91005	263	92598	693	93078	764	93901	756	94587	664	94715	590
91006	263	92599	692	93085	698	93917	724	94589	334	94716	590
91007	263	92641	694	93092	341	93949	465	94591	334	94717	590
91236	512	92642	694	93358	697	93952	465	94592	336	94764	187
91238	745	92643	694	93359	696	93965	758	94593	336	94765	187
91242	747	92644	695	93373	392	93966	758	94605	400	94767	187
91433	262	92645	695	93374	392	94144	688	94606	400	94878	562
91496	404	92726	446	93392	464	94145	688	94609	696	94879	562
91589	245	92727	446	93394	464	94146	688	94612	593	94881	568
91971	259	92739	258	93395	466	94244	347	94613	593	94882	568
92084	676	92741	258	93397	466	94245	347	94614	593	94883	569
92085	676	92742	258	93468	404	94251	672	94616	591	94884	568
92086	676	92743	259	93625	340	94252	672	94617	591	94896	230
92087	677	92755	170	93626	340	94319	338	94618	591	94897	231
92143	522	92761	338	93672	684	94329	706	94626	566	94898	231
92146	785	92762	339	93673	684	94353	403	94635	186	94899	231
92147	785	92813	446	93674	684	94354	403	94636	186	94918	127
92206	719	92872	778	93678	686	94377	337	94637	186	94919	118
92251	372	92873	779	93679	686	94378	337	94673	764	94921	121

NUMBER NUMMER NUMÉRO	PAGE SEITE PAGE	NUMBER NUMMER NUMÉRO	PAGE SEITE PAGE	NUMBER NUMMER NUMÉRO	PAGE SEITE PAGE	NUMBER NUMMER NUMÉRO	PAGE SEITE PAGE	NUMBER NUMMER NUMÉRO	PAGE SEITE PAGE	NUMBER NUMMER NUMÉRO	PAGE SEITE PAGE
94924	128	95162	460	95385	393	95599	176	95694	769	96032	490
94925	118	95164	129	95386	735	95602	177	95695	768	96033	490
94926	122	95166	123	95482	666	95605	179	95696	768	96034	490
94935	398	95167	119	95483	666	95606	178	95725	731	96037	548
94936	398	95169	154	95484	667	95607	178	95726	731	96038	548
94938	400	95171	158	95485	666	95608	178	95755	398	96039	550
94946	719	95172	161	95487	501	95609	179	95768	552	96041	551
94958	681	95173	147	95522	209	95628	703	95774	551	96042	549
94959	681	95185	732	95523	209	95629	702	95775	746	96043	549
94961	681	95192	169	95524	209	95631	703	95776	746	96048	533
94962	680	95193	169	95525	208	95632	703	95785	745	96049	533
94963	682	95194	169	95526	208	95639	458	95787	733	96064	598
94964	682	95254	188	95527	208	95655	454	95788	733	96065	598
94965	683	95257	188	95539	716	95656	454	95789	733	96066	598
94966	682	95261	188	95541	716	95657	455	95824	695	96072	409
94967	574	95282	574	95545	652	95658	455	95912	345	96073	409
94973	503	95283	575	95546	652	95659	455	95913	344	96081	790
94987	605	95284	229	95547	653	95661	454	95914	345	96089	511
94989	602	95285	229	95548	652	95662	456	95971	482	96093	294
94995	170	95286	229	95567	287	95663	456	95972	482	96096	294
94998	573	95287	228	95568	286	95664	456	95973	482	96097	294
94999	573	95288	510	95569	285	95672	514	95975	483	96102	284
95001	573	95364	540	95576	461	95675	510	95993	560	96103	284
95044	130	95368	539	95589	181	95677	488	95994	560	96104	284
95045	130	95371	540	95591	180	95679	489	95995	560	96105	285
95055	158	95373	541	95592	180	95681	489	96002	551	96106	285
95118	128	95377	539	95593	180	95682	491	96023	492	96107	287
95119	123	95379	540	95594	181	95684	491	96024	492	96108	287
95122	119	95383	393	95597	177	95686	718	96025	487	96111	511
95147	286	95384	393	95598	177	95689	461	96026	487	96117	510

NUMBER NUMMER NUMÉRO	PAGE SEITE PAGE	NUMBER NUMMER NUMÉRO	PAGE SEITE PAGE	NUMBER NUMMER NUMÉRO	PAGE SEITE PAGE	NUMBER NUMMER NUMÉRO	PAGE SEITE PAGE	NUMBER NUMMER NUMÉRO	PAGE SEITE PAGE	NUMBER NUMMER NUMÉRO	PAGE SEITE PAGE
96178	700	96343	327	96566	530	97362	298	97574	788	97651	252
96179	700	96344	327	96567	530	97363	298	97575	785	97652	253
96181	701	96345	327	96773	326	97364	299	97577	480	97653	252
96182	700	96409	295	96774	326	97365	299	97578	481	97655	253
96183	701	96434	760	96851	501	97366	348	97583	722	97667	784
96193	190	96435	761	96866	295	97367	348	97584	722	97682	162
96194	190	96436	761	96937	582	97368	348	97587	261	97683	162
96195	190	96437	760	96938	582	97408	784	97589	261	97684	163
96199	191	96438	760	96939	582	97435	290	97604	219	97685	162
96201	191	96439	761	96957	770	97479	468	97605	218	97699	562
96211	182	96472	511	96981	394	97487	460	97606	219	97718	584
96214	183	96474	409	96982	394	97506	674	97611	108	97719	584
96219	183	96477	128	96983	394	97507	674	97612	111	97731	436
96229	571	96478	118	96985	395	97508	675	97613	109	97733	358
96231	571	96479	122	96986	395	97509	675	97614	110	97734	358
96257	182	96481	125	97044	757	97516	734	97615	108	97737	484
96258	182	96483	131	97045	757	97526	470	97616	111	97738	485
96259	183	96484	131	97054	564	97527	470	97617	109	97773	736
96261	538	96528	338	97055	564	97528	470	97618	110	97774	737
96264	539	96537	464	97056	564	97531	570	97619	108	97777	106
96305	293	96538	466	97059	600	97536	632	97621	111	97778	107
96306	290	96539	465	97066	371	97537	632	97622	109	97779	106
96307	291	96541	580	97077	707	97538	632	97633	323	97782	106
96308	290	96542	580	97078	768	97539	633	97641	132	97783	107
96325	292	96543	581	97081	594	97541	471	97642	133	97784	107
96326	292	96544	580	97082	594	97542	471	97643	132	97791	246
96327	292	96552	656	97083	594	97543	471	97644	132	97792	246
96329	291	96553	657	97209	743	97571	789	97645	134	97793	246
96331	293	96554	657	97333	743	97572	788	97646	134	97794	247
96332	293	96555	657	97361	298	97573	788	97647	134	97804	218

NUMBER NUMMER NUMÉRO	PAGE SEITE PAGE	NUMBER NUMMER NUMÉRO	PAGE SEITE PAGE	NUMBER NUMMER NUMÉRO	PAGE SEITE PAGE	NUMBER NUMMER NUMÉRO	PAGE SEITE PAGE	NUMBER NUMMER NUMÉRO	PAGE SEITE PAGE	NUMBER NUMMER NUMÉRO	PAGE SEITE PAGE
97805	218	97932	710	98139	624	98294	86	98391	716	98501	600
97806	219	97933	710	98141	625	98295	94	98393	654	98502	600
97838	468	97934	711	98142	624	98296	94	98394	654	98507	431
97839	252	97935	710	98156	436	98297	90	98395	655	98514	445
97841	388	97937	300	98192	362	98309	719	98396	654	98515	445
97845	388	97938	300	98201	91	98311	140	98397	659	98523	330
97846	389	97939	301	98203	91	98313	140	98398	658	98524	330
97854	391	97941	300	98205	90	98314	140	98399	659	98525	331
97855	391	97965	566	98206	90	98315	141	98408	659	98526	331
97857	391	97966	566	98207	88	98317	432	98409	468	98527	462
97871	472	98016	356	98208	88	98318	432	98421	536	98539	422
97872	472	98017	356	98209	88	98319	432	98422	536	98541	534
97873	472	98023	463	98212	92	98323	484	98423	536	98542	534
97874	476	98034	434	98219	87	98324	484	98424	537	98543	534
97875	476	98035	434	98223	87	98325	493	98425	537	98544	535
97876	476	98056	350	98227	85	98326	492	98426	537	98545	535
97877	474	98057	351	98228	85	98331	438	98441	362	98582	322
97878	474	98058	350	98235	87	98332	438	98446	473	98585	322
97879	474	98071	387	98236	86	98333	439	98447	477	98587	168
97881	478	98083	350	98237	86	98334	438	98448	475	98588	168
97882	478	98093	754	98247	754	98346	354	98449	479	98591	396
97883	478	98111	623	98258	489	98347	354	98453	720	98592	396
97884	570	98112	622	98263	527	98351	386	98456	387	98595	335
97885	571	98113	622	98265	527	98352	386	98458	722	98596	336
97886	524	98114	622	98277	794	98353	386	98487	463	98597	459
97895	437	98134	646	98278	741	98379	542	98488	463	98601	495
97903	437	98135	646	98279	794	98384	232	98491	424	98602	495
97904	436	98136	647	98291	322	98385	233	98492	364	98603	494
97914	759	98137	646	98292	92	98386	233	98494	424	98604	495
97915	758	98138	624	98293	92	98387	233	98495	364	98614	320

NUMBER NUMMER NUMÉRO	PAGE SEITE PAGE	NUMBER NUMMER NUMÉRO	PAGE SEITE PAGE	NUMBER NUMMER NUMÉRO	PAGE SEITE PAGE	NUMBER NUMMER NUMÉRO	PAGE SEITE PAGE	NUMBER NUMMER NUMÉRO	PAGE SEITE PAGE	NUMBER NUMMER NUMÉRO	PAGE SEITE PAGE
98615	320	98681	363	98836	365	98888	548	99053	636	99103	730
98616	320	98682	363	98837	743	98889	296	99054	636	99104	731
98617	321	98683	363	98838	382	98891	84	99069	526	99106	21
98621	644	98685	462	98839	382	98892	84	99071	370	99107	346
98622	644	98686	360	98841	531	98893	84	99072	370	99108	481
98623	644	98687	361	98842	49	98894	82	99073	370	99109	481
98624	634	98688	371	98843	55	98895	82	99074	642	99112	533
98625	634	98689	371	98844	51	98896	83	99075	642	99113	721
98626	634	98694	328	98845	56	98907	596	99076	642	99122	558
98628	344	98695	328	98846	52	98908	596	99077	196	99123	558
98629	344	98696	328	98847	58	98909	354	99078	196	99124	558
98647	319	98697	329	98849	54	99013	272	99079	196	99126	526
98648	319	98698	329	98852	57	99014	431	99081	368	99202	606
98649	319	98699	329	98854	58	99015	717	99082	368	99203	606
98651	324	98734	402	98855	762	99016	224	99083	368	99204	609
98652	324	98735	402	98856	762	99017	224	99084	741	99205	608
98653	325	98752	235	98858	358	99018	224	99086	532	99206	606
98654	325	98753	235	98859	740	99019	770	99087	532	99207	607
98655	544	98754	235	98861	426	99021	445	99089	112	99208	608
98656	544	98755	542	98862	426	99033	272	99091	113	99209	608
98657	544	98756	430	98863	426	99034	273	99092	114	99211	611
98661	353	98759	542	98864	742	99035	273	99093	227	99212	610
98662	353	98762	648	98874	268	99036	273	99094	227	99213	610
98663	353	98763	648	98875	268	99041	150	99095	227	99214	610
98674	720	98764	648	98876	268	99042	149	99096	226	99249	366
98675	430	98765	330	98877	269	99043	149	99097	226	99265	576
98676	545	98831	763	98878	269	99044	149	99098	226	99266	576
98677	597	98832	762	98881	435	99045	150	99099	21	99267	576
98678	346	98834	357	98882	435	99046	150	99101	717	99268	578
98679	431	98835	357	98887	746	99052	636	99102	717	99269	578

NUMBER NUMMER NUMÉRO	PAGE SEITE PAGE	NUMBER NUMMER NUMÉRO	PAGE SEITE PAGE	NUMBER NUMMER NUMÉRO	PAGE SEITE PAGE	NUMBER NUMMER NUMÉRO	PAGE SEITE PAGE	NUMBER NUMMER NUMÉRO	PAGE SEITE PAGE	NUMBER NUMMER NUMÉRO	PAGE SEITE PAGE
99271	578	99317	282	99358	367	99408	202	99513	212	99561	271
99272	136	99318	283	99361	450	99413	203	99514	442	99562	270
99273	136	99319	283	99362	450	99429	278	99515	442	99563	271
99274	136	99321	288	99363	450	99438	385	99516	442	99564	271
99275	139	99322	288	99364	451	99439	385	99517	640	99588	29
99276	631	99323	288	99366	238	99445	164	99518	640	99591	221
99277	631	99324	452	99367	238	99446	164	99519	640	99592	220
99278	631	99325	452	99368	238	99447	164	99523	144	99593	221
99279	139	99326	453	99369	239	99451	402	99524	142	99594	221
99285	248	99327	453	99371	236	99452	403	99525	142	99595	528
99286	248	99328	452	99372	236	99457	203	99526	144	99596	529
99287	249	99329	735	99373	237	99463	360	99527	144	99597	749
99288	248	99331	735	99374	236	99464	360	99531	359	99599	364
99289	734	99332	736	99375	274	99465	486	99532	359	99601	22
99292	200	99333	738	99376	274	99466	205	99539	154	99602	23
99293	200	99334	766	99378	274	99467	204	99541	157	99603	22
99294	200	99335	767	99381	276	99468	204	99542	160	99604	23
99295	201	99339	587	99382	276	99469	205	99543	146	99605	23
99296	201	99341	480	99383	276	99486	166	99544	210	99606	552
99297	599	99342	480	99384	277	99487	166	99545	210	99607	552
99298	112	99343	486	99395	422	99488	628	99546	211	99608	553
99299	112	99344	486	99397	500	99489	628	99547	211	99609	553
99301	113	99345	216	99398	500	99491	628	99548	40	99611	167
99302	113	99346	216	99399	501	99492	629	99549	40	99612	166
99303	114	99347	217	99401	366	99506	217	99551	214	99613	142
99304	114	99348	524	99403	366	99507	217	99552	214	99614	316
99313	318	99349	524	99404	488	99508	469	99553	214	99615	316
99314	318	99353	203	99405	488	99509	469	99554	215	99616	316
99315	282	99356	458	99406	494	99511	212	99555	215	99617	317
99316	282	99357	458	99407	494	99512	212	99559	296	99618	377

NUMBER NUMMER NUMÉRO	PAGE SEITE PAGE	NUMBER NUMMER NUMÉRO	PAGE SEITE PAGE	NUMBER NUMMER NUMÉRO	PAGE SEITE PAGE	NUMBER NUMMER NUMÉRO	PAGE SEITE PAGE
99619	377	99673	26	99731	596	99805	281
99621	498	99674	26	99772	612	99806	222
99622	498	99675	26	99773	612	99807	222
99623	498	99676	28	99774	612	99808	223
99624	202	99677	28	99776	586	99809	222
99625	204	99684	64	99777	586	99811	357
99628	333	99685	65	99778	586	99817	422
99629	333	99686	64	99779	496	99818	367
99631	234	99687	64	99781	497	99819	361
99632	234	99689	530	99782	496	99821	361
99633	374	99691	585	99783	496	99822	721
99634	374	99692	584	99784	420	99824	739
99635	375	99693	380	99785	420	99825	738
99636	374	99694	380	99786	420	99828	755
99639	40	99695	381	99787	419	99829	755
99651	332	99696	381	99788	418	99831	756
99654	332	99697	369	99789	419	99832	756
99655	428	99698	369	99791	421	99838	614
99656	428	99699	493	99792	419	99839	614
99659	425	99701	397	99793	424	99853	614
99661	378	99702	397	99794	749	99854	615
99662	378	99703	499	99795	198	99855	198
99663	399	99704	499	99796	199	99856	198
99664	435	99705	376	99797	199		
99665	379	99706	376	99798	199		
99666	379	99707	376	99799	280		
99667	443	99711	638	99801	280		
99669	27	99712	638	99802	280		
99671	27	99713	638	99803	281		
99672	27	99715	720	99804	281		



NOTES

NOTIZEN
NOTES

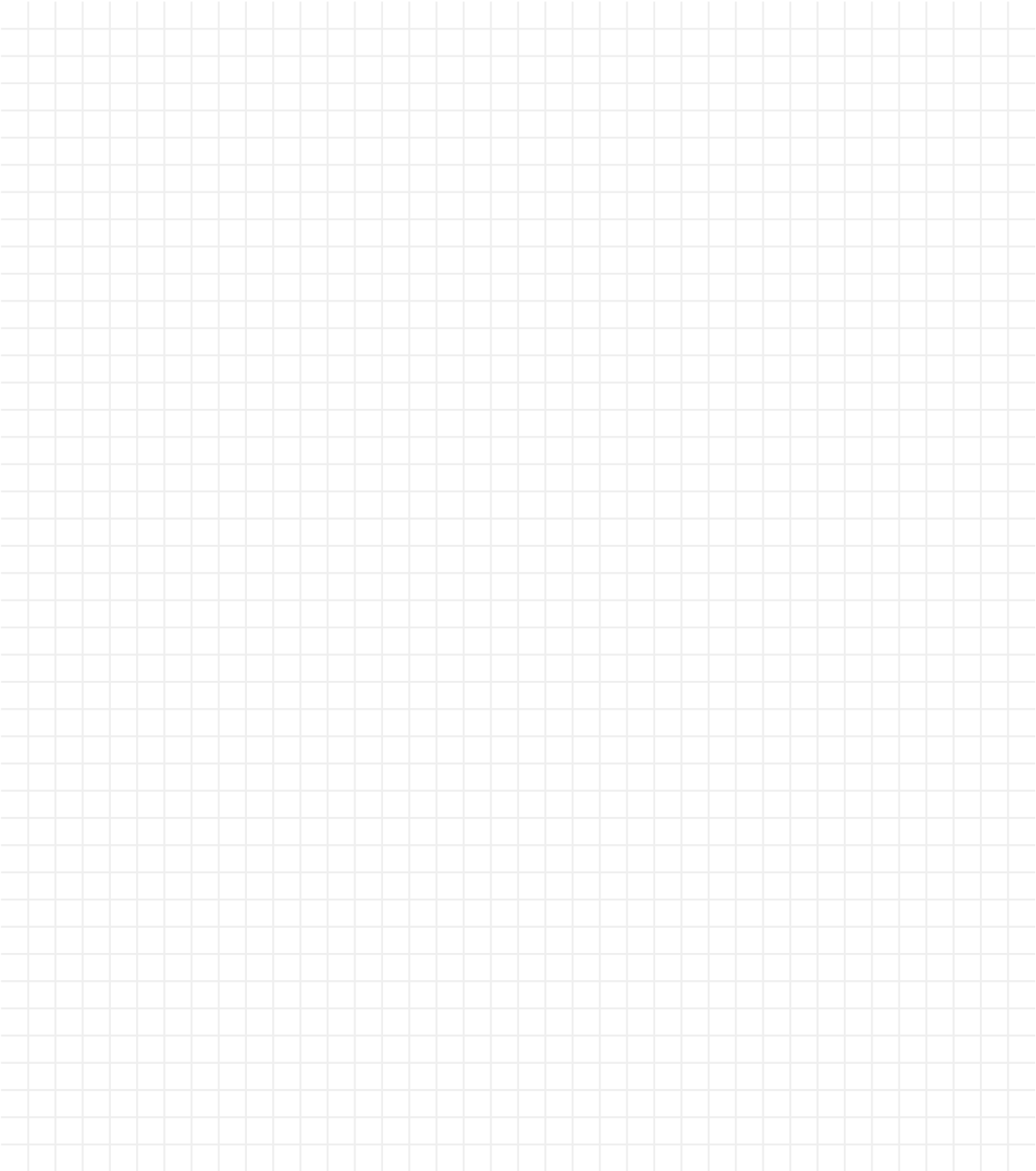

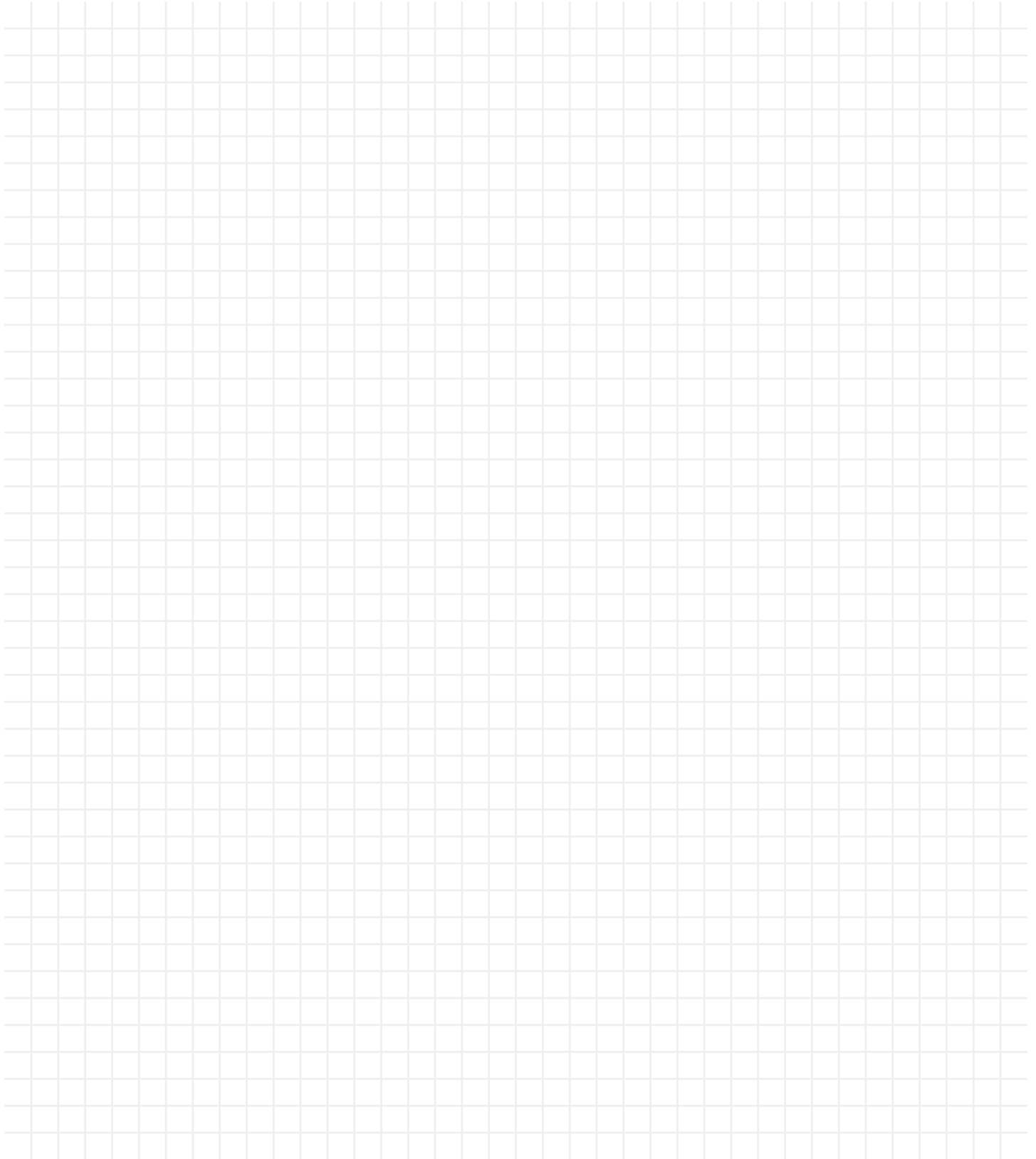

All previous catalogues and price lists are no longer valid with the issue of this catalogue. Errors, misprints, model and price changes and technical modifications are reserved. We deliver based on our terms of delivery and payment. Our products comply with the European light norm EN60598. Products with the ENEC test mark are conforming to the guide line 2006/95/EG. Products with additional safety remarks (e.g protection class, IP) are identified within the product family with the relevant symbol and number. The content of this catalogue is protected under copyright law for EGLO Leuchten GmbH. All rights reserved. Our specific written consent must be obtained before using any illustrations and texts. The pictures are 4C prints and may differ from the original. The product pictures and ambiances in this catalogue can deviate from reality, and they do not necessarily concur with the usual application of the product. EGLO does not assume liability for the correctness, completeness or the application depiction of the products and/or the product information. Design, layout and composition: EGLO GmbH, A-6136 Pill - AUSTRIA Print: Samson Druck GmbH, 5581 St. Margarethen - AUSTRIA Pictures: EGLO, Adobe Stock, istockphoto.com

Mit diesem Katalog verlieren alle vorhergehenden Kataloge und Preislisten ihre Gültigkeit. Irrtümer, Druckfehler, Modell- und Preisänderungen sowie technische Änderungen vorbehalten. Wir liefern zu unseren Liefer- und Zahlungsbedingungen. Unsere Produkte entsprechen der europäischen Leuchtnorm EN 60598. Produkte mit dem ENEC Prüfzeichen sind konform mit der Richtlinie 2006/95/EG. Produkte mit weiteren Sicherheitshinweisen (zB. Schutzklasse, IP) sind mit Symbol und Zahl bei der Produktfamilie ausgezeichnet. Der Inhalt dieses Kataloges ist für die EGLO Leuchten GmbH urheberrechtlich geschützt. Alle Rechte sind vorbehalten. Bilder und Texte dürfen nicht ohne vorherige ausdrückliche, schriftliche Genehmigung verwendet werden. Die Abbildungen sind 4C Drucke und können vom Original abweichen. Die Katalogbilder und die gezeigten Darstellungen der Produkte können von der Wirklichkeit abweichen und nicht den üblichen Produktanwendungen entsprechen. EGLO übernimmt keine Haftung für die Richtigkeit, Vollständigkeit und Anwendungsdarstellung der Produkte und Produktinformationen. Gestaltung, Layout und Satz: EGLO GmbH, A-6136 Pill - AUSTRIA Druck: Samson Druck GmbH, 5581 St. Margarethen - AUSTRIA Bilder: EGLO, Adobe Stock, istockphoto.com

Le présent catalogue remplace tous les catalogues et tarifs précédents. Sous réserve d'erreurs, de fautes d'impression, de modification des modèles et de changement de prix et de technique. Nous livrons sur la base de nos conditions de livraison et de paiement. Nos produits sont conformes aux normes européennes EN 60598 et portent le marquage CE. Les produits portant la marque ENEC sont conformes à la Directive 2006/95/EG. Les produits portant d'autres indications de sécurité (par exemple classe de protection, IP) sont identifiés par le symbole et le nombre correspondants dans la famille de produits. Le contenu du présent catalogue est protégé pour la société EGLO Leuchten GmbH par un copyright. Tous droits réservés. Toute reproduction d'images et du texte est interdite sans autorisation explicite par écrit préalable. Les images sont imprimées en 4C et peuvent différer de l'original. Les images des produits et les ambiances dans le catalogue peuvent dévier de la réalité et ne sont pas nécessairement en ligne avec l'usage habituel du produit. EGLO n'engage pas sa responsabilité sur la justesse des images et sur les informations relatives à l'usage pouvant être fait des produits. Conception, maquette et composition: EGLO GmbH, A-6136 Pill - AUSTRIA Presse: Samson Druck GmbH, 5581 St. Margarethen - AUSTRIA Images: EGLO, Adobe Stock, istockphoto.com

06-2021



EGLO Leuchten GmbH
Heiligkreuz 22
A-6136 Pill
Austria
Tel. +43 (0) 5242 6996
Fax +43 (0) 5242 6996-972
info@eglo.com
www.eglo.com

my light | my style

KAT-21