



**EGLO**  
my light | my style



**2021/22**

**TECHNICAL LIGHT SOLUTIONS**

TECHNISCHE LICHTLÖSUNGEN  
SOLUTIONS D'ÉCLAIRAGE TECHNIQUE





Dear reader,

Welcome to our extensive range of technical lighting systems! The hallmarks of this range are sleek shapes and minimalist designs paired with superb illumination and a broad range of user-friendly controls... along with many other features you'll love.

To highlight two things we've been working on this year: we've extended our rail system for flexible lighting options in living spaces, and added to our range of LED panels with wooden frames that not only provide great illumination but also create a delightful homely atmosphere.

Liebe Leserin, lieber Leser,

auf den folgenden Seiten erwartet Sie unser umfangreiches Sortiment an technischen Lichtlösungen. Schlanke Bauformen, reduzierte Designs sowie gute Ausleuchtung sind neben den unterschiedlichen und praktischen Steuerungsmöglichkeiten nur ein Teil der Eigenschaften, die dieses Sortiment ausmachen.

Ergänzt haben wir in diesem Jahr insbesondere unsere Schienensysteme zur flexiblen Lichtgestaltung in Wohnräumen sowie LED Panel mit Holzrahmen, die neben ihrer guten Raumausleuchtung durch ihren wohnlichen Charakter bestechen.

Chère lectrice, cher lecteur,

Dans les pages suivantes, vous trouverez notre vaste gamme de solutions d'éclairage technique. Outre ses différentes options de commande très pratiques, cette gamme se caractérise aussi par des formes élancées, des designs minimalistes et une bonne qualité d'éclairage.







Cette année, nous avons notamment parfait nos systèmes de rails pour un agencement flexible de l'éclairage dans les espaces de vie ainsi que nos panneaux LED avec des châssis en bois, qui séduisent non seulement par leur qualité d'éclairage mais aussi par leur caractère convivial.





# CONTENTS

INHALT  
CONTENU

	<b>EGLO CONNECT</b>	4-45
	<b>EGLO ACCESS</b>	46-59
 <b>RECESSED &amp; SURFACE LUMINAIRES</b>	<b>LED PANEL LUMINAIRES</b> LED PANEELLEUCHTEN LUMINAIRES LAMBRIS LED  DECORATIVE BASIC FRAMELESS WITH SUSPENSION FRAME DIMMABLE WOOD FRAME	60-109
	<b>RECESSED LUMINAIRES</b> EINBAULEUCHTEN ENCASTRABLES  HIGH VOLTAGE FUEVA 5 FUEVA FLEX LOW VOLTAGE EGLO TRACK SYSTEMS WITH BULBS	110-213
	<b>SURFACE LUMINAIRES</b> AUFBAULEUCHTEN LUMINAIRES EN SAILLIE  FUEVA DECORATIVE	214-257
	<b>LED STRIPES</b>	258-265
	<b>LED PROFILES</b>	266-309
	<b>LEGEND &amp; REGISTER</b>	310-320

# connect.2

































































# Discover the smart world







# OVERVIEW

							
REMOTE 2.0 p. 15	SALICETO-Z p. 17	SALICETO-Z p. 17	SALICETO-Z p. 17	TURCONA-Z p. 18	TURCONA-Z p. 18	TURCONA-Z p. 18	HERRORA-Z p. 20
							
HERRORA-Z p. 20	HERRORA-Z p. 20	TURCONA-Z p. 22	TURCONA-Z p. 22	TURCONA-Z p. 22	TURCONA-Z p. 23	TURCONA-Z p. 23	SALOBRENA-Z p. 24
							
SALOBRENA-Z p. 24	SALOBRENA-Z p. 24	SALOBRENA-Z p. 25	SALOBRENA-Z p. 25	SALOBRENA-Z p. 26	SALOBRENA-Z p. 26	SALOBRENA-Z p. 26	SALOBRENA-Z p. 27
							
SALOBRENA-Z p. 27	FUEVA-Z p. 28	FUEVA-Z p. 28	FUEVA-Z p. 28	FUEVA-Z p. 29	FUEVA-Z p. 30	FUEVA-Z p. 30	FUEVA-Z p. 30
							
FUEVA-Z p. 31	FUEVA-Z p. 32	FUEVA-Z p. 32	FUEVA-Z p. 32	FUEVA-Z p. 33	FUEVA-Z p. 34	FUEVA-Z p. 34	FUEVA-Z p. 34
							
FUEVA-Z p. 35	FUEVA-Z p. 36	FUEVA-Z p. 36	FUEVA-Z p. 36	FUEVA-Z p. 37	FUEVA-Z p. 38	FUEVA-Z p. 38	FUEVA-Z p. 38
							
FUEVA-Z p. 39	ROVITO-Z p. 40	ROVITO-Z p. 40	ROVITO-Z p. 40	ROVITO-Z p. 41	ROVITO-Z p. 42	ROVITO-Z p. 42	ROVITO-Z p. 42
							
ROVITO-Z p. 43	LED STRIPE-Z p. 44	LED STRIPE-Z p. 44	LED STRIPE-Z p. 44	LED STRIPE-Z p. 45			

## connect.z combines two control technologies in one system

connect.z vereint zwei Steuerungstechnologien in einem System

connect.z réunit deux technologies de commande au sein d'un même système



ZigBee is far and away the most widely used standard in the smart home world.

ZigBee ist der am weitesten verbreitete Standard in der Smart Home Welt.

ZigBee est le protocole le plus répandu au monde dans le domaine du Smart Home.

### ADVANTAGES :

- › Mesh network
- › Direct connection with Amazon Echo and Google Home
- › Compatible with products from different manufacturers
- › High level of security
- › Easy setup
- › Energy efficient

### VORTEILE:

- › Mesh-Netzwerk
- › Direkte Verbindung mit Amazon Echo und Google Home
- › Herstellerübergreifend kompatibel
- › Hohe Sicherheit
- › Einfache Einrichtung
- › Energieeffizient

### AVANTAGES:

- › Réseau maillé
- › Connexion directe à Amazon Echo et Google Home
- › Compatible indépendamment du fabricant
- › Sécurité élevée
- › Installation facile
- › Économe en énergie

# connect.2



Bluetooth is an established standard in the digital world.  
Bluetooth ist ein etablierter Standard in der digitalen Welt.  
Bluetooth est un standard de communication reconnu dans le monde numérique.

#### ADVANTAGES:

- › Local & secure network
- › Protocol is mainly audio (low debit)
- › Mesh network: Elements are receivers and senders
- › Easy setup
- › Usable offline
- › Energy efficient

#### VORTEILE:

- › Lokales & sicheres Netzwerk Protokoll hauptsächlich Audio (Low Debit)
- › Mesh-Netzwerk: Elemente sind Empfänger und Sender
- › Einfache Einrichtung
- › Offline nutzbar
- › Energieeffizient

#### AVANTAGES:

- › Réseau local et sûr
- › Protocole essentiellement audio (bas débit)
- › Réseau maillé : les éléments sont l'émetteur et le récepteur
- › Installation facile
- › Utilisable hors-ligne
- › Économe en énergie



# Light up your world!

Bringen Sie Licht in Ihren Alltag!  
Illuminez votre quotidien !



connect.z offers a wide range of lamps and lighting equipment. Select products from the following options according to your needs:  
connect.z bietet ein großes Sortiment an Leuchten und Leuchtmitteln. Wählen Sie die Produkte ganz nach Ihren Bedürfnissen aus folgenden Varianten:  
connect.z propose une large gamme de luminaires et d'ampoules. Sélectionnez les produits en fonction de vos besoins parmi les variantes suivantes :

**Warm White**

**Neutral White**

**Tunable White**

Individual light from 50,000 white tones.  
Individuelles Licht aus 50.000 Weißtönen.  
Luminaire individuel à 50 000 tons de blanc.

**TW + RGB Colors**

Diverse lighting selection from 50,000 white tones and 16 million colours.  
Vielseitige Lichtauswahl aus 50.000 Weißtönen und 16 Mio. Farben.  
Sélection étendue de luminaires à 50 000 tons de blanc et 16 millions de couleurs.

Enjoy relaxing moments!  
Genießen Sie entspannte Momente!  
Profitez de moments de détente !

Stay focussed & efficient!  
Bleiben Sie konzentriert & leistungsfähig!  
Restez concentré(e) et performant(e) !

Start the day fresh every morning!  
Starten Sie jeden Morgen frisch in den Tag!  
Commencez la journée du bon pied !

Create the perfect atmosphere!  
Kreieren Sie Ihr perfektes Ambiente!  
Créez votre ambiance parfaite !





## Enjoy many useful convenience features:

Es erwarten Sie viele nützliche Komfortfunktionen:  
De nombreuses fonctionnalités utiles vous attendent pour votre confort :



### TIMERS AND CALENDARS / TIMER UND ZEITPLÄNE/ MINUTERIE ET CALENDRIER

Make your daily life easier with timers and calendars.  
Wake up relaxed with the simulated sunrise.

Unterstützen Sie Ihren Alltag mit Timern und Zeitplänen. Entwickeln Sie eigene Lichtroutinen und machen Sie Ihr Leben leichter.

Facilitez-vous la vie à l'aide de la fonction minuterie et calendrier.  
Réveillez-vous en douceur grâce au simulateur de lever de soleil



### LIGHT ALARM CLOCK/ LICHTWECKER/ REVEIL LUMINEUX

You'd rather not start your day in a bad mood? Wake up relaxed with the simulated sunrise.

Keine Lust mit schlechter Laune in den Tag zu starten? Entspannt aufwachen mit dem simulierten Sonnenaufgang.

Pas envie de commencer la journée de mauvaise humeur ? Réveillez-vous en douceur grâce au simulateur de lever de soleil.



### DISCO FUNCTION/MODE/ DISCOFUNKTION/MODUS/ FONCTION/MODE DISCO

For the perfect party mood, the disco function synchronises the light to the beat of your favourite songs.

Für die perfekte Partystimmung schaltet die Discofunktion das Licht passend zum Beat Ihres Lieblingsongs.

Pour une ambiance festive parfaite, la fonction disco enclenche le luminaire au rythme de votre chanson préférée.



### PRESENCE SIMULATOR/ ANWESENHEITSSIMULATION/ SIMULATEUR DE PRESENCE

Protect your home with the convenient presence simulator. Variable time intervals allow the system to turn the lights on and off to simulate your presence at home and deter unwanted guests.

Schütze Sie Ihr Zuhause mit der komfortablen Anwesenheitssimulation. Dank variabler Zeitintervalle simuliert das System durch Ein- und Ausschalten der Beleuchtung die Anwesenheit im Haus und schreckt so ungebetene Gäste ab.

Protégez votre domicile à l'aide du très pratique simulateur de présence. Le système simule votre présence en allumant et en éteignant les lumières à intervalles variables et décourage ainsi les invités indésirables.

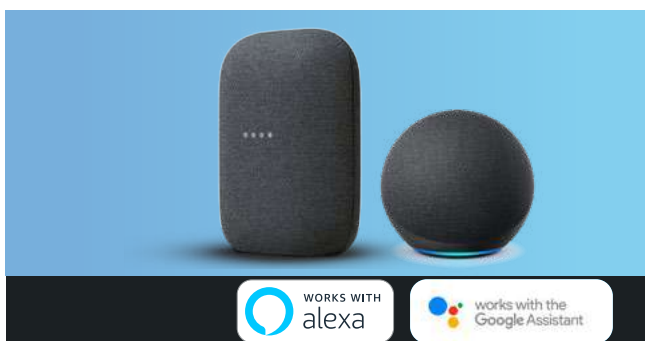

### VOICE COMMANDS/ SPRACHSTEUERUNG/COMMANDE VOCALE

More convenient! Turn the light on whenever you want with only a voice command.

Noch komfortabler! Mit nur einem Sprachbefehl schaltet sich das Licht nach Ihren Wünschen an und aus.

C'est encore plus confortable ! Allumez votre luminaire comme vous le souhaitez d'une simple commande vocale.

## Control options

Steuerungsmöglichkeiten  
Possibilités de commande



Set your smart home as you prefer! With the app, voice commands, or remote control.

Steuern Sie Ihr Smart Home wie Sie es möchten! Via App, Sprachsteuerung oder mit der Fernbedienung.

Commandez votre Smart Home comme vous le souhaitez ! Via l'appli, la commande vocale ou la télécommande.



### APP CONTROL

Use the free app for smartphone, tablet, or smartwatch.

Nutzen Sie die kostenlose App für das Smartphone, Tablet oder die Smartwatch.

Utilisez l'appli gratuite sur votre smartphone, votre tablette ou votre montre connectée.



### VOICE COMMANDS

Use intelligent voice assistants such as Google Home and Amazon Alexa.

Nutzen Sie intelligente Sprachassistenten wie Google Home und Amazon Alexa.

Utilisez des assistants vocaux intelligents comme Google Home ou Amazon Alexa.



### REMOTE CONTROL

Use the practical remote connect.z operation at any time.

Nutzen Sie auch jederzeit die praktische connect.z Fernbedienung.

Vous pouvez aussi utiliser à tout moment la télécommande connect.z.



### CONNECT.Z ACCESSORIES

Use clever accessories such as the movement sensor and much more.

Nutzen Sie cleveres Zubehör wie z.B. den Bewegungssensor uvm.

Utilisez des accessoires malins tels que le capteur de mouvement et bien d'autres encore.



### DIMMER FUNCTION

Use the practical dimmer function via app, speech command or remote control.

Nutzen Sie die praktische Dimmfunktion via App, Sprachbefehl oder Fernbedienung.

Utilisez la fonction de gradation via l'appli, la commande vocale ou la télécommande.

# One system, many possibilities!

Ein System – viele Möglichkeiten!

Un système, de nombreuses possibilités!

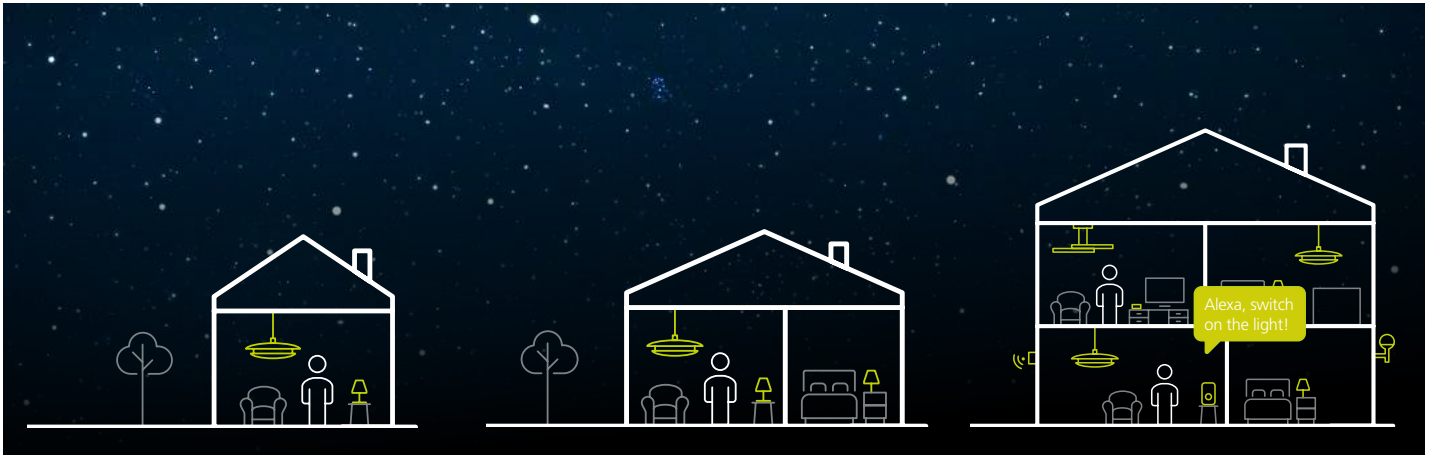

No matter how you start, you can integrate new products into your connect.z system at any time and gradually expand your smart home. Egal wie Sie starten, Sie können jederzeit neue Produkte in Ihr connect.z System integrieren und Ihr smartes Zuhause nach und nach erweitern. Quel que soit votre choix, vous pouvez à tout moment intégrer de nouveaux produits à votre système connect.z et améliorer progressivement votre maison intelligente.

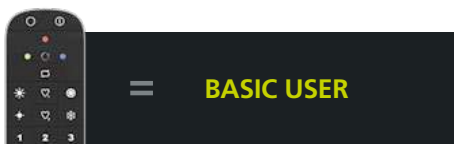

**BASIC USER**

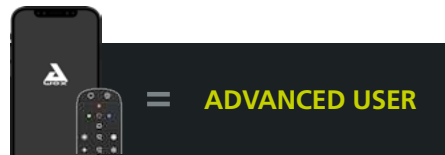

**ADVANCED USER**



**POWER USER**

All you need to start is a connect.z product and the remote control. No internet connection is required and you have access to:

Sie benötigen zum Start lediglich ein connect.z Produkt und die Fernbedienung. Es wird kein Internetzugang benötigt und Sie haben Zugriff auf:

Pour démarrer, il vous suffit d'un produit connect.z et de la télécommande. Aucune connexion Internet n'est nécessaire. Vous avez accès aux :

## Standard functions: Standardfunktionen: Fonctionnalités standard :

- › Select colour/ Farbauswahl/ sélection de couleur
- › Change colour/ Farbwechsel/ changement de couleur
- › Dim/ Dimmen/ gradation
- › Favourites (2x)/ Favoriten (2x)/ favoris (2x)
- › Groups (3x)/ Gruppen (3x)/ groupes (3x)
- › Candle mode/ Kerzenmodus/ mode bougie

Besides the standard functions, would you also like access to the practical convenience features? Then you need only your smartphone or tablet and the Awox app. This app allows you to control your lights via WIFI and Bluetooth®.

Sie möchten zu den Standardfunktionen auch noch Zugriff auf die praktischen Komfortfunktionen haben? Dann benötigen Sie nur Ihr Smartphone oder Tablet und die Awox App. Mit der App haben Sie die Möglichkeit, Ihre Leuchten über WLAN und Bluetooth® zu steuern.

Outre les options standard, vous souhaitez également pouvoir utiliser les fonctionnalités de confort les plus pratiques ? Pour cela, vous avez seulement besoin de votre smartphone ou de votre tablette et de l'appli Awox. L'appli vous permet de commander vos luminaires via le réseau Wi-Fi ou Bluetooth®.

## Standard functions + convenience features/ Standardfunktionen + Komfortfunktionen / Fonctionnalités standard + confort

- › Light alarm clock/ Lichtwecker/ réveil lumineux
- › Presence simulation/ Anwesenheitssimulation/ simulateur de présence
- › Disco function/ Discofunktion/ fonction disco
- › Timers & timetables /Timer & Zeitpläne/ minuteur et calendrier
- › Accessories can be incorporated/ Einbindung von Zubehör möglich/ connexion d'accessoires possible

Use the system's full potential and control your smart home through the Awox app using WIFI or Bluetooth® as well as integrating a voice assistant into the system. This gives you:

Nutzen Sie das volle Potenzial des Systems und steuern Sie Ihr Smart Home über die Awox App mithilfe von WLAN oder Bluetooth® und integrieren Sie zusätzlich noch einen Sprachassistenten in das System. So mit erhalten Sie:

Exploitez tout le potentiel du système en commandant votre Smart Home grâce à l'appli Awox via le réseau Wi-Fi ou Bluetooth®, et intégrez également un assistant vocal au système. Vous obtenez ainsi :

## Standard functions + convenience features + voice commands\*

## Standardfunktionen + Komfortfunktionen + Sprachsteuerung\*

## Fonctionnalités standard + confort + commande vocale\*

- › Amazon Alexa or Google Home/ Amazon Alexa oder Google Home/ Amazon Alexa ou Google Home

- \* Use a voice assistant with integrated bridge.
- \* Nutzen Sie einen Sprachassistenten mit integrierter Bridge.
- \* Utilisez un assistant vocal avec Bridge intégré.

## YOU ALREADY HAVE CONNECT-C LUMINAIRES FROM THE PREVIOUS SYSTEM! WHAT NOW?

Sie besitzen bereits connect-c Leuchten des Vorgängersystems! Was nun?  
Vous disposez déjà de luminaires connect-c de l'ancien système! Que faire ?

No problem! The previous connect-c products are compatible with the new connect.z system.  
Kein Problem! Die bisherigen connect-c Produkte sind mit dem neuen connect.z System kompatibel.  
Aucun problème! Les anciens produits connect-c sont compatibles avec le nouveau système connect.z.

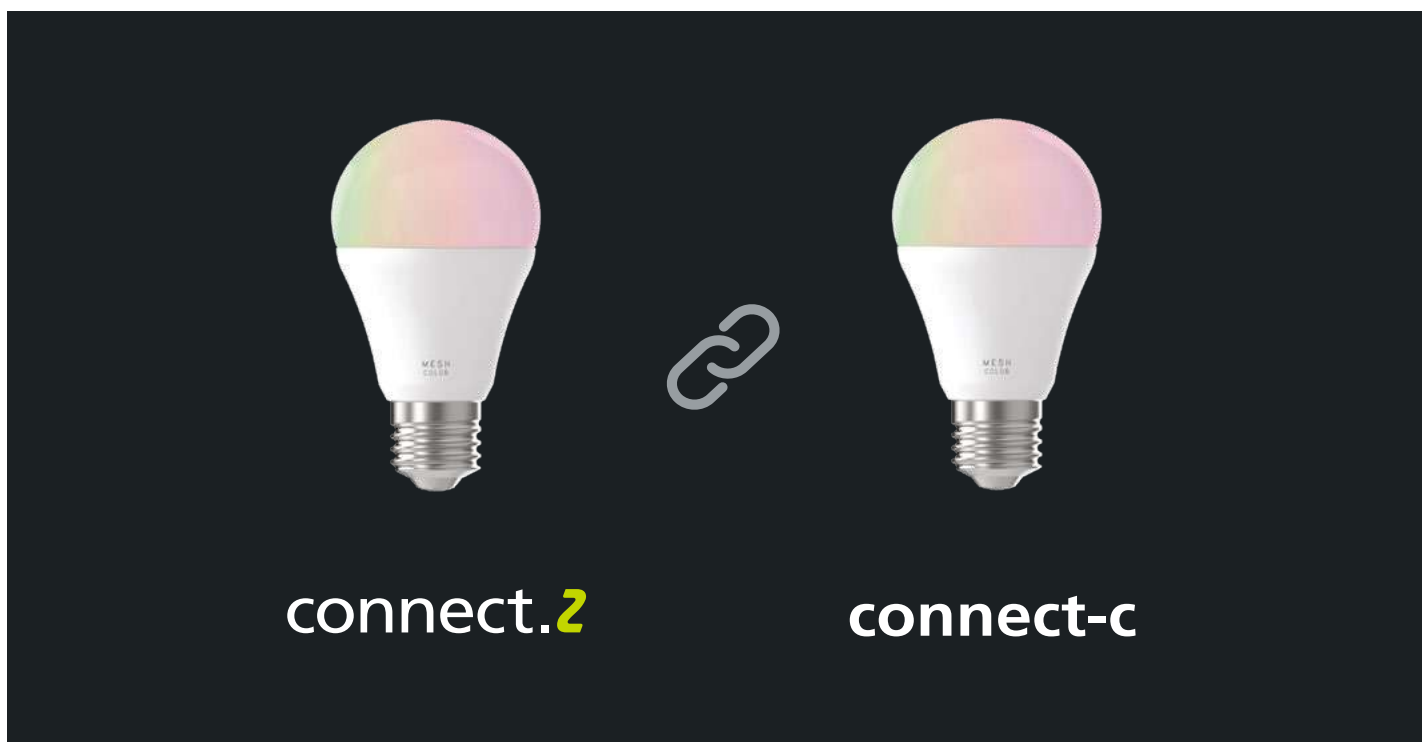

**EGLO connect-c - connect.z**  
The existing EGLO connect-c system is compatible with the new EGLO connect.z system. You don't need to switch from the existing Bluetooth low energy system to the new open protocol ZigBee 3.0. Lights from EGLO connect-c can be incorporated into the existing EGLO connect.z system.

**EGLO connect-c - connect.z**  
Das bestehende EGLO connect-c System ist mit dem neuen EGLO connect.z System kompatibel. Sie müssen nicht von dem bestehendem Bluetooth low energy System auf das neue offene Protokoll ZigBee 3.0 umsteigen. Leuchten von EGLO connect-c können in das bestehende EGLO connect.z System eingebunden werden.

**EGLO connect-c - connect.z**  
Le système EGLO connect-c existant est compatible avec le nouveau système EGLO connect.z. Vous n'avez pas besoin de passer du système Bluetooth à basse consommation existant au nouveau protocole ouvert ZigBee 3.0. Les luminaires EGLO connect-c peuvent être intégrés au système EGLO connect.z existant.





**99099**

### 99099 REMOTE 2.0

remote control; plastic, grey  
Fernbedienung; Kunststoff, grau  
Télécommande; plastique, gris

L 122, B 54, H 18



ACCU  
AAA,  
R03P



1,5V



9 002759 990992





99669





99669



99672



99671



### 99669 SALICETO-Z

recessed light; aluminium, black  
 Einbauleuchte; Alu, schwarz  
 luminaire encastrable; aluminium, noir

H 46, Ø 88, ET 50



### 99671 SALICETO-Z

recessed light; aluminium, white  
 Einbauleuchte; Alu, weiss  
 luminaire encastrable; aluminium, blanc

H 46, Ø 88, ET 50

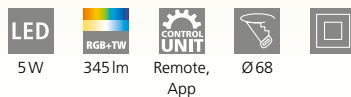

### 99672 SALICETO-Z

recessed light; aluminium, satin nickel  
 Einbauleuchte; Alu, nickel-matt  
 luminaire encastrable; aluminium, nickel mat

H 46, Ø 88, ET 50

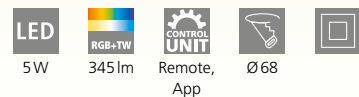



900054



900055



900056



### 900054 TURCONA-Z

ceiling light; steel, aluminium, white / plastic, white  
Deckenleuchte; Stahl, Alu, weiss / Kunststoff, weiss  
plafonnier; acier, aluminium, blanc / plastique, blanc

H 60, Ø 300

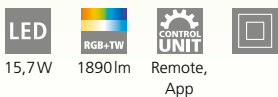

15,7W 1890lm Remote, App



9 008606 221905



Ø 300

### 900055 TURCONA-Z

ceiling light; steel, aluminium, white / plastic, white  
Deckenleuchte; Stahl, Alu, weiss / Kunststoff, weiss  
plafonnier; acier, aluminium, blanc / plastique, blanc

H 60, Ø 450



22,4W 2690lm Remote, App



9 008606 221912



Ø 450

### 900056 TURCONA-Z

ceiling light; steel, aluminium, white / plastic, white  
Deckenleuchte; Stahl, Alu, weiss / Kunststoff, weiss  
plafonnier; acier, aluminium, blanc / plastique, blanc

H 60, Ø 600



34,2W 4100lm Remote, App



9 008606 221929

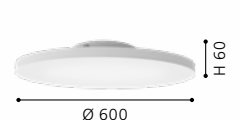

Ø 600





900055

LED



Travel makes  
you realize that  
no matter how  
much you know,  
there's always  
more to learn.





99639



99548



99549



### 99639 HERRORA-Z

ceiling light; aluminium, white / plastic, white  
Deckenleuchte; Alu, weiss / Kunststoff, weiss  
plafonnier; aluminium, blanc / plastique, blanc

L 450, B 450, H 40



### 99548 HERRORA-Z

ceiling light; aluminium, white / plastic, white  
Deckenleuchte; Alu, weiss / Kunststoff, weiss  
plafonnier; aluminium, blanc / plastique, blanc

L 595, B 595, H 40



### 99549 HERRORA-Z

ceiling light; aluminium, white / plastic, white  
Deckenleuchte; Alu, weiss / Kunststoff, weiss  
plafonnier; aluminium, blanc / plastique, blanc

L 1200, B 300, H 40



9 002759 996390



9 002759 995485



9 002759 995492





99639

LED





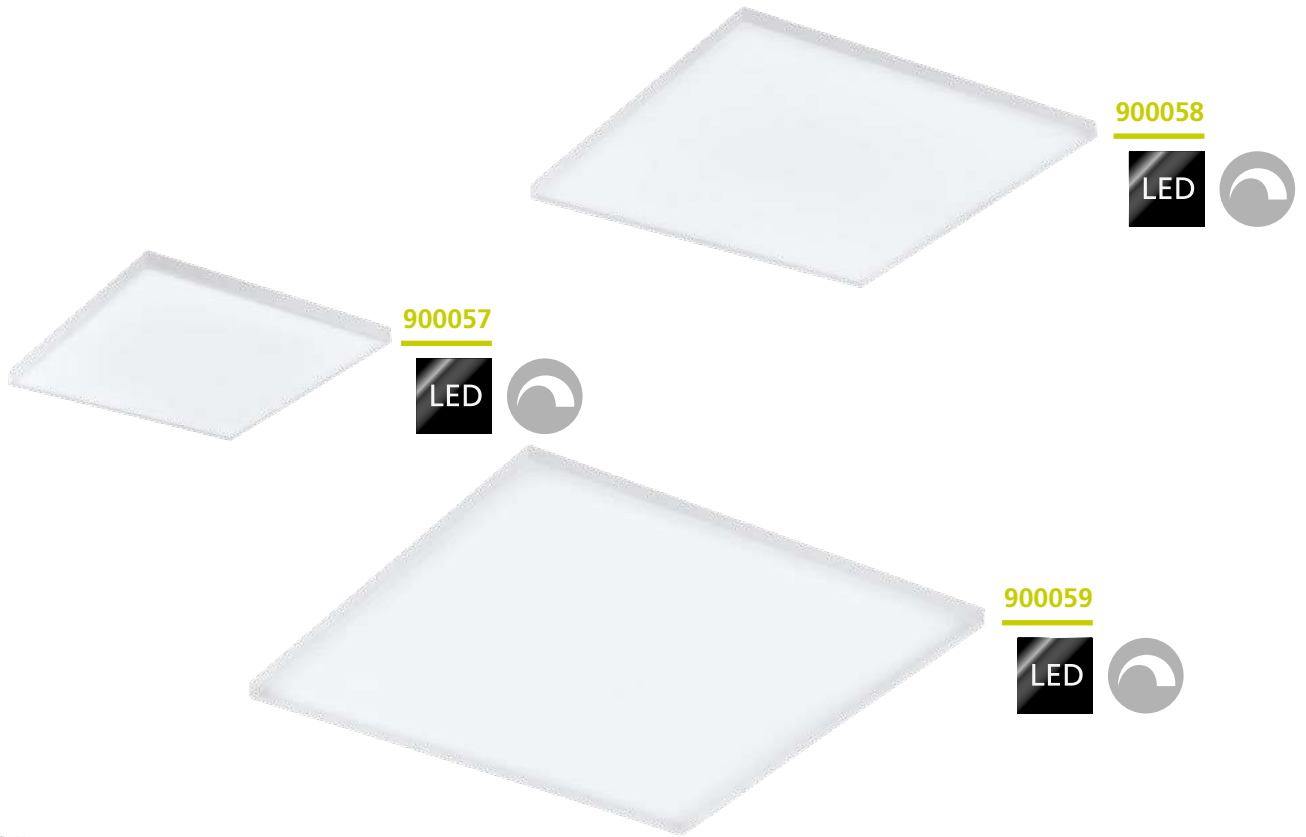

## TURCONA-Z

Frameless luminaire

Rahmenlose Leuchte

Luminaire sans cadre

### 900057 TURCONA-Z

ceiling light; steel, aluminium, white / plastic, white  
Deckenleuchte; Stahl, Alu, weiss / Kunststoff, weiss  
plafonnier; acier, aluminium, blanc / plastique, blanc

L 300, B 300, H 50



16W 1940lm

### 900058 TURCONA-Z

ceiling light; steel, aluminium, white / plastic, white  
Deckenleuchte; Stahl, Alu, weiss / Kunststoff, weiss  
plafonnier; acier, aluminium, blanc / plastique, blanc

L 450, B 450, H 50

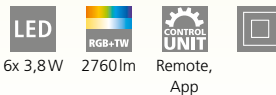

6x 3,8W 2760lm

### 900059 TURCONA-Z

ceiling light; steel, aluminium, white / plastic, white  
Deckenleuchte; Stahl, Alu, weiss / Kunststoff, weiss  
plafonnier; acier, aluminium, blanc / plastique, blanc

L 600, B 600, H 50



6x 5,4W 4260lm



9 008606 221936



9 008606 221943

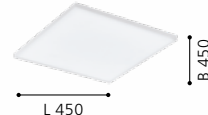

9 008606 221950

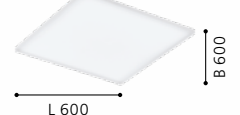



900061



900062



900061



### 900062 TURCONA-Z

ceiling light; steel, aluminium, white / plastic, white  
Deckenleuchte; Stahl, Alu, weiss / Kunststoff, weiss  
plafonnier; acier, aluminium, blanc / plastique, blanc

L 1200, B 100, H 50



34,2W



4060lm



Remote,  
App



### 900061 TURCONA-Z

ceiling light; steel, aluminium, white / plastic, white  
Deckenleuchte; Stahl, Alu, weiss / Kunststoff, weiss  
plafonnier; acier, aluminium, blanc / plastique, blanc

L 1200, B 300, H 50



3x 10,6W



4000lm



Remote,  
App



9 008606 221974

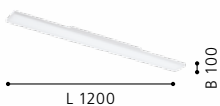

9 008606 221967

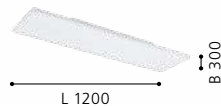



900044



900045



900046



### 900044 SALOBRENA-Z

ceiling light; aluminium, white / plastic, white  
Deckenleuchte; Alu, weiss / Kunststoff, weiss  
plafonnier; aluminium, blanc / plastique, blanc

L 300, B 300, H 50

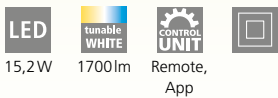

15,2W 1700lm Remote, App

### 900045 SALOBRENA-Z

ceiling light; aluminium, white / plastic, white  
Deckenleuchte; Alu, weiss / Kunststoff, weiss  
plafonnier; aluminium, blanc / plastique, blanc

L 450, B 450, H 50

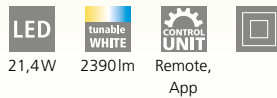

21,4W 2390lm Remote, App

### 900046 SALOBRENA-Z

ceiling light; aluminium, white / plastic, white  
Deckenleuchte; Alu, weiss / Kunststoff, weiss  
plafonnier; aluminium, blanc / plastique, blanc

L 595, B 595, H 50

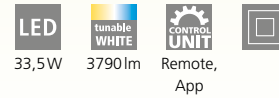

33,5W 3790lm Remote, App



9 008606 221813



9 008606 221820



9 008606 221837







900047



900048



**900047 SALOBRENA-Z**

ceiling light; aluminium, white / plastic, white  
Deckenleuchte; Alu, weiss / Kunststoff, weiss  
plafonnier; aluminium, blanc / plastique, blanc

L 1200, B 300, H 50

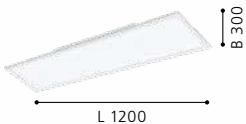

**900048 SALOBRENA-Z**

ceiling light; aluminium, white / plastic, white  
Deckenleuchte; Alu, weiss / Kunststoff, weiss  
plafonnier; aluminium, blanc / plastique, blanc

L 1200, B 100, H 45

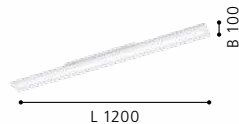
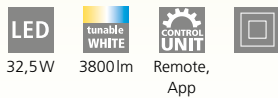

**ACCESSORIES INCLUDED**



Zubehör inkludiert  
Accessoires inclus



900049



900051



900052



### 900049 SALOBRENA-Z

ceiling light; aluminium, black / plastic, white  
Deckenleuchte; Alu, schwarz / Kunststoff, weiss  
plafonnier; aluminium, noir / plastique, blanc

L 300, B 300, H 50

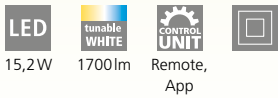

15,2W 1700lm Remote, App

### 900051 SALOBRENA-Z

ceiling light; aluminium, black / plastic, white  
Deckenleuchte; Alu, schwarz / Kunststoff, weiss  
plafonnier; aluminium, noir / plastique, blanc

L 450, B 450, H 50

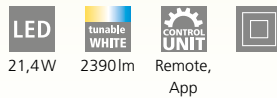

21,4W 2390lm Remote, App

### 900052 SALOBRENA-Z

ceiling light; aluminium, black / plastic, white  
Deckenleuchte; Alu, schwarz / Kunststoff, weiss  
plafonnier; aluminium, noir / plastique, blanc

L 595, B 595, H 50

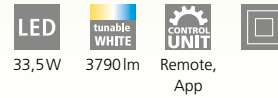

33,5W 3790lm Remote, App



9 008606 221868



9 008606 221875



9 008606 221882





900053



900095



### 900053 SALOBRENA-Z

ceiling light; aluminium, black / plastic, white  
Deckenleuchte; Alu, schwarz / Kunststoff, weiss  
plafonnier; aluminium, noir / plastique, blanc

L 1200, B 300, H 50

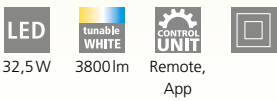

### 900095 SALOBRENA-Z

ceiling light; aluminium, steel, black / plastic, white  
Deckenleuchte; Alu, Stahl, schwarz / Kunststoff, weiss  
plafonnier; aluminium, acier, noir / plastique, blanc

L 1200, B 100, H 45

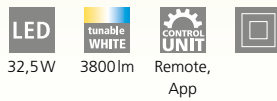

9 008606 221899



9 008606 225552

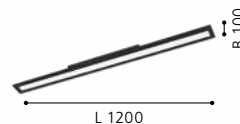



900099



IP20/44

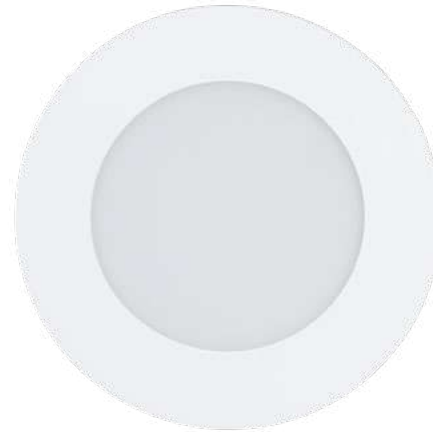

900101



IP20/44

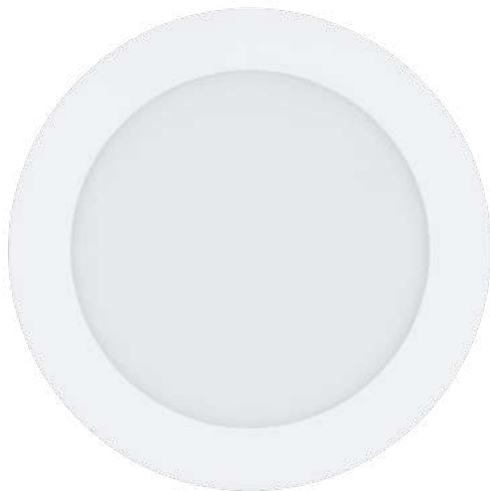

900102



IP20/44

### 900099 FUEVA-Z

recessed light; steel, white / plastic, white  
Einbauleuchte; Stahl, weiss / Kunststoff, weiss  
luminaire encastrable; acier, blanc / plastique, blanc

H 26, Ø 85



3x 2,8W



3x 360lm



Remote, App



Ø 75



IP20, IP44



9 008606 225569



Ø 85

H 26, Ø 120



5,4W



600lm



Remote, App



Ø 105



IP20, IP44



9 008606 225576



Ø 120

H 26, Ø 165



10,8W



1250lm



Remote, App



Ø 155



IP20, IP44



9 008606 225583

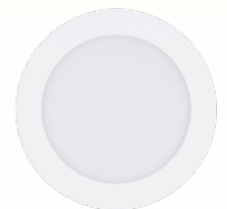

Ø 165



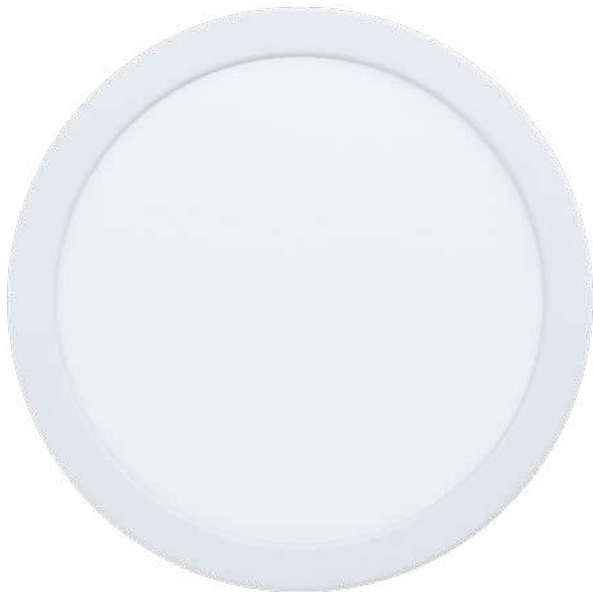

98842

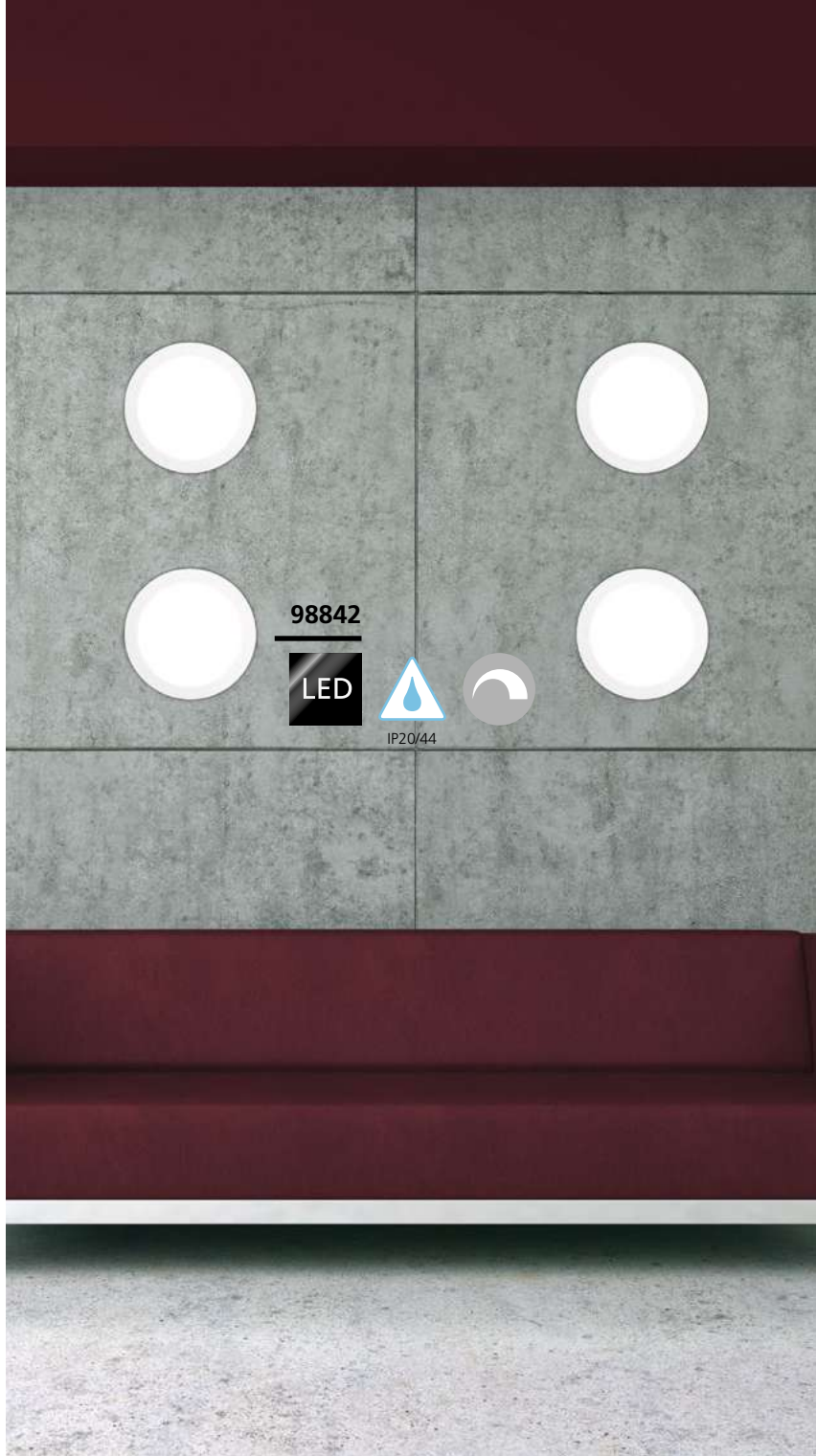

98842

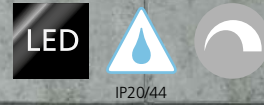

### 98842 FUEVA-Z

recessed light; aluminium, white / plastic, white  
 Einbauleuchte; Alu, weiss / Kunststoff, weiss  
 luminaire encastrable; aluminium, blanc / plastique, blanc

Ø 216, ET 26

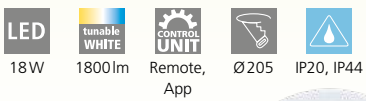



900111



900112



900113



### 900111 FUEVA-Z

recessed light; steel, satin nickel / plastic, white  
Einbauleuchte; Stahl, nickel-matt / Kunststoff, weiss  
luminaire encastrable; acier, nickel mat / plastique, blanc

H 26, Ø 85



3x 2,8W 3x 360lm



Remote, App



Ø 75



IP20, IP44



9 008606 225668



Ø 85



9 008606 225675



### 900112 FUEVA-Z

recessed light; steel, satin nickel / plastic, white  
Einbauleuchte; Stahl, nickel-matt / Kunststoff, weiss  
luminaire encastrable; acier, nickel mat / plastique, blanc

H 26, Ø 120



5,4W 600lm



Remote, App



Ø 105



IP20, IP44



Ø 120

### 900113 FUEVA-Z

recessed light; steel, satin nickel / plastic, white  
Einbauleuchte; Stahl, nickel-matt / Kunststoff, weiss  
luminaire encastrable; acier, nickel mat / plastique, blanc

H 26, Ø 165



10,8W 1250lm



Remote, App



Ø 155



IP20, IP44



9 008606 225682



Ø 165



98844



IP20/44



98844



IP20/44



### 98844 FUEVA-Z

recessed light; aluminium, satin nickel / plastic, white  
 Einbauleuchte; Alu, nickel-matt / Kunststoff, weiss  
 luminaire encastrable; aluminium, nickel mat / plastique, blanc

Ø 216, ET 26



18W



1800lm



Remote, App



Ø 205



IP20, IP44



Ø 216

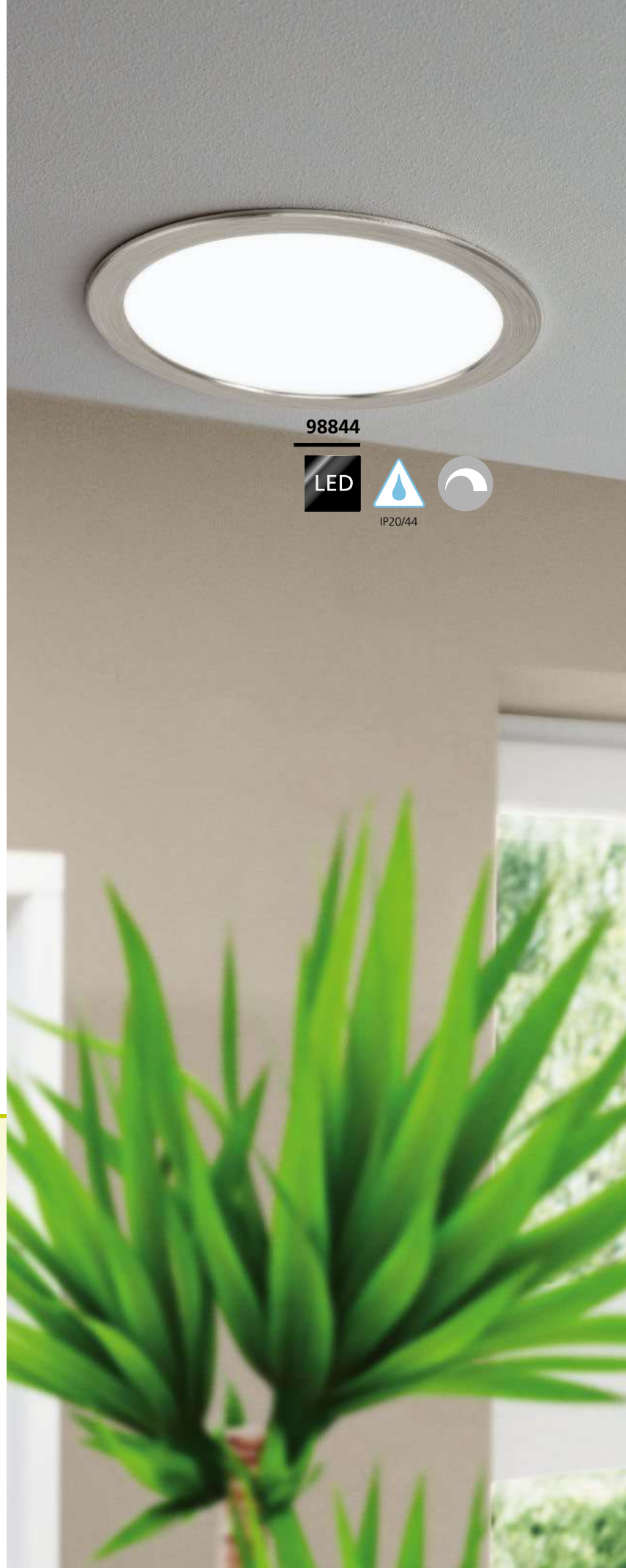



900105



IP20/44



900106



IP20/44



900107



IP20/44

### 900105 FUEVA-Z

recessed light; steel, black / plastic, white  
Einbauleuchte; Stahl, schwarz / Kunststoff, weiss  
luminaire encastrable; acier, noir / plastique, blanc

H 26, Ø 85

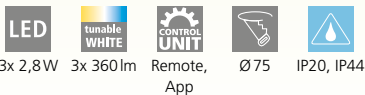

### 900106 FUEVA-Z

recessed light; steel, black / plastic, white  
Einbauleuchte; Stahl, schwarz / Kunststoff, weiss  
luminaire encastrable; acier, noir / plastique, blanc

H 26, Ø 120



### 900107 FUEVA-Z

recessed light; steel, black / plastic, white  
Einbauleuchte; Stahl, schwarz / Kunststoff, weiss  
luminaire encastrable; acier, noir / plastique, blanc

H 26, Ø 166

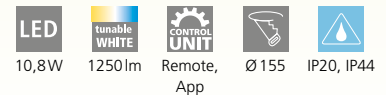

Ø 166





98846



IP20/44



### 98846 FUEVA-Z

recessed light; aluminium, black / plastic, white  
 Einbauleuchte; Alu, schwarz / Kunststoff, weiss  
 luminaire encastrable; aluminium, noir / plastique, blanc

Ø 216, ET 26



18W



1800lm



Remote,  
App



Ø205



IP20, IP44



Ø 216



RECESSED

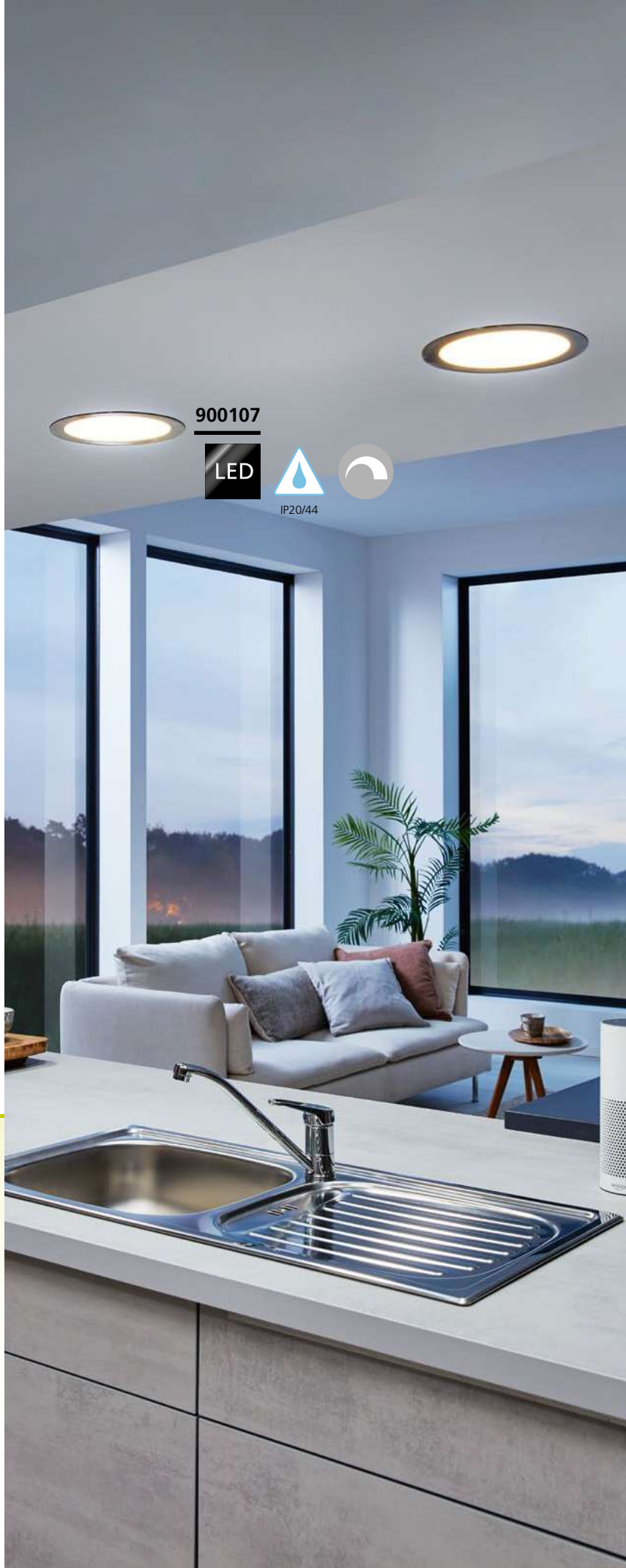

900107



IP20/44





900104



IP44



900103



IP44



98849



IP44

### 900104 FUEVA-Z

surface-mounted light; steel, white / plastic, white  
 Aufbauleuchte; Stahl, weiss / Kunststoff, weiss  
 luminaire en saillie; acier, blanc / plastique, blanc

L 210, B 210, H 28

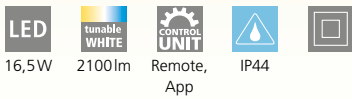

### 98849 FUEVA-Z

surface-mounted light; aluminium, white / plastic, white  
 Aufbauleuchte; Alu, weiss / Kunststoff, weiss  
 luminaire en saillie; aluminium, blanc / plastique, blanc

L 285, B 285, H 28

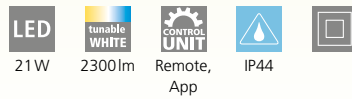

### 900103 FUEVA-Z

surface-mounted light; steel, white / plastic, white  
 Aufbauleuchte; Stahl, weiss / Kunststoff, weiss  
 luminaire en saillie; acier, blanc / plastique, blanc

H 28, Ø 210

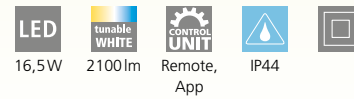

9 008606 225606



L 210



9 002759 988494



L 285



9 008606 225590



Ø 210



98843



98843



### 98843 FUEVA-Z

surface-mounted light; aluminium, white / plastic, white  
 Aufbauleuchte; Alu, weiss / Kunststoff, weiss  
 luminaire en saillie; aluminium, blanc / plastique, blanc

H 28, Ø 285

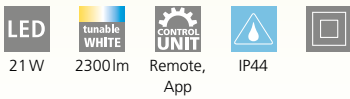



900114



900115



98845



### 900114 FUEVA-Z

surface-mounted light; steel, satin nickel / plastic, white  
Aufbauleuchte; Stahl, nickel-matt / Kunststoff, weiss  
luminaire en saillie; acier, nickel mat / plastique, blanc

### 98845 FUEVA-Z

surface-mounted light; aluminium, satin nickel / plastic, white  
Aufbauleuchte; Alu, nickel-matt / Kunststoff, weiss  
luminaire en saillie; aluminium, nickel mat / plastique, blanc

### 900115 FUEVA-Z

surface-mounted light; steel, satin nickel / plastic, white  
Aufbauleuchte; Stahl, nickel-matt / Kunststoff, weiss  
luminaire en saillie; acier, nickel mat / plastique, blanc

H 28, Ø 210



16,5W



2100lm



Remote,  
App



IP44



H 28, Ø 285



21W



2300lm



Remote,  
App



IP44



L 210, B 210, H 28



16,5W



2100lm



Remote,  
App



IP44



9 008606 225699



Ø 210



9 002759 988456



Ø 285



9 008606 225705



L 210







98852



IP44



98852



IP44

### 98852 FUEVA-Z

surface-mounted light; aluminium, satin nickel / plastic, white  
Aufbauleuchte; Alu, nickel-matt / Kunststoff, weiss  
luminaire en saillie; aluminium, nickel mat / plastique, blanc

L 285, B 285, H 28



21 W



2300 lm



Remote, App



IP44



9 002759 988524





900108



98854



98847



### 900108 FUEVA-Z

surface-mounted light; steel, black / plastic, white  
Aufbauleuchte; Stahl, schwarz / Kunststoff, weiss  
luminaire en saillie; acier, noir / plastique, blanc

H 28, Ø 210

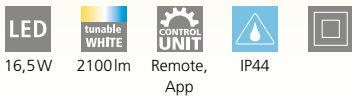

### 98847 FUEVA-Z

surface-mounted light; aluminium, black / plastic, white  
Aufbauleuchte; Alu, schwarz / Kunststoff, weiss  
luminaire en saillie; aluminium, noir / plastique, blanc

H 28, Ø 285

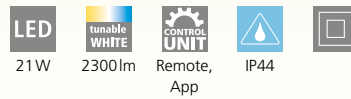

### 98854 FUEVA-Z

surface-mounted light; aluminium, black / plastic, white  
Aufbauleuchte; Alu, schwarz / Kunststoff, weiss  
luminaire en saillie; aluminium, noir / plastique, blanc

L 285, B 285, H 28

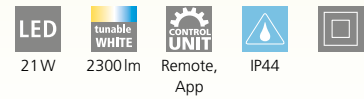

9 008606 225644



Ø 210



9 002759 988470



Ø 285



9 002759 988548



L 285





900109



IP44



900109



IP44

### 900109 FUEVA-Z

surface-mounted light; steel, black / plastic, white  
Aufbauleuchte; Stahl, schwarz / Kunststoff, weiss  
luminaire en saillie; acier, noir / plastique, blanc

L 210, B 210, H 28



16,5W



2100lm



Remote,  
App



IP44



9 008606 225651

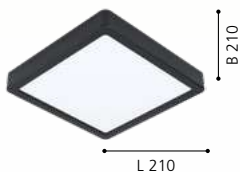



900088



900086



900089

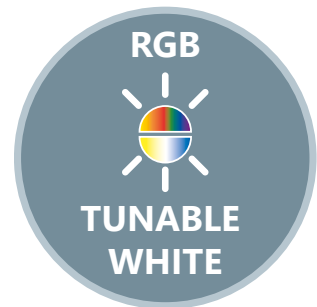

### 900088 ROVITO-Z

ceiling light; plastic, white / plastic, white  
Deckenleuchte; Kunststoff, weiss / Kunststoff, weiss  
plafonnier; plastique, blanc / plastique, blanc

L 295, B 295, H 25

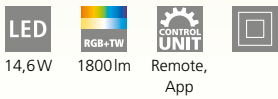

14,6W 1800lm Remote, App



9 008606 225491



L 295

### 900089 ROVITO-Z

ceiling light; plastic, white / plastic, white  
Deckenleuchte; Kunststoff, weiss / Kunststoff, weiss  
plafonnier; plastique, blanc / plastique, blanc

L 420, B 420, H 25

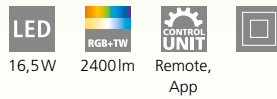

16,5W 2400lm Remote, App



9 008606 225507



L 420

### 900086 ROVITO-Z

ceiling light; plastic, white / plastic, white  
Deckenleuchte; Kunststoff, weiss / Kunststoff, weiss  
plafonnier; plastique, blanc / plastique, blanc

H 25, Ø 295



14,6W 1800lm Remote, App



9 008606 225477



Ø 295

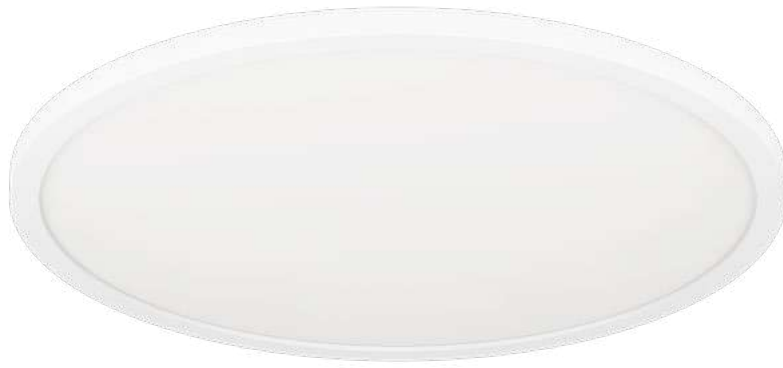

900087



900087



### 900087 ROVITO-Z

ceiling light; plastic, white / plastic, white  
Deckenleuchte; Kunststoff, weiss / Kunststoff, weiss  
plafonnier; plastique, blanc / plastique, blanc

H 25, Ø 420



16,5 W



2400 lm



Remote,  
App



9 008606 225484



Ø 420





900093



900091



900094

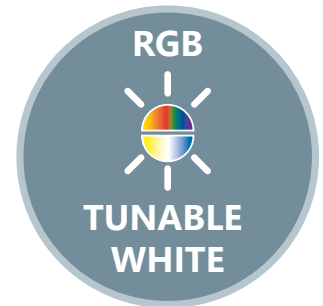

### 900093 ROVITO-Z

ceiling light; plastic, black / plastic, white  
Deckenleuchte; Kunststoff, schwarz / Kunststoff, weiss  
plafonnier; plastique, noir / plastique, blanc

L 295, B 295, H 25

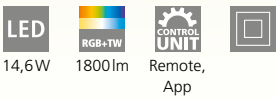

14,6W 1800lm Remote, App



9 008606 225538



### 900094 ROVITO-Z

ceiling light; plastic, black / plastic, white  
Deckenleuchte; Kunststoff, schwarz / Kunststoff, weiss  
plafonnier; plastique, noir / plastique, blanc

L 420, B 420, H 25

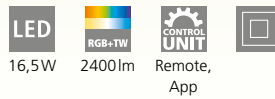

16,5W 2400lm Remote, App



9 008606 225545



### 900091 ROVITO-Z

ceiling light; plastic, black / plastic, white  
Deckenleuchte; Kunststoff, schwarz / Kunststoff, weiss  
plafonnier; plastique, noir / plastique, blanc

H 25, Ø 295

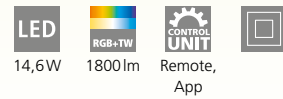

14,6W 1800lm Remote, App



9 008606 225514





900092



900091



### 900092 ROVITO-Z

ceiling light; plastic, black / plastic, white  
Deckenleuchte; Kunststoff, schwarz / Kunststoff, weiss  
plafonnier; plastique, noir / plastique, blanc

H 25, Ø 420



16,5 W



2400 lm



Remote,  
App



9 008606 225521



Ø 420



99686

99687



99684

99685



99686, 99687



1x 1,5 m

**99686 LED STRIPE-Z**

bar / strip light; plastic, white  
 Leuchtband/-stab; Kunststoff, weiss  
 bande lumineuse / bâton l; plastique, blanc

L 5000, B 10

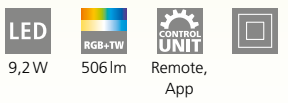

**99687 LED STRIPE-Z**

bar / strip light; plastic, white  
 Leuchtband/-stab; Kunststoff, weiss  
 bande lumineuse / bâton l; plastique, blanc

L 8000, B 12, H 3

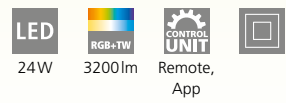

**99684 LED STRIPE-Z**

bar / strip light; plastic, white  
 Leuchtband/-stab; Kunststoff, weiss  
 bande lumineuse / bâton l; plastique, blanc

L 3000, B 8



L 5000



L 8000



L 3000



99687



### 99685 LED STRIPE-Z

bar / strip light; plastic, white  
 Leuchtband/-stab; Kunststoff, weiss  
 bande lumineuse / bâton l; plastique, blanc

L 2000, B 8



9W



900lm



Remote,  
App



9 002759 996857



L 2000



# EGLO Access

Let **light** follow  
your **life**





# OVERVIEW



ACCESS REMOTE  
p. 52



SARSINA-A  
p. 52



SARSINA-A  
p. 52



SARSINA-A  
p. 53



SALOBRENA-A  
p. 54



SALOBRENA-A  
p. 54



SALOBRENA-A  
p. 54



SALOBRENA-A  
p. 55



SALOBRENA-A  
p. 55



FUEVA-A  
p. 57



FUEVA-A  
p. 57



FUEVA-A  
p. 57



LED-STRIPE-A  
p. 58



LED-STRIPE-A  
p. 58



# LET LIGHT FOLLOW YOUR LIFE

DAS LICHT, DAS SICH IHREM LEBEN ANPASST  
LA LUMIÈRE QUE S'ADAPTE À VOTRE VIE



Light influences our lives and our work. For example, bright neutral white light improves focus, while warm, dimmed light makes us feel comfortable. You can adjust your EGLO Access luminaires to your requirements or mood.

- › One remote control for different light scenarios
- › 4-predefined settings
- › Tunable white: individually adjustable from warm white to cold white
- › Dimmable with incl. remote control
- › 2 memory functions for individual light

## THE SYSTEM'S ADVANTAGES ARE:



Quick and simple installation



One remote control for up to 8 different items and a control distance up to 10 meters.



Light colour from 2700K to 6500K



No internet access necessary

Licht beeinflusst unser Leben und unsere Tätigkeiten. Zum Beispiel fördert helles, neutralweißes Licht die Konzentration, wohingegen warmes, gedimmtes Licht uns ein Gefühl von Behaglichkeit gibt. Je nach Anforderung oder Stimmung können Sie Ihre EGLO Access Leuchte individuell einstellen.

- › Eine Fernbedienung für verschiedene Lichtszenarien
- › 4 vordefinierte Einstellungen
- › Tunable white: individuell einstellbar von Warmweiß bis Kaltweiß
- › Dimmbar mit inkludierter Fernbedienung
- › 2 Speicherfunktionen für individuelles Licht

## DIE VORTEILE DES SYSTEMS SIND:

Schnelle und einfache Installation

Eine Fernbedienung für bis zu 8 verschiedene Artikel und steuerbar bis zu 10 Meter

Lichtfarbe von 2700K bis 6500K

Kein Internetzugang erforderlich

La lumière influence nos vies et nos activités. Par exemple, une lumière blanche brillante et neutre favorise la concentration, tandis qu'une lumière chaude et atténuée nous procure une sensation de confort. En fonction de vos besoins ou de votre humeur, vous pouvez régler votre éclairage EGLO Access.

- › Une seule télécommande pour différents scénarios d'éclairage
- › 4 paramètres prédéfinis à l'emploi
- › Tunable white : réglable individuellement du blanc chaud au blanc froid
- › Graduable avec télécommande incluse
- › 2 fonctions mémoire pour un éclairage individuel

## LES AVANTAGES DU SYSTÈME SONT :

Installation simple et rapide

Une seule télécommande pour jusqu'à 8 articles différents et contrôlable jusqu'à 10 mètres

Couleur de lumière de 2 700 K à 6 500 K

Aucun accès internet nécessaire

# FUNCTIONS

## FUNKTIONEN FONCTIONS

Relax with warm light and leave the hustle and bustle of everyday life behind you. Concentrate on your work or dispel fatigue, with neutral white light the energy level is replenished. EGLO Access offers these possibilities and many more. All functions and highlights at a glance:

- › It works with radio frequency technology and allows 360 degree control
- › Controllable up to a distance of 10 meters
- › Up to 8 different items can be connected
- › Easy handling thanks to 4 ready-made settings and 2 memory functions

NIGHT LIGHT  
RELAX MODE  
WORK MODE  
SWITCH OFF AFTER 30 MINUTES

Mit warmem Licht entspannen und die Hektik des Alltages hinter sich lassen. Konzentriert arbeiten oder die Müdigkeit vertreiben, mit neutralweißem Licht wird das Energielevel wieder aufgefüllt. Diese Möglichkeiten und noch viele mehr bietet Ihnen EGLO Access. Alle Funktionen und Highlights auf einem Blick:

- › Es arbeitet mit Funktechnologie und ermöglicht eine 360-Grad-Steuerung
- › Steuerbar bis zu einer Entfernung von 10 Metern
- › Bis zu 8 verschiedene Artikel können miteinander verbunden werden
- › Einfache Handhabung durch 4 vorgefertigte Einstellungen und 2 Speicherfunktionen

NACHTLICHT  
ENTSPANNUNGSMODUS  
ARBEITSMODUS  
AUSSCHALTEN NACH 30 MINUTEN

Lumière chaude pour se détendre et laisser l'agitation quotidienne derrière soi. Travailler de manière concentrée ou chasser la fatigue, avec une lumière blanche neutre, le niveau d'énergie est rétabli. EGLO Access vous offre ces possibilités et bien d'autres encore. Toutes les fonctions et les points forts en un coup d'œil :

- › Il fonctionne avec la technologie de la fréquence radio et permet un contrôle à 360 degrés
- › Contrôlable jusqu'à une distance de 10 mètres
- › Jusqu'à 8 articles différents peuvent être connectés ensemble
- › Manipulation facile grâce à 4 réglages prêts à l'emploi et 2 fonctions mémoire

VEILLEUSE  
MODE DE DÉCOMPRESSION  
MODE DE TRAVAIL  
EXTINCTION APRÈS 30 MINUTES

## COLOUR TEMPERATURES SCALE / FARBTTEMPERATUREN SKALA / ÉCHELLE DES TEMPÉRATURES DE COULEUR



# REMOTE CONTROL

FERNBEDIENUNG  
TÉLÉCOMMANDE

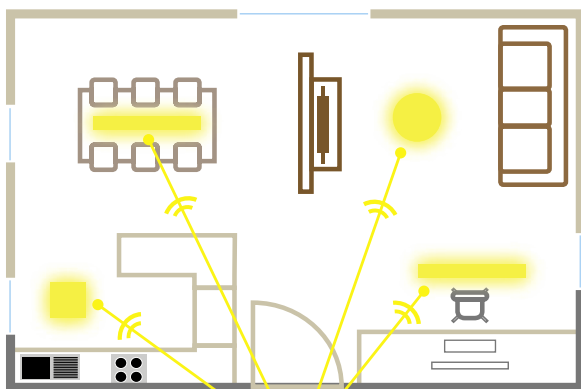

no internet necessary  
kein Internet erforderlich  
nul besoin d'internet



Control up to 8 EGLO Access luminaires  
Bis zu 8 EGLO Access Leuchten steuerbar  
Contrôle jusqu'à 8 luminaires EGLO Access





98207

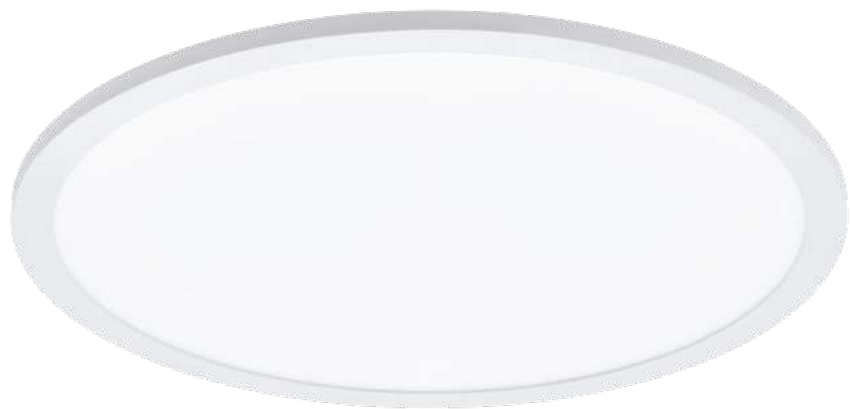

98208



33199

### 33199 ACCESS REMOTE

remote control; plastic, anthracite  
Fernbedienung; Kunststoff, anthrazit  
Télécommande; plastique, anthracite

L 118, B 45



CR2032

### 98207 SARSINA-A

ceiling light; aluminium, white / plastic, white  
Deckenleuchte; Alu, weiss / Kunststoff, weiss  
plafonnier; aluminium, blanc / plastique, blanc

H 50, Ø 300



14W



2000lm



remote



### 98208 SARSINA-A

ceiling light; aluminium, white / plastic, white  
Deckenleuchte; Alu, weiss / Kunststoff, weiss  
plafonnier; aluminium, blanc / plastique, blanc

H 50, Ø 450



19,5W



2750lm



remote



9 002759 331993



B 45

L 118



9 002759 982072



Ø 300



9 002759 982089



Ø 450



98209



98209



### 98209 SARSINA-A

ceiling light; aluminium, white / plastic, white  
Deckenleuchte; Alu, weiss / Kunststoff, weiss  
plafonnier; aluminium, blanc / plastique, blanc

H 50, Ø 600



30W



4000lm



remote



9 002759 982096



Ø 600



98201



incl./inkl./inclus

98297



incl./inkl./inclus



98203



incl./inkl./inclus

98201 SALOBRENA-A

ceiling light; aluminium, white / plastic, white  
Deckenleuchte; Alu, weiss / Kunststoff, weiss  
plafonnier; aluminium, blanc / plastique, blanc

L 300, B 300, H 50



98297 SALOBRENA-A

ceiling light; aluminium, white / plastic, white  
Deckenleuchte; Alu, weiss / Kunststoff, weiss  
plafonnier; aluminium, blanc / plastique, blanc

L 450, B 450, H 50



98203 SALOBRENA-A

ceiling light; aluminium, white / plastic, white  
Deckenleuchte; Alu, weiss / Kunststoff, weiss  
plafonnier; aluminium, blanc / plastique, blanc

L 600, B 600, H 50



9 002759 982010



L 300

B 300



9 002759 982973



L 450

B 450



9 002759 982034



L 600

B 600



98205

LED



98206

LED



### 98205 SALOBRENA-A

ceiling light; aluminium, white / plastic, white  
Deckenleuchte; Alu, weiss / Kunststoff, weiss  
plafonnier; aluminium, blanc / plastique, blanc

L 1200, B 300, H 50



### 98206 SALOBRENA-A

ceiling light; aluminium, white / plastic, white  
Deckenleuchte; Alu, weiss / Kunststoff, weiss  
plafonnier; aluminium, blanc / plastique, blanc

L 1195, B 100, H 50

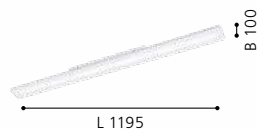
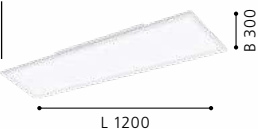



98212

LED



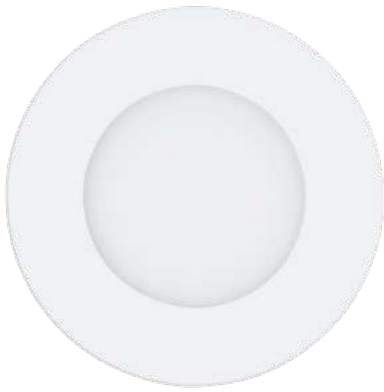

98212

LED

incl./inkl./inclus



98292

LED

incl./inkl./inclus



98293

LED

incl./inkl./inclus



### 98212 FUEVA-A

recessed light; aluminium, white / plastic, white  
Einbauleuchte; Alu, weiss / Kunststoff, weiss  
luminaire encastrable; aluminium, blanc / plastique, blanc

Ø 120, ET 30



9 002759 982126



### 98292 FUEVA-A

surface-mounted light; aluminium, white / plastic, white  
Aufbauleuchte; Alu, weiss / Kunststoff, weiss  
luminaire en saillie; aluminium, blanc / plastique, blanc

H 30, Ø 225



Ø 120



9 002759 982928



### 98293 FUEVA-A

surface-mounted light; aluminium, white / plastic, white  
Aufbauleuchte; Alu, weiss / Kunststoff, weiss  
luminaire en saillie; aluminium, blanc / plastique, blanc

H 30, Ø 300



Ø 225



9 002759 982935



Ø 300



98295



98296



98295, 98296

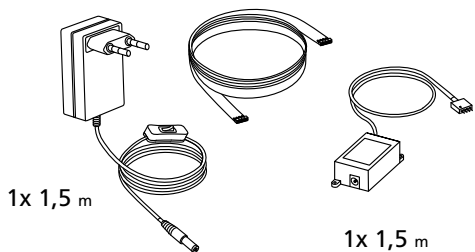

1x 1,5 m

1x 1,5 m

98295, 98296

These articles include a remote control.

Bei diesen Artikeln ist eine Fernbedienung inkludiert.

Ces articles comprennent une télécommande.



**98295 LED-STRIPE-A**

bar / strip light; plastic, white  
 Leuchtband/-stab; Kunststoff, weiss  
 bande lumineuse / bâton l; plastique, blanc

L 2000, B 10, H 3



9W

950lm

remote

**98296 LED-STRIPE-A**

bar / strip light; plastic, white  
 Leuchtband/-stab; Kunststoff, weiss  
 bande lumineuse / bâton l; plastique, blanc

L 5000, B 10, H 3



17W

1800lm

remote

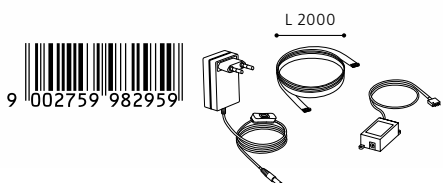

9 002759 982959

L 2000

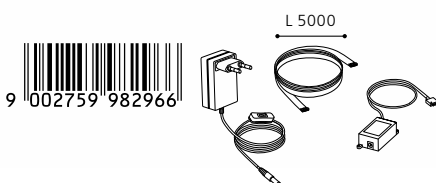

9 002759 982966

L 5000



98296





# RECESSED & SURFACE LUMINAIRES

## EMPHASIZE THE FEATURES

EMPHASIZE THE FEATURES - DISCREET IN THE APPEARANCE, PERFECTION IN STAGING. INSTEAD OF PUTTING THEMSELVES IN SCENE, THE RECESSED & SURFACE MOUNTED LUMINAIRES ARE HIGHLIGHTING YOUR LIVING AREA. THEY CONVINCED WITH THEIR UNCOMPLICATED APPLICATION AND DUE TO THE USE OF LED-PLATES AND LED-ILLUMINANTS THEY ARE POWER- AND COST-SAVING.

---

## VORTEILE

DEZENT IM AUFTRETEN, PERFEKT IN DER INSZENIERUNG. UNSERE EIN- UND AUFBAULEUCHTEN SETZEN NICHT SICH SELBST, SONDERN IHR ZUHAUSE IN SZENE. SIE ÜBERZEUGEN MIT IHRER UNKOMPLIZIERTEN ANWENDUNG UND SIND AUFGRUND DER LED-PLATINEN UND LED-LEUCHTMITTEL STROM- UND KOSTENSPAREND.

---

## AVANTAGES

DISCRET EN APPARENCE - PARFAIT DANS LA MIS EN SCÈNE. NOS LUMINAIRES ENCASTRÉES ET EN SAILLIE NE METTENT PAS EUX-MÊMES EN SCÈNE, MAIS VOTRE MAISON. ILS IMPRESSIONNENT PAR LEUR APPLICATION SIMPLE. EN PLUS, ILS RÉDUISENT LES COÛTS ET LE BESOIN D'ÉNERGIE GRÂCE AUX PLATINES ET LAMPES À LED.





# LED PANEL FUNCTION

Item Number Artikelnummer Numéro d'article	Series name Seriennamen Nom de la série	Dimensions Größe Dimensions	Page Seite Page	warm white warmweiß blanc chaud	neutral white neutralweiß blanc neutre	dimmmable dimmmbar gradable
99841	LAZARAS	Ø 450	67	•	•	•
99842	LAZARAS	L 450, B 450	67	•	•	•
32811	SALOBRENA 1	L 1200, B 300, H 50	89		•	
32812	SALOBRENA 1	L 300, B 300, H 50	88		•	
32813	SALOBRENA 1	L 595, B 595, H 50	89		•	
96151	SALOBRENA 1	L 1200, B 300, H 11	71		•	
96152	SALOBRENA 1	L 300, B 300, H 11	70		•	
96153	SALOBRENA 1	L 595, B 595, H 11	70		•	
96154	SALOBRENA 1	L 620, B 620, H 11	70		•	
98025	SALOBRENA 1	L 1195, B 100, H 45	89		•	
98129	SALOBRENA 1	L 450, B 450, H 50	88		•	
98418	SALOBRENA-M	L 595, B 595, H 50	90		•	
98419	SALOBRENA-M	L 1195, B 295, H 50	90		•	
33107	SALOBRENA-RGBW	L 450, B 450, H 11	96	•	•	•
33108	SALOBRENA-RGBW	L 600, B 300, H 11	96	•	•	•
97501	SARSINA	H 50, Ø 300	94		•	•
97502	SARSINA	H 50, Ø 450	94		•	•
97503	SARSINA	H 50, Ø 600	94		•	•
98485	SARSINA	H 50, Ø 800	95		•	•
99038	SAVATARILA	L 450, B 450, H 60	66		•	
99039	SAVATARILA	L 595, B 595, H 60	66		•	
98475	TURCONA	L 300, B 300, H 60	78	•		
98476	TURCONA	L 450, B 450, H 60	78	•		
98477	TURCONA	L 595, B 595, H 60	78	•		
98478	TURCONA	L 1200, B 300, H 60	79	•		
98479	TURCONA	L 1200, B 100, H 60	79	•		
98901	TURCONA	L 300, B 300, H 60	80		•	
98902	TURCONA	L 450, B 450, H 60	80		•	
98903	TURCONA	L 595, B 595, H 60	80		•	
98904	TURCONA	L 1200, B 300, H 60	81		•	
98905	TURCONA	L 1200, B 100, H 60	81		•	
99843	TURCONA-B	L 287, B 287, H 62	82	•		
99844	TURCONA-B	L 437, B 437, H 70	83	•		
99845	TURCONA-B	L 587, B 587, H 70	83	•		
99846	TURCONA-B	L 1187, B 287, H 70	83	•		
99833	TURCONA-CCT	L 287, B 287, H 62	84	•	•	•
99834	TURCONA-CCT	L 437, B 437, H 70	85	•	•	•
99835	TURCONA-CCT	L 587, B 587, H 70	85	•	•	•
99836	TURCONA-CCT	L 1187, B 287, H 70	85	•	•	•
99728	URTEBIETA	L 595, B 595, H 38	74		•	
99729	URTEBIETA	L 1195, B 295, H 38	74		•	





# LED PANEL LUMINAIRES

## DECORATIVE

### ADVANTAGES

- > ULTRA-FLAT DESIGN
  - > HOMOGENEOUS SURFACE LIGHTING
  - > SIMPLE AND FAST INSTALLATION
  - > DECORATIVE DOMESTIC LIGHTING
  - > WALL AND CEILING LIGHTING
- 

### VORTEILE

- > ULTRAFLACHES DESIGN
  - > HOMOGENE LICHTVERTEILUNG
  - > EINFACHE UND SCHNELLE MONTAGE
  - > DEKORATIVE WOHNBELEUCHTUNG
  - > WAND- UND DECKENBELEUCHTUNG
- 

### AVANTAGES

- > DESIGN ULTRA PLAT
- > ÉCLAIRAGE DE SURFACE HOMOGENÈ
- > MONTAGE SIMPLE ET RAPIDE
- > ÉCLAIRAGE DOMESTIQUE DÉCORATIF
- > ÉCLAIRAGE MURAL ET PLAFONNIER

# OVERVIEW

**5** year warranty  
Jahre Garantie  
ans de garantie  
anni di garanzia  
años de garantía  
anos de garantía



SAVATARILA  
p. 66



SAVATARILA  
p. 66



LAZARAS  
p. 67



LAZARAS  
p. 67





99038



99039



### 99038 SAVATARILA

ceiling light; aluminium, black / plastic, white  
Deckenleuchte; Alu, schwarz / Kunststoff, weiss  
plafonnier; aluminium, noir / plastique, blanc

L 450, B 450, H 60



24W 2900lm

### 99039 SAVATARILA

ceiling light; aluminium, black / plastic, white  
Deckenleuchte; Alu, schwarz / Kunststoff, weiss  
plafonnier; aluminium, noir / plastique, blanc

L 595, B 595, H 60



36W 4600lm



9 002759 990381

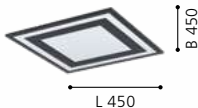

9 002759 990398

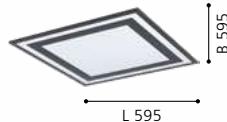





**99842**



incl./inkl./inclus  



**99841**

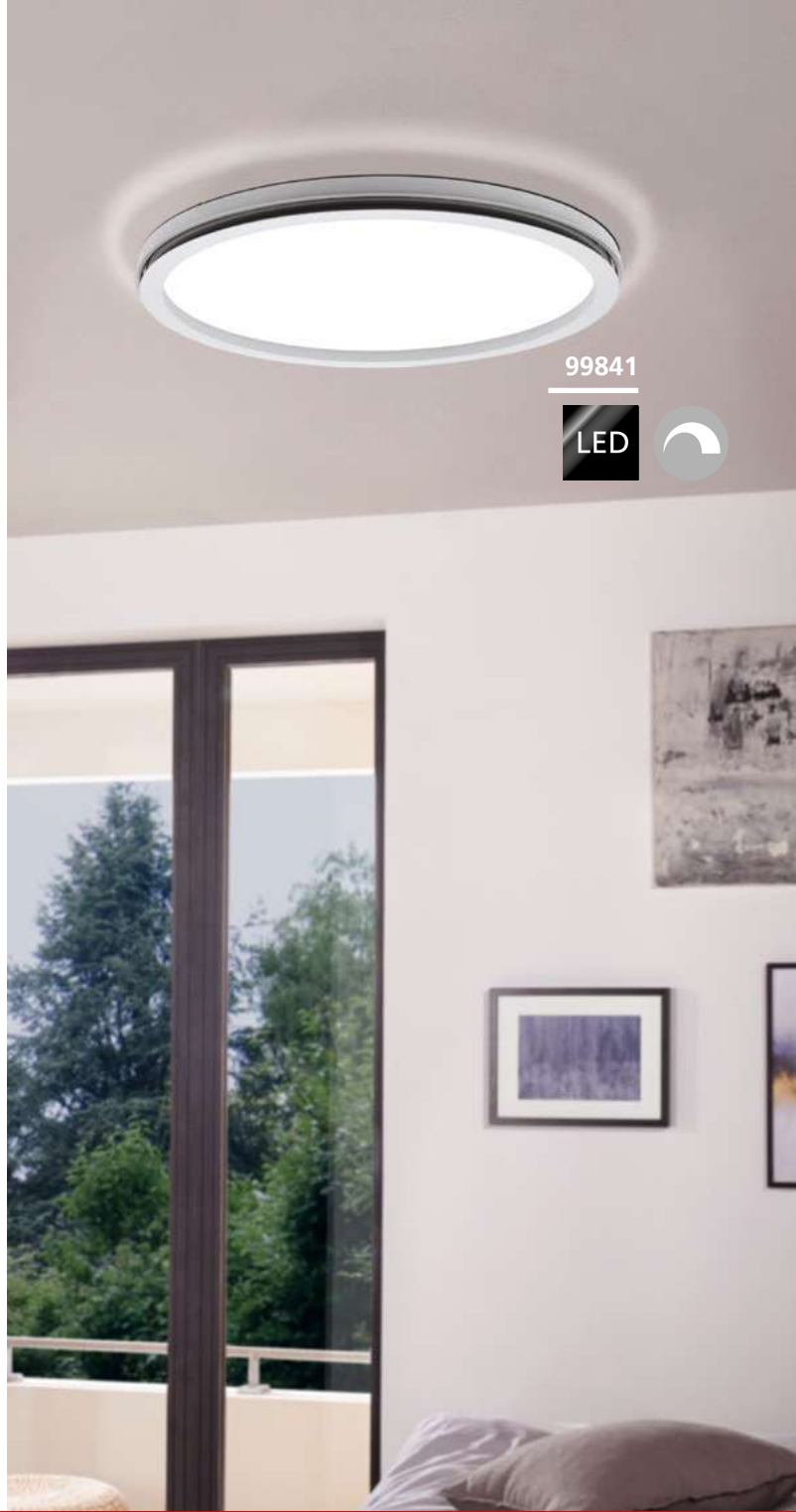

incl./inkl./inclus  

99841



**99842 LAZARAS**

ceiling light; aluminium, steel, white / plastic, white  
 Deckenleuchte; Alu, Stahl, weiss / Kunststoff, weiss  
 plafonnier; aluminium, acier, blanc / plastique, blanc

L 450, B 450



**99841 LAZARAS**

ceiling light; aluminium, steel, white / plastic, white  
 Deckenleuchte; Alu, Stahl, weiss / Kunststoff, weiss  
 plafonnier; aluminium, acier, blanc / plastique, blanc

Ø 450





# LED PANEL LUMINAIRES

## BASIC

### ADVANTAGES

- > SLIM DESIGN WITH 6 MOUNTING OPTIONS
  - > UNIFORM DISTRIBUTION OF LIGHT - IDEAL FOR ILLUMINATING SPACES AND SURFACES
  - > LOW TEMPERATURE ENHANCES SAFETY
  - > UP TO 80% POWER SAVINGS COMPARED TO INCANDESCENT LAMPS, SAVES YOUR BUDGET AND TAKES CARE OF THE ENVIRONMENT
- 

### VORTEILE

- > SCHLANKE BAUFORM MIT 6 MONTAGEVARIANTEN
  - > HOMOGENE LICHTVERTEILUNG - IDEAL ZUR BELEUCHTUNG VON RÄUMEN UND FLÄCHEN
  - > GERINGE WÄRMEENTWICKLUNG SORGT FÜR MEHR SICHERHEIT
  - > BIS ZU 80% STROMERSPARNIS GEGENÜBER GLÜHLAMPEN, SCHONT IHR BUDGET UND DIE UMWELT
- 

### AVANTAGES

- > CONCEPTION MINCE AVEC 6 OPTIONS DE MONTAGE
- > DISTRIBUTION UNIFORME DE LA LUMIÈRE - IDÉAL POUR L'ILLUMINATION DES ESPACES ET SURFACES
- > FAIBLE CHALEUR AMÉLIORE LA SÉCURITÉ
- > JUSQU'À 80% D'ÉCONOMIES D'ÉNERGIE PAR RAPPORT AUX LAMPES À INCANDESCENCE, RÉDUIT VOTRE BUDGET ET PROTÈGE L'ENVIRONNEMENT

# OVERVIEW

**5** year warranty  
Jahre Garantie  
ans de garantie  
anni di garanzia  
años de garantía  
anos de garantía



## MOUNTING MATERIAL INCLUDED

Montagezubehör inkludiert  
matériel de montage inclus

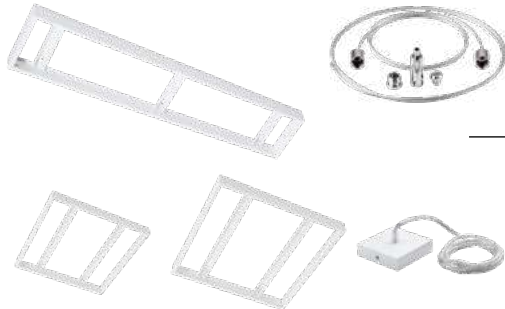

## ACCESSORIES OPTIONAL

PAGE / SEITE / PAGE **72-73**



96153



96152



96154



### 96152 SALOBRENA 1

grid light; aluminium, white / plastic, white  
Rasterleuchte; Alu, weiss / Kunststoff, weiss  
luminaire à grille; aluminium, blanc / plastique, blanc

L 300, B 300, H 11



16W 2100lm



9 002759 961527



### 96153 SALOBRENA 1

grid light; aluminium, white / plastic, white  
Rasterleuchte; Alu, weiss / Kunststoff, weiss  
luminaire à grille; aluminium, blanc / plastique, blanc

L 595, B 595, H 11



40W 4300lm



9 002759 961534



### 96154 SALOBRENA 1

grid light; aluminium, white / plastic, white  
Rasterleuchte; Alu, weiss / Kunststoff, weiss  
luminaire à grille; aluminium, blanc / plastique, blanc

L 620, B 620, H 11



40W 4100lm



9 002759 961541





96151



## MOUNTING WITH INCLUDED MATERIAL

MONTAGE MIT INKLUDIERTEM MONTAGEMATERIAL

MONTAGE AVEC MATÉRIEL DE MONTAGE INCLUS



**1 GRID LUMINAIRE  
RASTERLEUCHTE  
LUMINAIRE À GRILLE**

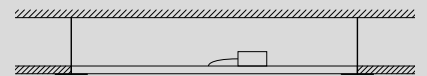

**2 RECESSED LUMINAIRE  
EINBAULEUCHTE  
LUMINAIRE ENCASTRÉE**



**3 SEMI-RECESSED LUMINAIRE  
SEMI-EINBAULEUCHTE  
LUMINAIRE SEMI-ENCASTRÉE**

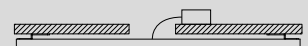

**4 SURFACE LUMINAIRE  
AUFBAULEUCHTE  
LUMINAIRE EN SAILLIE**

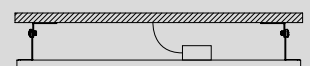

### 96151 SALOBRENA 1

grid light; aluminium, white / plastic, white  
Rasterleuchte; Alu, weiss / Kunststoff, weiss  
luminaire à grille; aluminium, blanc / plastique, blanc

L 1200, B 300, H 11

LED

40W

neutral  
WHITE

5500lm







**61489**



**61355**

**61489 SALOBRENA 1**

accessory; steel, white  
Zubehör; Stahl, weiss  
accessoire; acier, blanc

L 95, B 95, H 2000

**61355 SALOBRENA 1**

accessory; steel, chrome  
Zubehör; Stahl, chrom  
accessoire; acier, chrome

L 900

**61358 SALOBRENA 1**

accessory; steel, white  
Zubehör; Stahl, weiss  
accessoire; acier, blanc

L 603, B 603, H 50

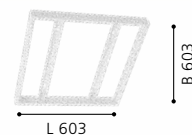
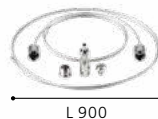

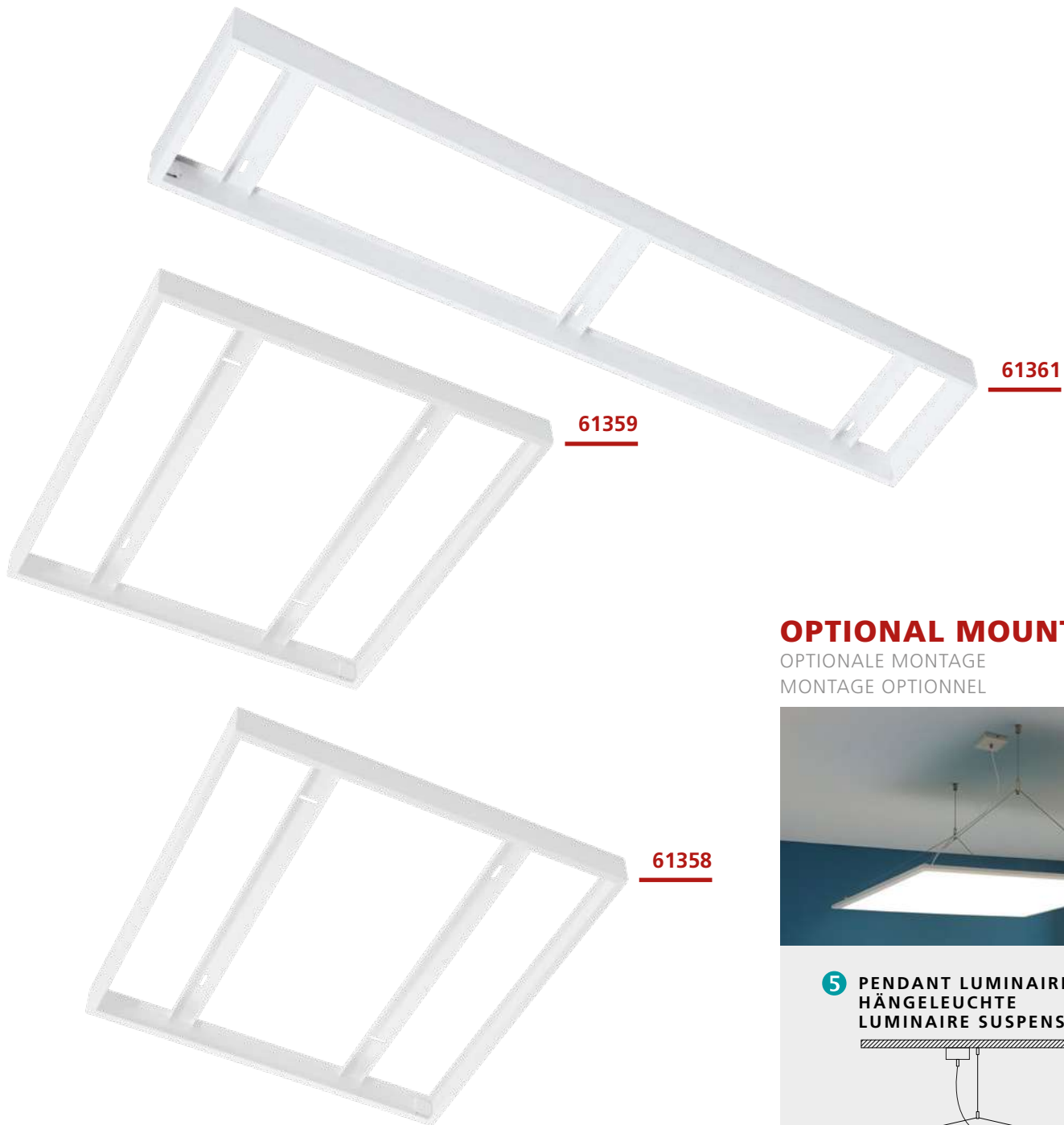

## OPTIONAL MOUNTING

OPTIONALE MONTAGE  
MONTAGE OPTIONNEL



### 5 PENDANT LUMINAIRE HÄNGELEUCHT LUMINAIRE SUSPENSION

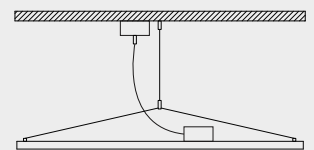

### 6 FRAME SURFACE LUMINAIRE RAHMEN AUFBAULEUCHT LUMINAIRE EN SAILLIE AVEC BOX

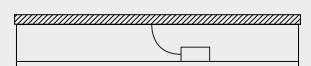

#### 61359 SALOBRENA 1

accessory; steel, white  
Zubehör; Stahl, weiss  
accessoire; acier, blanc

L 627, B 628, H 50



9 002759 613594



#### 61361 SALOBRENA 1

accessory; steel, white  
Zubehör; Stahl, weiss  
accessoire; acier, blanc

L 303, B 1205, H 50



9 002759 613617





99728



99729



99729

Due to its reduced glare effect, this luminaire is very well suited for the home office.

Diese Leuchte ist aufgrund ihres reduzierten Blendeffekts sehr gut für das Homeoffice geeignet.

En raison de son effet d'éblouissement réduit, ce luminaire est très bien adapté au bureau à domicile.

### 99728 URTEBIETA

grid light; steel, white / plastic, white  
Rasterleuchte; Stahl, weiss / Kunststoff, weiss  
luminaire à grille; acier, blanc / plastique, blanc

L 595, B 595, H 38



32W 4700lm

### 99729 URTEBIETA

grid light; steel, white / plastic, white  
Rasterleuchte; Stahl, weiss / Kunststoff, weiss  
luminaire à grille; acier, blanc / plastique, blanc

L 1195, B 295, H 38



32W 4700lm



9 002759 997281



9 002759 997298





99729

LED







# LED PANEL LUMINAIRES

## FRAMELESS

### ADVANTAGES

- > THE ENTIRE BODY OF THE PANEL IS UTILIZED AS LIGHT SOURCE
  - > ULTRA-FLAT DESIGN
  - > HOMOGENEOUS SURFACE LIGHTING
  - > SIMPLE AND FAST INSTALLATION
  - > ELEGANT SUSPENSION FRAME INCLUDED
  - > DECORATIVE DOMESTIC LIGHTING
  - > WALL AND CEILING LIGHTING
- 

### VORTEILE

- > DER GESAMTE LEUCHTKÖRPER DIENT ALS LEUCHTFLÄCHE
  - > ULTRAFLACHES DESIGN
  - > HOMOGENE LICHTVERTEILUNG
  - > EINFACHE UND SCHNELLE MONTAGE
  - > INKL. ELEGANTEM SCHWEBERAHMEN
  - > DEKORATIVE WOHNBELEUCHTUNG
  - > WAND- UND DECKENBELEUCHTUNG
- 



















### AVANTAGES

- > LE CORPS ENTIER DU PANNEAU EST UTILISÉ COMME SOURCE DE LUMIÈRE
  - > DESIGN ULTRA PLAT
  - > ÉCLAIRAGE DE SURFACE HOMOGENÈME
  - > MONTAGE SIMPLE ET RAPIDE
  - > BÂTI FLOTTANT ÉLÉGANT INCLUS
  - > ÉCLAIRAGE DOMESTIQUE DÉCORATIF
  - > ÉCLAIRAGE MURAL ET PLAFONNIER
- 



# OVERVIEW

**5** year warranty  
 Jahre Garantie  
 ans de garantie  
 anni di garanzia  
 años de garantía  
 anos de garantia

 TURCONA* p.78	 TURCONA* p.78	 TURCONA* p.78	 TURCONA* p.79	 TURCONA p.79	 TURCONA* p.80	 TURCONA* p.80	 TURCONA* p.80
 TURCONA* p.81	 TURCONA p.81	 TURCONA-B* p.82	 TURCONA-B* p.83	 TURCONA-B* p.83	 TURCONA-B* p.83	 TURCONA-CCT* p.84	 TURCONA-CCT* p.85
 TURCONA-CCT* p.85	 TURCONA-CCT* p.85						



## ACCESSORIES INCLUDED\*

Suspension frame for  
 Schweberahmen für  
 Bâti flottant pour

98475, 98901  
 white

98477, 98903  
 white

98476, 98902  
 white

98478, 98904  
 white



98475



98476



98477



## TURCONA

These luminaires have an edgelight technology.

Diese Leuchten verfügen über eine Edgelight Technology.

Ces luminaires sont équipés d'une technologie edgelight.

### 98475 TURCONA

ceiling light; steel, white / plastic, satined  
Deckenleuchte; Stahl, weiss / Kunststoff, satiniert  
plafonnier; acier, blanc / plastique, satiné

L 300, B 300, H 60



11W 1300lm



9 002759 984755



### 98476 TURCONA

ceiling light; steel, white / plastic, satined  
Deckenleuchte; Stahl, weiss / Kunststoff, satiniert  
plafonnier; acier, blanc / plastique, satiné

L 450, B 450, H 60



20W 2400lm



9 002759 984762

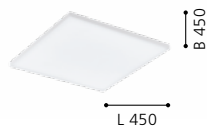

### 98477 TURCONA

ceiling light; steel, white / plastic, satined  
Deckenleuchte; Stahl, weiss / Kunststoff, satiniert  
plafonnier; acier, blanc / plastique, satiné

L 595, B 595, H 60



33W 3800lm



9 002759 984779

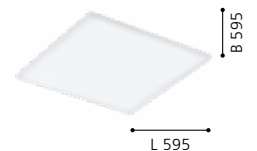



**98478**



**98479**



**98478 TURCONA**

ceiling light; steel, white / plastic, satiné  
 Deckenleuchte; Stahl, weiss / Kunststoff, satiniert  
 plafonnier; acier, blanc / plastique, satiné

L 1200, B 300, H 60



33W

3800lm

**98479 TURCONA**

ceiling light; steel, white / plastic, satiné  
 Deckenleuchte; Stahl, weiss / Kunststoff, satiniert  
 plafonnier; acier, blanc / plastique, satiné

L 1200, B 100, H 60



20W

2600lm



9 002759 984786



9 002759 984793

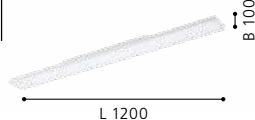



98901



98902



98903



## TURCONA

These luminaires have an edgelight technology.

Diese Leuchten verfügen über eine Edgelight Technology.

Ces luminaires sont équipés d'une technologie edgelight.

### 98901 TURCONA

ceiling light; steel, white / plastic, satined  
Deckenleuchte; Stahl, weiss / Kunststoff, satiniert  
plafonnier; acier, blanc / plastique, satiné

L 300, B 300, H 60



11W 1400lm



9 002759 989019



### 98902 TURCONA

ceiling light; steel, white / plastic, satined  
Deckenleuchte; Stahl, weiss / Kunststoff, satiniert  
plafonnier; acier, blanc / plastique, satiné

L 450, B 450, H 60



20W 2600lm



9 002759 989026

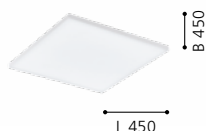

### 98903 TURCONA

ceiling light; steel, white / plastic, satined  
Deckenleuchte; Stahl, weiss / Kunststoff, satiniert  
plafonnier; acier, blanc / plastique, satiné

L 595, B 595, H 60



33W 4200lm



9 002759 989033

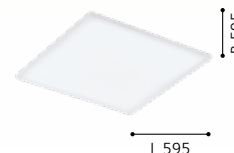



**98904**



**98905**



### 98904 TURCONA

ceiling light; steel, white / plastic, satined  
Deckenleuchte; Stahl, weiss / Kunststoff, satiniert  
plafonnier; acier, blanc / plastique, satiné

L 1200, B 300, H 60



33W 4200lm

### 98905 TURCONA

ceiling light; steel, white / plastic, satined  
Deckenleuchte; Stahl, weiss / Kunststoff, satiniert  
plafonnier; acier, blanc / plastique, satiné

L 1200, B 100, H 60



20W 2900lm



9 002759 989040

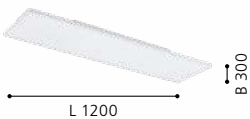

9 002759 989057

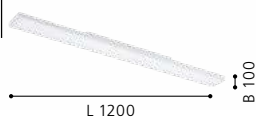



99843

LED



99843

LED

### 99843 TURCONA-B

ceiling light; aluminium, steel, white / plastic, white  
Deckenleuchte; Alu, Stahl, weiss / Kunststoff, weiss  
plafonnier; aluminium, acier, blanc / plastique, blanc

L 287, B 287, H 62

LED

12W

warm  
WHITE

1000lm



## TURCONA-B

These luminaires have a backlight technology.

Diese Leuchten verfügen über eine Backlight Technology.

Ces luminaires sont équipés d'une technologie de retour.



**99844**



**99845**



**99846**



### 99844 TURCONA-B

ceiling light; aluminium, steel, white / plastic, white  
Deckenleuchte; Alu, Stahl, weiss / Kunststoff, weiss  
plafonnier; aluminium, acier, blanc / plastique, blanc

L 437, B 437, H 70



24W 2400lm



9 002759 998448



L 437

B 437

### 99845 TURCONA-B

ceiling light; aluminium, steel, white / plastic, white  
Deckenleuchte; Alu, Stahl, weiss / Kunststoff, weiss  
plafonnier; aluminium, acier, blanc / plastique, blanc

L 587, B 587, H 70



36W 4100lm



9 002759 998455



L 587

B 587

### 99846 TURCONA-B

ceiling light; aluminium, steel, white / plastic, white  
Deckenleuchte; Alu, Stahl, weiss / Kunststoff, weiss  
plafonnier; aluminium, acier, blanc / plastique, blanc

L 1187, B 287, H 70



36W 4100lm



9 002759 998462



L 1187

B 287

## TURCONA - CCT

These luminaires have a backlight technology.

Diese Leuchten verfügen über eine Backlight Technology.

Ces luminaires sont équipés d'une technologie de retour.



**99833**



**99833**



### 99833 TURCONA-CCT

ceiling light; aluminium, steel, white / plastic, white  
Deckenleuchte; Alu, Stahl, weiss / Kunststoff, weiss  
plafonnier; aluminium, acier, blanc / plastique, blanc

L 287, B 287, H 62



12W

1200lm

remote





**99834**

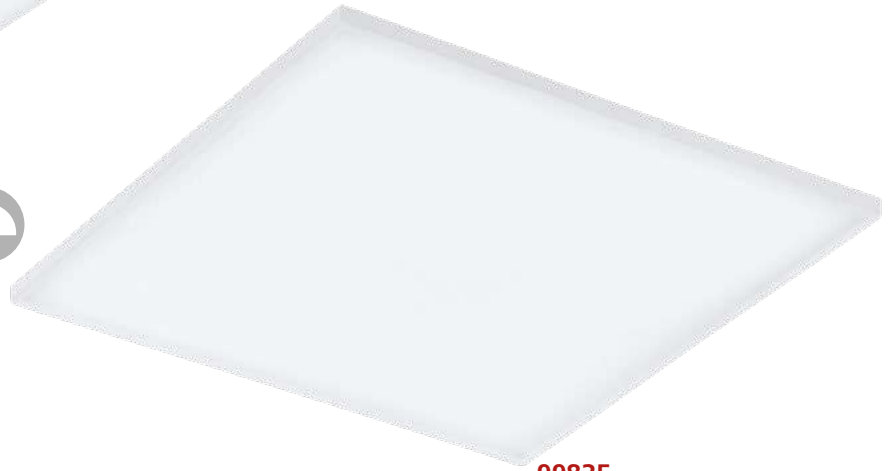

**99835**



**99836**



**99834 TURCONA-CCT**

ceiling light; aluminium, steel, white / plastic, white  
Deckenleuchte; Alu, Stahl, weiss / Kunststoff, weiss  
plafonnier; aluminium, acier, blanc / plastique, blanc

L 437, B 437, H 70



**99835 TURCONA-CCT**

ceiling light; aluminium, steel, white / plastic, white  
Deckenleuchte; Alu, Stahl, weiss / Kunststoff, weiss  
plafonnier; aluminium, acier, blanc / plastique, blanc

L 587, B 587, H 70



**99836 TURCONA-CCT**

ceiling light; aluminium, steel, white / plastic, white  
Deckenleuchte; Alu, Stahl, weiss / Kunststoff, weiss  
plafonnier; aluminium, acier, blanc / plastique, blanc

L 1187, B 287, H 70



9 002759 998349



L 437

B 437



9 002759 998356



L 587

B 587



9 002759 998363



L 1187

B 287



# LED PANEL LUMINAIRES

## WITH SUSPENSION FRAME

### ADVANTAGES

- > SURFACE LIGHT WITH SHADOWLESS LIGHTING
  - > ULTRA-FLAT DESIGN
  - > HOMOGENEOUS SURFACE LIGHTING
  - > SIMPLE INSTALLATION
  - > ELEGANT SUSPENSION FRAME INCLUDED
  - > ALSO FOR FLUSH MOUNTING SUITABLE
- 

### VORTEILE

- > FLÄCHIGES LICHT MIT SCHATTENFREIER AUSLEUCHTUNG
  - > ULTRAFLACHES DESIGN
  - > HOMOGENE FLÄCHENAUSLEUCHTUNG
  - > EINFACHE MONTAGE
  - > INKL. ELEGANTEM SCHWEBERAHMEN
  - > AUCH FÜR FLÄCHENBÜNDIGEN EINBAU GEEIGNET
- 

### AVANTAGES

- > ÉCLAIRAGE ÉTALÉ AVEC ÉCLAIREMENT
- > SANS OMBRE
- > DESIGN ULTRA PLAT
- > ÉCLAIRAGE DE SURFACE HOMOGENÈ
- > MONTAGE SIMPLE
- > BÂTI FLOTTANT ÉLÉGANT INCLUS ADAPTÉ AU MONTAGE ENCASTRÉ



# OVERVIEW

**5** year warranty  
Jahre Garantie  
ans de garantie  
anni di garanzia  
años de garantía  
anos de garantia



SALOBRENA 1•  
p. 88



SALOBRENA 1•  
p. 88



SALOBRENA 1•  
p. 89



SALOBRENA 1•  
p. 89



SALOBRENA 1  
p. 89



SALOBRENA-M•  
p. 90



SALOBRENA-M•  
p. 90



32812  
white



32813, 98418  
white



98129  
white



32811, 98419  
white

## ACCESSORIES INCLUDED

Suspension frame for luminaires  
Schweberahmen für Leuchten  
Bâti flottant pour luminaires



## MOUNTING MATERIAL INCLUDED•

Montagezubehör inkludiert  
Matériel de montage inclus



**32812**



**32812**



**98129**



**32812 SALOBRENA 1**

ceiling light; aluminium, steel, white / plastic, white  
 Deckenleuchte; Alu, Stahl, weiss / Kunststoff, weiss  
 plafonnier; aluminium, acier, blanc / plastique, blanc

L 300, B 300, H 50



16W 2100lm

**98129 SALOBRENA 1**

ceiling light; aluminium, white / plastic, white  
 Deckenleuchte; Alu, weiss / Kunststoff, weiss  
 plafonnier; aluminium, blanc / plastique, blanc

L 450, B 450, H 50



21W 2700lm



9 002759 328122



9 002759 981297





**32813**



**32811**



**98025**



### 32813 SALOBRENA 1

ceiling light; aluminium, steel, white / plastic, white  
Deckenleuchte; Alu, Stahl, weiss / Kunststoff, weiss  
plafonnier; aluminium, acier, blanc / plastique, blanc

L 595, B 595, H 50



40W 4300lm

### 32811 SALOBRENA 1

ceiling light; aluminium, steel, white / plastic, white  
Deckenleuchte; Alu, Stahl, weiss / Kunststoff, weiss  
plafonnier; aluminium, acier, blanc / plastique, blanc

L 1200, B 300, H 50



40W 5500lm

### 98025 SALOBRENA 1

ceiling light; aluminium, white / plastic, white  
Deckenleuchte; Alu, weiss / Kunststoff, weiss  
plafonnier; aluminium, blanc / plastique, blanc

L 1195, B 100, H 45



36W 4700lm



9 002759 328139



L 595



9 002759 328115



L 1200



9 002759 980252



L 1195



**98419**



12 m  
5 sec. - 15 min.



**98418**



12 m  
5 sec. - 15 min.

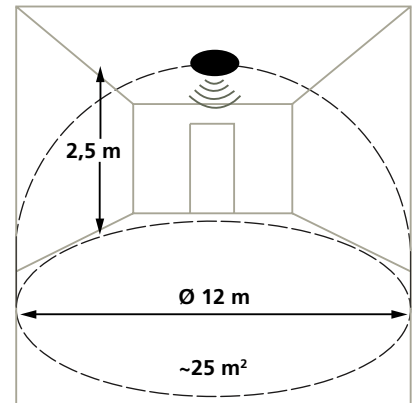

**time: 5 sec. - 15 min.**

### 98418 SALOBRENA-M

ceiling light; aluminium, white / plastic, white  
Deckenleuchte; Alu, weiss / Kunststoff, weiss  
plafonnier; aluminium, blanc / plastique, blanc

L 595, B 595, H 50



34W 4600lm



9 002759 984182



### 98419 SALOBRENA-M

ceiling light; aluminium, white / plastic, white  
Deckenleuchte; Alu, weiss / Kunststoff, weiss  
plafonnier; aluminium, blanc / plastique, blanc

L 1195, B 295, H 50



33W 5400lm



9 002759 984199



### SALOBRENA-M

These luminaires come with an integrated motion sensor. This sensor is mounted invisibly.

Diese Leuchten sind mit einem integrierten Bewegungssensor ausgestattet. Der Sensor ist unsichtbar versteckt.

Ces luminaires viennent avec un capteur de mouvement intégré. Ce capteur est attaché invisiblement.

98419



12 m  
5 sec. - 15 min.



**3**



**2**

**1**





# LED PANEL LUMINAIRES

## DIMMABLE

### ADVANTAGES

- > DIMMABLE
  - > UNIFORM DISTRIBUTION OF LIGHT - IDEAL FOR ILLUMINATING SPACES AND SURFACES
  - > LOW TEMPERATURE ENHANCES SAFETY
  - > UP TO 80% POWER SAVINGS COMPARED TO INCANDESCENT LAMPS. SAVES YOUR BUDGET AND TAKES CARE OF THE ENVIRONMENT
  - > ELEGANT SUSPENSION FRAME INCLUDED
- 

### VORTEILE

- > DIMMBAR
  - > HOMOGENE LICHTVERTEILUNG - IDEAL ZUR BELEUCHTUNG VON RÄUMEN UND FLÄCHEN
  - > GERINGE WÄRMEENTWICKLUNG SORGT FÜR MEHR SICHERHEIT
  - > BIS ZU 80% STROMERSPARNIS GEGENÜBER GLÜHLAMPEN, SCHONT IHR BUDGET UND DIE UMWELT
  - > INKL. ELEGANTEM SCHWEBERAHMEN
- 

### AVANTAGES

- > GRADUABLE
- > DISTRIBUTION UNIFORME DE LA LUMIÈRE - IDÉAL POUR L'ILLUMINATION DES ESPACES ET SURFACES
- > FAIBLE CHALEUR AMÉLIORE LA SÉCURITÉ
- > JUSQU'À 80% D'ÉCONOMIES D'ÉNERGIE PAR RAPPORT AUX LAMPES À INCANDESCENCE, RÉDUIT VOTRE BUDGET ET PROTÈGE L'ENVIRONNEMENT
- > BÂTI FLOTTANT ÉLÉGANT INCLUS

# OVERVIEW

**5** year warranty  
Jahre Garantie  
ans de garantie  
anni di garanzia  
años de garantía  
anos de garantía



SARSINA  
p. 94



SARSINA  
p. 94



SARSINA  
p. 94



SARSINA  
p. 95



SALOBRENA-  
RGBW •  
p. 96



SALOBRENA-  
RGBW •  
p. 96



97501 white



97502 white



97503 white



98485 white

## ACCESSORIES INCLUDED

Suspension frame for luminaires  
Schweberahmen für Leuchten  
Bâti flottant pour luminaires



## MOUNTING MATERIAL INCLUDED •

Montagezubehör inkludiert  
Matériel de montage inclus



97501

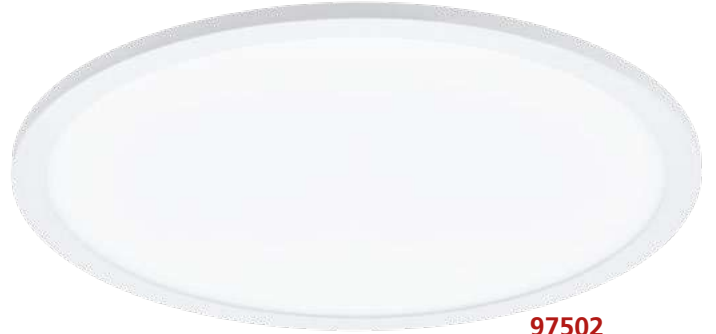

97502

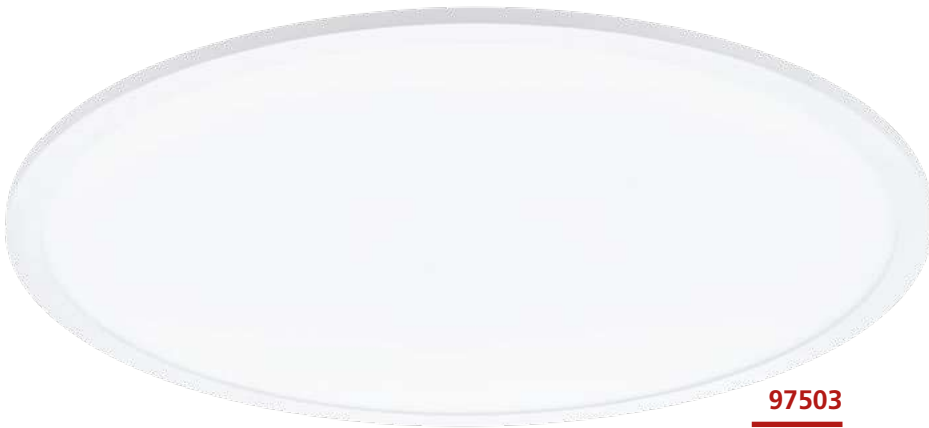

97503



### 97501 SARSINA

ceiling light; aluminium, white / plastic, white  
Deckenleuchte; Alu, weiss / Kunststoff, weiss  
plafonnier; aluminium, blanc / plastique, blanc

H 50, Ø 300



17W 2200lm

### 97502 SARSINA

ceiling light; aluminium, white / plastic, white  
Deckenleuchte; Alu, weiss / Kunststoff, weiss  
plafonnier; aluminium, blanc / plastique, blanc

H 50, Ø 450



28W 4200lm

### 97503 SARSINA

ceiling light; aluminium, white / plastic, white  
Deckenleuchte; Alu, weiss / Kunststoff, weiss  
plafonnier; aluminium, blanc / plastique, blanc

H 50, Ø 600



36W 5500lm



9 002759 975012



Ø 300



9 002759 975029



Ø 450



9 002759 975036



Ø 600



98485



98485



### 98485 SARSINA

ceiling light; aluminium, white / plastic, white  
Deckenleuchte; Alu, weiss / Kunststoff, weiss  
plafonnier; aluminium, blanc / plastique, blanc

H 50, Ø 800

LED

35W

neutral  
WHITE

5900lm



9 002759 984854



Ø 800



**33107**



**33108**



**33107 SALOBRENA-RGBW**

grid light; aluminium, white / plastic, white  
 Rasterleuchte; Alu, weiss / Kunststoff, weiss  
 luminaire à grille; aluminium, blanc / plastique, blanc

L 450, B 450, H 11



**33108 SALOBRENA-RGBW**

grid light; aluminium, white / plastic, white  
 Rasterleuchte; Alu, weiss / Kunststoff, weiss  
 luminaire à grille; aluminium, blanc / plastique, blanc

L 600, B 300, H 11



**SALOBRENA-RGBW**

With the remote control (included in delivery) the following features can be adjusted:

Durch die Fernbedienung (im Lieferumfang enthalten) verfügen diese Leuchten über folgende Funktionen:

Les fonctions différentes peuvent être réglées avec une télécommande incluse avec le luminaire:

- > Color change
- > Change to white light
- > Change to RGB
- > Flash (fast color change)
- > Smooth dimming (slow color change)  
 10%, 25%, 50%, 100%
- > on/off



9 002759 331078



9 002759 331085





33107

LED







# LED PANEL LUMINAIRES

## WOOD FRAME

### ADVANTAGES

- > DECORATIVE ELEMENT FOR THE LIVING AREA
  - > EASY ASSEMBLY
  - > EASY TO CHANGE
  - > IN 3 WOOD COLORS
  - > WOOD AS A RENEWABLE RAW MATERIAL
- 

### VORTEILE





















- > DEKORATIVES ELEMENT FÜR DEN WOHNBEREICH
  - > EINFACHE MONTAGE
  - > EINFACH WECHSELBAR
  - > IN 3 HOLZFARBEN
  - > HOLZ ALS NACHWACHSENDER ROHS TÖFF
- 

### AVANTAGES

- > ÉLÉMENT DÉCORATIF POUR LE SALON
- > MONTAGE FACILE
- > FACILE À CHANGER
- > EN 3 COULEURS DE BOIS
- > LE BOIS COMME MATIÈRE PREMIÈRE RENOUVELABLE

# OVERVIEW

**5** year warranty  
Jahre Garantie  
ans de garantie  
anni di garanzia  
años de garantía  
anos de garantía

 SALOBRENA-F p. 100	 SALOBRENA-F p. 100	 SALOBRENA-F p. 101	 SALOBRENA-F p. 101	 SALOBRENA-F p. 102	 SALOBRENA-F p. 102	 SALOBRENA-F p. 103	 SALOBRENA-F p. 103
 SALOBRENA-F p. 104	 SALOBRENA-F p. 104	 SALOBRENA-F p. 105	 SALOBRENA-F p. 105	 PIGLIONASSO p. 106	 PIGLIONASSO p. 106	 PIGLIONASSO p. 106	 PIGLIONASSO p. 107
 PIGLIONASSO p. 107	 PIGLIONASSO p. 107	 PIGLIONASSO p. 108	 PIGLIONASSO p. 108	 PIGLIONASSO p. 108			

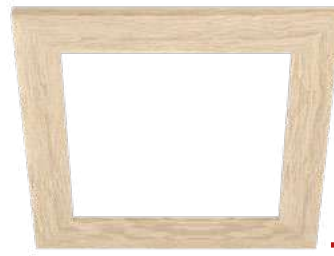

**99421**



**99422**

**99421 SALOBRENA-F**

accessory; wood, brown  
Zubehör; Holz, braun  
accessoire; bois, marron

L 340, B 340, H 16

**99422 SALOBRENA-F**

accessory; wood, brown  
Zubehör; Holz, braun  
accessoire; bois, marron

L 495, B 495, H 18



9 002759 994211



L 340

B 340



9 002759 994228



L 495

B 495

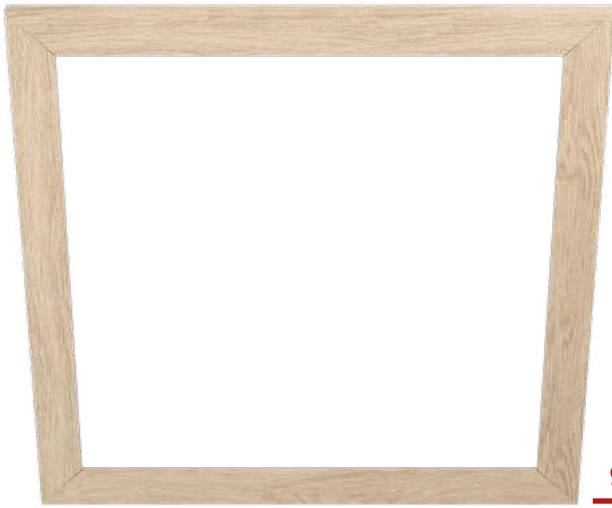

**99423**

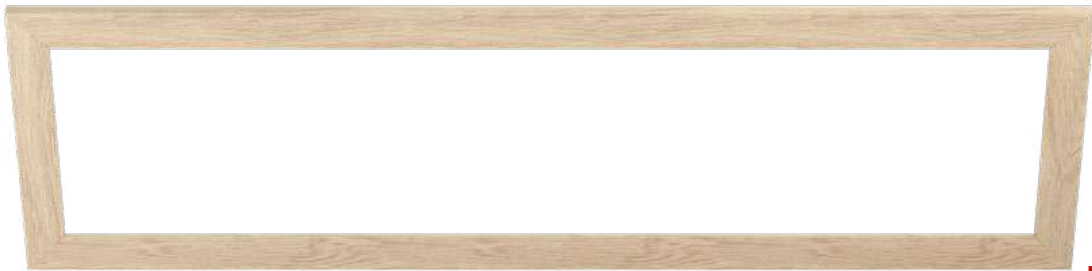

**99424**

**99423 SALOBRENA-F**

accessory; wood, brown  
Zubehör; Holz, braun  
accessoire; bois, marron

L 640, B 640, H 18

**99424 SALOBRENA-F**

accessory; wood, brown  
Zubehör; Holz, braun  
accessoire; bois, marron

L 1240, B 340, H 18



9 002759 994235

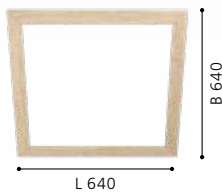

9 002759 994242

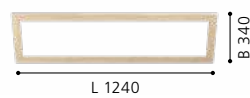



**99425**



**99426**

**99425 SALOBRENA-F**

accessory; wood, dark brown  
Zubehör; Holz, dunkelbraun  
accessoire; bois, marron foncé

L 340, B 340, H 16



9 002759 994259



L 340

**99426 SALOBRENA-F**

accessory; wood, dark brown  
Zubehör; Holz, dunkelbraun  
accessoire; bois, marron foncé

L 495, B 495, H 18



9 002759 994266



L 495

B 495



### 99427 SALOBRENA-F

accessory; wood, dark brown  
Zubehör; Holz, dunkelbraun  
accessoire; bois, marron foncé

L 640, B 640, H 18

### 99428 SALOBRENA-F

accessory; wood, dark brown  
Zubehör; Holz, dunkelbraun  
accessoire; bois, marron foncé

L 1240, B 340, H 18

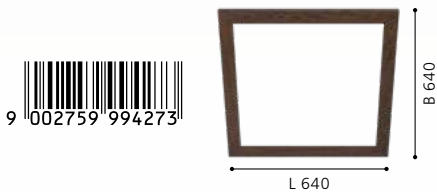





**99431**



**99432**

**99431 SALOBRENA-F**

accessory; wood, rustic  
Zubehör; Holz, rustikal  
accessoire; bois, rustique

L 340, B 340, H 16



9 002759 994310



L 340

**99432 SALOBRENA-F**

accessory; wood, rustic  
Zubehör; Holz, rustikal  
accessoire; bois, rustique

L 495, B 495, H 18



9 002759 994327



L 495

B 495

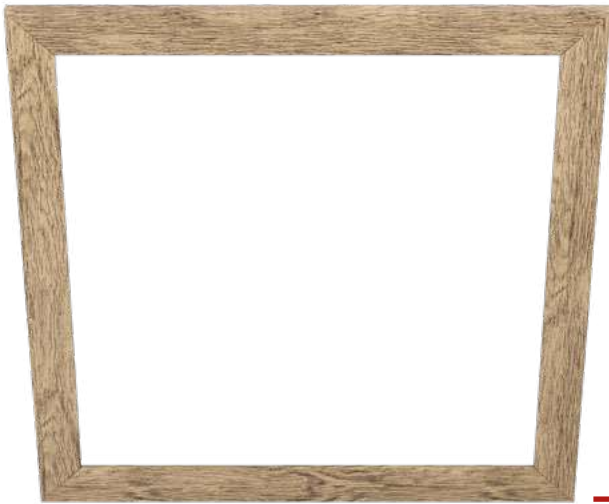

**99433**



**99434**

**99433 SALOBRENA-F**

accessory; wood, rustic  
Zubehör; Holz, rustikal  
accessoire; bois, rustique

L 640, B 640, H 18

**99434 SALOBRENA-F**

accessory; wood, rustic  
Zubehör; Holz, rustikal  
accessoire; bois, rustique

L 1240, B 340, H 18



9 002759 994334

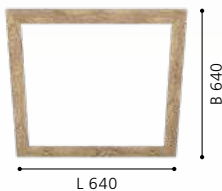

9 002759 994341





99435



99436



99437



### 99435 PIGLIONASSO

ceiling light; steel, plastic, white / wood, rustikal  
Deckenleuchte; Stahl, Kunststoff, weiss / Holz, rustikal  
plafonnier; acier, plastique, blanc / bois, rustikal

L 500, B 500, H 55



20W 2850lm



9 002759 994358

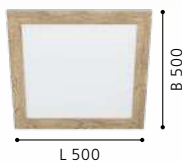

### 99436 PIGLIONASSO

ceiling light; steel, plastic, white / wood, rustikal  
Deckenleuchte; Stahl, Kunststoff, weiss / Holz, rustikal  
plafonnier; acier, plastique, blanc / bois, rustikal

L 645, B 645, H 55



32W 4700lm



9 002759 994365

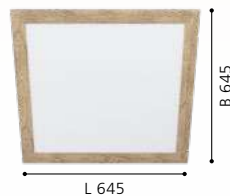

### 99437 PIGLIONASSO

ceiling light; steel, plastic, white / wood, rustikal  
Deckenleuchte; Stahl, Kunststoff, weiss / Holz, rustikal  
plafonnier; acier, plastique, blanc / bois, rustikal

L 1245, B 345, H 55



32W 4700lm



9 002759 994372



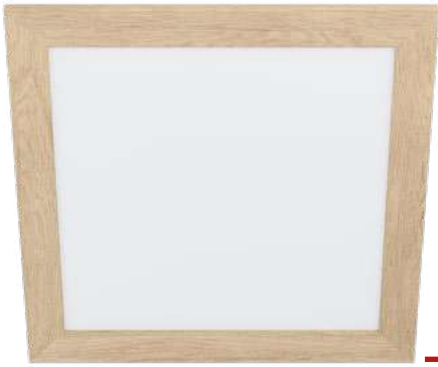

99471

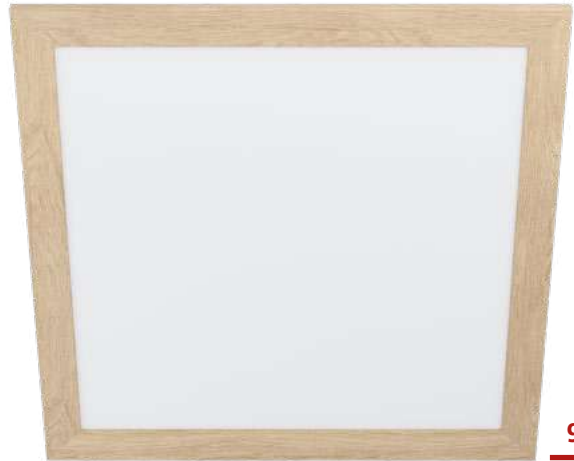

99472



99473



### 99471 PIGLIONASSO

ceiling light; steel, plastic, white / wood, brown  
Deckenleuchte; Stahl, Kunststoff, weiss / Holz, braun  
plafonnier; acier, plastique, blanc / bois, marron

L 500, B 500, H 55



20W 2850lm

### 99472 PIGLIONASSO

ceiling light; steel, plastic, white / wood, brown  
Deckenleuchte; Stahl, Kunststoff, weiss / Holz, braun  
plafonnier; acier, plastique, blanc / bois, marron

L 645, B 645, H 55



32W 4700lm

### 99473 PIGLIONASSO

ceiling light; steel, plastic, white / wood, brown  
Deckenleuchte; Stahl, Kunststoff, weiss / Holz, braun  
plafonnier; acier, plastique, blanc / bois, marron

L 1245, B 345, H 55



32W 4700lm



9 002759 994716

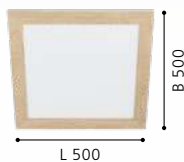

9 002759 994723

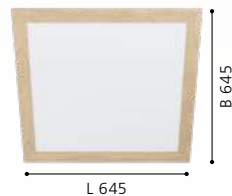

9 002759 994730





99474



99475



99476



### 99474 PIGLIONASSO

ceiling light; steel, plastic, white / wood, dark brown  
Deckenleuchte; Stahl, Kunststoff, weiss / Holz, dunkelbraun  
plafonnier; acier, plastique, blanc / bois, marron foncé

L 500, B 500, H 55



20W 2850lm



9 002759 994747

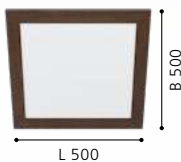

### 99475 PIGLIONASSO

ceiling light; steel, plastic, white / wood, dark brown  
Deckenleuchte; Stahl, Kunststoff, weiss / Holz, dunkelbraun  
plafonnier; acier, plastique, blanc / bois, marron foncé

L 645, B 645, H 55



32W 4700lm



9 002759 994754



### 99476 PIGLIONASSO

ceiling light; steel, plastic, white / wood, dark brown  
Deckenleuchte; Stahl, Kunststoff, weiss / Holz, dunkelbraun  
plafonnier; acier, plastique, blanc / bois, marron foncé

L 1245, B 345, H 55



32W 4700lm



9 002759 994761





99475

LED







# RECESSED LUMINAIRES

## HIGH VOLTAGE

### ADVANTAGES

- > LOW MOUNTING DEPTH
- > NO TRANSFORMER NECESSARY - THE LATEST LED HIGH-VOLTAGE TECHNOLOGY
- > IDEAL FOR LIGHTING OF ROOMS AND AREAS
- > PLEASANT WARM WHITE LIGHT COLOR
- > LOW TEMPERATURE ENHANCES SAFETY
- > UP TO 80% POWER SAVINGS COMPARED TO INCANDESCENT LAMPS, EASY ON YOUR BUDGET AND THE ENVIRONMENT
- > EASY AND SIMPLE WIRING BY 2-FOLD JUNCTION BOX - EASILY EXPANDABLE

### VORTEILE















































- > GERINGE EINBAUTIEFE
- > KEIN TRAFU MEHR NOTWENDIG - NEUESTE LED HOCHVOLT TECHNOLOGIE
- > IDEAL ZUR BELEUCHTUNG VON RÄUMEN UND FLÄCHEN
- > ANGENEHME WARM-WEISSE LICHTFARBE
- > GERINGE WÄRMEENTWICKLUNG SORGT FÜR MEHR SICHERHEIT
- > BIS ZU 80% STROMERSPARNIS GEGENÜBER GLÜHLAMPEN, SCHONT IHR BUDGET UND DIE UMWELT
- > EINFACHE UND SICHERE VERKABELUNG DURCH 2-FACH ANSCHLUSSBOX - UNKOMPLIZIERT ERWEITERBAR

### ADVANTAGES

- > FAIBLE PROFONDEUR DE MONTAGE
- > AUCUN TRANSFORMATEUR NÉCESSAIRE - LA DERNIÈRE TECHNOLOGIE À HAUTE TENSION LED
- > IDÉAL POUR L'ÉCLAIRAGE DES CHAMBRES ET DES ESPACES
- > AGRÉABLE COULEUR DE LUMIÈRE BLANCHE CHAUDE
- > FAIBLE CHALEUR AMÉLIORE LA SÉCURITÉ
- > JUSQU'À 80% D'ÉCONOMIES D'ÉNERGIE PAR RAPPORT AUX LAMPES À INCANDESCENCE, RÉDUIT VOTRE BUDGET ET PROTÈGE L'ENVIRONNEMENT
- > NOTRE BOITE DE DEUX JONCTIONS PERMET UN CÂBLAGE SIMPLE ET SECURE. EN PLUS ELLE EST FACILEMENT EXTENSIBLE.

# OVERVIEW

**5** year warranty  
 Jahre Garantie  
 ans de garantie  
 anni di garanzia  
 años de garantía  
 años de garantía

							
PINEDA p. 114	PINEDA p. 115	PINEDA p. 115	PINEDA p. 115	PINEDA p. 116	PINEDA p. 116	PINEDA p. 116	PINEDA p. 117
							
PINEDA p. 117	PINEDA p. 117	PINEDA p. 118	PINEDA p. 118	PINEDA p. 118	SARTIANO p. 120	SALICETO p. 122	SALICETO p. 122
							
SALICETO p. 122	SALICETO p. 123	SALICETO p. 124	SALICETO p. 124	SALICETO p. 124	SALICETO p. 125	SALICETO p. 126	SALICETO p. 126
							
SALICETO p. 126	SALICETO p. 127	SALICETO p. 127	SALICETO p. 128	SALICETO p. 128	SALICETO p. 128	SALICETO p. 129	SALICETO p. 129
							
SALABATE p. 130	SALABATE p. 130	SALABATE p. 130	SALABATE p. 131	SALABATE p. 131	SALABATE p. 131	PINEDA p. 132	PINEDA p. 132
							
PINEDA p. 132	PINEDA p. 133	PINEDA p. 133	PINEDA p. 133	PINEDA p. 134	PINEDA p. 134	PINEDA p. 134	PINEDA 1 p. 135
							
PINEDA 1 p. 135	ZARATE p. 136	ZARATE p. 136	MECINOS p. 137	MECINOS p. 137			



# 1 SIMPLE INSTALLATION!

Einfache Montage! / Montage simple !

Universally usable in walls or ceilings thanks to its small installation depth!

Durch die geringe Einbautiefe universell einsetzbar, ob Wand oder Decke!

Emploi universel dû à la faible profondeur de montage, que ce soit au mur ou au plafond !

# 2 QUICK AND SAFE CONNECTION!

Schnelles und sicheres Anschließen! /  
Branchement rapide et sûr !

Easy wiring with the practical connection box!  
No transformer is needed anymore thanks to  
state of-the-art high-voltage technology!

Leichtes Verkabeln durch die praktische An-  
schlussbox! Durch moderne Hochvolt-Technik  
wird kein Trafo mehr benötigt!

Câbler simplement avec le boîtier de  
branchement pratique ! Grâce à la technique de  
haute tension moderne, plus besoin de transfor-  
mateur !



# 3 PERFECT FIT!

Perfekter Halt! / Maintien parfait !

The integrated holding brackets permit simple  
installation and guarantee for a precise fit!

Die integrierten Halteklammern ermöglichen  
einen einfachen Einbau und sorgen für garantierte  
Passgenauigkeit!

Les griffes de maintien intégrées permettent un  
montage simple et assurent un parfait ajustement !





# 4

## FLUSH INSTALLATION!

FLÄCHENBÜNDIGER EINBAU! / MONTAGE À FLEUR !

The slim build permits fitting installation in any surface!

Die schlanke Bauform ermöglicht den passenden Einbau bei jeder Fläche!

La structure fine permet le montage adéquat avec chaque surface !





95848

LED



95848

LED

**95848 PINEDA**

recessed light; plastic, chrome  
 Einbauleuchte; Kunststoff, chrom  
 luminaire encastrable; plastique, chrome

Ø 84, ET 40

LED

1x 6W

warm  
WHITE

1x  
500lm



Ø72



9 002759 958480







95854



95856



95855



### 95854 PINEDA

recessed light; plastic, white  
Einbauleuchte; Kunststoff, weiss  
luminaire encastrable; plastique, blanc

Ø 84, ET 40



1x 6W  
1x 500lm  
Ø 72



9 002759 958541



Ø 84

### 95855 PINEDA

recessed light; plastic, chrome  
Einbauleuchte; Kunststoff, chrom  
luminaire encastrable; plastique, chrome

Ø 84, ET 40



1x 6W  
1x 500lm  
Ø 72



9 002759 958558



Ø 84

### 95856 PINEDA

recessed light; plastic, satin nickel  
Einbauleuchte; Kunststoff, nickel-matt  
luminaire encastrable; plastique, nickel mat

Ø 84, ET 40



1x 6W  
1x 500lm  
Ø 72



9 002759 958565



Ø 84





95851

LED



95853

LED



95852

LED

**95851 PINEDA**

recessed light; plastic, white  
 Einbauleuchte; Kunststoff, weiss  
 luminaire encastrable; plastique, blanc

**95852 PINEDA**

recessed light; plastic, chrome  
 Einbauleuchte; Kunststoff, chrom  
 luminaire encastrable; plastique, chrome

**95853 PINEDA**

recessed light; plastic, satin nickel  
 Einbauleuchte; Kunststoff, nickel-matt  
 luminaire encastrable; plastique, nickel mat

Ø 84, ET 40



Ø 84, ET 40



Ø 84, ET 40





95857

LED



95859

LED



95858

LED



### 95857 PINEDA

recessed light; plastic, white  
 Einbauleuchte; Kunststoff, weiss  
 luminaire encastrable; plastique, blanc

### 95858 PINEDA

recessed light; plastic, chrome  
 Einbauleuchte; Kunststoff, chrom  
 luminaire encastrable; plastique, chrome

### 95859 PINEDA

recessed light; plastic, satin nickel  
 Einbauleuchte; Kunststoff, nickel-matt  
 luminaire encastrable; plastique, nickel mat

Ø 84, ET 40

LED

3x 6W

warm  
WHITE

3x  
500lm



Ø 72



9 002759 958572



Ø 84

Ø 84, ET 40

LED

3x 6W

warm  
WHITE

3x  
500lm



Ø 72



9 002759 958589



Ø 84

Ø 84, ET 40

LED

3x 6W

warm  
WHITE

3x  
500lm



Ø 72



9 002759 958596



Ø 84



95843

LED



95844

LED



95846

LED



### 95843 PINEDA

recessed light; plastic, satin nickel  
Einbauleuchte; Kunststoff, nickel-matt  
luminaire encastrable; plastique, nickel mat

### 95844 PINEDA

recessed light; plastic, white  
Einbauleuchte; Kunststoff, weiss  
luminaire encastrable; plastique, blanc

### 95846 PINEDA

recessed light; plastic, satin nickel  
Einbauleuchte; Kunststoff, nickel-matt  
luminaire encastrable; plastique, nickel mat

L 84, B 84, ET 40



1x 6W  
1x 500lm



L 84, B 84, ET 40



3x 6W  
3x 500lm



L 84, B 84, ET 40



3x 6W  
3x 500lm



9 002759 958435



9 002759 958442



9 002759 958466





95844

LED



32896

LED

### 32896 SARTIANO

recessed light; plastic, white

Einbauleuchte; Kunststoff, weiss

luminaire encastrable; plastique, blanc

Ø 90, ET 45

LED

3x 5W

warm  
WHITE

3x  
470lm



Ø73



9 002759 328962







32896

LED





98243



98244



98607



### 98243 SALICETO

recessed light; aluminium, white  
Einbauleuchte; Alu, weiss  
luminaire encastrable; aluminium, blanc

H 42, Ø 88, ET 50



### 98244 SALICETO

recessed light; aluminium, satin nickel  
Einbauleuchte; Alu, nickel-matt  
luminaire encastrable; aluminium, nickel mat

H 42, Ø 88, ET 50



### 98607 SALICETO

recessed light; aluminium, black  
Einbauleuchte; Alu, schwarz  
luminaire encastrable; aluminium, noir

H 42, Ø 88, ET 50



9 002759 982430

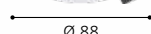

9 002759 982447

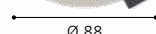

9 002759 986070

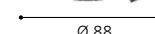



98244



98246



### 98246 SALICETO

recessed light; aluminium, satin nickel

Einbauleuchte; Alu, nickel-matt

luminaire encastrable; aluminium, nickel mat

H 42, Ø 88, ET 50

LED

6W

neutral  
WHITE

450lm



Ø68



9 002759 982461



Ø 88



**98471**



**98473**



**98472**



### 98471 SALICETO

recessed light; aluminium, white / glass, clear  
 Einbauleuchte; Alu, weiss / Glas, klar  
 luminaire encastrable; aluminium, blanc / verre, clair

### 98472 SALICETO

recessed light; aluminium, satin nickel / glass, clear  
 Einbauleuchte; Alu, nickel-matt / Glas, klar  
 luminaire encastrable; aluminium, nickel mat / verre, clair

### 98473 SALICETO

recessed light; aluminium, white / glass, clear  
 Einbauleuchte; Alu, weiss / Glas, klar  
 luminaire encastrable; aluminium, blanc / verre, clair

L 88, B 88, H 42, ET 50



L 88, B 88, H 42, ET 50



L 88, B 88, H 42, ET 50



9 002759 984717



9 002759 984724



9 002759 984731





98474

LED



98474

LED



### 98474 SALICETO

recessed light; aluminium, satin nickel / glass, clear  
Einbauleuchte; Alu, nickel-matt / Glas, klar  
luminaire encastrable; aluminium, nickel mat / verre, clair

L 88, B 88, H 42, ET 50

LED

6W

neutral  
WHITE

450lm



Ø68



9 002759 984748





**98301**



**98303**



**98609**



### 98301 SALICETO

recessed light; aluminium, white  
 Einbauleuchte; Alu, weiss  
 luminaire encastrable; aluminium, blanc

H 42, Ø 88, ET 50



### 98303 SALICETO

recessed light; aluminium, satin nickel  
 Einbauleuchte; Alu, nickel-matt  
 luminaire encastrable; aluminium, nickel mat

H 42, Ø 88, ET 50



### 98609 SALICETO

recessed light; aluminium, black  
 Einbauleuchte; Alu, schwarz  
 luminaire encastrable; aluminium, noir

H 42, Ø 88, ET 50



9 002759 983017



Ø 88



9 002759 983031



Ø 88



9 002759 986094



Ø 88







**98305**

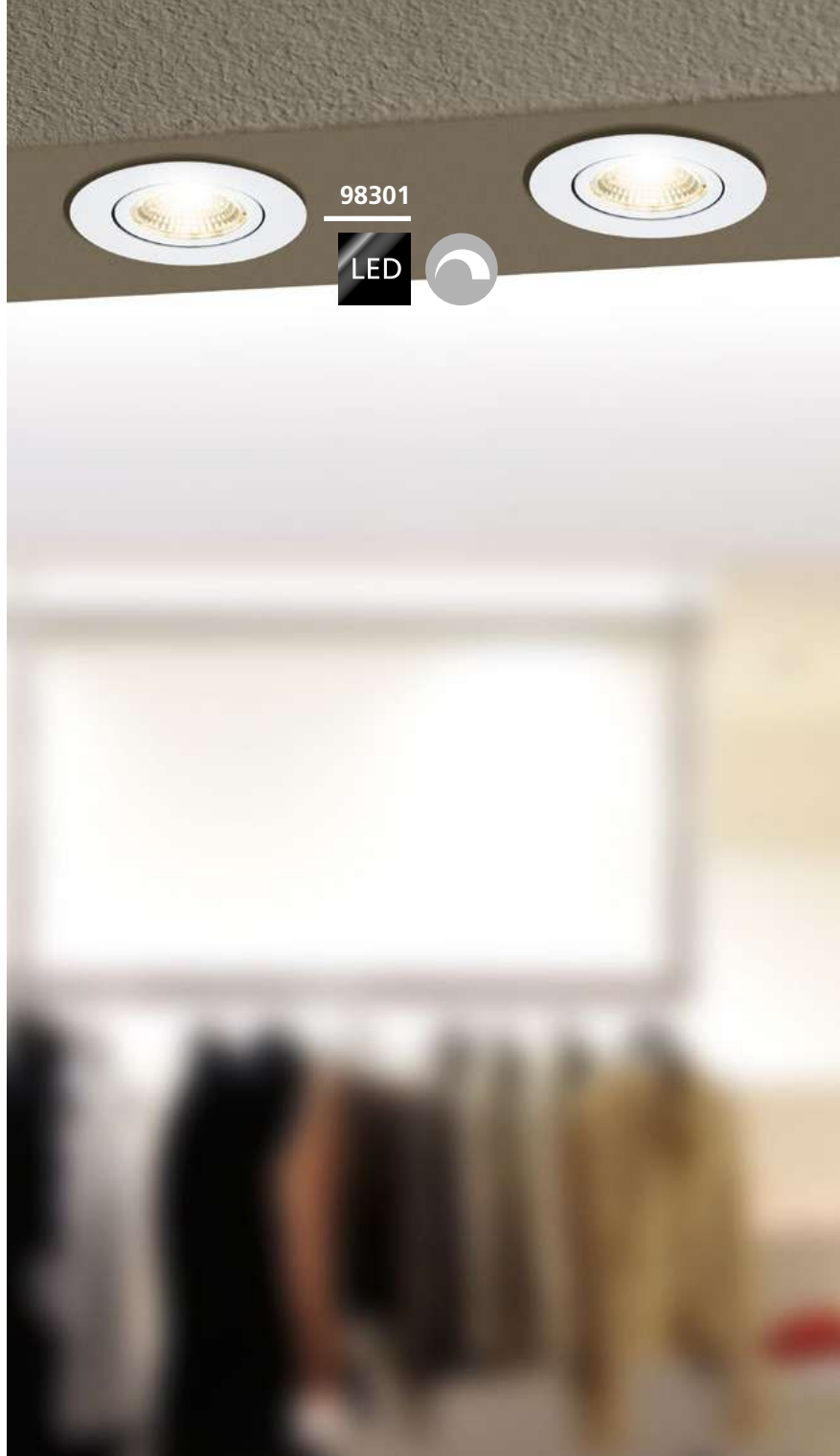

**98301**



**98307**



**98305 SALICETO**

recessed light; aluminium, white  
 Einbauleuchte; Alu, weiss  
 luminaire encastrable; aluminium, blanc

H 42, Ø 88, ET 50



**98307 SALICETO**

recessed light; aluminium, satin nickel  
 Einbauleuchte; Alu, nickel-matt  
 luminaire encastrable; aluminium, nickel mat

H 42, Ø 88, ET 50



9 002759 983055



9 002759 983079

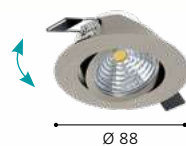





**98302**



**98304**



**98611**



**98302 SALICETO**

recessed light; aluminium, white  
 Einbauleuchte; Alu, weiss  
 luminaire encastrable; aluminium, blanc

L 88, B 88, H 42, ET 50



**98304 SALICETO**

recessed light; aluminium, satin nickel  
 Einbauleuchte; Alu, nickel-matt  
 luminaire encastrable; aluminium, nickel mat

L 88, B 88, H 42, ET 50



**98611 SALICETO**

recessed light; aluminium, black  
 Einbauleuchte; Alu, schwarz  
 luminaire encastrable; aluminium, noir

L 88, B 88, H 42, ET 50

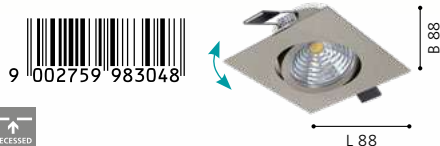



**98306**



**98308**



**98308**



### 98306 SALICETO

recessed light; aluminium, white  
 Einbauleuchte; Alu, weiss  
 luminaire encastrable; aluminium, blanc

L 88, B 88, H 42, ET 50



### 98308 SALICETO

recessed light; aluminium, satin nickel  
 Einbauleuchte; Alu, nickel-matt  
 luminaire encastrable; aluminium, nickel mat

L 88, B 88, H 42, ET 50



9 002759 983062



9 002759 983086





98238



IP20/44



99493



IP20/44



98241



IP20/44



### 98238 SALABATE

recessed light; aluminium, white / glass, clear  
Einbauleuchte; Alu, weiss / Glas, klar  
luminaire encastrable; aluminium, blanc / verre, clair

Ø 88, ET 52



### 98241 SALABATE

recessed light; aluminium, white / glass, clear  
Einbauleuchte; Alu, weiss / Glas, klar  
luminaire encastrable; aluminium, blanc / verre, clair

Ø 88, ET 52



### 99493 SALABATE

recessed light; aluminium, black / glass, clear  
Einbauleuchte; Alu, schwarz / Glas, klar  
luminaire encastrable; aluminium, noir / verre, clair

Ø 88, ET 52





**99494**



IP20/44



**98239**



IP20/44



**98242**



IP20/44

### 99494 SALABATE

recessed light; aluminium, black / glass, clear  
 Einbauleuchte; Alu, schwarz / Glas, klar  
 luminaire encastrable; aluminium, noir / verre, clair

Ø 88, ET 52



6W



450lm



Ø68



IP20, IP44



9 002759 994945



Ø 88

### 98239 SALABATE

recessed light; aluminium, white / glass, clear  
 Einbauleuchte; Alu, weiss / Glas, klar  
 luminaire encastrable; aluminium, blanc / verre, clair

L 88, B 88, ET 52



6W



380lm



Ø68



IP20, IP44



9 002759 982393



L 88

### 98242 SALABATE

recessed light; aluminium, white / glass, clear  
 Einbauleuchte; Alu, weiss / Glas, klar  
 luminaire encastrable; aluminium, blanc / verre, clair

L 88, B 88, ET 52



6W



450lm



Ø68



IP20, IP44



9 002759 982423



L 88

B 88



**95817**



IP20/44



**95819**



IP20/44



**95818**



IP20/44

**95817 PINEDA**

recessed light; plastic, white  
 Einbauleuchte; Kunststoff, weiss  
 luminaire encastrable; plastique, blanc

**95818 PINEDA**

recessed light; plastic, chrome  
 Einbauleuchte; Kunststoff, chrom  
 luminaire encastrable; plastique, chrome

**95819 PINEDA**

recessed light; plastic, satin nickel  
 Einbauleuchte; Kunststoff, nickel-matt  
 luminaire encastrable; plastique, nickel mat

Ø 78, ET 35

1x 6W  
 1x 500lm  
  
  
  
  
 Ø65



9 002759 958176



Ø 78

Ø 78, ET 35

1x 6W  
 1x 500lm  
  
  
  
  
 Ø65



9 002759 958183



Ø 78

Ø 78, ET 35

1x 6W  
 1x 500lm  
  
  
  
  
 Ø65



9 002759 958190



Ø 78



**95821**

LED



IP20/44



**95823**

LED



IP20/44

**95822**

LED



IP20/44

**95821 PINEDA**

recessed light; plastic, white  
 Einbauleuchte; Kunststoff, weiss  
 luminaire encastrable; plastique, blanc

**95822 PINEDA**

recessed light; plastic, chrome  
 Einbauleuchte; Kunststoff, chrom  
 luminaire encastrable; plastique, chrome

**95823 PINEDA**

recessed light; plastic, satin nickel  
 Einbauleuchte; Kunststoff, nickel-matt  
 luminaire encastrable; plastique, nickel mat

Ø 78, ET 35

LED 3x 6W  
 warm WHITE 3x 500lm  
  
  
 Ø 65

  
 IP44/20



Ø 78



Ø 78, ET 35

LED 3x 6W  
 warm WHITE 3x 500lm  
  
  
 Ø 65

  
 IP44/20



Ø 78



Ø 78, ET 35

LED 3x 6W  
 warm WHITE 3x 500lm  
  
  
 Ø 65

  
 IP44/20



Ø 78





95962, 95887, 95888, 95889

These luminaires are protected against splash water.

Diese Leuchten sind gegen Spritzwasser geschützt.

Les luminaires sont protégées contre les éclaboussures d'eau.



95887



IP20/44



	0	1	2	3
EU	X	X	✓	✓
FR	X	X	X	✓



95888



IP20/44



95889



IP20/44

95887 PINEDA

recessed light; plastic, white  
Einbauleuchte; Kunststoff, weiss  
luminaire encastrable; plastique, blanc

95888 PINEDA

recessed light; plastic, chrome  
Einbauleuchte; Kunststoff, chrom  
luminaire encastrable; plastique, chrome

95889 PINEDA

recessed light; plastic, satin nickel  
Einbauleuchte; Kunststoff, nickel-matt  
luminaire encastrable; plastique, nickel mat

Ø 102, ET 35



9 002759 958879



Ø 102

Ø 102, ET 35



9 002759 958886



Ø 102

Ø 102, ET 35



9 002759 958893



Ø 102



95932

LED



95962

LED



IP44



95932

LED

### 95932 PINEDA 1

recessed light; steel, plastic, white, satin nickel / plastic, clear, satined

Einbauleuchte; Stahl, Kunststoff, weiss, nickel-matt / Kunststoff, klar, satiniert

luminaire encastrable; acier, plastique, blanc, nickel mat / plastique, clair, satiné  
Ø 145, ET 35

LED

1x 12W

warm  
WHITE

1x  
1000lm



Ø 90



9 002759 959326



Ø 145



### 95962 PINEDA 1

recessed light; steel, plastic, chrome / plastic, white

Einbauleuchte; Stahl, Kunststoff, chrom / Kunststoff, weiss

luminaire encastrable; acier, plastique, chrome / plastique, blanc

Ø 82, ET 35

LED

1x 6W

warm  
WHITE

1x  
500lm



Ø 65



IP44



9 002759 959623



Ø 82





**96901**



**96902**

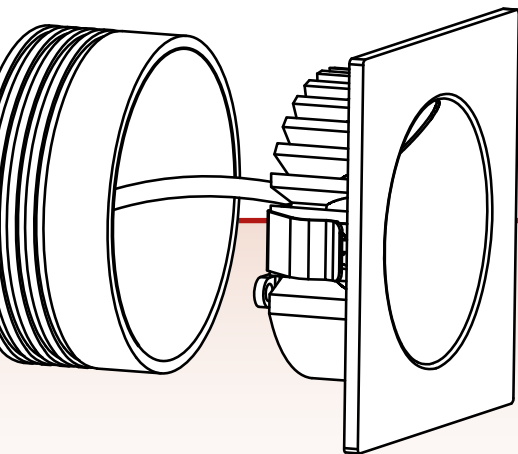

**96901 ZARATE**

recessed light; cast aluminium, white / plastic, white  
 Einbauleuchte; Aluguss, weiss / Kunststoff, weiss  
 luminaire encastrable; fonte d'aluminium, blanc / plastique, blanc

L 80, H 80, ET 40



**96902 ZARATE**

recessed light; cast aluminium, silver / plastic, white  
 Einbauleuchte; Aluguss, silber / Kunststoff, weiss  
 luminaire encastrable; fonte d'aluminium, argent / plastique, blanc

L 80, H 80, ET 40



**96901 & 96902**

including plaster ring

inklusive Einputzring

y compris l'anneau de plâtre





**99643**

LED



**99644**

LED



**99644**

LED

**99643 MECINOS**

recessed light; steel, white  
 Einbauleuchte; Stahl, weiss  
 luminaire encastrable; acier, blanc

L 80, B 80, H 3

LED

1x 2W

warm  
 WHITE

200lm



Ø65



9 002759 996437

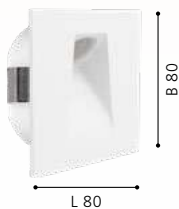

**99644 MECINOS**

recessed light; steel, black  
 Einbauleuchte; Stahl, schwarz  
 luminaire encastrable; acier, noir

L 80, B 80, H 3

LED

1x 2W

warm  
 WHITE

200lm



Ø65



9 002759 996444



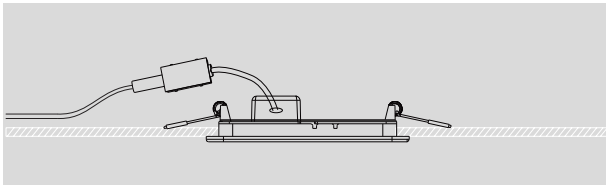

# RECESSED LUMINAIRES

## FUEVA 5

### ADVANTAGES

- > MODERN APPEARANCE - THE NEW FUEVA CONVINCES WITH ITS FLAT DESIGN AND NARROW FRAME.
- > THE FUEVA 5 IS AVAILABLE IN THE TREND COLOUR BLACK.
- > INCLUSIVE PLUG-IN TERMINAL - FOR QUICK WORK AND EASY HANDLING

---

### VORTEILE

- > MODERNES ERSCHEINUNGSBILD - DIE NEUE FUEVA ÜBERZEUGT DURCH IHR FLACHES DESIGN SOWIE DEN SCHMALEN RAHMEN.
- > DIE FUEVA 5 IST IN DER TRENDFARBE SCHWARZ ERHÄLTlich.
- > INKLUSIVE STECKKLEMME - FÜR DAS SCHNELLE ARBEITEN UND EINE EINFACHE HANDHABUNG

---







































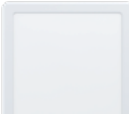





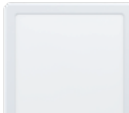

















### ADVANTAGES

- > APPARENCE MODERNE - LE NOUVEAU FUEVA CONVAINC PAR SON DESIGN PLAT ET SON CADRE ÉTROIT.
- > LE FUEVA 5 EST DISPONIBLE DANS LA COULEUR TENDANCE NOIRE.
- > Y COMPRIS UNE BORNE ENFICHABLE - POUR UN TRAVAIL RAPIDE ET UNE MANIPULATION SIMPLE



# OVERVIEW

**5** year warranty  
 Jahre Garantie  
 ans de garantie  
 anni di garanzia  
 años de garantía

							
FUEVA 5 p. 140	FUEVA 5 p. 140	FUEVA 5 p. 140	FUEVA 5 p. 141	FUEVA 5 p. 141	FUEVA 5 p. 142	FUEVA 5 p. 142	FUEVA 5 p. 142
							
FUEVA 5 p. 143	FUEVA 5 p. 143	FUEVA 5 p. 144	FUEVA 5 p. 144	FUEVA 5 p. 144	FUEVA 5 p. 145	FUEVA 5 p. 145	FUEVA 5 p. 146
							
FUEVA 5 p. 146	FUEVA 5 p. 146	FUEVA 5 p. 147	FUEVA 5 p. 148	FUEVA 5 p. 148	FUEVA 5 p. 148	FUEVA 5 p. 149	FUEVA 5 p. 150
							
FUEVA 5 p. 150	FUEVA 5 p. 150	FUEVA 5 p. 151	FUEVA 5 p. 152	FUEVA 5 p. 152	FUEVA 5 p. 152	FUEVA 5 p. 153	FUEVA 5 p. 153
							
FUEVA 5 p. 153	FUEVA 5 p. 154	FUEVA 5 p. 154	FUEVA 5 p. 154	FUEVA 5 p. 155	FUEVA 5 p. 155	FUEVA 5 p. 155	FUEVA 5 p. 157
							
FUEVA 5 p. 157	FUEVA 5 p. 157	FUEVA 5 p. 159	FUEVA 5 p. 159	FUEVA 5 p. 159	FUEVA 5 p. 160	FUEVA 5 p. 160	FUEVA 5 p. 160
							
FUEVA 5 p. 161	FUEVA 5 p. 162	FUEVA 5 p. 162	FUEVA 5 p. 162	FUEVA 5 p. 163	FUEVA 5 p. 164	FUEVA 5 p. 164	FUEVA 5 p. 164
							
FUEVA 5 p. 165	FUEVA FLEX p. 166	FUEVA FLEX p. 166	FUEVA FLEX p. 166	FUEVA FLEX p. 167	FUEVA FLEX p. 167	FUEVA FLEX p. 167	





99131



99133



99132



### 99131 FUEVA 5

recessed light; steel, white / plastic, white  
Einbauleuchte; Stahl, weiss / Kunststoff, weiss  
luminaire encastrable; acier, blanc / plastique, blanc

Ø 86, ET 26



2,7W 300lm

Ø 75



9 002759 991319



Ø 86

Ø 117, ET 26



5,5W 650lm

Ø 105



9 002759 991326



Ø 117

### 99133 FUEVA 5

recessed light; steel, white / plastic, white  
Einbauleuchte; Stahl, weiss / Kunststoff, weiss  
luminaire encastrable; acier, blanc / plastique, blanc

Ø 166, ET 26



10,5W 1200lm

Ø 155



9 002759 991333



Ø 166



99134



99135



### 99134 FUEVA 5

recessed light; steel, white / plastic, white  
Einbauleuchte; Stahl, weiss / Kunststoff, weiss  
luminaire encastrable; acier, blanc / plastique, blanc

Ø 216, ET 26



16,5 W



1800lm



Ø 205



### 99135 FUEVA 5

recessed light; steel, white / plastic, white  
Einbauleuchte; Stahl, weiss / Kunststoff, weiss  
luminaire encastrable; acier, blanc / plastique, blanc

Ø 86, ET 26



3x 2,7 W



3x  
300lm



Ø 75



9 002759 991340



Ø 216



9 002759 991357



Ø 86





99136



99138



99137



### 99136 FUEVA 5

recessed light; steel, satin nickel / plastic, white  
Einbauleuchte; Stahl, nickel-matt / Kunststoff, weiss  
luminaire encastrable; acier, nickel mat / plastique, blanc

Ø 86, ET 26



2,7W 300lm



9 002759 991364



Ø 86

### 99137 FUEVA 5

recessed light; steel, satin nickel / plastic, white  
Einbauleuchte; Stahl, nickel-matt / Kunststoff, weiss  
luminaire encastrable; acier, nickel mat / plastique, blanc

Ø 117, ET 26



5,5W 650lm



9 002759 991374



Ø 117

### 99138 FUEVA 5

recessed light; steel, satin nickel / plastic, white  
Einbauleuchte; Stahl, nickel-matt / Kunststoff, weiss  
luminaire encastrable; acier, nickel mat / plastique, blanc

Ø 166, ET 26



10,5W 1200lm



9 002759 991388



Ø 166



99139



99141



### 99139 FUEVA 5

recessed light; steel, satin nickel / plastic, white  
 Einbauleuchte; Stahl, nickel-matt / Kunststoff, weiss  
 luminaire encastrable; acier, nickel mat / plastique, blanc

Ø 216, ET 26



16,5 W 1800 lm



Ø 216

### 99141 FUEVA 5

recessed light; steel, satin nickel / plastic, white  
 Einbauleuchte; Stahl, nickel-matt / Kunststoff, weiss  
 luminaire encastrable; acier, nickel mat / plastique, blanc

Ø 86, ET 26



3x 2,7 W 3x 300 lm



Ø 86



9 002759 991395



9 002759 991418





99142

LED



99144

LED



99143

LED

### 99142 FUEVA 5

recessed light; steel, black / plastic, white  
Einbauleuchte; Stahl, schwarz / Kunststoff, weiss  
luminaire encastrable; acier, noir / plastique, blanc

Ø 86, ET 26



2,7W 300lm

Ø 75



9 002759 991425



Ø 86

### 99143 FUEVA 5

recessed light; steel, black / plastic, white  
Einbauleuchte; Stahl, schwarz / Kunststoff, weiss  
luminaire encastrable; acier, noir / plastique, blanc

Ø 117, ET 26



5,5W 650lm

Ø 105



9 002759 991432



Ø 117

### 99144 FUEVA 5

recessed light; steel, black / plastic, white  
Einbauleuchte; Stahl, schwarz / Kunststoff, weiss  
luminaire encastrable; acier, noir / plastique, blanc

Ø 166, ET 26



10,5W 1200lm

Ø 155



9 002759 991449



Ø 166



99145



99146



### 99145 FUEVA 5

recessed light; steel, black / plastic, white  
Einbauleuchte; Stahl, schwarz / Kunststoff, weiss  
luminaire encastrable; acier, noir / plastique, blanc

Ø 216, ET 26



16,5 W

1800 lm

Ø 205

### 99146 FUEVA 5

recessed light; steel, black / plastic, white  
Einbauleuchte; Stahl, schwarz / Kunststoff, weiss  
luminaire encastrable; acier, noir / plastique, blanc

Ø 86, ET 26



3x 2,7 W

3x  
300 lm

Ø 75



9 002759 991456



Ø 216



9 002759 991463



Ø 86







99147

LED



99149

LED



99148

LED

### 99147 FUEVA 5

recessed light; steel, white / plastic, white  
Einbauleuchte; Stahl, weiss / Kunststoff, weiss  
luminaire encastrable; acier, blanc / plastique, blanc

Ø 86, ET 26



2,7W 360lm

Ø 75



9 002759 991470



Ø 86

### 99148 FUEVA 5

recessed light; steel, white / plastic, white  
Einbauleuchte; Stahl, weiss / Kunststoff, weiss  
luminaire encastrable; acier, blanc / plastique, blanc

Ø 117, ET 26



5,5W 700lm

Ø 105



9 002759 991487



Ø 117

### 99149 FUEVA 5

recessed light; steel, white / plastic, white  
Einbauleuchte; Stahl, weiss / Kunststoff, weiss  
luminaire encastrable; acier, blanc / plastique, blanc

Ø 166, ET 26



10,5W 1350lm

Ø 155



9 002759 991494



Ø 166



99151

LED



99151

LED

### 99151 FUEVA 5

recessed light; steel, white / plastic, white  
Einbauleuchte; Stahl, weiss / Kunststoff, weiss  
luminaire encastrable; acier, blanc / plastique, blanc

Ø 216, ET 26

LED

16,5 W

neutral  
WHITE

2000lm



Ø205



9 002759 991517



Ø 216



99152

LED



99154

LED



99153

LED

### 99152 FUEVA 5

recessed light; steel, satin nickel / plastic, white  
Einbauleuchte; Stahl, nickel-matt / Kunststoff, weiss  
luminaire encastrable; acier, nickel mat / plastique, blanc

Ø 86, ET 26



2,7W 360lm

Ø 75



9 002759 991524



Ø 86

### 99153 FUEVA 5

recessed light; steel, satin nickel / plastic, white  
Einbauleuchte; Stahl, nickel-matt / Kunststoff, weiss  
luminaire encastrable; acier, nickel mat / plastique, blanc

Ø 117, ET 26



5,5W 700lm

Ø 105



9 002759 991531



Ø 117

### 99154 FUEVA 5

recessed light; steel, satin nickel / plastic, white  
Einbauleuchte; Stahl, nickel-matt / Kunststoff, weiss  
luminaire encastrable; acier, nickel mat / plastique, blanc

Ø 166, ET 26



10,5W 1350lm

Ø 155



9 002759 991548



Ø 166



99155

LED

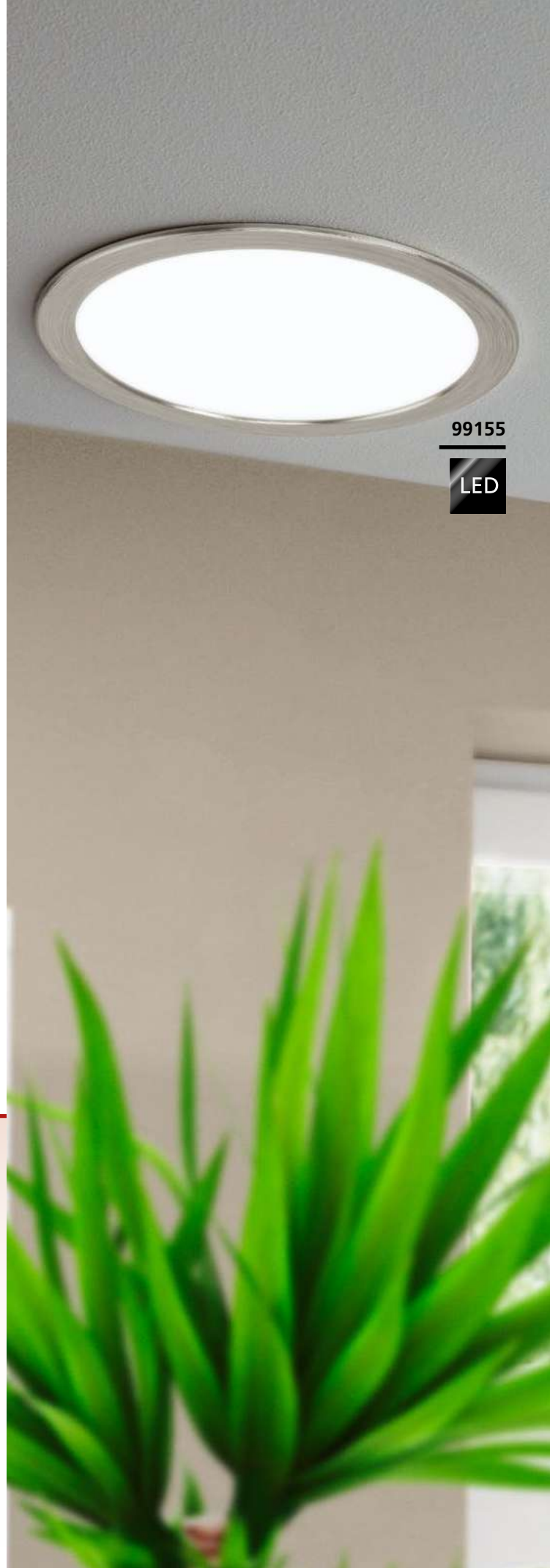

99155

LED

### 99155 FUEVA 5

recessed light; steel, satin nickel / plastic, white  
Einbauleuchte; Stahl, nickel-matt / Kunststoff, weiss  
luminaire encastrable; acier, nickel mat / plastique, blanc

Ø 216, ET 26

LED

16,5W

neutral  
WHITE

2000lm



Ø205



9 002759 991555



Ø 216



99156

LED



99158

LED



99157

LED

### 99156 FUEVA 5

recessed light; steel, black / plastic, white  
Einbauleuchte; Stahl, schwarz / Kunststoff, weiss  
luminaire encastrable; acier, noir / plastique, blanc

Ø 86, ET 26



2,7W 360lm

Ø 75



9 002759 991562



Ø 86

### 99157 FUEVA 5

recessed light; steel, black / plastic, white  
Einbauleuchte; Stahl, schwarz / Kunststoff, weiss  
luminaire encastrable; acier, noir / plastique, blanc

Ø 117, ET 26



5,5W 700lm

Ø 105



9 002759 991579



Ø 117

### 99158 FUEVA 5

recessed light; steel, black / plastic, white  
Einbauleuchte; Stahl, schwarz / Kunststoff, weiss  
luminaire encastrable; acier, noir / plastique, blanc

Ø 166, ET 26



10,5W 1350lm

Ø 155



9 002759 991586



Ø 166



99159

LED

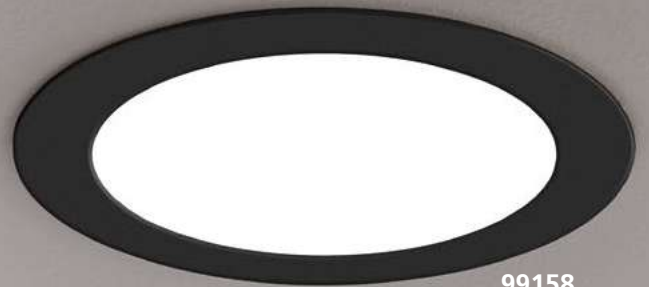

99158

LED

### 99159 FUEVA 5

recessed light; steel, black / plastic, white  
Einbauleuchte; Stahl, schwarz / Kunststoff, weiss  
luminaire encastrable; acier, noir / plastique, blanc

Ø 216, ET 26

LED

16,5 W

neutral  
WHITE

2000lm



Ø 205



9 002759 991593



Ø 216



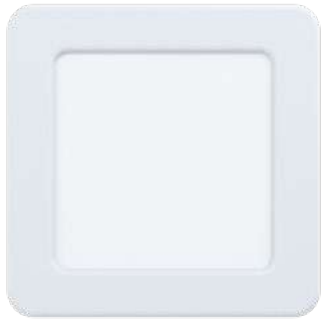

99162



99164

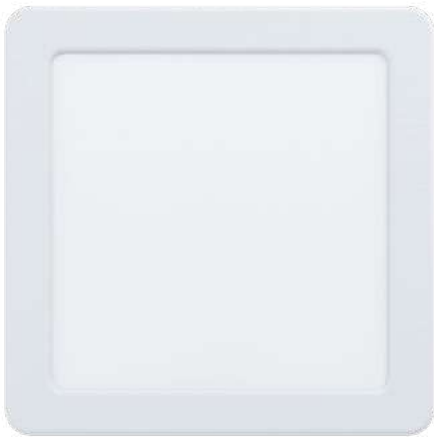

99163



### 99162 FUEVA 5

recessed light; steel, white / plastic, white  
Einbauleuchte; Stahl, weiss / Kunststoff, weiss  
luminaire encastrable; acier, blanc / plastique, blanc

L 117, B 117, ET 26



5,5W 650lm 105x105



9 002759 991623

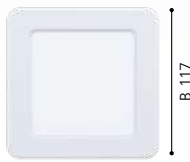

L 117



9 002759 991630



L 166, B 166, ET 26



10,5W 1200lm 155x155



L 166

### 99164 FUEVA 5

recessed light; steel, white / plastic, white  
Einbauleuchte; Stahl, weiss / Kunststoff, weiss  
luminaire encastrable; acier, blanc / plastique, blanc

L 216, B 216, ET 26



16,5W 1800lm 205x205



9 002759 991647

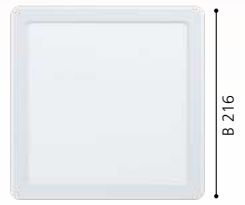

L 216



99167

LED



99169

LED



99168

LED

### 99167 FUEVA 5

recessed light; steel, satin nickel / plastic, white  
Einbauleuchte; Stahl, nickel-matt / Kunststoff, weiss  
luminaire encastrable; acier, nickel mat / plastique, blanc

L 117, B 117, ET 26



5,5W 650lm

105x105



9 002759 991678

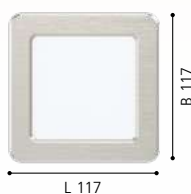

### 99168 FUEVA 5

recessed light; steel, satin nickel / plastic, white  
Einbauleuchte; Stahl, nickel-matt / Kunststoff, weiss  
luminaire encastrable; acier, nickel mat / plastique, blanc

L 166, B 166, ET 26



10,5W 1200lm

155x155



9 002759 991685



### 99169 FUEVA 5

recessed light; steel, satin nickel / plastic, white  
Einbauleuchte; Stahl, nickel-matt / Kunststoff, weiss  
luminaire encastrable; acier, nickel mat / plastique, blanc

L 216, B 216, ET 26



16,5W 1800lm

205x205



9 002759 991692



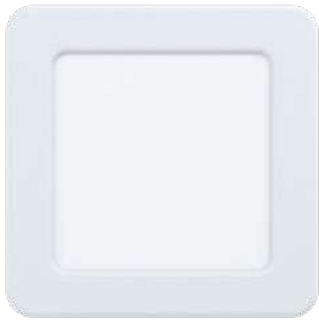

99178



99181

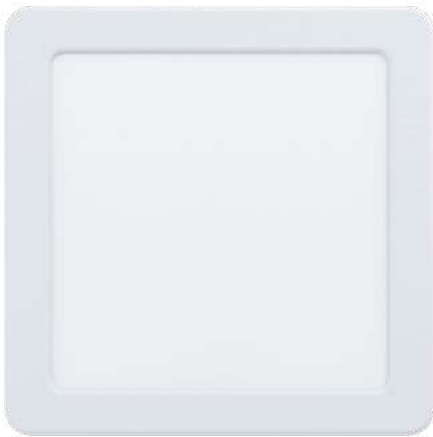

99179



### 99178 FUEVA 5

recessed light; steel, white / plastic, white  
Einbauleuchte; Stahl, weiss / Kunststoff, weiss  
luminaire encastrable; acier, blanc / plastique, blanc

L 117, B 117, ET 26



5,5W 700lm 105x105



9 002759 991784

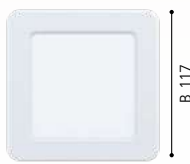

L 117



9 002759 991791



L 166, B 166, ET 26



10,5W 1350lm 155x155

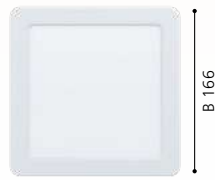

L 166

### 99181 FUEVA 5

recessed light; steel, white / plastic, white  
Einbauleuchte; Stahl, weiss / Kunststoff, weiss  
luminaire encastrable; acier, blanc / plastique, blanc

L 216, B 216, ET 26



16,5W 2000lm 205x205



9 002759 991814

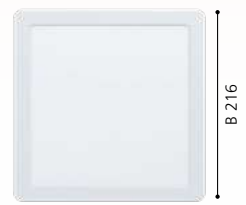

L 216

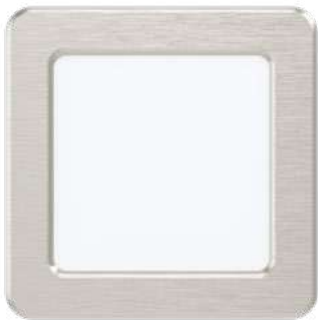

99183

LED



99185

LED



99184

LED

### 99183 FUEVA 5

recessed light; steel, satin nickel / plastic, white  
Einbauleuchte; Stahl, nickel-matt / Kunststoff, weiss  
luminaire encastrable; acier, nickel mat / plastique, blanc

L 117, B 117, ET 26

LED

5,5W

neutral  
WHITE

700lm



105x105



9 002759 991838

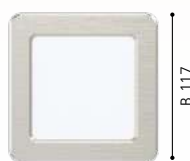

L 117

B 117

### 99184 FUEVA 5

recessed light; steel, satin nickel / plastic, white  
Einbauleuchte; Stahl, nickel-matt / Kunststoff, weiss  
luminaire encastrable; acier, nickel mat / plastique, blanc

L 166, B 166, ET 26

LED

10,5W

neutral  
WHITE

1350lm



155x155



9 002759 991845



L 166

B 166

### 99185 FUEVA 5

recessed light; steel, satin nickel / plastic, white  
Einbauleuchte; Stahl, nickel-matt / Kunststoff, weiss  
luminaire encastrable; acier, nickel mat / plastique, blanc

L 216, B 216, ET 26

LED

16,5W

neutral  
WHITE

2000lm



205x205



9 002759 991852



L 216

B 216



99187

LED





99187

LED

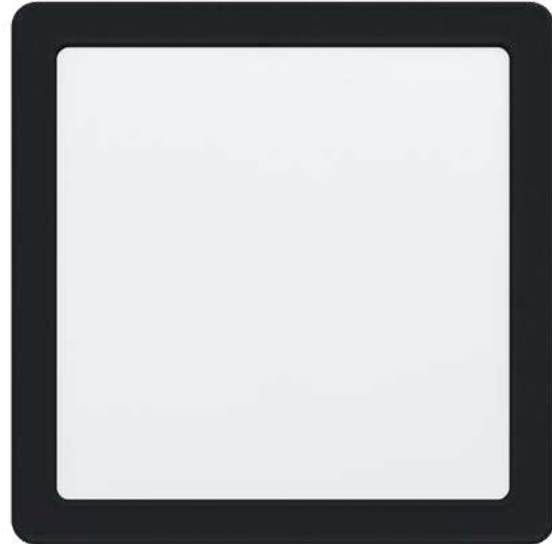

99189

LED

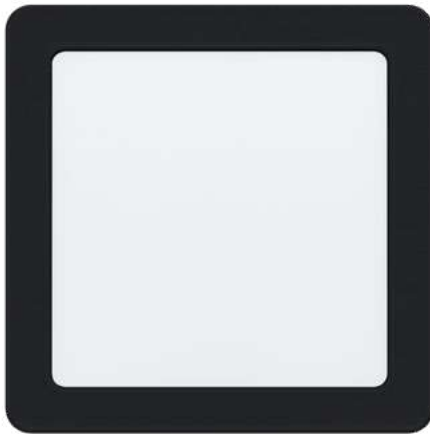

99188

LED

### 99187 FUEVA 5

recessed light; steel, black / plastic, white  
Einbauleuchte; Stahl, schwarz / Kunststoff, weiss  
luminaire encastrable; acier, noir / plastique, blanc

L 117, B 117, ET 26



5,5W 700lm 105x105



9 002759 991876

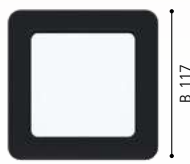

L 117

B 117

### 99188 FUEVA 5

recessed light; steel, black / plastic, white  
Einbauleuchte; Stahl, schwarz / Kunststoff, weiss  
luminaire encastrable; acier, noir / plastique, blanc

L 166, B 166, ET 26



10,5W 1350lm 155x155



9 002759 991883



L 166

B 166

### 99189 FUEVA 5

recessed light; steel, black / plastic, white  
Einbauleuchte; Stahl, schwarz / Kunststoff, weiss  
luminaire encastrable; acier, noir / plastique, blanc

L 216, B 216, ET 26



16,5W 2000lm 205x205



9 002759 991890



L 216

B 216





99191

LED





99191



99193



99192



### 99191 FUEVA 5

recessed light; steel, white / plastic, white  
Einbauleuchte; Stahl, weiss / Kunststoff, weiss  
luminaire encastrable; acier, blanc / plastique, blanc

Ø 117, ET 26



5,5W



650lm



Ø 105



9 002759 991913



Ø 117

### 99192 FUEVA 5

recessed light; steel, white / plastic, white  
Einbauleuchte; Stahl, weiss / Kunststoff, weiss  
luminaire encastrable; acier, blanc / plastique, blanc

Ø 166, ET 26



10,5W



1200lm



Ø 155



9 002759 991920



Ø 166

### 99193 FUEVA 5

recessed light; steel, white / plastic, white  
Einbauleuchte; Stahl, weiss / Kunststoff, weiss  
luminaire encastrable; acier, blanc / plastique, blanc

Ø 216, ET 26



16,5W



1800lm



Ø 205



9 002759 991937



Ø 216



99202



IP44



99203



IP44



99206



IP44

### 99202 FUEVA 5

recessed light; steel, white / plastic, white  
Einbauleuchte; Stahl, weiss / Kunststoff, weiss  
luminaire encastrable; acier, blanc / plastique, blanc

### 99206 FUEVA 5

recessed light; steel, white / plastic, white  
Einbauleuchte; Stahl, weiss / Kunststoff, weiss  
luminaire encastrable; acier, blanc / plastique, blanc

### 99203 FUEVA 5

recessed light; steel, white / plastic, white  
Einbauleuchte; Stahl, weiss / Kunststoff, weiss  
luminaire encastrable; acier, blanc / plastique, blanc

Ø 86, ET 26



9 002759 992026



Ø 86

Ø 86, ET 26



9 002759 992064



Ø 86

Ø 166, ET 26



9 002759 992033



Ø 166



99207

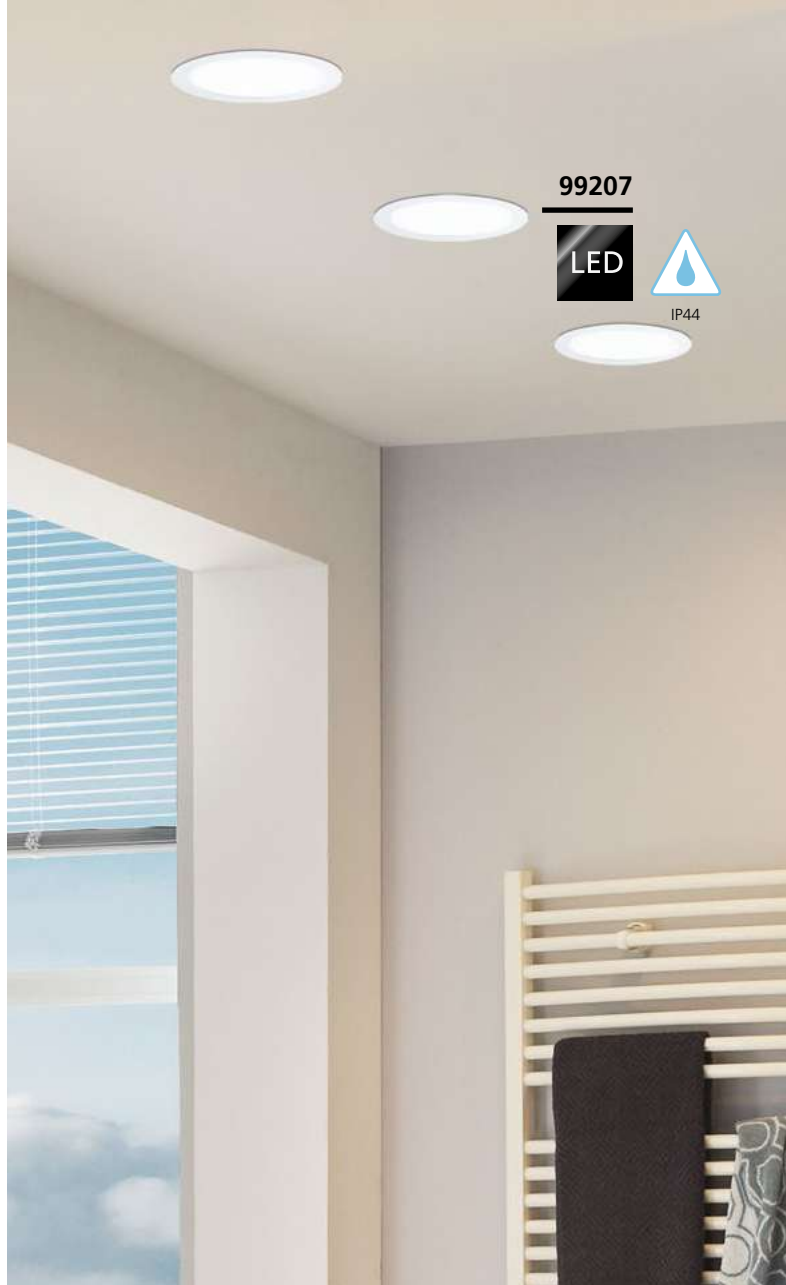

99207



IP44

### 99207 FUEVA 5

recessed light; steel, white / plastic, white  
 Einbauleuchte; Stahl, weiss / Kunststoff, weiss  
 luminaire encastrable; acier, blanc / plastique, blanc

Ø 166, ET 26



9 002759 992071



### FUEVA 5

These luminaires are protected against splash water.

Diese Leuchten sind gegen Spritzwasser geschützt.

Les luminaires sont protégées contre les éclaboussures d'eau.



IP44		EU	X	X	✓	✓
		FR	X	X	X	✓



99204



IP44



99205



IP44



99208



IP44

### 99204 FUEVA 5

recessed light; steel, chrome / plastic, white  
Einbauleuchte; Stahl, chrom / Kunststoff, weiss  
luminaire encastrable; acier, chrome / plastique, blanc

Ø 86, ET 26



2,7W 300lm Ø75 IP44



9 002759 992040



Ø 86

### 99208 FUEVA 5

recessed light; steel, chrome / plastic, white  
Einbauleuchte; Stahl, chrom / Kunststoff, weiss  
luminaire encastrable; acier, chrome / plastique, blanc

Ø 86, ET 26



2,7W 360lm Ø75 IP44



9 002759 992088



Ø 86

### 99205 FUEVA 5

recessed light; steel, chrome / plastic, white  
Einbauleuchte; Stahl, chrom / Kunststoff, weiss  
luminaire encastrable; acier, chrome / plastique, blanc

Ø 166, ET 26



10,5W 1200lm Ø155 IP44



9 002759 992057



Ø 166



**99209**



IP44

### 99209 FUEVA 5

recessed light; steel, chrome / plastic, white  
Einbauleuchte; Stahl, chrom / Kunststoff, weiss  
luminaire encastrable; acier, chrome / plastique, blanc

Ø 166, ET 26

LED

10,5W

neutral  
WHITE

1350lm



Ø 155



IP44



Ø 166



9 002759 992095



**99204**



IP44





99211



IP44



99212



IP44



99213



IP44

### 99211 FUEVA 5

recessed light; steel, black / plastic, white  
Einbauleuchte; Stahl, schwarz / Kunststoff, weiss  
luminaire encastrable; acier, noir / plastique, blanc

Ø 86, ET 26



9 002759 992118



Ø 86

### 99213 FUEVA 5

recessed light; steel, black / plastic, white  
Einbauleuchte; Stahl, schwarz / Kunststoff, weiss  
luminaire encastrable; acier, noir / plastique, blanc

Ø 86, ET 26



9 002759 992132



Ø 86

### 99212 FUEVA 5

recessed light; steel, black / plastic, white  
Einbauleuchte; Stahl, schwarz / Kunststoff, weiss  
luminaire encastrable; acier, noir / plastique, blanc

Ø 166, ET 26



9 002759 992125



Ø 166



99214



99211



### 99214 FUEVA 5

recessed light; steel, black / plastic, white  
Einbauleuchte; Stahl, schwarz / Kunststoff, weiss  
luminaire encastrable; acier, noir / plastique, blanc

Ø 166, ET 26

LED

10,5W

neutral  
WHITE

1350lm



Ø 155



IP44



Ø 166



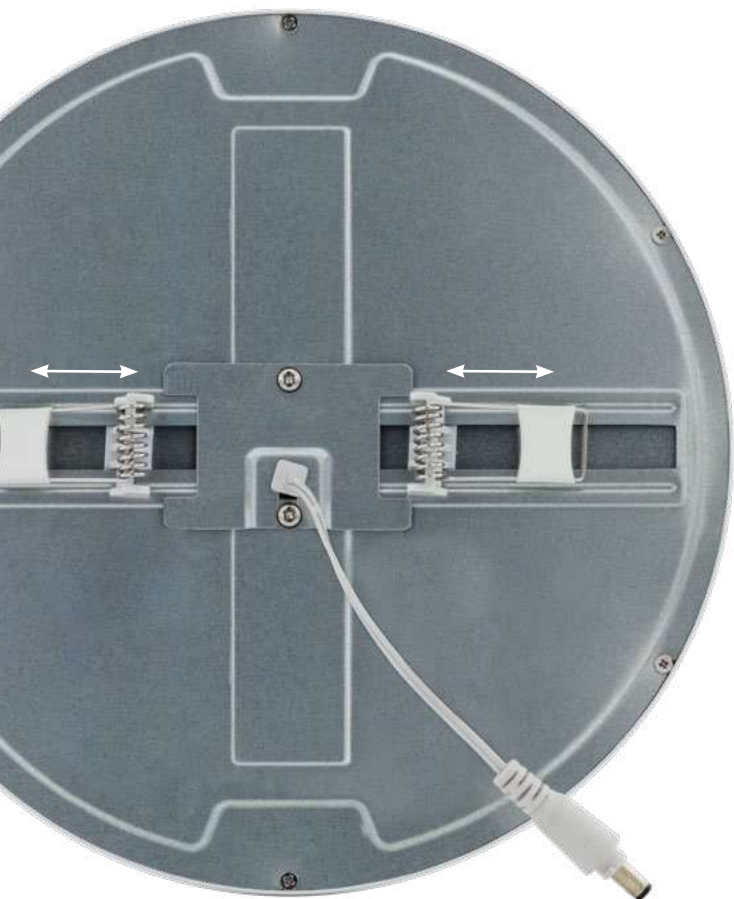

### FUEVA FLEX

Flexible mounting bracket for various ceiling cut-outs from 50-210 mm.

Flexibler Einbaubügel für verschiedene Deckenausschnitte von 50-210 mm.

Support de montage flexible pour différentes découpes de plafond de 50 à 210 mm.



**98865**



**98866**



**98867**



### 98865 FUEVA FLEX

recessed light; aluminium, white / plastic, white  
 Einbauleuchte; Alu, weiss / Kunststoff, weiss  
 luminaire encastrable; aluminium, blanc / plastique, blanc

H 25, Ø 225



### 98866 FUEVA FLEX

recessed light; aluminium, satin nickel / plastic, white  
 Einbauleuchte; Alu, nickel-matt / Kunststoff, weiss  
 luminaire encastrable; aluminium, nickel mat / plastique, blanc

H 25, Ø 225



### 98867 FUEVA FLEX

recessed light; aluminium, black / plastic, white  
 Einbauleuchte; Alu, schwarz / Kunststoff, weiss  
 luminaire encastrable; aluminium, noir / plastique, blanc

H 25, Ø 225





98868



98869



98871



98871



### 98868 FUEVA FLEX

recessed light; aluminium, white / plastic, white  
Einbauleuchte; Alu, weiss / Kunststoff, weiss  
luminaire encastrable; aluminium, blanc / plastique, blanc

H 25, Ø 225



24W 2700lm Ø50-210



9 002759 988685



Ø 225



### 98869 FUEVA FLEX

recessed light; aluminium, satin nickel / plastic, white  
Einbauleuchte; Alu, nickel-matt / Kunststoff, weiss  
luminaire encastrable; aluminium, nickel mat / plastique, blanc

H 25, Ø 225



24W 2700lm Ø50-210



9 002759 988692



Ø 225



### 98871 FUEVA FLEX

recessed light; aluminium, black / plastic, white  
Einbauleuchte; Alu, schwarz / Kunststoff, weiss  
luminaire encastrable; aluminium, noir / plastique, blanc

H 25, Ø 225



24W 2700lm Ø50-210



9 002759 988715



Ø 225





# RECESSED LUMINAIRES

## LOW VOLTAGE

### ADVANTAGES

- > SLIM DESIGN WITH MINIMAL INSTALLATION DEPTH, MAKING IT IDEAL FOR CEILING STRUCTURES WITH LITTLE SPACE
- > UNIFORM DISTRIBUTION OF LIGHT - IDEAL FOR ILLUMINATING SPACES AND SURFACES
- > LOW TEMPERATURE ENHANCES SAFETY
- > PLEASANT WARM WHITE LIGHT COLOR
- > LOW TEMPERATURE ENHANCES SAFETY
- > UP TO 80% POWER SAVINGS COMPARED TO INCANDESCENT LAMPS. EASY ON YOUR BUDGET AND THE ENVIRONMENT
- > IMPL. CABLING THROUGH INTEGRATED TERMINAL CONNECTOR ON DRIVER

---

### VORTEILE

- > SCHLANKE BAUFORM MIT MINIMALER EINBAUTIEFE, DAHER IDEAL FÜR DECKEN-KONSTRUKTIONEN MIT WENIG PLATZ
- > HOMOGENE LICHTVERTEILUNG - IDEAL ZUR BELEUCHTUNG VON RÄUMEN UND FLÄCHEN
- > GERINGE WÄRMEENTWICKLUNG SORGT FÜR MEHR SICHERHEIT
- > BIS ZU 80% STROMERSPARNIS GEGENÜBER GLÜHLAMPEN, SCHONT IHR BUDGET UND DIE UMWELT
- > EINFACHE VERKABELUNG DURCH INTEGRIERTEN KLEMMANSCHLUSS AM TREIBER

---

### ADVANTAGES

- > CONCEPTION MINCE AVEC LA PROFONDEUR D'INSTALLATION MINIMALE, IDÉAL POUR LES STRUCTURES DE PLAFOND AVEC PEU D'ESPACE
- > DISTRIBUTION UNIFORME DE LA LUMIÈRE - IDÉAL POUR L'ILLUMINATION DES ESPACES ET SURFACES
- > FAIBLE CHALEUR AMÉLIORE LA SÉCURITÉ
- > JUSQU'À 80% D'ÉCONOMIES D'ÉNERGIE PAR RAPPORT AUX LAMPES À INCANDESCENCE, RÉDUIT VOTRE BUDGET ET PROTÈGE L'ENVIRONNEMENT
- > BUDGET AND THE ENVIRONMENT
- > CÂBLAGE SIMPLE VIA LE CONNECTEUR DE TERMINAL INTÉGRÉ SUR CONDUCTEUR

# OVERVIEW

**5** year warranty  
Jahre Garantie  
ans de garantie  
anni di garanzia  
años de garantía



RONZANO 1  
p. 170



FIOBBO  
p. 172



FIOBBO  
p. 172



CHANGO  
p. 174





98521



### 98521 RONZANO 1

recessed light; steel, white, silver

Einbauleuchte; Stahl, weiss, silber

luminaire encastrable; acier, blanc, argent

Ø 165, ET 50

LED

5W

warm  
WHITE

480lm



Ø145



9 002759 985219

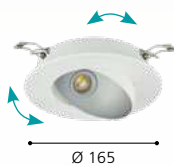

Ø 165



98521





97594

LED



97593

LED

### 97593 FIOBBO

recessed light; steel, white / plastic with crystal effect, white  
 Einbauleuchte; Stahl, weiss / Kunststoff m. Kristalleffekt, weiss  
 luminaire encastrable; acier, blanc / plastique avec effet cristal, blanc

H 50, Ø 225, ET 40



### 97594 FIOBBO

recessed light; steel, white / plastic with crystal effect, white  
 Einbauleuchte; Stahl, weiss / Kunststoff m. Kristalleffekt, weiss  
 luminaire encastrable; acier, blanc / plastique avec effet cristal, blanc

H 50, Ø 300, ET 40



97594

LED





97079



IP44

## CHANGO

- |   |  |  |
|---|--|--|
| <ul style="list-style-type: none"> <li>&gt; "Starry Sky" 3 Spot Set</li> <li>&gt; Simple installation</li> <li>&gt; Pre-assembled connecting box</li> <li>&gt; Plug &amp; Play</li> <li>&gt; Desktop driver</li> <li>&gt; Operable with 2 – 3 spotheads incl. short-connector</li> <li>&gt; Cable length = 2m</li> <li>&gt; Cutout dimension = 16 mm</li> </ul> | <ul style="list-style-type: none"> <li>&gt; "Sternenhimmel" 3 Spot Set</li> <li>&gt; Einfache Montage</li> <li>&gt; Vorkonfigurierte Anschlußbox</li> <li>&gt; Plug &amp; Play</li> <li>&gt; Desktop Treiber</li> <li>&gt; Verwendbar mit 2 – 3 Spotköpfen inkl. Verbinder</li> <li>&gt; Kabellänge = 2m</li> <li>&gt; Ausschnitt Durchmesser = 16 mm</li> </ul> | <ul style="list-style-type: none"> <li>&gt; Ensemble 3 spots " Ciel étoilé "</li> <li>&gt; Installation simple</li> <li>&gt; Boîte de connexion pré-assemblée</li> <li>&gt; Branchez &amp; jouez</li> <li>&gt; Pilote de bureau</li> <li>&gt; Utilisable avec 2 à 3 têtes incl. connecteur court</li> <li>&gt; Longueur du câble = 2m</li> <li>&gt; Cote de découpe = 16 mm</li> </ul> |
|---|--|--|

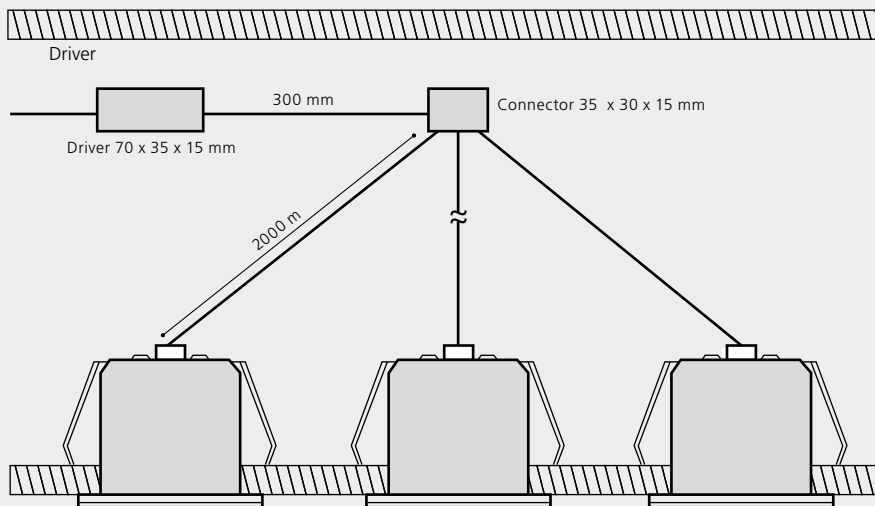

## 97079 CHANGO

recessed light; aluminium, white  
Einbauleuchte; Alu, weiss  
luminaire encastrable; aluminium, blanc

H 22, Ø 32, ET 25

LED

3x 1W

warm  
WHITE

3x 100lm



Ø 15



IP44



9 002759 970796







97079

LED



IP44



# EGLO TRACK SYSTEMS

## NEW AND MULTIFUNCTIONAL

### ADVANTAGES

- > LED PHASE SYSTEMS ARE INCREASING IN POPULARITY, WHETHER IN LIVING SPACES OR AS ACCENT LIGHTING: NOWADAYS THEY ARE FOUND THROUGHOUT THE INTERIOR FINISH.
  - > LED LIGHTING PANELS AND LIGHT FIXTURES OFFER UNMATCHED FLEXIBILITY.
  - > EGLO HAS DEVELOPED TWO LED LIGHTING PANEL SYSTEMS:  
**EGLO TRACK PRO** IS OUR COMPLEX LINEAR SYSTEM FOR THE TRADE SECTOR, NOW ADAPTED FOR DIY CUSTOMERS. HIGH-QUALITY, ROBUST MATERIALS GUARANTEE A LONG SERVICE LIFE.  
**EGLO TRACK BASIC** IS THE MOST USER-FRIENDLY SINGLE-PHASE SYSTEM ON THE MARKET. ALL OUR EGLO TRACK SYSTEMS CAN BE USED TO SET THE SCENE IN A ROOM, SPACE OR AROUND AN OBJECT.
  - > THE NEW SYSTEM OFFERS DIVERSE, FLEXIBLE POSSIBILITIES FOR ILLUMINATING ARCHITECTURE, INTERIORS OR EVEN INDIVIDUAL OBJECTS TO THEIR BEST EFFECT AND CREATING ATMOSPHERE IN A ROOM.
- 

### VORTEILE

- > LED-PHASENSYSTEME FINDEN IMMER MEHR ANWENDUNG - IM WOHNRAUM, ODER AUCH ALS AKZENTBELEUCHTUNG - MITTLERWEILE ALSO IM GESAMTEN BEREICH DES INNENAUSBAUS.
  - > LED-LICHTLEISTEN UND LEUCHTEN SIND SO FLEXIBEL EINSETZBAR, WIE KEIN ANDERES LEUCHTMITTEL. EGLO HAT HIERBEI ZWEI SYSTEME ENTWICKELT:  
**EGLO TRACK PRO:** DAS KOMPLEXE LINEARSYSTEM AUS DEM PROFESSIONALSEKTOR FÜR DIE DIY-KUNDEN. HOCHWERTIGE, ROBUSTE MATERIALIEN GARANTIEREN LANGLEBIGE PRODUKTE.  
**EGLO TRACK BASIC:** DAS BEDIENERFREUNDLICHSTE EINPHASENSYSTEM AM MARKT. DIE EGLO TRACKSYSTEME ERMÖGLICHEN AUCH HIER GEZIELTE INSZENIERUNG VON RÄUMEN, FLÄCHEN ODER GEGENSTÄNDEN.
  - > INSGESAMT BIETET DAS NEUE SYSTEM VIELSEITIGE MÖGLICHKEITEN ARCHITEKTUR, INTERIEUR ABER AUCH EINZELNE GEGENSTÄNDE INS RICHTIGE LICHT ZU RÜCKEN UND DEN RAUM MIT ATMOSPHERE ZU FÜLLEN.
- 

### ADVANTAGES

- > LES SYSTÈMES DE PHASES LED SONT DE PLUS EN PLUS UTILISÉS DANS LA DÉCORATION INTÉRIEURE : COMME ÉCLAIRAGE PRINCIPAL DANS LES PIÈCES DE VIE OU COMME ÉCLAIRAGE D'APPOINT.
- > LES LUMINAIRES ET LES RAILS À LED SONT PLUS FLEXIBLES QUE TOUTE AUTRE SOURCE DE LUMIÈRE. EGLO A DÉVELOPPÉ DEUX SYSTÈMES.  
**EGLO TRACK PRO :** LE SYSTÈME LINÉAIRE COMPLEXE DU SECTEUR PROFESSIONNEL POUR LES CLIENTS PARTICULIERS. DES MATÉRIAUX ROBUSTES DE HAUTE QUALITÉ GARANTISSENT LA LONGÉVITÉ DES PRODUITS.  
**EGLO TRACK BASIC :** LE SYSTÈME MONOPHASÉ LE PLUS CONVIVAL DU MARCHÉ. LES SYSTÈMES DE RAILS EGLO PERMETTENT ÉGALEMENT DE METTRE EN AVANT DE MANIÈRE CIBLÉE DES PIÈCES, DES SURFACES OU DES OBJETS.
- > AINSI, CE NOUVEAU SYSTÈME OFFRE DE NOMBREUSES POSSIBILITÉS POUR METTRE EN LUMIÈRE L'ARCHITECTURE, L'INTÉRIEUR OU ENCORE LES OBJETS ET DONNER UNE CERTAINE AMBIANCE À UNE PIÈCE.

























# OVERVIEW

**5** year warranty  
 Jahre Garantie  
 anni di garanzia  
 años de garantía  
 años de garantía

## EGLO TRACK SYSTEMS **BASIC**

 TB TRACK S p. 180	 TB TRACK L p. 180	 TB CONNECTOR p. 180	 TB MIDDLE FEEDER p. 181	 TB CORNER CONNECT p. 181	 TB ADAPTER p. 181	 TB TRACK S p. 182	 TB TRACK L p. 182
 TB CONNECTOR p. 182	 TB MIDDLE FEEDER p. 183	 TB CORNER CONNECT p. 183	 TB ADAPTER p. 183	 TB NEWTOWN p. 184	 TB CASIBARE p. 184	 TB CORTENOVA p. 184	 TB CORTENOVA p. 185
 TB CORTADERAS p. 185	 TB CORTADERAS p. 185	 TB SERAS p. 186	 TB SERAS p. 186	 TB SPOTLIGHT p. 186	 TB SPOTLIGHT p. 187	 TB SET p. 187	 TB SET p. 187

## EGLO TRACK SYSTEMS **PRO**

 TP TRACK p. 190	 TP TRACK p. 190	 TP TRACK p. 190	 TP CUBE CONNECTOR p. 191	 TP CUBE CONNECTOR p. 191	 TP CUBE CONNECTOR p. 191	 TP LIGHT INSERT S p. 192	 TP LIGHT INSERT L p. 192
 TP BLIND COVER S p. 194	 TP BLIND COVER S p. 194	 TP BLIND COVER S p. 194	 TP BLIND COVER L p. 195	 TP BLIND COVER L p. 195	 TP BLIND COVER L p. 195	 TP SUSPENSION p. 196	 TP CANOPY p. 197
 TP CANOPY p. 197	 TP CANOPY p. 197	 TP PENDANT LIGHT p. 198	 TP PENDANT LIGHT p. 198	 TP PENDANT LIGHT p. 198	 TP DOWNLIGHT p. 200	 TP DOWNLIGHT p. 200	 TP DOWNLIGHT p. 200
 TP SPOTLIGHT p. 201	 TP SPOTLIGHT p. 201	 TP SPOTLIGHT p. 201					

# EGLO TRACK SYSTEMS

## BASIC

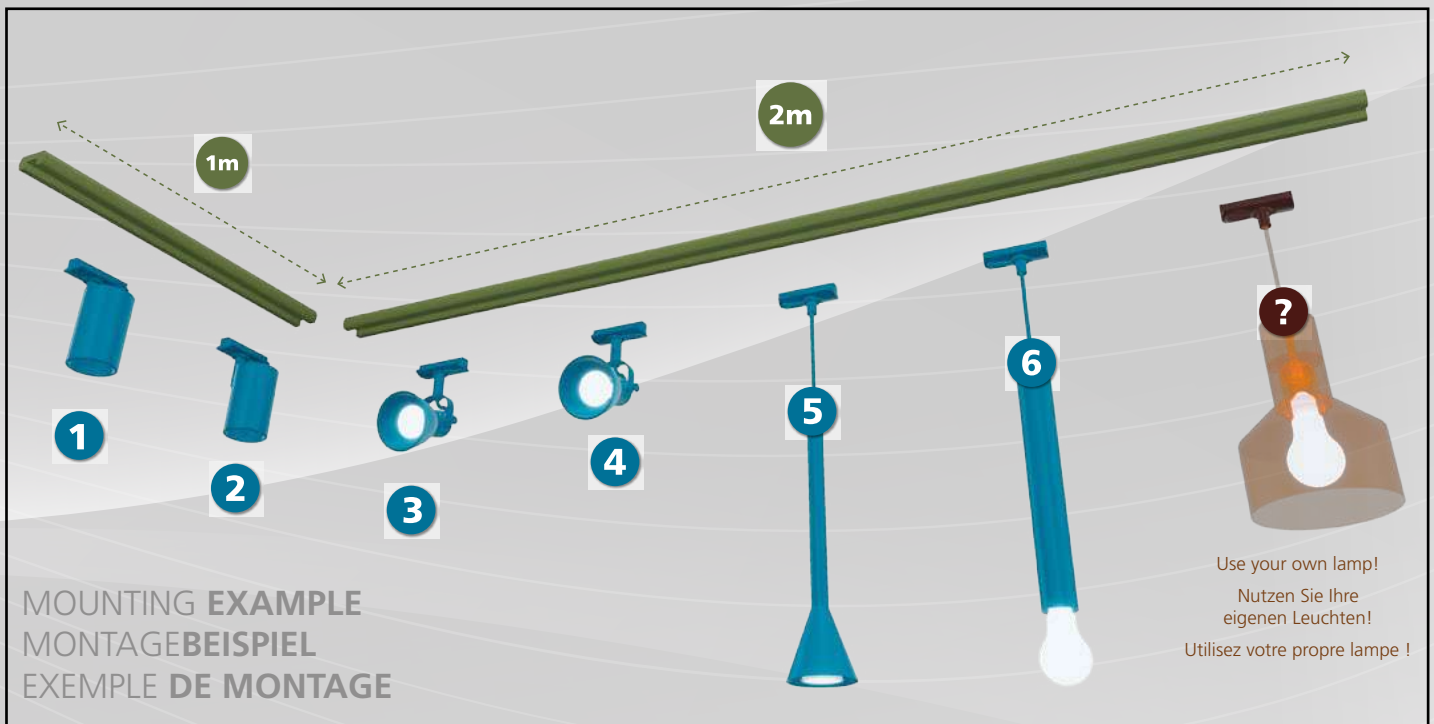

## IN GENERAL/ ALLGEMEINES/ CARACTÉRISQUES GÉNÉRALES

- > the most user-friendly product/ Das nutzerfreundlichste Produkt/ Particulièrement ergonomique.
- > lighting-highlights have been adapted, and are now ready to use with the **BASIC** system./ Die Spots wurden angepasst und können nun mit dem BASIC-System verwendet werden./ Les principales propriétés d'éclairage ont été adaptées et peuvent maintenant être utilisées avec le système BASIC.
- > left- and right mounting with flexible **corner-connector**. Use the straight connector to attach the track in line./ Links- und Rechtsmontage mit flexiblem Eckverbinder. Verwenden Sie den geraden Verbinder, um die Schienen (Tracks) in Reihe zu verbinden/ Montage à gauche et à droite grâce au connecteur coudé flexible. Utilisez le connecteur droit pour fixer le rail en ligne droite.
- > available in the trend colors:/ verfügbar in den Trendfarben:/ Disponible en deux coloris tendance :

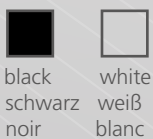

## EGLO TRACK **BASIC**

1

You can get the track in two different sizes: 1m + 2m. Install them on the ceiling and connect the tracks (left, right or straight) by using the flexible corner connector.

Sie können die Tracks in zwei verschiedenen Größen erhalten: 1 m + 2 m. Montieren Sie sie an der Decke und verbinden Sie die Tracks mithilfe des flexiblen Eckverbinders nach links, rechts oder geradeaus.

Rail disponible en deux tailles : 1 m + 2 m. Montez-les au plafond et connectez les rails à gauche, à droite ou tout droit à l'aide du connecteur d'angle flexible.

2

Choose your favourite LIGHT FIXTURES by clicking them into the track, easily.

Wählen Sie Ihre bevorzugten Beleuchtungselemente, indem Sie sie einfach in die Schiene einklicken.

Choisissez vos luminaires préférés et clipsez-les facilement dans le rail.

3

STAY FLEXIBLE - use the adapter to hang in a lamp, that you have at home.

Blieben sie flexibel - verwenden Sie den Adapter, um eine bereits vorhandene Leuchte einzuhängen,.

Une flexibilité en toutes Circonstances : si vous avez déjà une lampe chez vous, utilisez l'adaptateur pour la suspendre.



## ADVANTAGES

- > THE SINGLE-PHASE SYSTEM IS THE MOST USER-FRIENDLY PRODUCT ON THE MARKET.
  - > USE THE EGLO TRACK SYSTEMS TO SET THE SCENE IN A ROOM, SPACE OR AROUND AN OBJECT.
  - > EGLO'S DECORATIVE HIGHLIGHTS FOR LIVING SPACES HAVE BEEN INTEGRATED INTO THE SINGLE-PHASE SYSTEM. AN ADAPTER IS AVAILABLE THAT LETS YOU INTEGRATE YOUR OWN LIGHT FIXTURES INTO THE SYSTEM.
  - > THE LONGITUDINAL CONNECTORS ON THE RAIL SYSTEM MAKE IT SUPERBLY EASY TO EXTEND.
  - > THE SYSTEM ALSO HAS FLEXIBLE CORNER CONNECTORS WITH BALL JOINTS, SO THAT IT CAN EASILY BE INSTALLED ON THE LEFT OR RIGHT.
  - > OUR HANDY STARTER SET PERFECTLY ROUNDS OFF OUR PRODUCT RANGE.
- 

## VORTEILE

- > DAS EINPHASENSYSTEM IST DAS BEDIENERFREUNDLICHSTE PRODUKT AM MARKT.
  - > DIE EGLO TRACKSYSTEME ERMÖGLICHEN GEZIELTE INSZENIERUNG VON RÄUMEN, FLÄCHEN ODER GEGENSTÄNDEN.
  - > EGLO'S DEKORATIVE HIGHLIGHTS AUS DEM WOHNBEREICH WURDEN IN DAS EINPHASENSYSTEM INTEGRIERT. MITHILFE DES ADAPTERS KANN MAN EIGENE LEUCHTEN IN DAS SYSTEM EINSPEISEN.
  - > DAS SCHIENENSYSTEM LÄSST SICH MIT DEM LÄNGSVERBINDER KINDERLEICHT VERLÄNGERN.
  - > DER FLEXIBLE ECKVERBINDER MIT KUGELGELENK ERMÖGLICHT EINE EINFACHE LINKS- ODER RECHTSMONTAGE.
  - > DAS PRAKTISCHE EINSTEIGERSET RUNDET DIE PRODUKTPALETTE PERFEKT AB.
- 

## ADVANTAGES

- > LE SYSTÈME MONOPHASÉ EST LE PRODUIT LE PLUS CONVIVAL DU MARCHÉ.
- > LES SYSTÈMES DE RAILS EGLO PERMETTENT UNE MISE EN SCÈNE CIBLÉE DES PIÈCES, DES ESPACES OU DES OBJETS.
- > LES ÉLÉMENTS DÉCORATIFS D'EGLO POUR L'INTÉRIEUR ONT ÉTÉ INTÉGRÉS AU SYSTÈME MONOPHASÉ. GRÂCE À L'ADAPTATEUR, IL EST POSSIBLE D'INTÉGRER SES PROPRES LUMIÈRES AU SYSTÈME.
- > LE SYSTÈME DE RAILS PEUT ÊTRE FACILEMENT ÉTENDU GRÂCE AU CONNECTEUR LONGITUDINAL.
- > LE CONNECTEUR D'ANGLE FLEXIBLE AVEC ROTULE PERMET UN MONTAGE FACILE À GAUCHE OU À DROITE.
- > LE KIT DE DÉMARRAGE PRATIQUE COMPLÈTE PARFAITEMENT LA GAMME DE PRODUITS.





**99735**



**99734**

**99734, 99735**

These items come with a power feed and end cap included.

Diese Artikel enthalten als Zubehör Einspeisung und Endkappe.

Ces articles comprennent l'alimentation et l'embout comme accessoires.



**99737**

**99734 TB TRACK S**

accessory; aluminium, white  
Zubehör; Alu, weiss  
accessoire; aluminium, blanc

L 1000, B 35, H 20

**99735 TB TRACK L**

accessory; aluminium, white  
Zubehör; Alu, weiss  
accessoire; aluminium, blanc

L 2000, B 35, H 20

**99737 TB CONNECTOR**

accessory; plastic, white  
Zubehör; Kunststoff, weiss  
accessoire; plastique, blanc

L 81, B 35, H 23



9 002759 997342

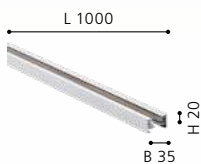

9 002759 997359



9 002759 997373





**99738**



**99736**



**99739**

**99738 TB MIDDLE FEEDER**

accessory; plastic, white  
Zubehör; Kunststoff, weiss  
accessoire; plastique, blanc

L 143, B 34, H 20

**99739 TB CORNER CONNECT**

accessory; plastic, white  
Zubehör; Kunststoff, weiss  
accessoire; plastique, blanc

L 276, B 34, H 20

**99736 TB ADAPTER**

accessory; plastic, white  
Zubehör; Kunststoff, weiss  
accessoire; plastique, blanc

L 81, B 39, H 71



9 002759 997380



9 002759 997397



9 002759 997366







**99743**



**99742**

**99742, 99743**

These items come with a power feed and end cap included.

Diese Artikel enthalten als Zubehör Einspeisung und Endkappe.

Ces articles contiennent une alimentation et un embout comme accessoires.



**99745**

### 99742 TB TRACK S

accessory; aluminium, black  
Zubehör; Alu, schwarz  
accessoire; aluminium, noir

L 1000, B 35, H 20

### 99743 TB TRACK L

accessory; aluminium, black  
Zubehör; Alu, schwarz  
accessoire; aluminium, noir

L 2000, B 35, H 20

### 99745 TB CONNECTOR

accessory; plastic, black  
Zubehör; Kunststoff, schwarz  
accessoire; plastique, noir

L 81, B 35, H 23

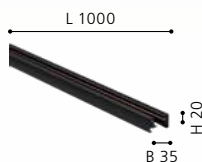



**99746**



**99744**



**99747**

**99746 TB MIDDLE FEEDER**

accessory; plastic, black  
Zubehör; Kunststoff, schwarz  
accessoire; plastique, noir

L 143, B 34, H 20

**99747 TB CORNER CONNECT**

accessory; plastic, black  
Zubehör; Kunststoff, schwarz  
accessoire; plastique, noir

L 276, B 34, H 20

**99744 TB ADAPTER**

accessory; plastic, black  
Zubehör; Kunststoff, schwarz  
accessoire; plastique, noir

L 81, B 39, H 71



9 002759 997465



L 143



9 002759 997472



L 276



9 002759 997441



L 81



**99761**



**99757**



**99753**

### 99761 TB NEWTOWN

pendant light; plastic, black / steel, black  
 Hängeleuchte; Kunststoff, schwarz / Stahl, schwarz  
 luminaire en suspension; plastique, noir / acier, noir

H 1100, Ø 160

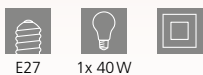

E27 1x 40W



9 002759 997618



### 99757 TB CASIBARE

pendant light; plastic, black / steel, black  
 Hängeleuchte; Kunststoff, schwarz / Stahl, schwarz  
 luminaire en suspension; plastique, noir / acier, noir

H 1100, Ø 150

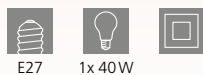

E27 1x 40W



9 002759 997571



### 99753 TB CORTENOVA

pendant light; plastic, white / steel, white  
 Hängeleuchte; Kunststoff, weiss / Stahl, weiss  
 luminaire en suspension; plastique, blanc / acier, blanc

H 1100, Ø 40



E27 1x 40W



9 002759 997533

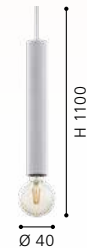



**99758**



**99754**



**99759**

**99753, 99754, 99757, 99758,  
99759, 99761**

Adapter included.

Inklusive Adapter.

Adapteur inclus.

### 99758 TB CORTENOVA

pendant light; plastic, black / steel, black  
Hängeleuchte; Kunststoff, schwarz / Stahl, schwarz  
luminaire en suspension; plastique, noir / acier, noir

H 1100, Ø 40



E27 1x 40W



9 002759 997588



### 99754 TB CORTADERAS

pendant light; plastic, white / steel, white  
Hängeleuchte; Kunststoff, weiss / Stahl, weiss  
luminaire en suspension; plastique, blanc / acier, blanc

H 1500, Ø 85

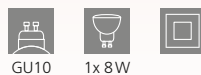

GU10 1x 8W



9 002759 997540



### 99759 TB CORTADERAS

pendant light; plastic, black / steel, black  
Hängeleuchte; Kunststoff, schwarz / Stahl, schwarz  
luminaire en suspension; plastique, noir / acier, noir

H 1500, Ø 85



GU10 1x 8W



9 002759 997595

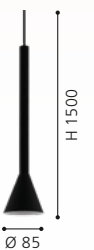



**99755**



**99749**



**99751**

**99749 TB SERAS**

spot; plastic, white / steel, white  
 Spot; Kunststoff, weiss / Stahl, weiss  
 spot; plastique, blanc / acier, blanc

H 165, Ø 85

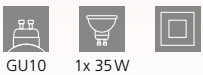

GU10 1x 35W



9 002759 997496



**99755 TB SERAS**

spot; plastic, black / steel, black  
 Spot; Kunststoff, schwarz / Stahl, schwarz  
 spot; plastique, noir / acier, noir

H 165, Ø 85

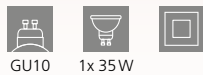

GU10 1x 35W



9 002759 997557



**99751 TB SPOTLIGHT**

spot; plastic, white / steel, white  
 Spot; Kunststoff, weiss / Stahl, weiss  
 spot; plastique, blanc / acier, blanc

L 80, B 85, H 150



GU10 1x 5W



9 002759 997519





### 99756 TB SPOTLIGHT

spot; plastic, black / steel, black  
Spot; Kunststoff, schwarz / Stahl, schwarz  
spot; plastique, noir / acier, noir

L 80, B 85, H 150



GU10 1x 5W



9 002759 997564



### 99762 TB SET

system; aluminium, plastic, white / steel, white  
System; Alu, Kunststoff, weiss / Stahl, weiss  
système; aluminium, plastique, blanc / acier, blanc

L 1000

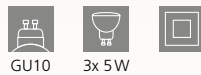

GU10 3x 5W



9 002759 997625



### 99763 TB SET

system; aluminium, plastic, black / steel, black  
System; Alu, Kunststoff, schwarz / Stahl, schwarz  
système; aluminium, plastique, noir / acier, noir

L 1000



GU10 3x 5W



9 002759 997632





# EGLO TRACK SYSTEMS

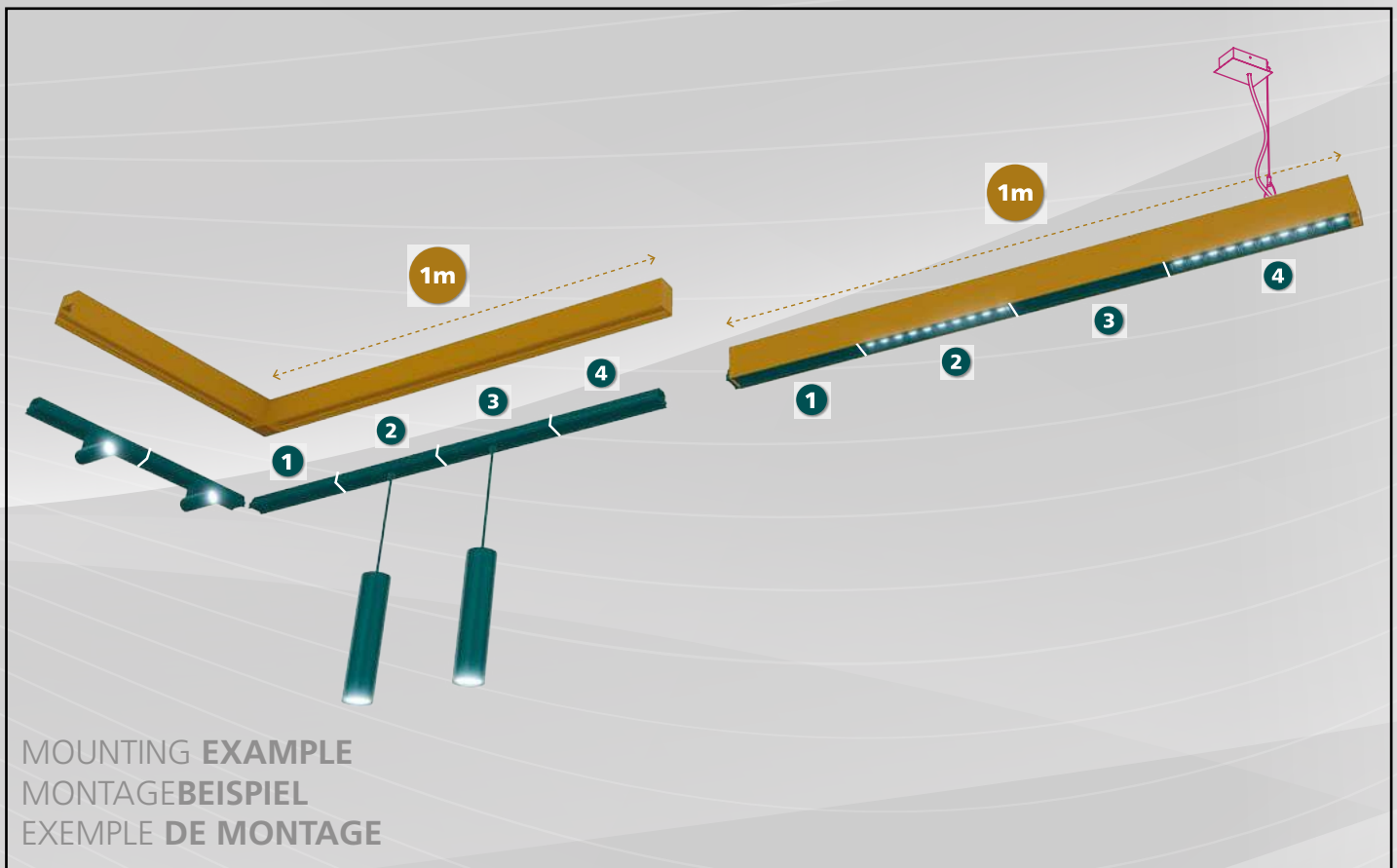

## PRO



MOUNTING EXAMPLE  
MONTAGEBEISPIEL  
EXEMPLE DE MONTAGE

## IN GENERAL/ ALLGEMEINES/ CARACTÉRISQUES GÉNÉRALES

- > the track has already installed a 24V driver and includes two endcovers and two connectors./ Die Schiene hat bereits einen 24V-Trafo installiert und enthält zwei Endabdeckungen und zwei Anschlüsse./Le rail est équipé d'un driver 24 V et inclut deux embouts et deux connecteurs.
- > mount it easily around corners with the connection cube./ Kann mit dem Verbindungswürfel leicht über das Eck montiert werden./ Peut être facilement monté dans les coins grâce au domino de raccordement.
- > can be fixed on the ceiling or optionally suspended./ Kann an der Decke oder optional abhängig befestigt werden. / Peut être fixé au plafond ou suspendu en option devenir.
- > all products in 3 different colors./ Alle Produkte in 3 verschiedenen Farben erhältlich: / Tous les produits sont disponibles en 3 coloris différents :

		
aluminum Aluminium aluminium	black Schwarz noir	white Weiß blanc

## EGLO TRACK PRO

1

You can fix as many rails as you want next to each other. Size: 1062,5 mm.

Sie können beliebig viele Tracks nebeneinander befestigen. Größe: 1062,5 mm.

Vous pouvez fixer autant de rails que vous le souhaitez les uns à côté des autres. Taille : 1 062,5 mm.

2

1 Track = max. 4 modules: choose out of 4 spotsolutions or use the end-to-end light insert for a complete illumination.

1 Track = max. 4 Module: Wählen Sie aus 4 Spot-Lösungen oder verwenden Sie den durchgängigen Leuchteinsatz für eine komplette Ausleuchtung.

1 rail = 4 modules maximum : choisissez parmi 4 solutions de spots ou utilisez un insert lumineux de bout en bout pour un éclairage complet.

3

Use the appropriate accessories to get the most out of the track PRO system.

Verwenden Sie das entsprechende Zubehör, um das Track PRO-System optimal zu nutzen.

Utilisez les accessoires appropriés pour tirer le meilleur parti de votre système de rail PRO.



## ADVANTAGES

- > WE'VE TAKEN THE FLEXIBLE LINEAR SYSTEM FROM THE TRADE SECTOR AND REDESIGNED IT FOR DIY CUSTOMERS.
  - > WE USE HIGH-QUALITY, ROBUST MATERIALS TO ENSURE A LONG SERVICE LIFE.
  - > ALL OUR RAILS INCLUDE A 24V DRIVER. EACH RAIL HAS ROOM FOR UP TO FOUR LIGHT INSERTS. THE LIGHT INSERTS ARE AVAILABLE IN TWO LENGTHS.
  - > THE SYSTEM CAN BE EXTENDED PRACTICALLY AND UNOBTRUSIVELY IN ALL DIRECTIONS USING A CONNECTING CUBE.
  - > INSTALL THE SYSTEM EITHER DIRECTLY ON THE CEILING OR SUSPENDED, AS PREFERRED.
  - > THE LIGHT INSERTS HAVE BEEN DESIGNED TO HARMONISE WITH THE SYSTEM FOR AN ELEGANT, TIMELESS EFFECT.
- 

## VORTEILE

- > DAS VIELSEITIGE LINEARSYSTEM AUS DEM PROFESSIONAL BEREICH - NUN FÜR DEN DIY MARKT KONZIPIERT.
  - > HOCHWERTIGE, ROBUSTE MATERIALIEN GARANTIEREN LANGLEBIGE PRODUKTE. ALLE SCHIENEN HABEN EINEN 24V TREIBER VERBAUT.
  - > JEDE SCHIENE BIETET PLATZ FÜR BIS ZU 4 LICHTEINSÄTZE. DIE LICHTEINSÄTZE SIND IN ZWEI VERSCHIEDENEN LÄNGEN ERHÄLTICH.
  - > EIN VERBINDUNGSWÜRFEL ERMÖGLICHT EINE DEZENTE UND UNAUFFÄLLIGE ERWEITERUNG IN ALLE RICHTUNGEN.
  - > DAS SYSTEM KANN ENTWEDER DIREKT AN DER DECKE ODER WAHLWEISE ABGEHÄNGENT MONTIERT WERDEN.
  - > DAS STIMMIGE DESIGN DER LICHTEINSÄTZE WIRKT ELEGANT UND ZEITLOS.
- 

## ADVANTAGES

- > LE SYSTÈME LINÉAIRE POLYVALENT DE LA GAMME PROFESSIONNELLE - DÉSORMAIS CONÇU POUR LE MARCHÉ DES PARTICULIERS.
- > DES MATÉRIAUX ROBUSTES DE HAUTE QUALITÉ GARANTISSENT LA LONGÉVITÉ DES PRODUITS.
- > TOUS LES RAILS SONT DOTÉS D'UN DRIVER 24 V. CHAQUE RAIL PEUT ACCUEILLIR JUSQU'À 4 INSERTS LUMINEUX. LES INSERTS LUMINEUX SONT DISPONIBLES EN DEUX LONGUEURS DIFFÉRENTES.
- > UN DOMINO DE RACCORDEMENT PERMET UNE EXTENSION DISCRÈTE DANS TOUTES LES DIRECTIONS.
- > LE SYSTÈME PEUT ÊTRE MONTÉ DIRECTEMENT AU PLAFOND OU SUSPENDU.
- > LES INSERTS LUMINEUX ONT UN DESIGN ÉLÉGANT ET INTEMPOREL.



**98821**



**98822**

### TP TRACK

24V driver included.

Inklusive 24V Treiber.

Pilote 24V inclus.



**98823**

### 98821 TP TRACK

system; aluminium, black  
System; Alu, schwarz  
système; aluminium, noir

L 1144, B 46, H 68



### 98822 TP TRACK

system; aluminium, white  
System; Alu, weiss  
système; aluminium, blanc

L 1144, B 46, H 68



### 98823 TP TRACK

system; aluminium, anodised aluminium  
System; Alu, alu eloxiert  
système; aluminium, aluminium anodisé

L 1144, B 46, H 68



9 002759 988210



L 1144



9 002759 988227



L 1144



9 002759 988234



L 1144



**98801**

### TP CUBE CONNECTOR

Accessories: 4 connectors and 3 end caps.

Zubehör: 4 Verbindungsstücke und 3 Endkappen.

Accessoires : 4 connecteurs et 3 embouts.



**98802**

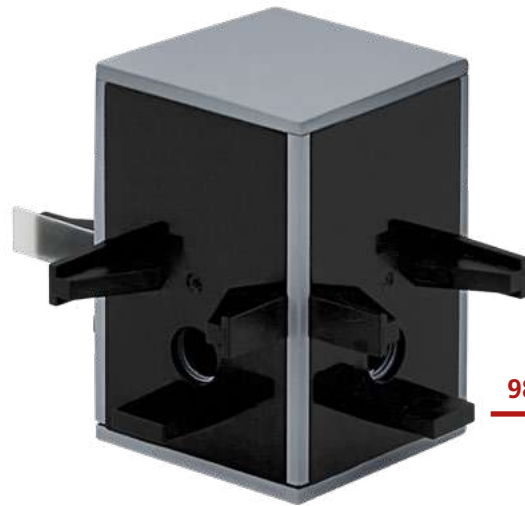

**98803**

#### 98801 TP CUBE CONNECTOR

accessory; plastic, aluminium, black  
Zubehör; Kunststoff, Alu, schwarz  
accessoire; plastique, aluminium, noir

L 61, B 76, H 68

#### 98802 TP CUBE CONNECTOR

accessory; plastic, aluminium, black, white  
Zubehör; Kunststoff, Alu, schwarz, weiss  
accessoire; plastique, aluminium, noir, blanc

L 61, B 76, H 68

#### 98803 TP CUBE CONNECTOR

accessory; plastic, aluminium, black, anodised aluminium  
Zubehör; Kunststoff, Alu, schwarz, alu eloxiert  
accessoire; plastique, aluminium, noir, aluminium anodisé

L 61, B 76, H 68



9 002759 988012

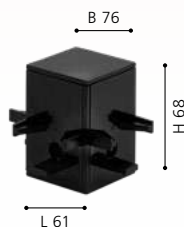

9 002759 988029

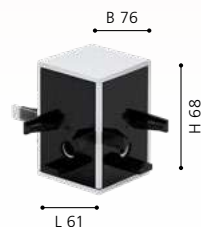

9 002759 988036

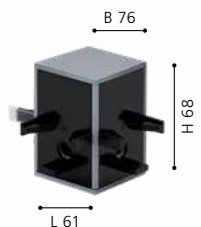



**98808**



**98809**



**98808 TP LIGHT INSERT S**

system; aluminium, aluminium / plastic, white  
 System; Alu, alu / Kunststoff, weiss  
 système; aluminium, aluminium / plastique, blanc

L 285, B 46, H 39



6,5W 780lm

**98809 TP LIGHT INSERT L**

system; aluminium, aluminium / plastic, white  
 System; Alu, alu / Kunststoff, weiss  
 système; aluminium, aluminium / plastique, blanc

L 1140, B 46, H 39



4x 6,5W 3120lm



9 002759 988081



9 002759 988098





98808







### 98824 TP BLIND COVER S

accessory; aluminium, black  
Zubehör; Alu, schwarz  
accessoire; aluminium, noir

L 142, B 44, H 14

### 98825 TP BLIND COVER S

accessory; aluminium, white  
Zubehör; Alu, weiss  
accessoire; aluminium, blanc

L 142, B 44, H 14

### 98826 TP BLIND COVER S

accessory; aluminium, anodised aluminium  
Zubehör; Alu, alu eloxiert  
accessoire; aluminium, aluminium anodisé

L 142, B 44, H 14





**98827**



**98828**



**98829**

### 98827 TP BLIND COVER L

accessory; aluminium, black  
Zubehör; Alu, schwarz  
accessoire; aluminium, noir

L 285, B 44, H 14

### 98828 TP BLIND COVER L

accessory; aluminium, white  
Zubehör; Alu, weiss  
accessoire; aluminium, blanc

L 285, B 44, H 14

### 98829 TP BLIND COVER L

accessory; aluminium, anodised aluminium  
Zubehör; Alu, alu eloxiert  
accessoire; aluminium, aluminium anodisé

L 285, B 44, H 14

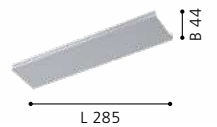



### 98804 TP SUSPENSION

accessory; steel, silver  
Zubehör; Stahl, silber  
accessoire; acier, argent

H 2035, Ø 15





**98806**



**98805**



**98807**

### 98805 TP CANOPY

accessory; steel, plastic, black  
Zubehör; Stahl, Kunststoff, schwarz  
accessoire; acier, plastique, noir

L 110, B 110, H 2025

### 98806 TP CANOPY

accessory; steel, plastic, white  
Zubehör; Stahl, Kunststoff, weiss  
accessoire; acier, plastique, blanc

L 110, B 110, H 2025

### 98807 TP CANOPY

accessory; steel, plastic, silver  
Zubehör; Stahl, Kunststoff, silber  
accessoire; acier, plastique, argent

L 110, B 110, H 2025



H 2025



H 2025



H 2025



98811

LED



98812

LED



98813

LED

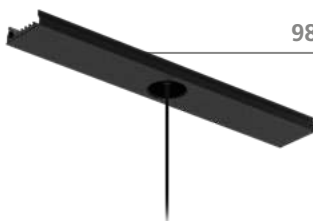

98811, 99912, 98813

Track insert included.

Inklusive Schieneneinsatz.

Insert de rail inclus.

### 98811 TP PENDANT LIGHT

pendant light; aluminium, plastic, black  
Hängeleuchte; Alu, Kunststoff, schwarz  
luminaire en suspension; aluminium, plastique, noir

L 285, B 44, H 2015, Ø 40



1x 9W 1200lm



9 002759 988111



Ø 40

### 98812 TP PENDANT LIGHT

pendant light; aluminium, plastic, white  
Hängeleuchte; Alu, Kunststoff, weiss  
luminaire en suspension; aluminium, plastique, blanc

L 285, B 44, H 2015, Ø 40



1x 9W 1200lm



9 002759 988128



Ø 40

### 98813 TP PENDANT LIGHT

pendant light; aluminium, plastic, anodised aluminium  
Hängeleuchte; Alu, Kunststoff, alu eloxiert  
luminaire en suspension; aluminium, plastique, aluminium  
anodisé

L 285, B 44, H 2015, Ø 40



1x 9W 1200lm



9 002759 988135



Ø 40



98811

LED





98814

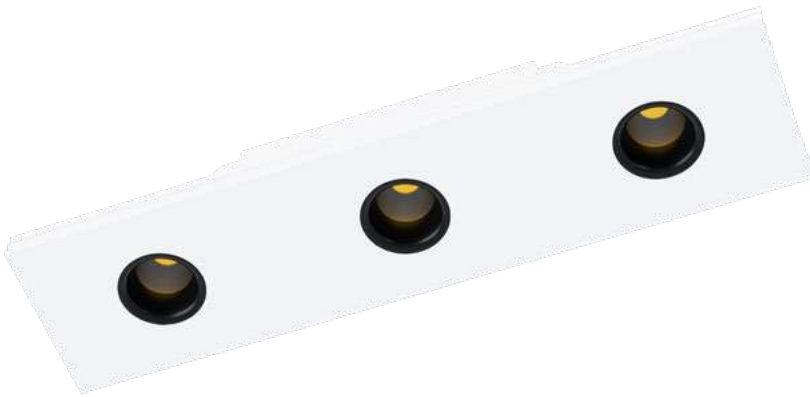

98815



98816



### 98814 TP DOWNLIGHT

system; aluminium, plastic, black  
System; Alu, Kunststoff, schwarz  
système; aluminium, plastique, noir

L 285, B 44, H 34



3x 3,5W 1530lm



9 002759 988142



### 98815 TP DOWNLIGHT

system; aluminium, plastic, white  
System; Alu, Kunststoff, weiss  
système; aluminium, plastique, blanc

L 285, B 44, H 34



3x 3,5W 1530lm



9 002759 988159

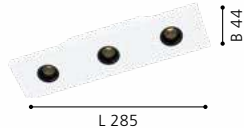

### 98816 TP DOWNLIGHT

system; aluminium, plastic, anodised aluminium  
System; Alu, Kunststoff, alu eloxiert  
système; aluminium, plastique, aluminium anodisé

L 285, B 44, H 34



3x 3,5W 1530lm



9 002759 988166





98817



98818



98819



**98817 TP SPOTLIGHT**

system; aluminium, plastic, black  
 System; Alu, Kunststoff, schwarz  
 système; aluminium, plastique, noir

L 285, B 44, H 95



1x 9W 1200lm



9 002759 988173



L 285

**98818 TP SPOTLIGHT**

system; aluminium, plastic, white  
 System; Alu, Kunststoff, weiss  
 système; aluminium, plastique, blanc

L 285, B 44, H 95



1x 9W 1200lm



9 002759 988180



L 285

**98819 TP SPOTLIGHT**

system; aluminium, plastic, anodised aluminium  
 System; Alu, Kunststoff, alu eloxiert  
 système; aluminium, plastique, aluminium anodisé

L 285, B 44, H 95



1x 9W 1200lm



9 002759 988197



L 285

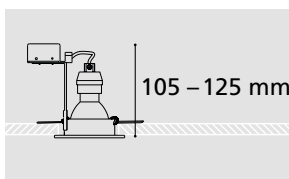

# RECESSED LUMINAIRES

## WITH BULBS

### ADVANTAGES

- > PROVEN TECHNOLOGY, CUSTOMIZED SOLUTIONS IN EVERY PRICE CATEGORY
- > DEPENDING ON THE SELECTED LAMPS APPROPRIATE FOR ILLUMINATING AREAS AND ROOMS OR FOR ACCENT LIGHTING
- > GREAT COLORS AND SHAPES
- > UP TO 80% POWER SAVINGS COMPARED TO INCANDESCENT LAMPS, EASY ON YOUR BUDGET AND THE ENVIRONMENT
- > LAMP REPLACEABLE FROM THE BOTTOM

---

### VORTEILE

- > BEWÄHRTE TECHNOLOGIE, INDIVIDUELLE LÖSUNGEN IN JEDER PREISKLASSE
- > JE NACH EINGESETZTEM LEUCHTMITTEL ZUR BELEUCHTUNG VON FLÄCHEN UND RÄUMEN ODER ZUR AKZENTBELEUCHTUNG
- > GROSSE FARBEN- UND FORMENVIELFALT
- > BIS ZU 80% STROMERSPARNIS GEGENÜBER GLÜHLAMPEN, SCHONT IHR BUDGET UND DIE UMWELT
- > LEUCHTMITTEL VON UNTEN TAUSCHBAR

---

### ADVANTAGES

- > UNE TECHNOLOGIE ÉPROUVÉE, SOLUTIONS INDIVIDUELLES DANS CHAQUE CATÉGORIE DE PRIX
- > SELON LES LAMPES CHOISIES APTE À ÉCLAIRER DES SURFACES ET DES CHAMBRES OU POUR L'ÉCLAIRAGE ACCENTUEL
- > COULEURS ET FORMES FANTASTIQUES
- > JUSQU'À 80% D'ÉCONOMIES D'ÉNERGIE PAR RAPPORT AUX LAMPES À INCANDESCENCE, RÉDUIT VOTRE BUDGET ET PROTÈGE L'ENVIRONNEMENT
- > LAMPE REMPLAÇABLE PAR LE BAS

# OVERVIEW

**5** year warranty  
Jahre Garantie  
ans de garantie  
anni di garanzia  
años de garantía  
años de garantía



SALUZZO  
p. 204



SALUZZO  
p. 204



AREITIO  
p. 206



AREITIO  
p. 206



PENETO  
p. 207



PENETO  
p. 207



PENETO  
p. 207



PENETO  
p. 208



PENETO  
p. 209



PENETO  
p. 209



PENETO  
p. 209



TEDO  
p. 210



TEDO  
p. 210



TEDO  
p. 210



TEDO  
p. 211



TEDO 1  
p. 212



TEDO 1  
p. 212



TEDO 1  
p. 213



**99062**



**99061**

DESIGN  
HIGHLIGHT  
DETAIL



**99062 SALUZZO**

recessed light; steel, white  
Einbauleuchte; Stahl, weiss  
luminaire encastrable; acier, blanc

H 3, Ø 90



**99061 SALUZZO**

recessed light; steel, black  
Einbauleuchte; Stahl, schwarz  
luminaire encastrable; acier, noir

H 3, Ø 90

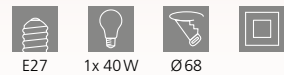

Ø 90



Ø 90



99061





**98639**

LED



**98637**

LED

**98639 AREITIO**

recessed light; aluminium, brushed aluminium  
 Einbauleuchte; Alu, alu-gebürstet  
 luminaire encastrable; aluminium, aluminium brossé

Ø 110



GU10



3x 5W



warm  
WHITE  
3x  
400lm



Ø 79



**98637 AREITIO**

recessed light; aluminium, brushed aluminium  
 Einbauleuchte; Alu, alu-gebürstet  
 luminaire encastrable; aluminium, aluminium brossé

L 95, B 95, ET 115



GU10



3x 5W



warm  
WHITE  
3x  
400lm



Ø 75

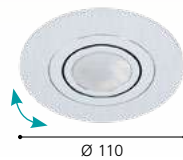



94235

LED



94237

LED



94236

LED

### 94235 PENETO

recessed light; steel, white  
 Einbauleuchte; Stahl, weiss  
 luminaire encastrable; acier, blanc

Ø 78, ET 115



### 94236 PENETO

recessed light; steel, chrome  
 Einbauleuchte; Stahl, chrom  
 luminaire encastrable; acier, chrome

Ø 78, ET 115



### 94237 PENETO

recessed light; steel, satin nickel  
 Einbauleuchte; Stahl, nickel-matt  
 luminaire encastrable; acier, nickel mat

Ø 78, ET 115

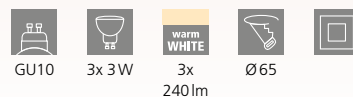



94239

LED



94239

LED

**94239 PENETO**

recessed light; steel, white  
 Einbauleuchte; Stahl, weiss  
 luminaire encastrable; acier, blanc

Ø 87, ET 115



GU10



1x 5W



warm  
 WHITE  
 1x  
 400lm



Ø70

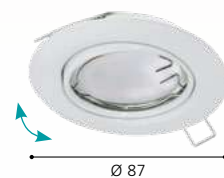



94406

LED



94408

LED



94407

LED

### 94406 PENETO

recessed light; steel, white  
 Einbauleuchte; Stahl, weiss  
 luminaire encastrable; acier, blanc

Ø 87, ET 115



### 94408 PENETO

recessed light; steel, satin nickel  
 Einbauleuchte; Stahl, nickel-matt  
 luminaire encastrable; acier, nickel mat

Ø 87, ET 115



### 94407 PENETO

recessed light; steel, chrome  
 Einbauleuchte; Stahl, chrom  
 luminaire encastrable; acier, chrome

Ø 87, ET 115



9 002759 944063



9 002759 944087

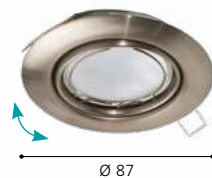

9 002759 944070





**31682**

LED



**31683**

LED



**31689**

LED

**31682 TEDO**

recessed light; cast aluminium, white  
 Einbauleuchte; Aluguss, weiss  
 luminaire encastrable; fonte d'aluminium, blanc

**31683 TEDO**

recessed light; cast aluminium, white  
 Einbauleuchte; Aluguss, weiss  
 luminaire encastrable; fonte d'aluminium, blanc

**31689 TEDO**

recessed light; cast aluminium, satin nickel  
 Einbauleuchte; Aluguss, nickel-matt  
 luminaire encastrable; fonte d'aluminium, nickel mat

Ø 80, ET 115



Ø 80, ET 115

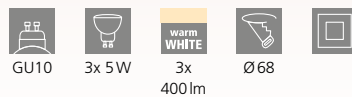

Ø 80, ET 115





31688

LED



31688

LED

### 31688 TEDO

recessed light; cast aluminium, satin nickel

Einbauleuchte; Aluguss, nickel-matt

luminaire encastrable; fonte d'aluminium, nickel mat

Ø 80, ET 115



GU10



1x 5W



warm  
WHITE  
1x  
400lm



Ø68



9 002759 316884



Ø 80





98641



98641



### 98641 TEDO 1

recessed light; cast aluminium, white  
Einbauleuchte; Aluguss, weiss  
luminaire encastrable; fonte d'aluminium, blanc

Ø 80, ET 115



GU10



1x 5W



warm  
WHITE  
1x  
400lm



Ø68



### 95357 TEDO 1

recessed light; cast aluminium, white  
Einbauleuchte; Aluguss, weiss  
luminaire encastrable; fonte d'aluminium, blanc

Ø 80, ET 115



GU10



3x 5W



warm  
WHITE  
3x  
400lm



Ø68



9 002759 986414



Ø 80



9 002759 953577



Ø 80



95357

LED



95359

LED

### 95359 TEDO 1

recessed light; cast aluminium, satin nickel

Einbauleuchte; Aluguss, nickel-matt

luminaire encastrable; fonte d'aluminium, nickel mat

Ø 80, ET 115



GU10



3x 5W



warm  
WHITE

3x

400lm



Ø68



9 002759 953591



Ø 80

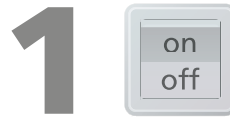

### DIMMING WITHOUT A DIMMER?

There's no need for a dimmer anymore, and no need to spend money on an expensive modern LED-capable one.

The luminaire automatically switches to the next dimming level when it is switched off and on again within 3 seconds. If the luminaire stays off for more than 3 seconds, the next activation will automatically return to full lighting. You don't need to switch through all levels the next day.

#### Note

Our step dimming illuminants are only dimmable via the on/off switch. Operation with a conventional dimmer is not intended and may cause permanent damage to the electronics. The illuminants are therefore marked as "not dimmable" according to European regulations.

### DIMMEN OHNE DIMMER?

Kein Dimmer mehr notwendig – Sie ersparen sich somit hohe Anschaffungskosten für einen modernen LED-fähigen Dimmer.

Wird die Leuchte innerhalb von 3 Sekunden aus- und wieder eingeschaltet, wechselt es automatisch in die nächste Dimmstufe. Bleibt die Leuchte länger als 3 Sekunden ausgeschaltet, stehen Ihnen beim nächsten Einschalten automatisch wieder 100 % Leuchtkraft zur Verfügung – Sie ersparen sich also das mühsame Durchschalten am nächsten Tag.

#### Hinweis

Unsere Stepdimming-Leuchtmittel sind nur über Ein-/Ausschalter dimmbar – der Betrieb mit konventionellen Dimmern ist nicht vorgesehen und könnte die Elektronik dauerhaft beschädigen. Die Leuchtmittel werden daher gemäß europäischer Vorschriften als „nicht dimmbar“ gekennzeichnet.

### GRADUER SANS GRADUATEUR ?

Aucun graduateur n'est nécessaire – Vous vous épargnez ainsi les coûts d'acquisition élevés pour un graduateur DEL moderne.

Lorsque le luminaire est éteint, puis rallumé en l'espace de 3 secondes, il passe automatiquement au prochain niveau de graduation. Lorsque le luminaire reste éteint plus de 3 secondes, vous aurez à nouveau automatiquement 100 % de la force lumineuse lors du prochain allumage – Vous vous épargnez alors la commutation fatigante le lendemain.

#### Remarque

Nos ampoules à graduation par niveau sont graduable uniquement par l'interrupteur marche / arrêt – le service avec un graduateur conventionnel n'est pas prévu et pourrait endommager l'électronique à long terme. Les ampoules sont alors marquées par « non graduable », selon les réglementations européenne.

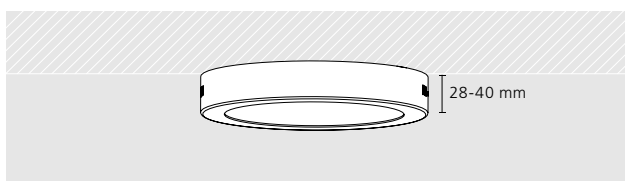

# SURFACE LUMINAIRES

## FUEVA

### ADVANTAGES

- > SLIM DESIGN WITH LOW SURFACE HEIGHT (28 TO 40 MM)
- > UNIFORM DISTRIBUTION OF INDIRECT LIGHT - IDEAL FOR ILLUMINATING SPACES AND SURFACES
- > LOW TEMPERATURE ENHANCES SAFETY
- > UP TO 80% POWER SAVINGS COMPARED TO INCANDESCENT LAMPS, EASY ON YOUR BUDGET AND THE ENVIRONMENT

---

### VORTEILE

- > SCHLANKE BAUFORM MIT GERINGER AUFBAUHÖHE (28 BIS 40 MM)
- > HOMOGENES, INDIREKTES LICHT - IDEAL ZUR BELEUCHTUNG VON RÄUMEN UND FLÄCHEN
- > GERINGE WÄRMEENTWICKLUNG SORGT FÜR MEHR SICHERHEIT
- > BIS ZU 80% STROMERSPARNIS GEGENÜBER GLÜHLAMPEN, SCHONT IHR BUDGET UND DIE UMWELT

















---

### ADVANTAGES

- > CONCEPTION MINCE AVEC LA HAUTEUR DE SAILIE MINIMALE (DE 28 À 40 MM)
- > LA DISTRIBUTION UNIFORME DE LA LUMIÈRE INDIRECTE - IDÉAL POUR LES ESPACES ET LES SURFACES ÉCLAIRANTES
- > FAIBLE CHALEUR AMÉLIORE LA SÉCURITÉ
- > JUSQU'À 80% D'ÉCONOMIES D'ÉNERGIE PAR RAPPORT AUX LAMPES À INCANDESCENCE, RÉDUIT VOTRE BUDGET ET PROTÈGE L'ENVIRONNEMENT

# OVERVIEW

**5** year warranty  
 Jahre Garantie  
 ans de garantie  
 anni di garanzia  
 años de garantía  
 años de garantía

							
FUEVA 5 p. 217	FUEVA 5 p. 217	FUEVA 5 p. 217	FUEVA 5 p. 218	FUEVA 5 p. 218	FUEVA 5 p. 218	FUEVA 5 p. 219	FUEVA 5 p. 219
							
FUEVA 5 p. 219	FUEVA 5 p. 220	FUEVA 5 p. 220	FUEVA 5 p. 220	FUEVA 5 p. 221	FUEVA 5 p. 221	FUEVA 5 p. 221	FUEVA 5 p. 222
							
FUEVA 5 p. 222	FUEVA 5 p. 222	FUEVA 5 p. 224	FUEVA 5 p. 224	FUEVA 5 p. 224	FUEVA 5 p. 225	FUEVA 5 p. 225	FUEVA 5 p. 225
							
FUEVA 5 p. 226	FUEVA 5 p. 226	FUEVA 5 p. 226	FUEVA 5 p. 228	FUEVA 5 p. 228	FUEVA 5 p. 228	FUEVA 5 p. 229	FUEVA 5 p. 229
							
FUEVA 5 p. 229	FUEVA 5 p. 230	FUEVA 5 p. 230	FUEVA 5 p. 230	FUEVA 5 p. 232	FUEVA 5 p. 232	FUEVA 5 p. 232	FUEVA 5 p. 233
							
FUEVA 5 p. 234	FUEVA 5 p. 234	FUEVA 5 p. 234	FUEVA 5 p. 236	FUEVA 5 p. 236	FUEVA 5 p. 236	FUEVA 5 p. 238	FUEVA 5 p. 239
							
FUEVA 5 p. 239	FUEVA 5 p. 239	FUEVA 1 p. 240	FUEVA 1 p. 240	FUEVA 1 p. 240	FUEVA 1 p. 241	FUEVA 1 p. 241	FUEVA 1 p. 241
							
FUEVA 1 p. 242	FUEVA 1 p. 242	FUEVA 1 p. 242	FUEVA 1 p. 243				

# FUEVA 5



## FEATURES

Quick Connector  
Schnellverbinder  
Connecteur rapide

FLICKER FREE  
FLICKER FREI  
FLICKER FREE

## DESIGN

Flat design from originally 40 mm  
high to **28** mm high  
Flaches Design von ursprünglich 40 mm  
Höhe auf **28** mm Höhe  
Design plat de 40 mm de haut à  
**28** mm de haut

Narrow frame from 21 mm to **15** mm  
Schmäler Rahmen von 21 mm auf **15** mm  
Cadre étroit de 21 mm vers **15** mm

Modern appearance  
Moderneres Erscheinungsbild  
Apparence plus moderne



99215



99217



99216



### 99215 FUEVA 5

surface-mounted light; steel, white / plastic, white  
Aufbauleuchte; Stahl, weiss / Kunststoff, weiss  
luminaire en saillie; acier, blanc / plastique, blanc

H 28, Ø 160



10,5W 1200lm

### 99216 FUEVA 5

surface-mounted light; steel, white / plastic, white  
Aufbauleuchte; Stahl, weiss / Kunststoff, weiss  
luminaire en saillie; acier, blanc / plastique, blanc

H 28, Ø 210



16,5W 1800lm

### 99217 FUEVA 5

surface-mounted light; steel, white / plastic, white  
Aufbauleuchte; Stahl, weiss / Kunststoff, weiss  
luminaire en saillie; acier, blanc / plastique, blanc

H 28, Ø 285



20W 2300lm



9 002759 992156



Ø 160



9 002759 992163



Ø 210



9 002759 992170



Ø 285





99218



99221



99219



### 99218 FUEVA 5

surface-mounted light; steel, satin nickel / plastic, white  
Aufbauleuchte; Stahl, nickel-matt / Kunststoff, weiss  
luminaire en saillie; acier, nickel mat / plastique, blanc

H 28, Ø 160



10,5W 1200lm

### 99219 FUEVA 5

surface-mounted light; steel, satin nickel / plastic, white  
Aufbauleuchte; Stahl, nickel-matt / Kunststoff, weiss  
luminaire en saillie; acier, nickel mat / plastique, blanc

H 28, Ø 210



16,5W 1800lm

### 99221 FUEVA 5

surface-mounted light; steel, satin nickel / plastic, white  
Aufbauleuchte; Stahl, nickel-matt / Kunststoff, weiss  
luminaire en saillie; acier, nickel mat / plastique, blanc

H 28, Ø 285



20W 2300lm



9 002759 992187



Ø 160



9 002759 992194



Ø 210



9 002759 992217



Ø 285



99222



99224



99223



### 99222 FUEVA 5

surface-mounted light; steel, black / plastic, white  
Aufbauleuchte; Stahl, schwarz / Kunststoff, weiss  
luminaire en saillie; acier, noir / plastique, blanc

H 28, Ø 160



10,5W 1200lm

### 99223 FUEVA 5

surface-mounted light; steel, black / plastic, white  
Aufbauleuchte; Stahl, schwarz / Kunststoff, weiss  
luminaire en saillie; acier, noir / plastique, blanc

H 28, Ø 210



16,5W 1800lm

### 99224 FUEVA 5

surface-mounted light; steel, black / plastic, white  
Aufbauleuchte; Stahl, schwarz / Kunststoff, weiss  
luminaire en saillie; acier, noir / plastique, blanc

H 28, Ø 285



20W 2300lm



9 002759 992224



Ø 160



9 002759 992231



Ø 210



9 002759 992248



Ø 285



99225



99227



99226



### 99225 FUEVA 5

surface-mounted light; steel, white / plastic, white  
Aufbauleuchte; Stahl, weiss / Kunststoff, weiss  
luminaire en saillie; acier, blanc / plastique, blanc

H 28, Ø 160



10,5W 1350lm

### 99226 FUEVA 5

surface-mounted light; steel, white / plastic, white  
Aufbauleuchte; Stahl, weiss / Kunststoff, weiss  
luminaire en saillie; acier, blanc / plastique, blanc

H 28, Ø 210



16,5W 2000lm

### 99227 FUEVA 5

surface-mounted light; steel, white / plastic, white  
Aufbauleuchte; Stahl, weiss / Kunststoff, weiss  
luminaire en saillie; acier, blanc / plastique, blanc

H 28, Ø 285



20W 2500lm



9 002759 992255



Ø 160



9 002759 992262



Ø 210



9 002759 992279



Ø 285





99228



99232



99229



### 99228 FUEVA 5

surface-mounted light; steel, satin nickel / plastic, white  
Aufbauleuchte; Stahl, nickel-matt / Kunststoff, weiss  
luminaire en saillie; acier, nickel mat / plastique, blanc

H 28, Ø 160



10,5W 1350lm

### 99229 FUEVA 5

surface-mounted light; steel, satin nickel / plastic, white  
Aufbauleuchte; Stahl, nickel-matt / Kunststoff, weiss  
luminaire en saillie; acier, nickel mat / plastique, blanc

H 28, Ø 210



16,5W 2000lm

### 99232 FUEVA 5

surface-mounted light; steel, satin nickel / plastic, white  
Aufbauleuchte; Stahl, nickel-matt / Kunststoff, weiss  
luminaire en saillie; acier, nickel mat / plastique, blanc

H 28, Ø 285



20W 2500lm



9 002759 992286



Ø 160



9 002759 992293



Ø 210



9 002759 992323



Ø 285



99233



99235



99234



### 99233 FUEVA 5

surface-mounted light; steel, black / plastic, white  
Aufbauleuchte; Stahl, schwarz / Kunststoff, weiss  
luminaire en saillie; acier, noir / plastique, blanc

H 28, Ø 160



10,5W 1350lm

### 99234 FUEVA 5

surface-mounted light; steel, black / plastic, white  
Aufbauleuchte; Stahl, schwarz / Kunststoff, weiss  
luminaire en saillie; acier, noir / plastique, blanc

H 28, Ø 210



16,5W 2000lm

### 99235 FUEVA 5

surface-mounted light; steel, black / plastic, white  
Aufbauleuchte; Stahl, schwarz / Kunststoff, weiss  
luminaire en saillie; acier, noir / plastique, blanc

H 28, Ø 285



20W 2500lm



9 002759 992330



Ø 160



9 002759 992347



Ø 210



9 002759 992354



Ø 285



99235







99236

LED



99238

LED



99237

LED

### 99236 FUEVA 5

surface-mounted light; steel, white / plastic, white  
Aufbauleuchte; Stahl, weiss / Kunststoff, weiss  
luminaire en saillie; acier, blanc / plastique, blanc

L 160, B 160, H 28



10,5W 1200lm

### 99237 FUEVA 5

surface-mounted light; steel, white / plastic, white  
Aufbauleuchte; Stahl, weiss / Kunststoff, weiss  
luminaire en saillie; acier, blanc / plastique, blanc

L 210, B 210, H 28



16,5W 1800lm

### 99238 FUEVA 5

surface-mounted light; steel, white / plastic, white  
Aufbauleuchte; Stahl, weiss / Kunststoff, weiss  
luminaire en saillie; acier, blanc / plastique, blanc

L 285, B 285, H 28



20W 2300lm



9 002759 992361



B 160

L 160



9 002759 992378



B 210

L 210



9 002759 992385



B 285

L 285



99239



99242



99241



### 99239 FUEVA 5

surface-mounted light; steel, satin nickel / plastic, white  
Aufbauleuchte; Stahl, nickel-matt / Kunststoff, weiss  
luminaire en saillie; acier, nickel mat / plastique, blanc

L 160, B 160, H 28



10,5W 1200lm

### 99241 FUEVA 5

surface-mounted light; steel, satin nickel / plastic, white  
Aufbauleuchte; Stahl, nickel-matt / Kunststoff, weiss  
luminaire en saillie; acier, nickel mat / plastique, blanc

L 210, B 210, H 28



16,5W 1800lm

### 99242 FUEVA 5

surface-mounted light; steel, satin nickel / plastic, white  
Aufbauleuchte; Stahl, nickel-matt / Kunststoff, weiss  
luminaire en saillie; acier, nickel mat / plastique, blanc

L 285, B 285, H 28



20W 2300lm



9 002759 992392

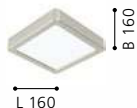

L 160



9 002759 992415

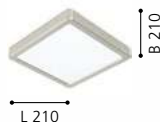

L 210



9 002759 992422



L 285



99243

LED



99245

LED



99244

LED

### 99243 FUEVA 5

surface-mounted light; steel, black / plastic, white  
 Aufbauleuchte; Stahl, schwarz / Kunststoff, weiss  
 luminaire en saillie; acier, noir / plastique, blanc

L 160, B 160, H 28



10,5W 1200lm

### 99244 FUEVA 5

surface-mounted light; steel, black / plastic, white  
 Aufbauleuchte; Stahl, schwarz / Kunststoff, weiss  
 luminaire en saillie; acier, noir / plastique, blanc

L 210, B 210, H 28



16,5W 1800lm

### 99245 FUEVA 5

surface-mounted light; steel, black / plastic, white  
 Aufbauleuchte; Stahl, schwarz / Kunststoff, weiss  
 luminaire en saillie; acier, noir / plastique, blanc

L 285, B 285, H 28



20W 2300lm



9 002759 992439



L 160



9 002759 992446



L 210



9 002759 992453



L 285



99245

LED





99246



99248



99247



### 99246 FUEVA 5

surface-mounted light; steel, white / plastic, white  
Aufbauleuchte; Stahl, weiss / Kunststoff, weiss  
luminaire en saillie; acier, blanc / plastique, blanc

L 160, B 160, H 28



### 99247 FUEVA 5

surface-mounted light; steel, white / plastic, white  
Aufbauleuchte; Stahl, weiss / Kunststoff, weiss  
luminaire en saillie; acier, blanc / plastique, blanc

L 210, B 210, H 28



### 99248 FUEVA 5

surface-mounted light; steel, white / plastic, white  
Aufbauleuchte; Stahl, weiss / Kunststoff, weiss  
luminaire en saillie; acier, blanc / plastique, blanc

L 285, B 285, H 28



9 002759 992460

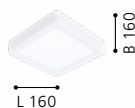

9 002759 992477



9 002759 992484





99252

LED



99254

LED



99253

LED

### 99252 FUEVA 5

surface-mounted light; steel, satin nickel / plastic, white  
Aufbauleuchte; Stahl, nickel-matt / Kunststoff, weiss  
luminaire en saillie; acier, nickel mat / plastique, blanc

L 160, B 160, H 28



10,5W 1350lm

### 99253 FUEVA 5

surface-mounted light; steel, satin nickel / plastic, white  
Aufbauleuchte; Stahl, nickel-matt / Kunststoff, weiss  
luminaire en saillie; acier, nickel mat / plastique, blanc

L 210, B 210, H 28



16,5W 2000lm

### 99254 FUEVA 5

surface-mounted light; steel, satin nickel / plastic, white  
Aufbauleuchte; Stahl, nickel-matt / Kunststoff, weiss  
luminaire en saillie; acier, nickel mat / plastique, blanc

L 285, B 285, H 28



20W 2500lm



9 002759 992521



9 002759 992538



9 002759 992545







99255



99257



99256



### 99255 FUEVA 5

surface-mounted light; steel, black / plastic, white  
Aufbauleuchte; Stahl, schwarz / Kunststoff, weiss  
luminaire en saillie; acier, noir / plastique, blanc

L 160, B 160, H 28



10,5W 1350lm

### 99256 FUEVA 5

surface-mounted light; steel, black / plastic, white  
Aufbauleuchte; Stahl, schwarz / Kunststoff, weiss  
luminaire en saillie; acier, noir / plastique, blanc

L 210, B 210, H 28



16,5W 2000lm

### 99257 FUEVA 5

surface-mounted light; steel, black / plastic, white  
Aufbauleuchte; Stahl, schwarz / Kunststoff, weiss  
luminaire en saillie; acier, noir / plastique, blanc

L 285, B 285, H 28



20W 2500lm



9 002759 992552

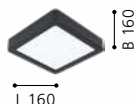

9 002759 992569



9 002759 992576





99256

LED





99258



99263



99259



### 99258 FUEVA 5

surface-mounted light; steel, white / plastic, white  
Aufbauleuchte; Stahl, weiss / Kunststoff, weiss  
luminaire en saillie; acier, blanc / plastique, blanc

H 28, Ø 210



16,5W 1800lm

### 99259 FUEVA 5

surface-mounted light; steel, white / plastic, white  
Aufbauleuchte; Stahl, weiss / Kunststoff, weiss  
luminaire en saillie; acier, blanc / plastique, blanc

H 28, Ø 285

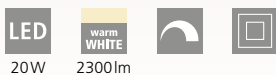

20W 2300lm

### 99263 FUEVA 5

surface-mounted light; steel, black / plastic, white  
Aufbauleuchte; Stahl, schwarz / Kunststoff, weiss  
luminaire en saillie; acier, noir / plastique, blanc

H 28, Ø 210



16,5W 1800lm



9 002759 992583



Ø 210



9 002759 992590



Ø 285



9 002759 992637



Ø 210



99264



99263



### 99264 FUEVA 5

surface-mounted light; steel, black / plastic, white  
Aufbauleuchte; Stahl, schwarz / Kunststoff, weiss  
luminaire en saillie; acier, noir / plastique, blanc

H 28, Ø 285

LED

20W

warm  
WHITE

2300lm



9 002759 992644



Ø 285



**99265**



IP44



**99267**



IP44

### 99265 FUEVA 5

surface-mounted light; steel, white / plastic, white  
 Aufbauleuchte; Stahl, weiss / Kunststoff, weiss  
 luminaire en saillie; acier, blanc / plastique, blanc

H 28, Ø 285



### 99267 FUEVA 5

surface-mounted light; steel, black / plastic, white  
 Aufbauleuchte; Stahl, schwarz / Kunststoff, weiss  
 luminaire en saillie; acier, noir / plastique, blanc

H 28, Ø 285



### 99266 FUEVA 5

surface-mounted light; steel, chrome / plastic, white  
 Aufbauleuchte; Stahl, chrom / Kunststoff, weiss  
 luminaire en saillie; acier, chrome / plastique, blanc

H 28, Ø 285



9 002759 992651



Ø 285



9 002759 992675



Ø 285



9 002759 992668



Ø 285





**99266**



IP44



**99266**



IP44





99268



IP44



99271



IP44

### 99268 FUEVA 5

surface-mounted light; steel, white / plastic, white  
 Aufbauleuchte; Stahl, weiss / Kunststoff, weiss  
 luminaire en saillie; acier, blanc / plastique, blanc

L 285, B 285, H 30



9 002759 992682



L 285

### 99271 FUEVA 5

surface-mounted light; steel, black / plastic, white  
 Aufbauleuchte; Stahl, schwarz / Kunststoff, weiss  
 luminaire en saillie; acier, noir / plastique, blanc

L 285, B 285, H 30



9 002759 992712



L 285

### 99269 FUEVA 5

surface-mounted light; steel, chrome / plastic, white  
 Aufbauleuchte; Stahl, chrom / Kunststoff, weiss  
 luminaire en saillie; acier, chrome / plastique, blanc

L 285, B 285, H 30



9 002759 992699



L 285



**99269**



IP44



**99269**



IP44



30892

LED



IP44



30892

LED



IP44



30891

LED



IP44

### 30892 FUEVA 5

surface-mounted light; steel, chrome / plastic, white  
Aufbauleuchte; Stahl, chrom / Kunststoff, weiss  
luminaire en saillie; acier, chrome / plastique, blanc

H 28, Ø 285

LED

20W

neutral  
WHITE

2200lm



IP44



9 002759 308926



Ø 285

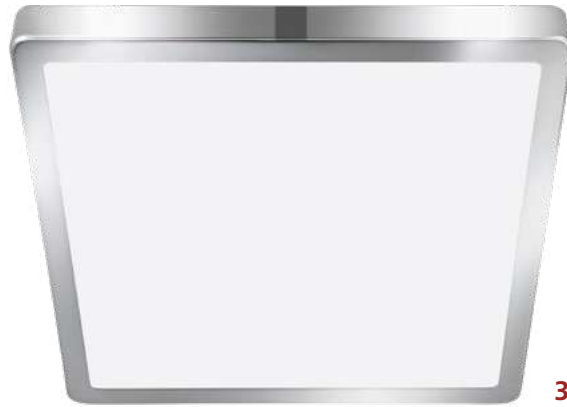

30894



IP44



30893



IP44

### 30891 FUEVA 5

surface-mounted light; steel, white / plastic, white  
 Aufbauleuchte; Stahl, weiss / Kunststoff, weiss  
 luminaire en saillie; acier, blanc / plastique, blanc

H 28, Ø 285



9 002759 308919



Ø 285

### 30894 FUEVA 5

surface-mounted light; steel, chrome / plastic, white  
 Aufbauleuchte; Stahl, chrom / Kunststoff, weiss  
 luminaire en saillie; acier, chrome / plastique, blanc

L 285, B 285, H 30



9 002759 308940



L 285

B 285

### 30893 FUEVA 5

surface-mounted light; steel, white / plastic, white  
 Aufbauleuchte; Stahl, weiss / Kunststoff, weiss  
 luminaire en saillie; acier, blanc / plastique, blanc

L 285, B 285, H 30



9 002759 308933



L 285

B 285



97262

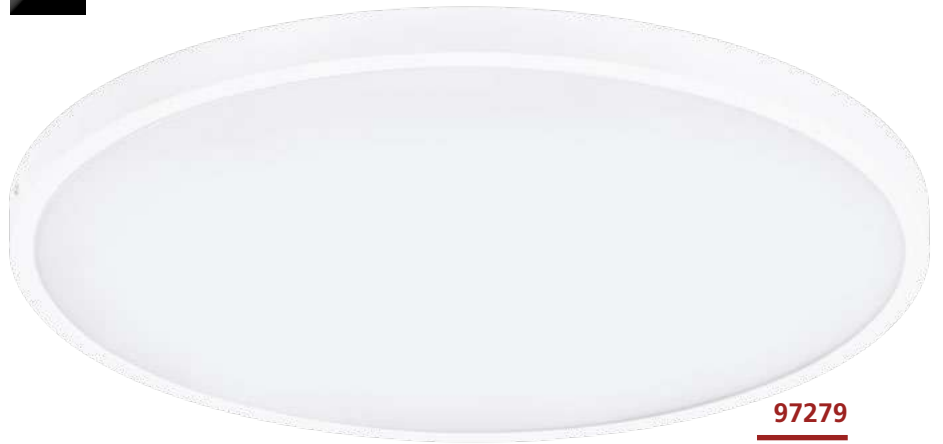

97279



97271



### 97262 FUEVA 1

surface-mounted light; aluminium, white / plastic, white  
Aufbauleuchte; Alu, weiss / Kunststoff, weiss  
luminaire en saillie; aluminium, blanc / plastique, blanc

H 30, Ø 400



### 97271 FUEVA 1

surface-mounted light; aluminium, white / plastic, white  
Aufbauleuchte; Alu, weiss / Kunststoff, weiss  
luminaire en saillie; aluminium, blanc / plastique, blanc

H 30, Ø 500



### 97279 FUEVA 1

surface-mounted light; aluminium, white / plastic, white  
Aufbauleuchte; Alu, weiss / Kunststoff, weiss  
luminaire en saillie; aluminium, blanc / plastique, blanc

H 30, Ø 600



9 002759 972622



Ø 400



9 002759 972714



Ø 500



9 002759 972790



Ø 600



97263



97266



97267



### 97266 FUEVA 1

surface-mounted light; aluminium, white / plastic, white  
Aufbauleuchte; Alu, weiss / Kunststoff, weiss  
luminaire en saillie; aluminium, blanc / plastique, blanc

H 30, Ø 400



### 97263 FUEVA 1

surface-mounted light; aluminium, silver / plastic, white  
Aufbauleuchte; Alu, silber / Kunststoff, weiss  
luminaire en saillie; aluminium, argent / plastique, blanc

H 30, Ø 400



### 97267 FUEVA 1

surface-mounted light; aluminium, silver / plastic, white  
Aufbauleuchte; Alu, silber / Kunststoff, weiss  
luminaire en saillie; aluminium, argent / plastique, blanc

H 30, Ø 400







97269

LED



97265

LED

### 97265 FUEVA 1

surface-mounted light; aluminium, silver / plastic, white  
 Aufbauleuchte; Alu, silber / Kunststoff, weiss  
 luminaire en saillie; aluminium, argent / plastique, blanc

L 400, B 400, H 30



### 97269 FUEVA 1

surface-mounted light; aluminium, silver / plastic, white  
 Aufbauleuchte; Alu, silber / Kunststoff, weiss  
 luminaire en saillie; aluminium, argent / plastique, blanc

L 400, B 400, H 30



### 97264 FUEVA 1

surface-mounted light; aluminium, white / plastic, white  
 Aufbauleuchte; Alu, weiss / Kunststoff, weiss  
 luminaire en saillie; aluminium, blanc / plastique, blanc

L 400, B 400, H 30



9 002759 972653



9 002759 972691



9 002759 972646





97268



97264



97268



### 97268 FUEVA 1

surface-mounted light; aluminium, white / plastic, white  
Aufbauleuchte; Alu, weiss / Kunststoff, weiss  
luminaire en saillie; aluminium, blanc / plastique, blanc

L 400, B 400, H 30



25W



2500lm



9 002759 972684

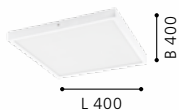



# SURFACE LUMINAIRES

## DECORATIVE

### ADVANTAGES

- > UNIFORM DISTRIBUTION OF INDIRECT LIGHT - IDEAL FOR ILLUMINATING SPACES AND SURFACES
  - > LOW TEMPERATURE ENHANCES SAFETY
  - > UP TO 80% POWER SAVINGS COMPARED TO INCANDESCENT LAMPS, EASY ON YOUR BUDGET AND THE ENVIRONMENT
- 

### VORTEILE

- > HOMOGENES, INDIREKTES LICHT – IDEAL ZUR BELEUCHTUNG VON RÄUMEN UND FLÄCHEN
  - > GERINGE WÄRMEENTWICKLUNG SORGT FÜR MEHR SICHERHEIT
  - > BIS ZU 80% STROMERSPARNIS GEGENÜBER GLÜHLAMPEN, SCHONT IHR BUDGET UND DIE UMWELT
- 

### ADVANTAGES

- > LA DISTRIBUTION UNIFORME DE LA LUMIÈRE INDIRECTE - IDÉAL POUR LES ESPACES ET LES SURFACES ÉCLAIRANTES
- > FAIBLE CHALEUR AMÉLIORE LA SÉCURITÉ
- > JUSQU'À 80% D'ÉCONOMIES D'ÉNERGIE PAR RAPPORT AUX LAMPES À INCANDESCENCE, RÉDUIT VOTRE BUDGET ET PROTÈGE L'ENVIRONNEMENT

# OVERVIEW

**5** year warranty  
Jahre Garantie  
ans de garantie  
anni di garanzia  
años de garantía  
años de garantía



CRESPILLO  
p. 246



CRESPILLO  
p. 246



CRESPILLO  
p. 246



CRESPILLO  
p. 247



POLASSO  
p. 248



POLASSO  
p. 248



POLASSO  
p. 248



POLASSO  
p. 249



POLASSO  
p. 250



POLASSO  
p. 250



POLASSO  
p. 250



FERREROS  
p. 252



FERREROS  
p. 252



FERREROS  
p. 252



LOKE 1  
p. 253



SALUZZO  
p. 254



SALUZZO  
p. 254



GRIMASOLA  
p. 256



GRIMASOLA  
p. 256



GRIMASOLA  
p. 256



GRIMASOLA  
p. 257





DESIGN  
HIGHLIGHT  
DETAIL



99338

LED



99337

LED



99726

LED

### 99337 CRESPILLO

surface-mounted light; plastic, steel, white / plastic, white  
Aufbauleuchte; Kunststoff, Stahl, weiss / Kunststoff, weiss  
luminaire en saillie; plastique, acier, blanc / plastique, blanc

H 45, Ø 240



16W 1600lm

### 99338 CRESPILLO

surface-mounted light; plastic, steel, white / plastic, white  
Aufbauleuchte; Kunststoff, Stahl, weiss / Kunststoff, weiss  
luminaire en saillie; plastique, acier, blanc / plastique, blanc

H 45, Ø 315



18W 2000lm

### 99726 CRESPILLO

surface-mounted light; plastic, white / plastic, white  
Aufbauleuchte; Kunststoff, weiss / Kunststoff, weiss  
luminaire en saillie; plastique, blanc / plastique, blanc

H 65, Ø 380



21,6W 2400lm



9 002759 993375



Ø 240



9 002759 993382



Ø 315



9 002759 997267



Ø 380



99727

LED



99338

LED

### 99727 CRESPILO

surface-mounted light; plastic, white / plastic, white  
Aufbauleuchte; Kunststoff, weiss / Kunststoff, weiss  
luminaire en saillie; plastique, blanc / plastique, blanc

H 65, Ø 500

LED

32,4W

neutral  
WHITE

3600lm



9 002759 997274



Ø 500







94501

LED



94502

LED



94504

LED

### 94501 POLASSO

ceiling light; aluminium, plastic, black, copper  
Deckenleuchte; Alu, Kunststoff, schwarz, kupfer  
plafonnier; aluminium, plastique, noir, cuivre

H 120, Ø 100



1x 3,3W  
1x 340lm



9 002759 945015



### 94504 POLASSO

ceiling light; aluminium, plastic, white, silver  
Deckenleuchte; Alu, Kunststoff, weiss, silber  
plafonnier; aluminium, plastique, blanc, argent

H 120, Ø 100



1x 3,3W  
1x 340lm



9 002759 945046



### 94502 POLASSO

ceiling light; aluminium, plastic, black, gold  
Deckenleuchte; Alu, Kunststoff, schwarz, gold  
plafonnier; aluminium, plastique, noir, or

H 120, Ø 100



1x 3,3W  
1x 340lm



9 002759 945022





94503

LED



94501

LED

### 94503 POLASSO

ceiling light; aluminium, plastic, white, gold  
Deckenleuchte; Alu, Kunststoff, weiss, gold  
plafonnier; aluminium, plastique, blanc, or

H 120, Ø 100

LED

warm  
WHITE



1x 3,3W

1x  
340lm



9 002759 945039



H 120

Ø 100





94496

LED



94499

LED



94497

LED

### 94496 POLASSO

ceiling light; aluminium, plastic, black, copper  
Deckenleuchte; Alu, Kunststoff, schwarz, kupfer  
plafonnier; aluminium, plastique, noir, cuivre

L 100, B 100, H 120



1x 3,3W  
1x 340lm



9 002759 944964

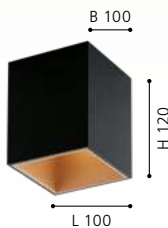

### 94497 POLASSO

ceiling light; aluminium, plastic, black, gold  
Deckenleuchte; Alu, Kunststoff, schwarz, gold  
plafonnier; aluminium, plastique, noir, or

L 100, B 100, H 120



1x 3,3W  
1x 340lm



9 002759 944971

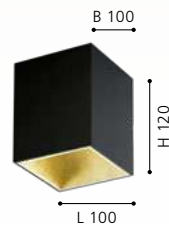

### 94499 POLASSO

ceiling light; aluminium, plastic, white, silver  
Deckenleuchte; Alu, Kunststoff, weiss, silber  
plafonnier; aluminium, plastique, blanc, argent

L 100, B 100, H 120



1x 3,3W  
1x 340lm



9 002759 944995

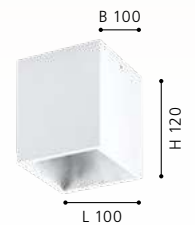



94497

LED





## FERREROS

These luminaires have a special leveling effect.

Diese Leuchten besitzen einen besonderen Stufeneffekt.

Ces luminaires ont un effet escalier spécial.

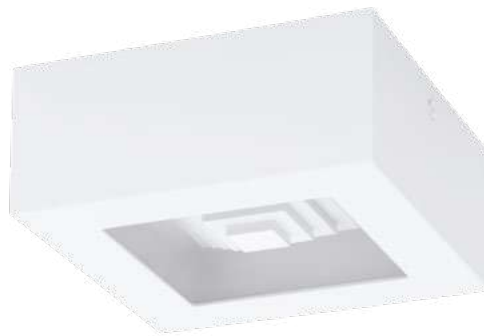

96791

LED

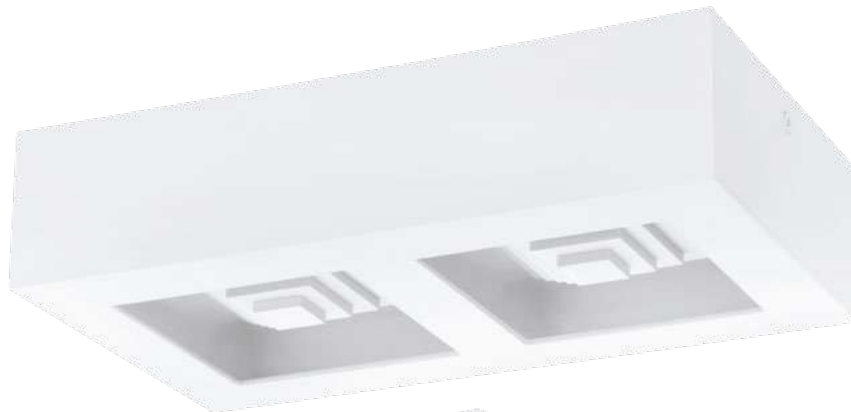

96792

LED

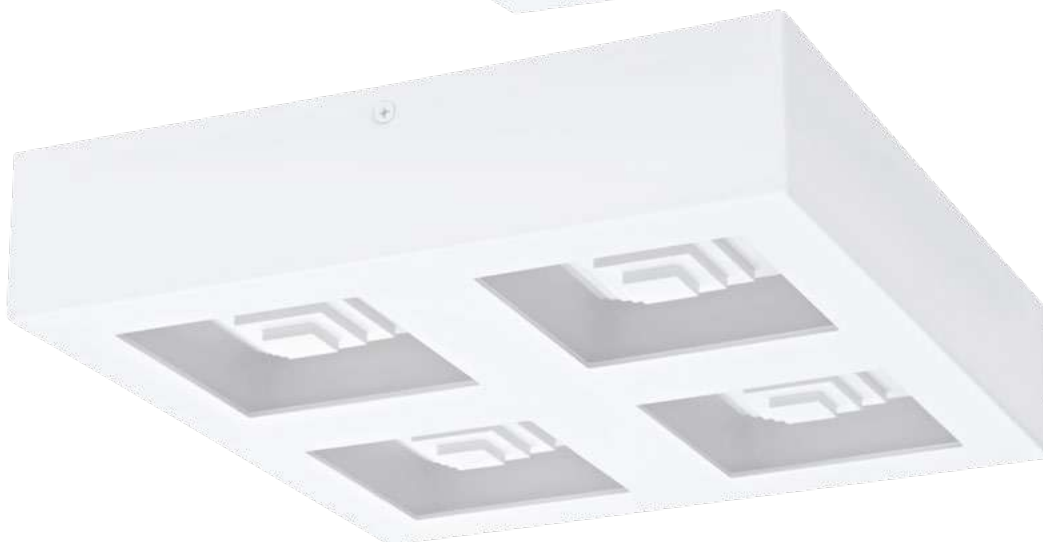

96794

LED

### 96791 FERREROS

wall / ceiling light; steel, white / plastic, white  
Wand- / Deckenleuchte; Stahl, weiss / Kunststoff, weiss  
applique / plafonnier; acier, blanc / plastique, blanc

L 140, B 140, H 60



1x 6,3W  
1x  
840lm



9 002759 967918

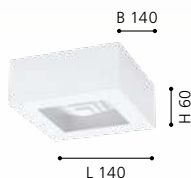

### 96792 FERREROS

wall / ceiling light; steel, white / plastic, white  
Wand- / Deckenleuchte; Stahl, weiss / Kunststoff, weiss  
applique / plafonnier; acier, blanc / plastique, blanc

L 255, B 140, H 60



2x 6,3W  
2x  
840lm



9 002759 967925

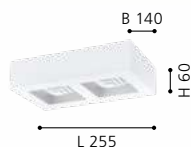

### 96794 FERREROS

wall / ceiling light; steel, white / plastic, white  
Wand- / Deckenleuchte; Stahl, weiss / Kunststoff, weiss  
applique / plafonnier; acier, blanc / plastique, blanc

L 270, B 270, H 60



4x 6,3W  
4x  
840lm



9 002759 967949

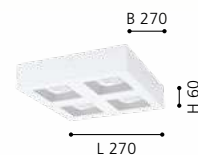





91355

LED



91355

LED

### 91355 LOKE 1

surface-mounted light; aluminium, steel, brushed aluminium, chrome, black

Aufbauleuchte; Alu, Stahl, alu-gebürstet, chrom, schwarz

luminaire en saillie; aluminium, acier, aluminium brossé, chrome, noir

L 250, B 250, A 85



GU10



4x 5W



warm  
WHITE  
4x  
400lm



9 002759 913557







DESIGN  
HIGHLIGHT  
DETAIL



**99066**



**99065**

### 99066 SALUZZO

surface-mounted light; steel, white  
Aufbauleuchte; Stahl, weiss  
luminaire en saillie; acier, blanc

H 110, Ø 65



E27



1x 40W



### 99065 SALUZZO

surface-mounted light; steel, black  
Aufbauleuchte; Stahl, schwarz  
luminaire en saillie; acier, noir

H 110, Ø 65



E27



1x 40W



9 002759 990664



9 002759 990657





99065





**99281**



**99283**

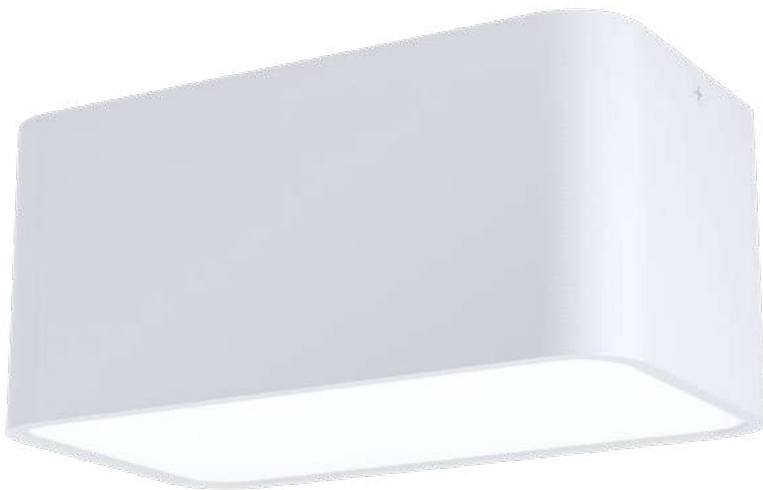

**99282**

### 99281 GRIMASOLA

surface-mounted light; aluminium, steel, white / plastic, white  
Aufbauleuchte; Alu, Stahl, weiss / Kunststoff, weiss  
luminaire en saillie; aluminium, acier, blanc / plastique, blanc

L 140, B 140, H 110



E27



1x 25W

### 99282 GRIMASOLA

surface-mounted light; aluminium, steel, white / plastic, white  
Aufbauleuchte; Alu, Stahl, weiss / Kunststoff, weiss  
luminaire en saillie; aluminium, acier, blanc / plastique, blanc

L 240, B 140, H 110



E27



2x 25W

### 99283 GRIMASOLA

surface-mounted light; aluminium, steel, black / plastic, white  
Aufbauleuchte; Alu, Stahl, schwarz / Kunststoff, weiss  
luminaire en saillie; aluminium, acier, noir / plastique, blanc

L 140, B 140, H 110



E27



1x 25W



9 002759 992811

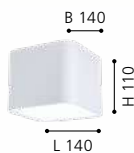

9 002759 992828

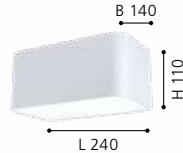

9 002759 992835

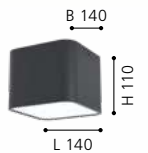



**99284**



**99283**

### 99284 GRIMASOLA

surface-mounted light; aluminium, steel, black / plastic, white  
Aufbauleuchte; Alu, Stahl, schwarz / Kunststoff, weiss  
luminaire en saillie; aluminium, acier, noir / plastique, blanc

L 240, B 140, H 110



E27



2x 25 W

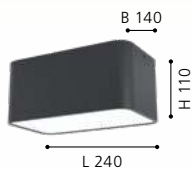



# LED STRIPES

## FLAIR FOR YOUR HOME -

LED STRIPS ARE AVAILABLE IN VARIOUS LENGTHS AND FOR NUMEROUS FIELDS OF APPLICATIONS. CHOOSE YOUR LIGHTING PROGRAMME AND COLOUR IN LINE WITH WHAT SUITS YOUR HOME AND YOUR MOOD. THANKS TO THE ADHESIVE TAPE ON THE BACK OF THE STRIPES, YOU CAN MOUNT THEM ANYWHERE IN NO TIME, USING THEM AS UNDER CABINET LIGHTING IN YOUR KITCHEN OR IN THE LIVING ROOM AREA.

LET YOURSELF BE INSPIRED BY EGLO LED STRIPES!

---

## FLAIR IN IHREM ZUHAUSE -

LED STRIPS IN VERSCHIEDENEN LÄNGEN UND FÜR VIELE EINSATZBEREICHE WERDEN EINFACH MIT EINEM KLEBEBAND BEFESTIGT. JE NACH STIMMUNG KÖNNEN SIE DAS ENTSPRECHENDE LICHTPROGRAMM BZW. DIE GEEIGNETE FARBE AUSWÄHLEN - VON DER INDIRECTEN BELEUCHTUNG IN DER KÜCHENVITRINE BIS HIN ZUM WOHNZIMMER.

LASSEN SIE SICH VON DEN EGLO LED STRIPES INSPIRIEREN!

---

## CRÉER DES AMBIANCES PERSONNALISÉES -

LES LED STRIPS SONT DISPONIBLES EN DIFFÉRENTES TAILLES ET PEUVENT ÊTRE UTILISÉS POUR DE NOMBREUSES APPLICATIONS DIFFÉRENTES. IL EXISTE DES BANDEAUX DE LED ADAPTÉS À CHAQUE PIÈCE. VOUS POURREZ CHOISIR LE PROGRAMME LUMINEUX ET LA COULEUR QUI CORRESPOND LE MIEUX À VOTRE INTÉRIEUR ET VOTRE HUMEUR.

LAISSÉZ-VOUS INSPIRER PAR LES LED STRIPES EGLO !









# FLEXIBLE STRIPES

98571



98572



99716



## ADVANTAGES

- > FREELY FORMABLE
- > SELF-ADHESIVE
- > SEPARABLE EVERY 10 CM
- > OPTIMAL ILLUMINATION EVEN IN CORNERS
- > NO SOLDERING OR INTERMEDIATE PIECE NECESSARY

## VORTEILE

- > FREI FORMBAR
- > SELBSTKLEBEND
- > ALLE 10 CM KÜRZBAR
- > OPTIMALE AUSLEUCHTUNG AUCH IN ECKEN
- > KEIN LÖTEN ODER ZWISCHENSTÜCK NOTWENDIG

## ADVANTAGES

- > SE DÉFORME AISÉMENT
- > AUTO-ADHÉSIF
- > PEUT ÊTRE SECTIONNÉ TOUS LES 10 CM
- > UN ÉCLAIRAGE OPTIMAL, MÊME DANS LES COINS
- > PAS DE SOUDURE OU DE PIÈCE INTERMÉDIAIRE NÉCESSAIRE

### 98571 FLEXIBLE STRIPE

bar / strip light; plastic, white  
Leuchtband/-stab; Kunststoff, weiss  
bande lumineuse / bâton l; plastique, blanc

L 2000, B 6



9,6W 1050lm



9 002759 985714

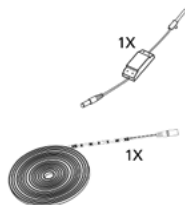

L 2000

### 98572 FLEXIBLE STRIPE

bar / strip light; plastic, white  
Leuchtband/-stab; Kunststoff, weiss  
bande lumineuse / bâton l; plastique, blanc

L 5000, B 6



18,5W 2100lm



9 002759 985721

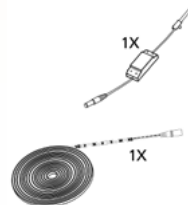

L 5000

### 99716 FLEXIBLE STRIPE

bar / strip light; white  
Leuchtband/-stab; weiss  
bande lumineuse / bâton l; blanc

L 8000, B 6



43,2W 4800lm



9 002759 997168

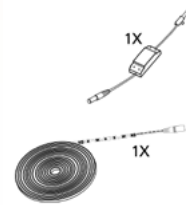

L 8000



99717



99718



99719



### 99717 FLEXIBLE STRIPE

bar / strip light; white  
Leuchtband/-stab; weiss  
bande lumineuse / bâton l; blanc

L 2000, B 6



10,8W 1200lm



9 002759 997175

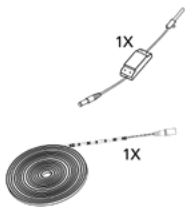

L 2000

### 99718 FLEXIBLE STRIPE

bar / strip light; white  
Leuchtband/-stab; weiss  
bande lumineuse / bâton l; blanc

L 5000, B 6



27W 3000lm



9 002759 997182

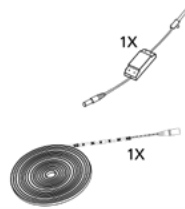

L 5000

### 99719 FLEXIBLE STRIPE

bar / strip light; white  
Leuchtband/-stab; weiss  
bande lumineuse / bâton l; blanc

L 8000, B 8



43,2W 4800lm



9 002759 997199

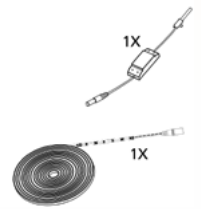

L 8000



**99721**



**99722**



**99723**



**99721, 99722, 99723**

These articles include a remote control.

Bei diesen Artikeln ist eine Fernbedienung inkludiert.

Ces articles comprennent une télécommande.

**99721 FLEXIBLE STRIPE**

bar / strip light; white  
Leuchtband/-stab; weiss  
bande lumineuse / bâton l; blanc

**99722 FLEXIBLE STRIPE**

bar / strip light; white  
Leuchtband/-stab; weiss  
bande lumineuse / bâton l; blanc

**99723 FLEXIBLE STRIPE**

bar / strip light; white  
Leuchtband/-stab; weiss  
bande lumineuse / bâton l; blanc

L 2000, B 8



9,2W 920lm



9 002759 997212

L 2000

L 5000, B 8



23W 2300lm

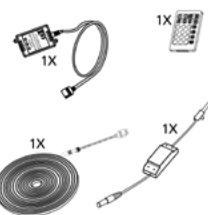

9 002759 997229

L 5000

L 8000, B 8



36,8W 3680lm



9 002759 997236

L 8000

98573



98574

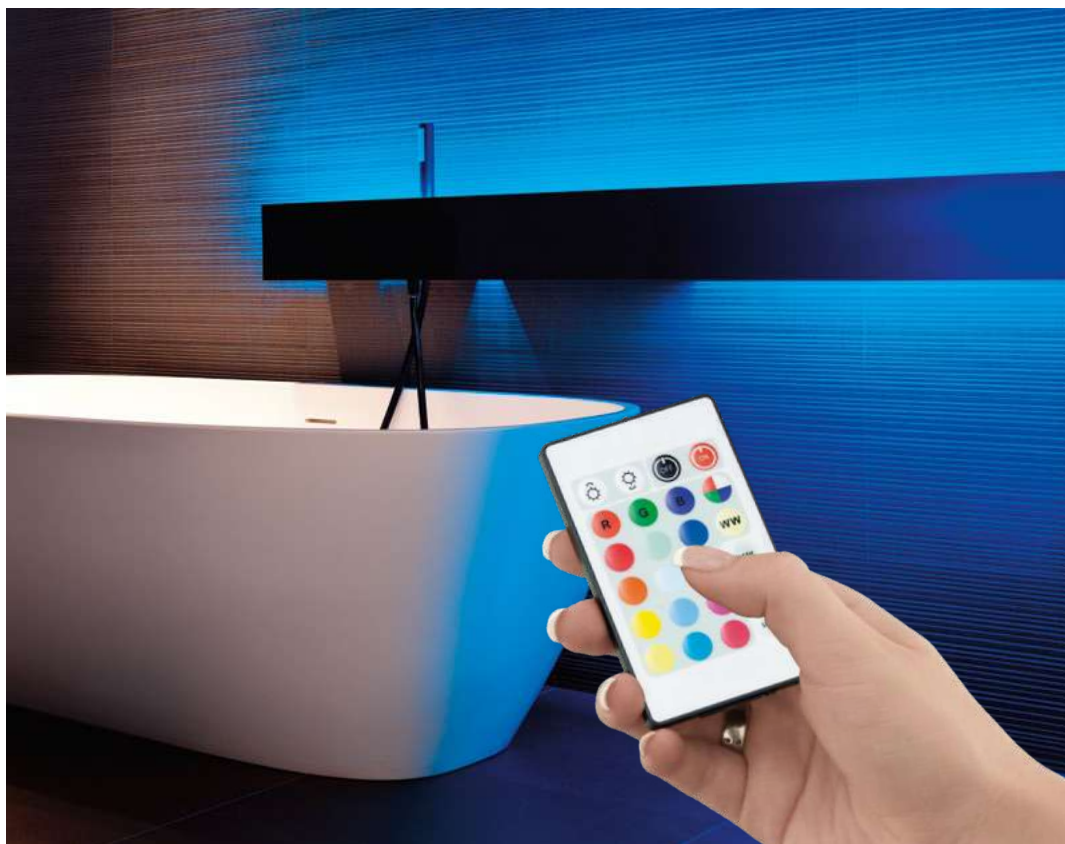

**98573 FLEXIBLE STRIPE**

bar / strip light; plastic, white  
Leuchtband/-stab; Kunststoff, weiss  
bande lumineuse / bâton l; plastique, blanc

L 2000, B 8



9,7W



L 2000



9 002759 985738

**98574 FLEXIBLE STRIPE**

bar / strip light; plastic, white  
Leuchtband/-stab; Kunststoff, weiss  
bande lumineuse / bâton l; plastique, blanc

L 5000, B 8



19,5W



L 5000



9 002759 985745

**98573, 98574**

These articles include a remote control.

Bei diesen Artikeln ist eine Fernbedienung inkludiert.

Ces articles comprennent une télécommande.



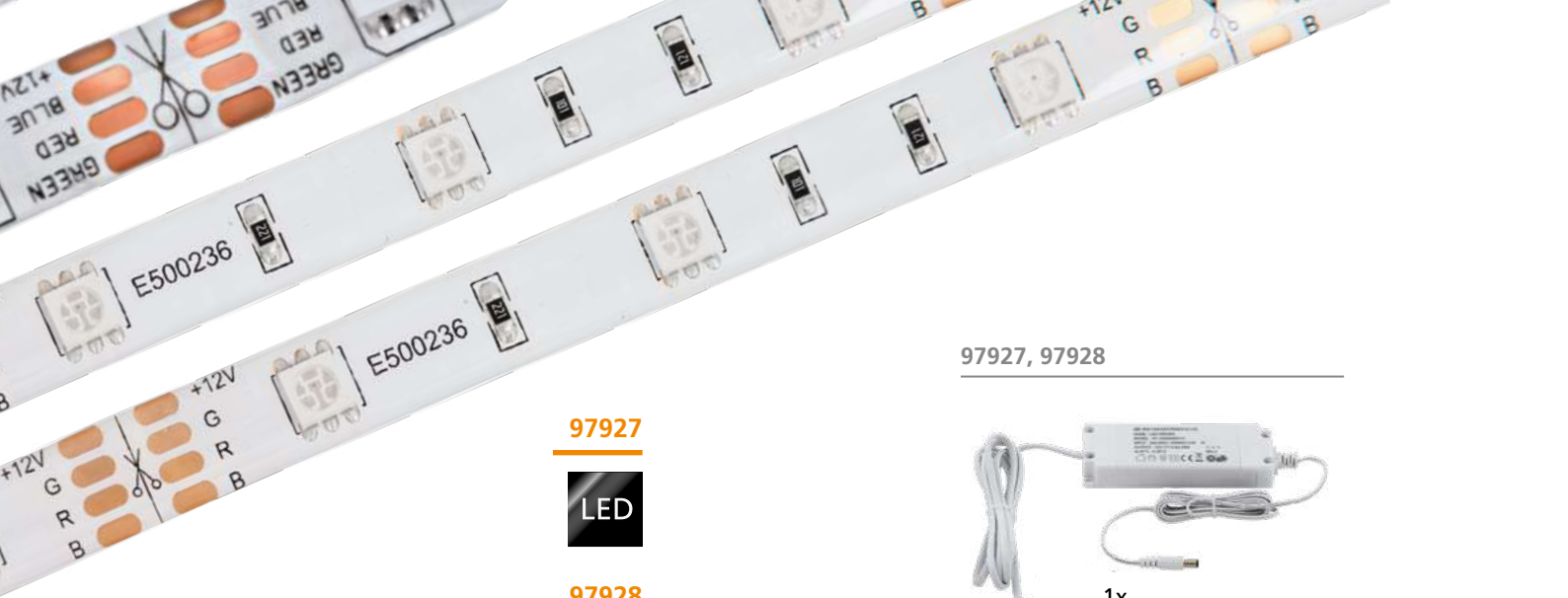

97927, 97928

97927



97928



97924



REMOTE CONTROL

With the aid of the remote control, all LED STRIPES can be dimmed. The "not dimmable" sign shown in the technical info is only valid for utilisation without the remote control.

Mit Hilfe der Fernbedienung können sämtliche LED-STRIPES gedimmt werden. Das „nicht dimmbar“ Zeichen in der technischen Information trifft nur für die Benutzung ohne Fernbedienung zu.

Au moyen de la télécommande, tous les LED STRIPES peuvent être gradués. Le signe « non graduable » dans l'information technique n'est valable que dans le cas d'utilisation sans télécommande.

\*This note indicates that the remote control is included with the delivery.

\*Bei diesem Hinweis ist die Fernbedienung im Lieferumfang enthalten!

\*Avec cette remarque, la télécommande est comprise dans l'étendue de la livraison !

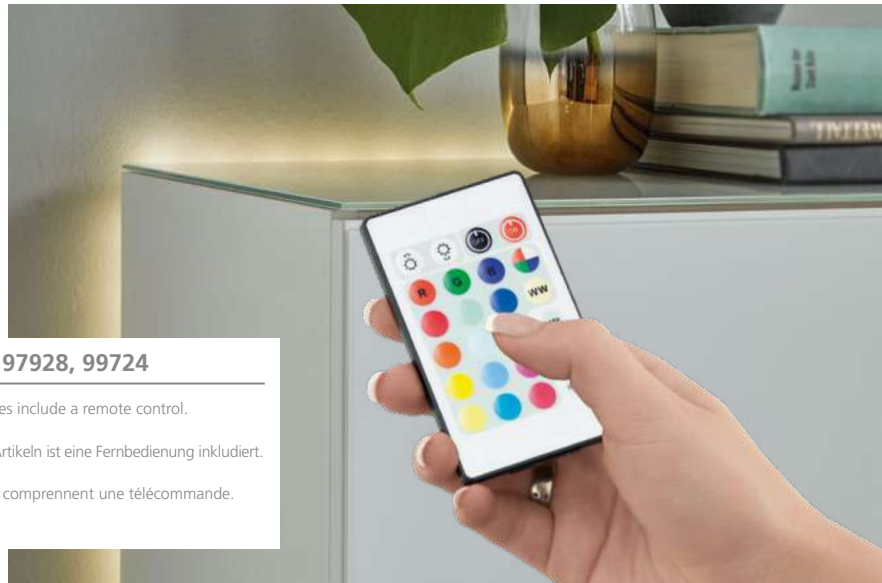

97927, 97928, 97924

These articles include a remote control.

Bei diesen Artikeln ist eine Fernbedienung inkludiert.

Ces articles comprennent une télécommande.

97924 FLEXIBLE STRIPE

bar / strip light; white  
Leuchtband/-stab; weiss  
bande lumineuse / bâton l; blanc

L 8000, B 8



38,4W

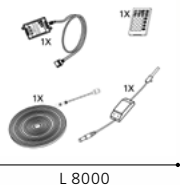

L 8000



9 002759 997243

97928 LED STRIPES-FLEX

bar / strip light; plastic, transparent  
Leuchtband/-stab; Kunststoff, transparent  
bande lumineuse / bâton l; plastique, transparent

L 5000, B 10, H 3



20W

1000lm

remote



10

L 5000



9 002759 979287



97927 LED STRIPES-FLEX

bar / strip light; plastic, transparent  
Leuchtband/-stab; Kunststoff, transparent  
bande lumineuse / bâton l; plastique, transparent

L 2000, B 10, H 3



10W

600lm

remote



10

L 2000



9 002759 979270





97029



97029

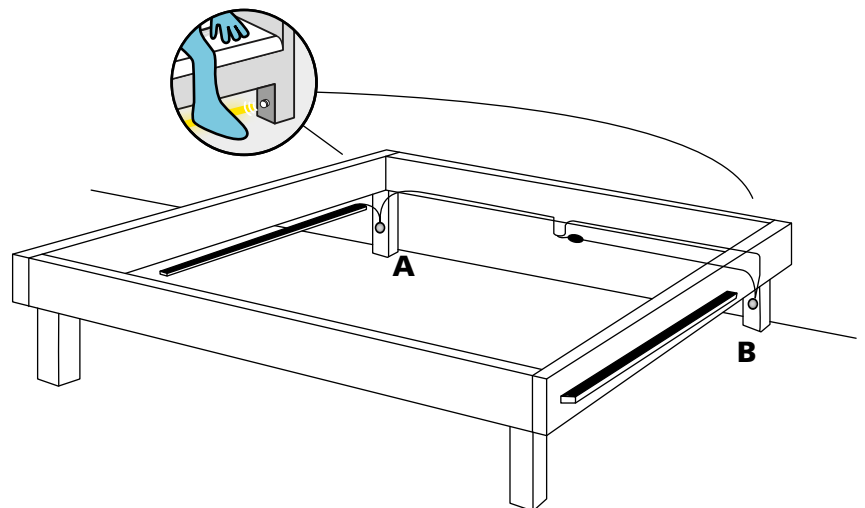

### 97029 PIDIO

bar / strip light; plastic, white  
 Leuchtband/-stab; Kunststoff, weiss  
 bande lumineuse / bâton l; plastique, blanc

L 2400, B 8, H 2



36x 0,1W 225lm 36x 0,1W



10



L 2400

### 97029 PIDIO

This sensor strip is designed to be attached to the side of the bed. Properly placed and connected to the supplied LED lights, it will illuminate the base of your bed. The sensor has a 100 degree detection angle and a 3.5m range. It can be set to automatically activate the light between 30 seconds and 10 minutes.

Diese Sensorleiste ist so konzipiert, dass sie an der Seite des Bettes befestigt werden kann. Richtig platziert und mit den mitgelieferten LED-Streifenleuchten verbunden, kann damit ihr Bett unterleuchtet werden. Der Sensor hat einen 100 Grad Erfassungsbereich mit einer Reichweite von 3,5 m Reichweite. Er kann so eingestellt werden, dass das Licht zwischen 30 Sekunden und 10 Minuten automatisch aktiviert wird.

Cette barre de capteur est conçu de telle sorte qu'il peut être fixé sur le côté du lit. Correctement placé et connecté à la bande LED fournis, il allume la base du lit. Le capteur a un arc de 100 degrés et une portée de 3,5 m. Il peut être réglé de telle sorte que la lumière est activé entre 30 secondes et 10 minutes automatiquement.





# LED PROFILES

## ADVANTAGES

- > SIMPLE AND FAST INSTALLATION
  - > DIFFERENT SHAPES AND SIZES
  - > VARIETY OF COLOURS
  - > PROFILES GIVE LED STRIPES A MORE ELEGANT DESIGN
  - > PROTECTION AGAINST MECHANICAL STRESS OF THE LED STRIPES
- 





























## VORTEILE

- > EINFACHE UND SCHNELLE MONTAGE
  - > UNTERSCHIEDLICHE FORMEN UND GRÖSSEN
  - > FARBENVIELFALT
  - > PROFILE VERLEIHEN LED-STRIPES EIN EDLERES DESIGN
  - > SCHUTZ VOR MECHANISCHER BEANSPRUCHUNG DER LED STRIPES
- 

## ADVANTAGES

- > INSTALLATION SIMPLE ET RAPIDE
- > DIFFÉRENTES FORMES ET TAILLES
- > VARIÉTÉ DE COULEURS
- > LES PROFILS DONNENT AUX BANDES LED UN DESIGN PLUS ÉLÉGANT
- > PROTECTION CONTRE LES CONTRAINTES MÉCANIQUES DES BANDES LED

# OVERVIEW

 SURFACE PROFILE 1 p. 270-272	 SURFACE PROFILE 1 p. 270-272	 SURFACE PROFILE 1 p. 270-272	 SURFACE PROFILE 2 p. 273-275	 SURFACE PROFILE 2 p. 273-275	 SURFACE PROFILE 2 p. 273-275	 SURFACE PROFILE 3 p. 276-278	 SURFACE PROFILE 3 p. 276-278
 SURFACE PROFILE 3 p. 276-278	 CORNER PROFILE 1 p. 280-285	 CORNER PROFILE 1 p. 280-285	 CORNER PROFILE 1 p. 280-285	 CORNER PROFILE 2 p. 286-291	 CORNER PROFILE 2 p. 286-291	 CORNER PROFILE 2 p. 286-291	 SURFACE PROFILE 4 p. 292-293
 SURFACE PROFILE 4 p. 292-293	 SURFACE PROFILE 4 p. 292-293	 RECESSED PROFILE 1 p. 294-296	 RECESSED PROFILE 1 p. 294-296	 RECESSED PROFILE 1 p. 294-296	 RECESSED PROFILE 2 p. 297-299	 RECESSED PROFILE 2 p. 297-299	 RECESSED PROFILE 2 p. 297-299
 SURFACE PROFILE 5 p. 300	 RECESSED PROFILE 3 p. 302-303	 RECESSED PROFILE 3 p. 302-303	 RECESSED PROFILE 3 p. 302-303	 SURFACE PROFILE 6 p. 304-305	 SURFACE PROFILE 6 p. 304-305	 SURFACE PROFILE 6 p. 304-305	 RECESSED PROFILE 4 p. 306-309
 RECESSED PROFILE 4 p. 306-309							

 This product is available in different colors and shapes./ Dieser Artikel ist in unterschiedlichen Farben und Formen verfügbar.  
Cet article est disponible en différentes couleurs et formes.



# LED CORNER CONNECTORS

## ADVANTAGES

- > PREFABRICATED 90° CORNER CONNECTORS
  - > NO MITRE SAWING NECESSARY
  - > EASY MOUNTING
  - > SUITABLE FOR INSIDE AND OUTSIDE CORNERS
  - > BRACKETS INCLUDED
- 

## VORTEILE

- > VORGEFERTIGTE 90° ECKVERBINDER
  - > KEIN GEHRUNGSSÄGEN NOTWENDIG
  - > EINFACHE MONTAGE
  - > FÜR INNEN- UND AUSSENECKEN EINSETZBAR
  - > HALTERUNGEN INKLUSIVE
- 

## ADVANTAGES

- > CONNECTEURS D'ANGLE À 90° PRÉFABRIQUÉS
- > PAS DE SCIAGE EN ONGLET NÉCESSAIRE
- > MONTAGE FACILE
- > CONVIENT AUX ANGLES INTÉRIEURS ET EXTÉRIEURS
- > ENTRE PARENTHÈSES

**1**

x2

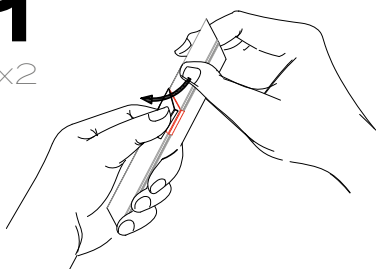

**2**

x2

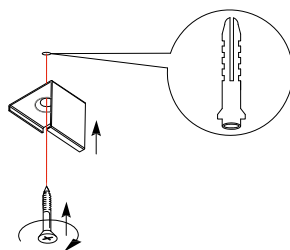

**3**

x2

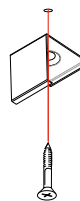

**4**

x2

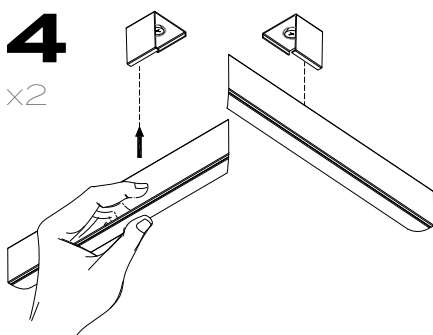

**5**

x2

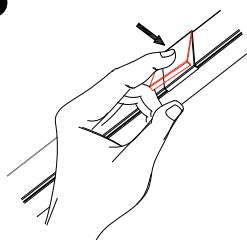

**6**

x2

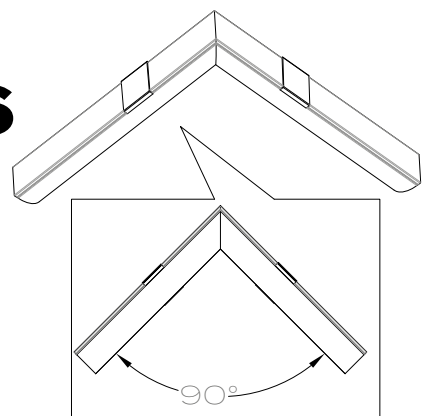

# OVERVIEW



SURFACE  
PROFILE 1  
p. 270



SURFACE  
PROFILE 1  
p. 271



SURFACE  
PROFILE 1  
p. 272



SURFACE  
PROFILE 2  
p. 273



SURFACE  
PROFILE 2  
p. 274



SURFACE  
PROFILE 2  
p. 275



SURFACE  
PROFILE 3  
p. 276



SURFACE  
PROFILE 3  
p. 277



SURFACE  
PROFILE 3  
p. 278



CORNER  
PROFILE 1  
p. 280



CORNER  
PROFILE 1  
p. 281



CORNER  
PROFILE 1  
p. 282



CORNER  
PROFILE 1  
p. 283



CORNER  
PROFILE 1  
p. 284



CORNER  
PROFILE 1  
p. 285



CORNER  
PROFILE 2  
p. 286



CORNER  
PROFILE 2  
p. 287



CORNER  
PROFILE 2  
p. 288



CORNER  
PROFILE 2  
p. 289



CORNER  
PROFILE 2  
p. 290



CORNER  
PROFILE 2  
p. 291



RECESSED  
PROFILE 1  
p. 294



RECESSED  
PROFILE 1  
p. 295



RECESSED  
PROFILE 1  
p. 296



RECESSED  
PROFILE 2  
p. 297



RECESSED  
PROFILE 2  
p. 298



RECESSED  
PROFILE 2  
p. 299

INCLUDED IN DELIVERY /  
im Lieferumfang enthalten /  
inclus dans la livraison



98911  
98912



98914  
98915

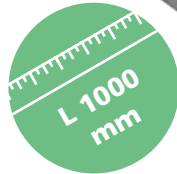

**98911**

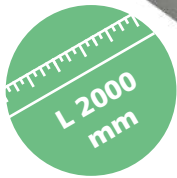

**98912**



**98913**

### 98911 SURFACE PROFILE 1

accessory; aluminium, aluminium / plastic, white  
Zubehör; Alu, alu / Kunststoff, weiss  
accessoire; aluminium, aluminium / plastique, blanc

L 1000, B 17, H 9



9 002759 989118

### 98912 SURFACE PROFILE 1

accessory; aluminium, aluminium / plastic, white  
Zubehör; Alu, alu / Kunststoff, weiss  
accessoire; aluminium, aluminium / plastique, blanc

L 2000, B 17, H 9



9 002759 989125

### 98913 SURFACE PROFILE 1

accessory; aluminium, aluminium  
Zubehör; Alu, alu  
accessoire; aluminium, aluminium

L 110



9 002759 989132

## SURFACE PROFILES

incl. end caps & mounting clips



**98914**

L 1000  
mm



**98915**

L 2000  
mm



**98916**

### 98914 SURFACE PROFILE 1

accessory; aluminium, white / plastic, white  
Zubehör; Alu, weiss / Kunststoff, weiss  
accessoire; aluminium, blanc / plastique, blanc

L 1000, B 17, H 9



9 002759 989149

### 98915 SURFACE PROFILE 1

accessory; aluminium, white / plastic, white  
Zubehör; Alu, weiss / Kunststoff, weiss  
accessoire; aluminium, blanc / plastique, blanc

L 2000, B 17, H 9



9 002759 989156

### 98916 SURFACE PROFILE 1

accessory; aluminium, white  
Zubehör; Alu, weiss  
accessoire; aluminium, blanc

L 110



9 002759 989163

### PROFILE CROSS-SECTION / Profilquerschnitt / section de profil

98911 98913 98915  
98912 98914 98916

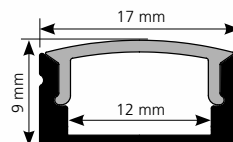



**INCLUDED IN DELIVERY /**  
im Lieferumfang enthalten /  
inclus dans la livraison



98917  
98918



98921  
98922



L 1000  
mm

**98917**



L 2000  
mm

**98918**



**98919**

### 98917 SURFACE PROFILE 1

accessory; aluminium, black / plastic, white  
Zubehör; Alu, schwarz / Kunststoff, weiss  
accessoire; aluminium, noir / plastique, blanc

L 1000, B 17, H 9



9 002759 989170

### 98918 SURFACE PROFILE 1

accessory; aluminium, black / plastic, white  
Zubehör; Alu, schwarz / Kunststoff, weiss  
accessoire; aluminium, noir / plastique, blanc

L 2000, B 17, H 9



9 002759 989187

### 98919 SURFACE PROFILE 1

accessory; aluminium, anodised black  
Zubehör; Alu, schwarz eloxiert  
accessoire; aluminium, noir anodisé

L 110



9 002759 989194

## SURFACE PROFILES

incl. end caps & mounting clips

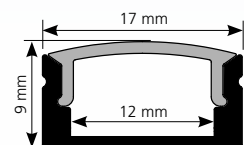

98917 98919  
98918





L 1000  
mm

**98924**



L 2000  
mm

**98925**

**INCLUDED IN DELIVERY /**  
im Lieferumfang enthalten /  
inclus dans la livraison



98924  
98925



98927  
98928



**98926**

### 98924 SURFACE PROFILE 2

accessory; aluminium, white / plastic, white  
Zubehör; Alu, weiss / Kunststoff, weiss  
accessoire; aluminium, blanc / plastique, blanc

L 1000, B 17, H 16



9 002759 989248

### 98925 SURFACE PROFILE 2

accessory; aluminium, white / plastic, white  
Zubehör; Alu, weiss / Kunststoff, weiss  
accessoire; aluminium, blanc / plastique, blanc

L 2000, B 17, H 16



9 002759 989255

### 98926 SURFACE PROFILE 2

accessory; aluminium, white  
Zubehör; Alu, weiss  
accessoire; aluminium, blanc

L 110



9 002759 989262

# SURFACE PROFILES

incl. end caps & mounting clips



**98927 SURFACE PROFILE 2**

accessory; aluminium, black / plastic, white  
 Zubehör; Alu, schwarz / Kunststoff, weiss  
 accessoire; aluminium, noir / plastique, blanc

L 1000, B 17, H 16



**98928 SURFACE PROFILE 2**

accessory; aluminium, black / plastic, white  
 Zubehör; Alu, schwarz / Kunststoff, weiss  
 accessoire; aluminium, noir / plastique, blanc

L 2000, B 17, H 16



**98929 SURFACE PROFILE 2**

accessory; aluminium, anodised black  
 Zubehör; Alu, schwarz eloxiert  
 accessoire; aluminium, noir anodisé

L 110



**PROFILE CROSS-SECTION /**  
 Profilquerschnitt / section de profil

98924 98926 98928  
 98925 98927 98929

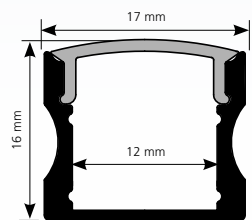

**INCLUDED IN DELIVERY /**  
im Lieferumfang enthalten /  
inclus dans la livraison



98931  
98932



98937  
98938



**98931**

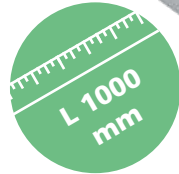

**98932**

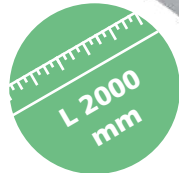

**98933**

**98931 SURFACE PROFILE 3**

accessory; aluminium, aluminium / plastic, transparent  
Zubehör; Alu, alu / Kunststoff, transparent  
accessoire; aluminium, aluminium / plastique, transparent

L 1000, B 17, H 20



9 002759 989316

**98932 SURFACE PROFILE 3**

accessory; aluminium, aluminium / plastic, transparent  
Zubehör; Alu, alu / Kunststoff, transparent  
accessoire; aluminium, aluminium / plastique, transparent

L 2000, B 17, H 20



9 002759 989323

**98933 SURFACE PROFILE 3**

accessory; aluminium, aluminium  
Zubehör; Alu, alu  
accessoire; aluminium, aluminium

L 110



9 002759 989330

**SURFACE PROFILES WITH 30° LINEAR LENS**

incl. end caps & mounting clips



**98937**

L 1000  
mm



**98938**

L 2000  
mm



**98939**

**98937 SURFACE PROFILE 3**

accessory; aluminium, black / plastic, transparent  
Zubehör; Alu, schwarz / Kunststoff, transparent  
accessoire; aluminium, noir / plastique, transparent

L 1000, B 17, H 20



**98938 SURFACE PROFILE 3**

accessory; aluminium, black / plastic, transparent  
Zubehör; Alu, schwarz / Kunststoff, transparent  
accessoire; aluminium, noir / plastique, transparent

L 2000, B 17, H 20



**98939 SURFACE PROFILE 3**

accessory; aluminium, anodised black  
Zubehör; Alu, schwarz eloxiert  
accessoire; aluminium, noir anodisé

L 110



**PROFILE CROSS-SECTION /**  
Profilquerschnitt / section de profil

98931 98933 98938  
98932 98937 98939

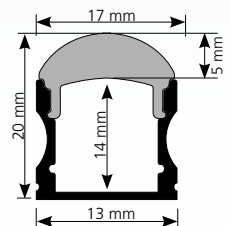



INCLUDED IN DELIVERY /  
im Lieferumfang enthalten /  
inclus dans la livraison



98934  
98935



98934



98935



98936

### 98934 SURFACE PROFILE 3

accessory; aluminium, white / plastic, transparent  
Zubehör; Alu, weiss / Kunststoff, transparent  
accessoire; aluminium, blanc / plastique, transparent

L 1000, B 17, H 20



### 98935 SURFACE PROFILE 3

accessory; aluminium, white / plastic, transparent  
Zubehör; Alu, weiss / Kunststoff, transparent  
accessoire; aluminium, blanc / plastique, transparent

L 2000, B 17, H 20



### 98936 SURFACE PROFILE 3

accessory; aluminium, white  
Zubehör; Alu, weiss  
accessoire; aluminium, blanc

L 110



## SURFACE PROFILES WITH 30° LINEAR LENS

incl. end caps & mounting clips



**PROFILE CROSS-SECTION /**  
Profilquerschnitt / section de profil

98934 98936  
98935

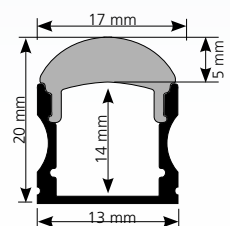

INCLUDED IN DELIVERY /  
im Lieferumfang enthalten /  
inclus dans la livraison



98941  
98942

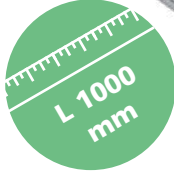

**98941**

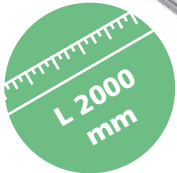

**98942**



**98943**

### 98941 CORNER PROFILE 1

accessory; aluminium, aluminium / plastic, white  
Zubehör; Alu, alu / Kunststoff, weiss  
accessoire; aluminium, aluminium / plastique, blanc

L 1000, H 16



9 002759 989415

### 98942 CORNER PROFILE 1

accessory; aluminium, aluminium / plastic, white  
Zubehör; Alu, alu / Kunststoff, weiss  
accessoire; aluminium, aluminium / plastique, blanc

L 2000, H 16



9 002759 989422

### 98943 CORNER PROFILE 1

accessory; aluminium, aluminium  
Zubehör; Alu, alu  
accessoire; aluminium, aluminium

L 110



9 002759 989439

# CORNER PROFILES

incl. end caps & mounting clips

98944

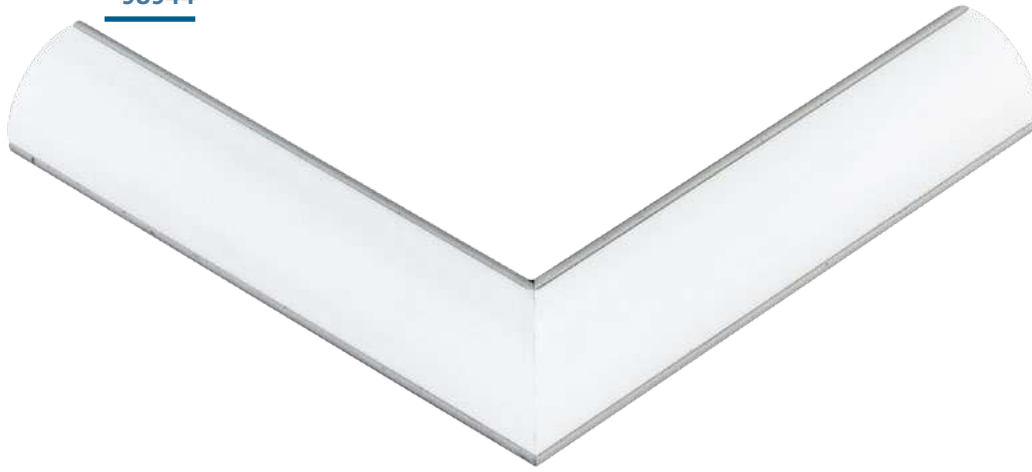

**98944 CORNER PROFILE 1**

accessory; aluminium, aluminium  
Zubehör; Alu, alu  
accessoire; aluminium, aluminium

L 110



**PROFILE CROSS-SECTION /**  
Profilquerschnitt / section de profil

98941 98943  
98942 98944

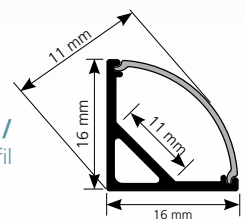

**INCLUDED IN DELIVERY /**  
im Lieferumfang enthalten /  
inclus dans la livraison



98945  
98946



L 1000  
mm

**98945**



L 2000  
mm

**98946**



**98947**

**98945 CORNER PROFILE 1**

accessory; aluminium, white / plastic, white  
Zubehör; Alu, weiss / Kunststoff, weiss  
accessoire; aluminium, blanc / plastique, blanc

L 1000, H 16



9 002759 989453

**98946 CORNER PROFILE 1**

accessory; aluminium, white / plastic, white  
Zubehör; Alu, weiss / Kunststoff, weiss  
accessoire; aluminium, blanc / plastique, blanc

L 2000, H 16



9 002759 989460

**98947 CORNER PROFILE 1**

accessory; aluminium, white  
Zubehör; Alu, weiss  
accessoire; aluminium, blanc

L 110



9 002759 989477

**PROFILE CROSS-SECTION /**  
Profilquerschnitt / section de profil

98945 98947  
98946 98948

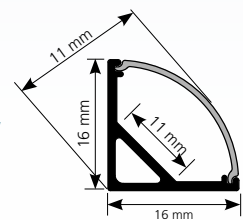

**CORNER PROFILES**

incl. end caps & mounting clips

**98948**

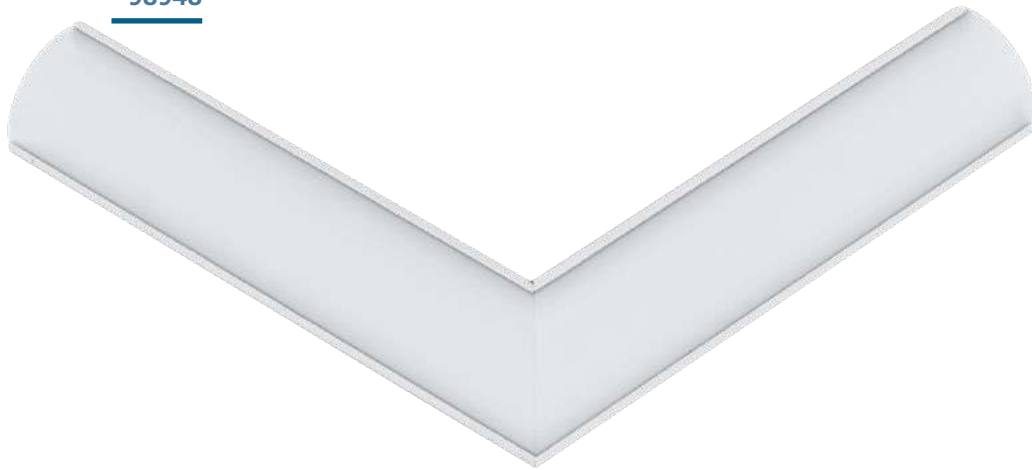

**98948 CORNER PROFILE 1**

accessory; aluminium, white  
Zubehör; Alu, weiss  
accessoire; aluminium, blanc

L 110

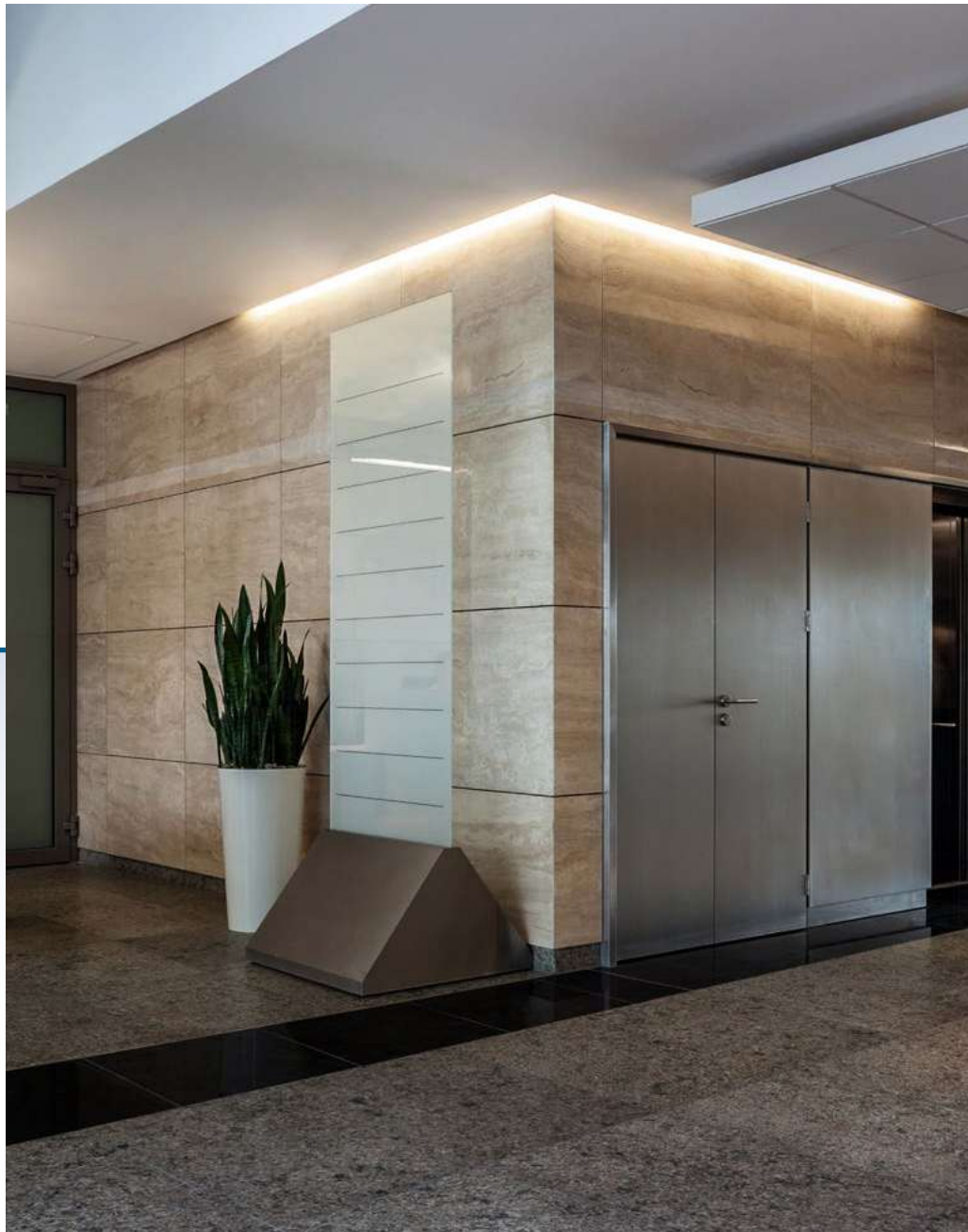



INCLUDED IN DELIVERY /

im Lieferumfang enthalten /  
inclus dans la livraison



98949  
98951

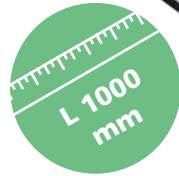

98949

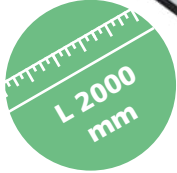

98951



98952

### 98949 CORNER PROFILE 1

accessory; aluminium, black / plastic, white  
Zubehör; Alu, schwarz / Kunststoff, weiss  
accessoire; aluminium, noir / plastique, blanc

L 1000, H 16



9 002759 989491

### 98951 CORNER PROFILE 1

accessory; aluminium, black / plastic, white  
Zubehör; Alu, schwarz / Kunststoff, weiss  
accessoire; aluminium, noir / plastique, blanc

L 2000, H 16



9 002759 989514

### 98952 CORNER PROFILE 1

accessory; aluminium, anodised black  
Zubehör; Alu, schwarz eloxiert  
accessoire; aluminium, noir anodisé

L 110



9 002759 989521

# CORNER PROFILES

incl. end caps & mounting clips

98953

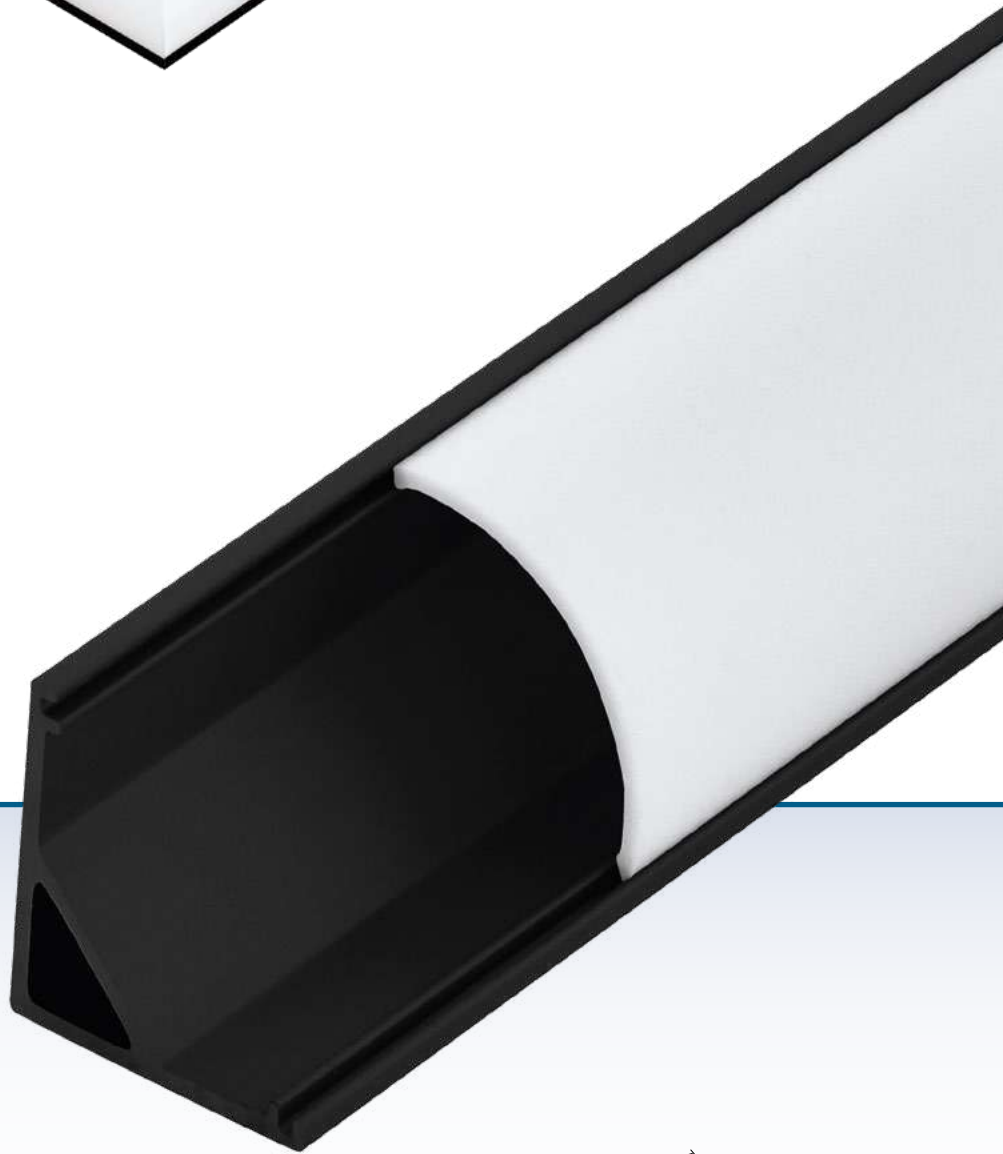
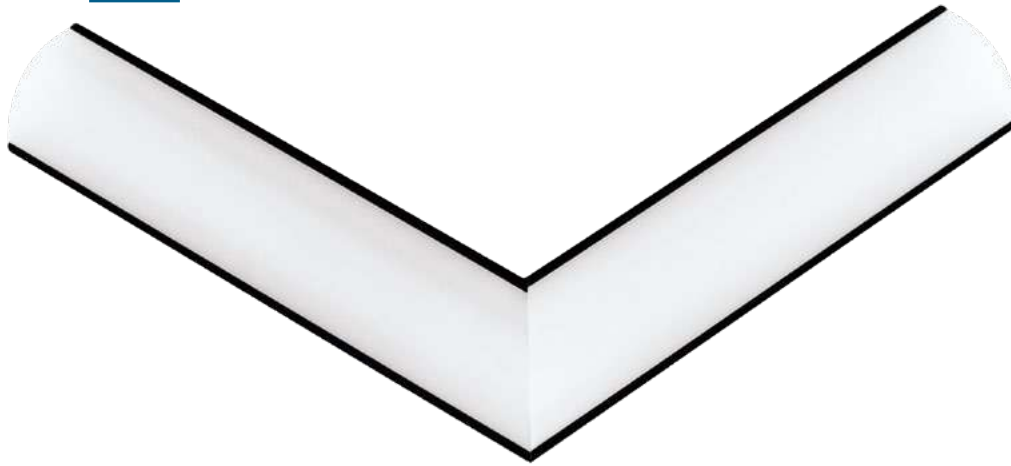

**98953 CORNER PROFILE 1**

accessory; aluminium, anodised black  
Zubehör; Alu, schwarz eloxiert  
accessoire; aluminium, noir anodisé

L 110



9 002759 989538

**PROFILE CROSS-SECTION /**  
Profilquerschnitt / section de profil

98949 98952  
98951 98953

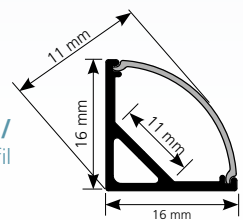

**INCLUDED IN DELIVERY /**  
im Lieferumfang enthalten /  
inclus dans la livraison



98954  
98955

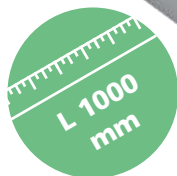

**98954**

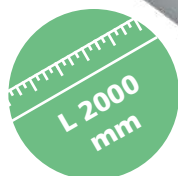

**98955**



**98956**

### 98954 CORNER PROFILE 2

accessory; aluminium, aluminium / plastic, white  
Zubehör; Alu, alu / Kunststoff, weiss  
accessoire; aluminium, aluminium / plastique, blanc

L 1000, B 18, H 18



9 002759 989545

### 98955 CORNER PROFILE 2

accessory; aluminium, aluminium / plastic, white  
Zubehör; Alu, alu / Kunststoff, weiss  
accessoire; aluminium, aluminium / plastique, blanc

L 2000, B 18, H 18



9 002759 989552

### 98956 CORNER PROFILE 2

accessory; aluminium, aluminium  
Zubehör; Alu, alu  
accessoire; aluminium, aluminium

L 110



9 002759 989569

# CORNER PROFILES

incl. end caps & mounting clips

**PROFILE CROSS-SECTION /**  
Profilquerschnitt / section de profil

98954 98956  
98955 98957

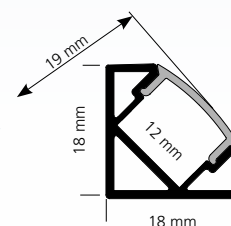

**98957**



**98957 CORNER PROFILE 2**

accessory; aluminium, aluminium  
Zubehör; Alu, alu  
accessoire; aluminium, aluminium

L 110



INCLUDED IN DELIVERY /  
im Lieferumfang enthalten /  
inclus dans la livraison



98958  
98959

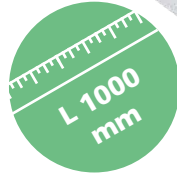

**98958**



**98959**



**98961**

### 98958 CORNER PROFILE 2

accessory; aluminium, white / plastic, white  
Zubehör; Alu, weiss / Kunststoff, weiss  
accessoire; aluminium, blanc / plastique, blanc

### 98959 CORNER PROFILE 2

accessory; aluminium, white / plastic, white  
Zubehör; Alu, weiss / Kunststoff, weiss  
accessoire; aluminium, blanc / plastique, blanc

### 98961 CORNER PROFILE 2

accessory; aluminium, white  
Zubehör; Alu, weiss  
accessoire; aluminium, blanc

L 1000, B 18, H 18



9 002759 989583

L 2000, B 18, H 18



9 002759 989590

L 110



9 002759 989613

## CORNER PROFILES

incl. end caps & mounting clips

**98962**



**98962 CORNER PROFILE 2**

accessory; aluminium, white  
Zubehör; Alu, weiss  
accessoire; aluminium, blanc

L 110



**PROFILE CROSS-SECTION /**  
Profilquerschnitt / section de profil

98958 98961  
98959 98962

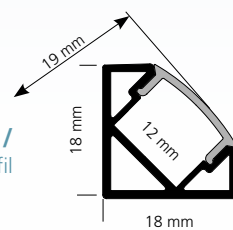



INCLUDED IN DELIVERY /  
im Lieferumfang enthalten /  
inclus dans la livraison



98963  
98964

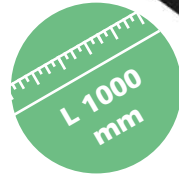

**98963**



**98964**



**98965**

### 98963 CORNER PROFILE 2

accessory; aluminium, black / plastic, white  
Zubehör; Alu, schwarz / Kunststoff, weiss  
accessoire; aluminium, noir / plastique, blanc

### 98964 CORNER PROFILE 2

accessory; aluminium, black / plastic, white  
Zubehör; Alu, schwarz / Kunststoff, weiss  
accessoire; aluminium, noir / plastique, blanc

### 98965 CORNER PROFILE 2

accessory; aluminium, anodised black  
Zubehör; Alu, schwarz eloxiert  
accessoire; aluminium, noir anodisé

L 1000, B 18, H 18



9 002759 989637

L 2000, B 18, H 18



9 002759 989644

L 110



9 002759 989651

## CORNER PROFILES

incl. end caps & mounting clips

98966

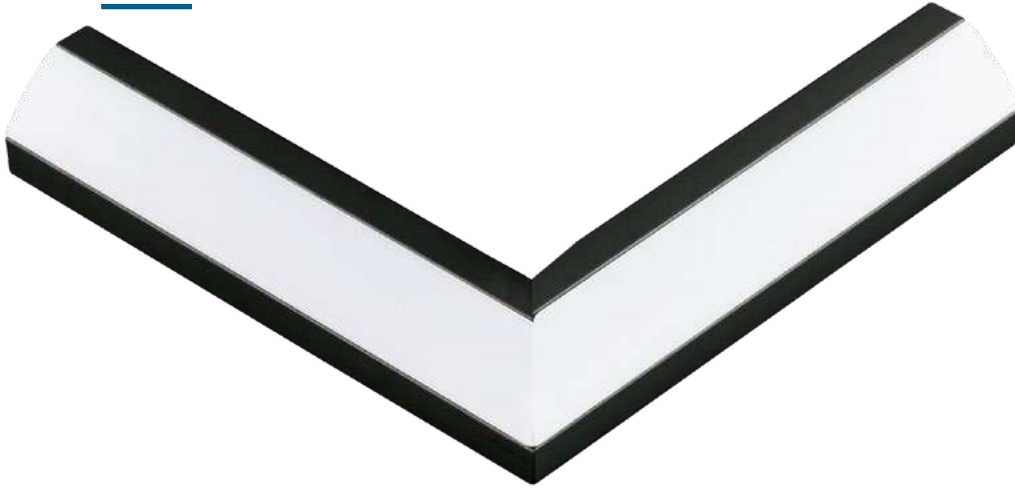

**98966 CORNER PROFILE 2**

accessory; aluminium, anodised black  
Zubehör; Alu, schwarz eloxiert  
accessoire; aluminium, noir anodisé

L 110



9 002759 989668

**PROFILE CROSS-SECTION /**  
Profilquerschnitt / section de profil

98963 98965  
98964 98966

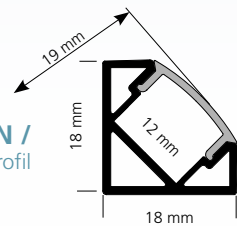



**INCLUDED IN DELIVERY /**  
im Lieferumfang enthalten /  
inclus dans la livraison



98967  
98968



98971  
98972



98974  
98975

**98967 SURFACE PROFILE 4**

accessory; aluminium, aluminium / plastic, satined  
Zubehör; Alu, alu / Kunststoff, satiniert  
accessoire; aluminium, aluminium / plastique, satiné

L 1000, B 18, H 48



9 002759 989675

**98968 SURFACE PROFILE 4**

accessory; aluminium, aluminium / plastic, satined  
Zubehör; Alu, alu / Kunststoff, satiniert  
accessoire; aluminium, aluminium / plastique, satiné

L 2000, B 18, H 48



9 002759 989682

**98971 SURFACE PROFILE 4**

accessory; aluminium, white / plastic, satined  
Zubehör; Alu, weiss / Kunststoff, satiniert  
accessoire; aluminium, blanc / plastique, satiné

L 1000, B 18, H 48



9 002759 989712

# WALL CONSTRUCTION PROFILES

incl. end caps & mounting clips



**98972**



**98974**

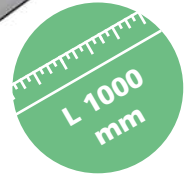

**98975**

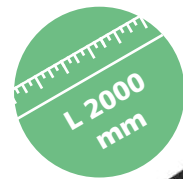

**98972 SURFACE PROFILE 4**

accessory; aluminium, white / plastic, satined  
 Zubehör; Alu, weiss / Kunststoff, satiniert  
 accessoire; aluminium, blanc / plastique, satiné

L 2000, B 18, H 48



9 002759 989729

**98974 SURFACE PROFILE 4**

accessory; aluminium, black / plastic, satined  
 Zubehör; Alu, schwarz / Kunststoff, satiniert  
 accessoire; aluminium, noir / plastique, satiné

L 1000, B 18, H 48



9 002759 989743

**98975 SURFACE PROFILE 4**

accessory; aluminium, black / plastic, satined  
 Zubehör; Alu, schwarz / Kunststoff, satiniert  
 accessoire; aluminium, noir / plastique, satiné

L 2000, B 18, H 48



9 002759 989750

**PROFILE CROSS-SECTION /**  
 Profilquerschnitt / section de profil

98967 98971 98974  
 98968 98972 98975

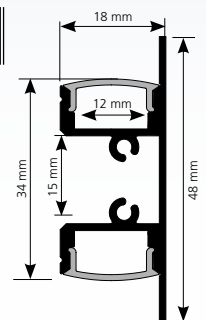

INCLUDED IN DELIVERY /  
im Lieferumfang enthalten /  
inclus dans la livraison



98977  
98978



98981  
98982



98977

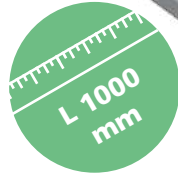

98978

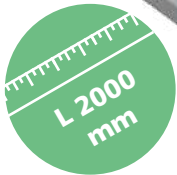

98979

### 98977 RECESSED PROFILE 1

accessory; aluminium, aluminium / plastic, white  
Zubehör; Alu, alu / Kunststoff, weiss  
accessoire; aluminium, aluminium / plastique, blanc

L 1000, B 23, H 9



9 002759 989774

### 98978 RECESSED PROFILE 1

accessory; aluminium, aluminium / plastic, white  
Zubehör; Alu, alu / Kunststoff, weiss  
accessoire; aluminium, aluminium / plastique, blanc

L 2000, B 23, H 9



9 002759 989781

### 98979 RECESSED PROFILE 1

accessory; aluminium, aluminium  
Zubehör; Alu, alu  
accessoire; aluminium, aluminium

L 110



9 002759 989798

## INSTALLATION PROFILES

incl. end caps & mounting clips



**98981**

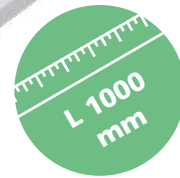

L 1000  
mm

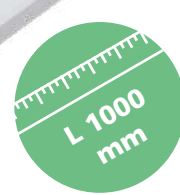

**98982**



L 2000  
mm



**98983**

### 98981 RECESSED PROFILE 1

accessory; aluminium, white / plastic, white  
Zubehör; Alu, weiss / Kunststoff, weiss  
accessoire; aluminium, blanc / plastique, blanc

L 1000, B 23, H 9



9 002759 989811

### 98982 RECESSED PROFILE 1

accessory; aluminium, white / plastic, white  
Zubehör; Alu, weiss / Kunststoff, weiss  
accessoire; aluminium, blanc / plastique, blanc

L 2000, B 23, H 9



9 002759 989828

### 98983 RECESSED PROFILE 1

accessory; aluminium, white  
Zubehör; Alu, weiss  
accessoire; aluminium, blanc

L 110



9 002759 989835

### PROFILE CROSS-SECTION / Profilquerschnitt / section de profil

98977 98979 98982  
98978 98981 98983

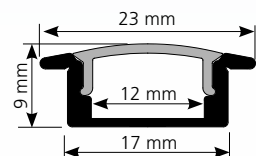



INCLUDED IN DELIVERY /  
im Lieferumfang enthalten /  
inclus dans la livraison

98984  
98985

98987  
98988

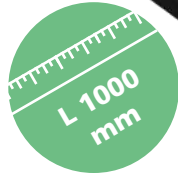

**98984**

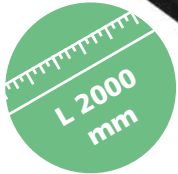

**98985**

**98986**

**98984 RECESSED PROFILE 1**

accessory; aluminium, black / plastic, white  
Zubehör; Alu, schwarz / Kunststoff, weiss  
accessoire; aluminium, noir / plastique, blanc

L 1000, B 23, H 9



9 002759 989842

**98985 RECESSED PROFILE 1**

accessory; aluminium, black / plastic, white  
Zubehör; Alu, schwarz / Kunststoff, weiss  
accessoire; aluminium, noir / plastique, blanc

L 2000, B 23, H 9



9 002759 989859

**98986 RECESSED PROFILE 1**

accessory; aluminium, anodised black  
Zubehör; Alu, schwarz eloxiert  
accessoire; aluminium, noir anodisé

L 110



9 002759 989866

**INSTALLATION PROFILES**

incl. end caps

**PROFILE CROSS-SECTION /**  
Profilquerschnitt / section de profil

98984 98986  
98985

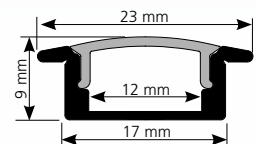



**98987**

L 1000  
mm

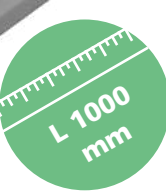
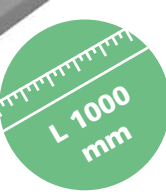

**98988**

L 2000  
mm

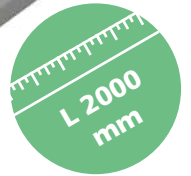

**98989**

**98987 RECESSED PROFILE 2**

accessory; aluminium, aluminium / plastic, white  
Zubehör; Alu, alu / Kunststoff, weiss  
accessoire; aluminium, aluminium / plastique, blanc

L 1000, B 23, H 15



9 002759 989873

**98988 RECESSED PROFILE 2**

accessory; aluminium, aluminium / plastic, white  
Zubehör; Alu, alu / Kunststoff, weiss  
accessoire; aluminium, aluminium / plastique, blanc

L 2000, B 23, H 15



9 002759 989880

**98989 RECESSED PROFILE 2**

accessory; aluminium, aluminium  
Zubehör; Alu, alu  
accessoire; aluminium, aluminium

L 110



9 002759 989897

**PROFILE CROSS-SECTION /**  
Profilquerschnitt / section de profil

98987 98989  
98988

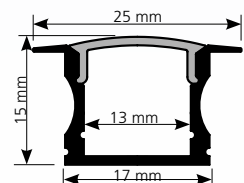

**INCLUDED IN DELIVERY /**

im Lieferumfang enthalten /  
inclus dans la livraison



98991  
98992



98994  
98995

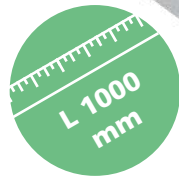

**98991**

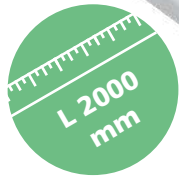

**98992**



**98993**

### **98991 RECESSED PROFILE 2**

accessory; aluminium, white / plastic, white  
Zubehör; Alu, weiss / Kunststoff, weiss  
accessoire; aluminium, blanc / plastique, blanc

L 1000, B 23, H 15



9 002759 989910

### **98992 RECESSED PROFILE 2**

accessory; aluminium, white / plastic, white  
Zubehör; Alu, weiss / Kunststoff, weiss  
accessoire; aluminium, blanc / plastique, blanc

L 2000, B 23, H 15



9 002759 989927

### **98993 RECESSED PROFILE 2**

accessory; aluminium, white  
Zubehör; Alu, weiss  
accessoire; aluminium, blanc

L 110



9 002759 989934

# INSTALLATION PROFILES

incl. end caps

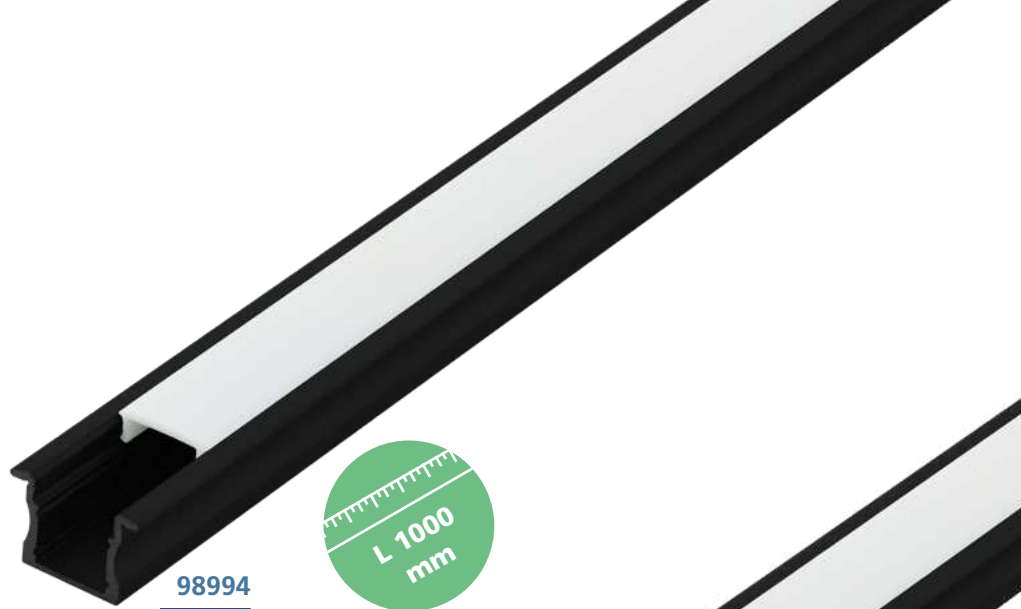

L 1000  
mm

98994



L 2000  
mm

98995



98996

### 98994 RECESSED PROFILE 2

accessory; aluminium, black / plastic, white  
Zubehör; Alu, schwarz / Kunststoff, weiss  
accessoire; aluminium, noir / plastique, blanc

L 1000, B 23, H 15



### 98995 RECESSED PROFILE 2

accessory; aluminium, black / plastic, white  
Zubehör; Alu, schwarz / Kunststoff, weiss  
accessoire; aluminium, noir / plastique, blanc

L 2000, B 23, H 15



### 98996 RECESSED PROFILE 2

accessory; aluminium, anodised black  
Zubehör; Alu, schwarz eloxiert  
accessoire; aluminium, noir anodisé

L 110



### PROFILE CROSS-SECTION / Profilquerschnitt / section de profil

98991 98993 98995  
98992 98994 98996

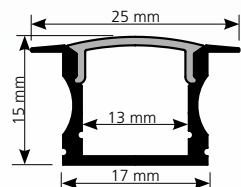

INCLUDED IN DELIVERY /  
im Lieferumfang enthalten /  
inclus dans la livraison



98997  
98998

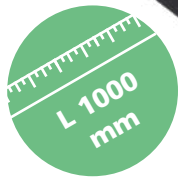

**98997**

**98998**



### 98997 SURFACE PROFILE 5

accessory; aluminium, black / plastic, white  
Zubehör; Alu, schwarz / Kunststoff, weiss  
accessoire; aluminium, noir / plastique, blanc

### 98998 SURFACE PROFILE 5

accessory; aluminium, black / plastic, white  
Zubehör; Alu, schwarz / Kunststoff, weiss  
accessoire; aluminium, noir / plastique, blanc

L 1000, B 80, H 50



9 002759 989972

L 2000, B 80, H 50



9 002759 989989

### PROFILE CROSS-SECTION / Profilquerschnitt / section de profil

98997 98998

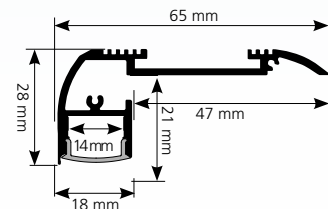

# STAIR PROFILES

incl. end caps







INCLUDED IN DELIVERY /  
im Lieferumfang enthalten /  
inclus dans la livraison



99004  
99005



99003  
99002



98999  
99001



L 2000  
mm

**99003**



L 1000  
mm

**99002**



L 2000  
mm

**99005**

### 99003 RECESSED PROFILE 3

accessory; aluminium, white / plastic, white  
Zubehör; Alu, weiss / Kunststoff, weiss  
accessoire; aluminium, blanc / plastique, blanc

L 2000, B 65, H 45



9 002759 990039

### 99002 RECESSED PROFILE 3

accessory; aluminium, white / plastic, white  
Zubehör; Alu, weiss / Kunststoff, weiss  
accessoire; aluminium, blanc / plastique, blanc

L 1000, B 65, H 45



9 002759 990022

### 99005 RECESSED PROFILE 3

accessory; aluminium, black / plastic, white  
Zubehör; Alu, schwarz / Kunststoff, weiss  
accessoire; aluminium, noir / plastique, blanc

L 2000, B 65, H 45



9 002759 990053

# INSTALLATION PROFILES LARGE

incl. end caps

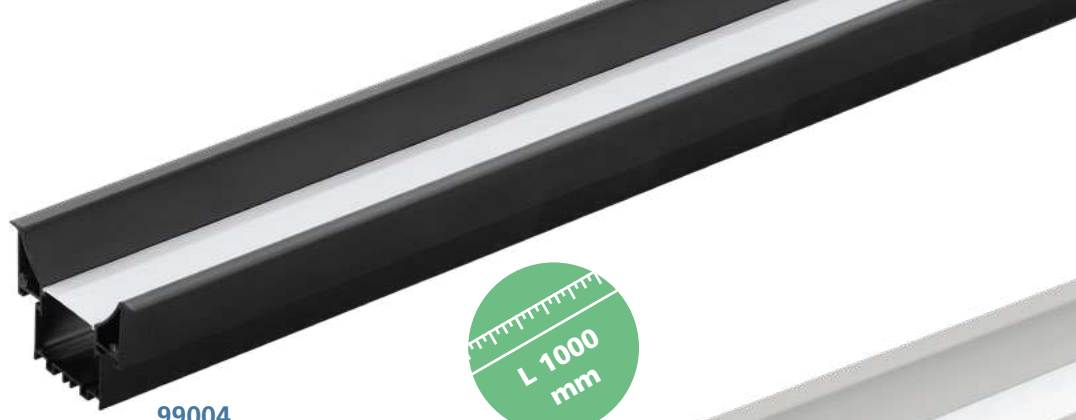

**99004**



**98999**



**99001**

### 99004 RECESSED PROFILE 3

accessory; aluminium, black / plastic, white  
Zubehör; Alu, schwarz / Kunststoff, weiss  
accessoire; aluminium, noir / plastique, blanc

L 1000, B 65, H 45



9 002759 990046

### 98999 RECESSED PROFILE 3

accessory; aluminium, aluminium / plastic, white  
Zubehör; Alu, alu / Kunststoff, weiss  
accessoire; aluminium, aluminium / plastique, blanc

L 1000, B 65, H 45



9 002759 989996

### 99001 RECESSED PROFILE 3

accessory; aluminium, aluminium / plastic, white  
Zubehör; Alu, alu / Kunststoff, weiss  
accessoire; aluminium, aluminium / plastique, blanc

L 2000, B 65, H 45



9 002759 990015

### PROFILE CROSS-SECTION / Profilquerschnitt / section de profil

98999 99002 99004  
99001 99003 99005

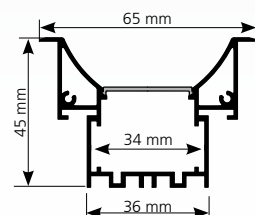

INCLUDED IN DELIVERY /  
im Lieferumfang enthalten /  
inclus dans la livraison



99006  
99007



99008  
99009



99011  
99012



**99006**

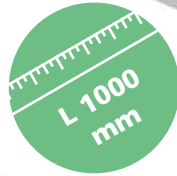

**99007**

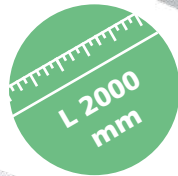

**99008**

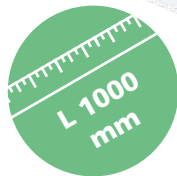

### 99006 SURFACE PROFILE 6

accessory; aluminium, aluminium / plastic, white  
Zubehör; Alu, alu / Kunststoff, weiss  
accessoire; aluminium, aluminium / plastique, blanc

L 1000, B 35, H 45



9 002759 990060

### 99007 SURFACE PROFILE 6

accessory; aluminium, aluminium / plastic, white  
Zubehör; Alu, alu / Kunststoff, weiss  
accessoire; aluminium, aluminium / plastique, blanc

L 2000, B 35, H 45



9 002759 990077

### 99008 SURFACE PROFILE 6

accessory; aluminium, white / plastic, white  
Zubehör; Alu, weiss / Kunststoff, weiss  
accessoire; aluminium, blanc / plastique, blanc

L 1000, B 35, H 45



9 002759 990084

# INSTALLATION PROFILES LARGE

incl. end caps



### 99009 SURFACE PROFILE 6

accessory; aluminium, white / plastic, white  
Zubehör; Alu, weiss / Kunststoff, weiss  
accessoire; aluminium, blanc / plastique, blanc

L 2000, B 35, H 45



### 99011 SURFACE PROFILE 6

accessory; aluminium, black / plastic, white  
Zubehör; Alu, schwarz / Kunststoff, weiss  
accessoire; aluminium, noir / plastique, blanc

L 1000, B 35, H 45



### 99012 SURFACE PROFILE 6

accessory; aluminium, black / plastic, white  
Zubehör; Alu, schwarz / Kunststoff, weiss  
accessoire; aluminium, noir / plastique, blanc

L 2000, B 35, H 45



### PROFILE CROSS-SECTION / Profilquerschnitt / section de profil

99006 99008 99011  
99007 99009 99012

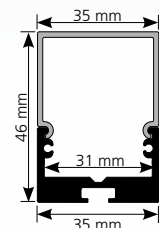



**99495**



**99496**



**99497**

#### **99495 RECESSED PROFILE 4**

accessory; aluminium, aluminium / plastic, white  
Zubehör; Alu, alu / Kunststoff, weiss  
accessoire; aluminium, aluminium / plastique, blanc

L 1000, B 62, H 14



9 002759 994952

#### **99496 RECESSED PROFILE 4**

accessory; aluminium, aluminium / plastic, white  
Zubehör; Alu, alu / Kunststoff, weiss  
accessoire; aluminium, aluminium / plastique, blanc

L 2000, B 62, H 14



9 002759 994969

#### **99497 RECESSED PROFILE 4**

accessory; aluminium, black / plastic, white  
Zubehör; Alu, schwarz / Kunststoff, weiss  
accessoire; aluminium, noir / plastique, blanc

L 1000, B 62, H 14



9 002759 994976

## TILE PROFILE



99498



#### 99498 RECESSED PROFILE 4

accessory; aluminium, black / plastic, white  
 Zubehör; Alu, schwarz / Kunststoff, weiss  
 accessoire; aluminium, noir / plastique, blanc

L 2000, B 62, H 14



9 002759 994983

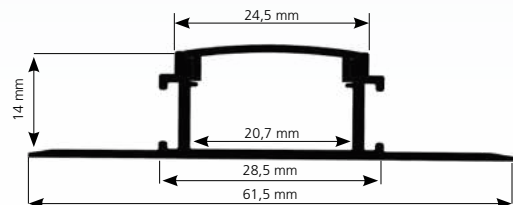

99495 99497  
 99496 99498





#### 99502 RECESSED PROFILE 4

accessory; aluminium, black / plastic, white  
Zubehör; Alu, schwarz / Kunststoff, weiss  
accessoire; aluminium, noir / plastique, blanc

L 1000, B 13, H 13



#### 99503 RECESSED PROFILE 4

accessory; aluminium, black / plastic, white  
Zubehör; Alu, schwarz / Kunststoff, weiss  
accessoire; aluminium, noir / plastique, blanc

L 2000, B 13, H 13



#### 99499 RECESSED PROFILE 4

accessory; aluminium, aluminium / plastic, white  
Zubehör; Alu, alu / Kunststoff, weiss  
accessoire; aluminium, aluminium / plastique, blanc

L 1000, B 13, H 13



## TILE PROFILE FINISHING BOARD



99501



### 99501 RECESSED PROFILE 4

accessory; aluminium, aluminium / plastic, white  
 Zubehör; Alu, alu / Kunststoff, weiss  
 accessoire; aluminium, aluminium / plastique, blanc

L 2000, B 13, H 13

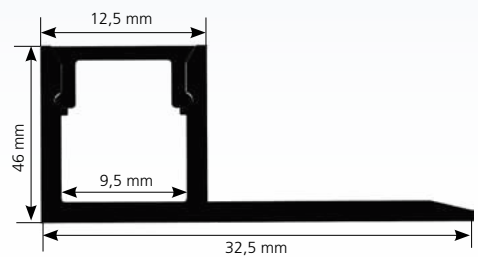

99499 99502  
 99501 99503

# EGLO WORLDWIDE

EGLO WELTWEIT

EGLO DANS LE MONDE



 **HEADQUARTERS**  
EGLO LEUCHTEN GMBH  
Heiligkreuz 22  
A-6136 PILL  
T: +43 5242 6996 0 | F: +43 5242 6996 972  
E: info-austria@eglo.com

 **AUSTRALIA**  
EGLO LIGHTING AUSTRALIA  
5/339 Archerfield Road  
Richlands | Queensland 4077  
T: +61 7 3375 1413 | F: +61 7 3375 1412  
E: info-australia@eglo.com

 **BELGIUM**  
EGLO BELGIUM B.V.B.A.  
Antwerpsesteenweg 247 | B-2950 Kapellen  
Visit Adress: Innovatiepark 20 |  
4906 AA OOSTERHOUT (NL)  
T: +32 3 250 60 80 | F: +32 3 219 80 67  
E: info-belgium@eglo.com

 **BOSNIA-HERZEGOVINA**  
EGLO RASVJETA BH D.O.O.  
Ormanica bb  
BIH-76250 GRADACAC  
T: +387 35 86 85 00 | F: +387 35 82 44 41  
E: Info-Bosnia-Herzegovina@eglo.com

 **BULGARIA**  
EGLO BULGARIA EOOD  
Main Road Burgas-Sofia, 5th kilometer,  
Building KACHIKA, 8000 BOURGAS, Bulgaria  
T: +359 56 960 403 | F: +359 56 53 05 95  
E: info-bulgaria@eglo.com

 **CANADA**  
EGLO CANADA INC.  
20700 Route Transcanadienne  
Baie-D'Urfé, Québec | H9X 4B7  
T: +1 514 457 5483 | F: +1 514 457 5487  
E: info-canada@eglo.com

 **CHILE - SANTIAGO**  
EGLO CHILE ILUMINACION LTDA.  
Av. Américo Vespucio 1930  
Conchalí - SANTIAGO DE CHILE  
T: +562 2 595 2222  
E: info-chile@eglo.com

 **CHINA**  
DONGGUAN EGLO CHINA LIGHTING CO., LTD.  
No.1 | Shangqiao Industrial Road | Shangqiao,  
Dongcheng District  
DONGGUAN CITY, GUANZHOU PROVINCE | CHINA  
T: +86 769 2203 3866 | F: +86 769 2203 6866  
E: info-china@eglo.com

 **COLOMBIA**  
EGLO COLOMBIA ILUMINACION SAS  
AUTOPISTA NORTE KM 19 COSTADO LOTE 30  
BOGOTÁ - CHIA  
T: +57 (1) 744 2339  
E: info-global@eglo.com

 **COSTA RICA**  
EGLO Costa Rica, Centro Comercial Calle Real local #8  
Guachipilín de Escazú de la sucursal del BAC  
San Jose 800 metros al norte San Jose Costa Rica.  
T: +506-2289-4690, +506-2100-6384  
E: Info-CostaRica@eglo.com

 **CROATIA**  
EGLO RASVJETA D.O.O.  
Jadranska avenija 9  
HR-10020 Zagreb  
T: +385 1 379 40 62 | F: +385 1 379 41 04  
E: info-croatia@eglo.com

 **CZECH REPUBLIC**  
EGLO CZ+SK s.r.o.  
Náhodská 2479/63  
CZ-193 00 PRAHA 9 Horní Počernice  
T: +420 281 924 163 | F: +420 281 925 205  
E: info-czechrepublic@eglo.com

 **DENMARK**  
EGLO DANMARK A/S  
Agerbakken 20  
DK-8362 Hørning  
T: +45 70 22 55 11 | F: +45 70 22 55 21  
E: info-denmark@eglo.com

 **ESTONIA**  
MOODNE VALGUSTUS AS  
Rävala pst. 7  
EE-10143 TALLINN  
T: +372 667 6670 | F: +372 631 3195  
E: info-global@eglo.com

 **FINLAND**  
EGLO FINLAND OY  
Malmiraitti 17A  
00700 Helsinki  
T: +358 20 7649 820 | F: +358 20 7649 821  
E: info-finland@eglo.com

 **FRANCE**  
EGLO FRANCE LUMINAIRE SARL  
Z.A. Jeune Bois | 2 Rue de la Martinique  
F-68274 WITTENHEIM  
T: +33 389 6250 30 | F: +33 389 6250 49  
E: info-france@eglo.com

 **GERMANY**  
EGLO LEUCHTEN HANDELS GMBH  
Kleinbahnstr. 35  
D-59759 ARNSBERG  
T: +49 2932 6269 0 | F: +49 2932 6269 39  
E: info-germany@eglo.com

 **GREECE**  
EGLO HELLAS A.E.  
Sykias 2 and parodos dekeleias  
ACHARNAI, GR-13679  
T: +30 210 240 77 10 | F: +30 210 240 07 29  
E: info-greece@eglo.com



**GREAT BRITAIN**  
EGLO UK LTD.  
Unit 12 Cirrus Park, Lower Farm Road, Moulton Park  
Industrial Estate, NORTHAMPTON NN3 6UR  
T: +44 1604 790 986 | F: +44 1604 670 282  
E: info-greatbritain@eglo.com



**MOROCCO**  
EGLO AFRICA  
219 Bd Med Zerkouni. Suite: 67  
20330 CASABLANCA | Morocco  
T: +212 522 98 80 25 / 05  
E: info-global@eglo.com / info.africa@eglo.com



**SPAIN**  
EGLO ESPANA ILUMINACION S.L.  
Avda. de Castilla 1 (Edf. Best Point) 2º-16A  
San Fernando de Henares, E-28830 MADRID  
T: +34 91 677 9044 | F: +34 91 677 0304  
E: info-spain@eglo.com



**HUNGARY - PRODUCTION & LOGISTICS**  
EGLO MAGYARORSZAG KFT.  
Fő út. 155  
H-3060 PASZTO  
T: + 36 32 560 050 | F: +36 32 560 040  
E: info-hungary@eglo.com



**THE NETHERLANDS**  
EGLO VERLICHTING NEDERLAND B.V.  
Innovatiepark 20  
4906 AA OOSTERHOUT (NBR)  
T: +31 162 48 28 30 | F: +31 162 48 28 40  
E: info-netherlands@eglo.com



**SWEDEN**  
EGLO SVERIGE AB  
Star Street 1  
SE-512 50 SVENLJUNGA  
T: +46 340 623 505 | F: +46 340 623 605  
E: info-sweden@eglo.com



**INDIA**  
EGLO INDIA PRIVATE LIMITED  
A-307 Ansal Chamber-1, 3 Bhikaji Cama Place,  
New Delhi-110066  
T: +91 981 108 2205 | T: +91 999 961 0450  
E: info-india@eglo.com



**NORWAY**  
MS Belysning AS  
Heiaveien 4  
NO-1900 FETSUND  
T: +47 63 888500 | F: +47 63 888501  
E: info-norway@eglo.com



**SWITZERLAND**  
EGLO SCHWEIZ AG  
Seetalstraße 142  
CH-6032 EMMEN  
T: +41 41 268 69 59 | F: +41 41 268 69 58  
E: info-switzerland@eglo.com



**ITALY**  
EGLO ITALIANA S.R.L.  
Via Giotto, 4  
I-31021 MOGLIANO VENETO (TV)  
T: +39 041 45 66 232/245/251 | F: +39 041 45 74 066/071  
E: info-italy@eglo.com



**PERU**  
EGLO PERU S.A.C  
Avda. Santa Cruz No. 458 Distrito de San Isidro  
Provincia y Departamento Lima, San Isidro - Lima  
T: +51 1 4212 158  
E: info-peru@eglo.com



**TURKEY**  
Eglo Aydınlatma ithalat ihracat Ltd. Şti.  
Eyüp Sultan Mah. Sekmen Cad. No:18/2  
34855 SAMANDIRA, SANCaktepe / İSTANBUL  
T: +90 216 311 09 -02 / -03 / -04 | F: +90 216 311 09 -05  
E: info-turkey@eglo.com



**KAZAKHSTAN**  
EGLO KAZAKHSTAN LLP  
Office 72, 14<sup>th</sup> floor, Block 4A, Nurlı-Tau Business Centr,  
Al-Farabi Avenue 7, 050059 Almaty, Kazakhstan  
T: +7 727 293 25 20 | M: +7 701 031 00 00  
E: info-kazakhstan@eglo.com



**POLAND**  
EGLO POLSKA SP. Z.O.O.  
Ul. Pulawska 479  
02-844 WARSZAWA  
T: +48 22 644 57 55 | F: +48 22 644 89 82  
E: info-poland@eglo.com



**USA**  
EGLO USA, INC.  
3640 Royal South Parkway  
ATLANTA, GEORGIA 30349  
T: +1 404 477 5601 | F: +1 404 393 7053  
E: info-usa@eglo.com



**KOSOVO**  
EGLO KOSOVO LLC  
Lugisht e qytetit pn  
20000 PRIZREN- KOSOVO  
T: +377 44 2166 87 | Shop: +381 29 2442 84  
E: info-kosovo@eglo.com



**PORTUGAL**  
EGLO PORTUGAL ILUMINAÇÃO, LDA  
Rua Fonte Parada, 125  
PT-4595-434 SEROA-PAÇOS DE FERREIRA  
T: +351 255 890 000 | F: +351 255 892 346  
E: info-portugal@eglo.com



**UKRAINE**  
EGLO UKRAINE LTD  
bulv. Vatslav Havel 6/7A  
UA-03680 KIEV  
T: +38 044 463 98 41 | F: +38 044 468 84 67  
E: info-ukraine@eglo.com



**LITHUANIA**  
MOODNE VALGUSTUS AS  
Rāvāla pst. 7  
EE-10143 TALLINN  
T: +370 652 49923 | T: +372 667 6670  
E: info-lithuania@eglo.com



**ROMANIA**  
EGLO ROMANIA PRODEXIM SRL.  
Str. Atomistilor nr. 1D  
R-077125 MAGURELE - ILFOV - ROMANIA  
T: +40 314 250 902 | F: +40 314 250 899  
E: info-romania@eglo.com



**MAGYARORSZÁG – ÉRTÉKESÍTÉS**  
EGLO LUX KFT.  
Fő út. 143/A  
H-2120 DUNAKESZI  
T: +36 27 341 353 | F: +36 27 341 409  
E: info-hungary@eglo.com



**RUSSIA**  
EGLO LIGHTING LLC  
Varshavskoe shosse 35 | Building 1  
RU-117105 | MOSCOW  
T: +7495 789 4311 | F: +7495 789 4312  
E: info-russia@eglo.com



**MALAYSIA**  
EGLO ASIA SDN BHD  
No. 13, Jalan Pelukis U1/46B, Temasya 18, Glenmarie,  
40150 Shah Alam, Selangor Darul Ehsan, Malaysia  
T: +6011 1050 2336 | F: +603 5567 9415  
E: info-malaysia@eglo.com



**SERBIA**  
EGLO RASVETA DOO  
Stefana Privoćenog 28  
11000 BEOGRAD | SRBIJA  
T: +381 11 3981 366 | F: +381 11 3981 389  
E: info-serbia@eglo.com



**MEXICO**  
EGLO MÉXICO ILUMINACIÓN S DE RL DE CV  
Prolongación Avenida López Mateos Sur N°3561,  
Fraccionamiento Los Gavilanes.  
C.P. 45645, Tlajomulco de Zúñiga, Jalisco, México  
T: +52 33 3687 20 95 | E: info-mexico@eglo.com



**SLOVAKIA**  
EGLO CZ+SK s.r.o  
Náchodská 2479/63  
CZ-193 00 PRAHA 9 Horní Počernice  
T: +421 313 211 551 | F: +421 313 211 556  
E: info-slovakia@eglo.com



**MIDDLE EAST**  
EGLO LIGHTING MIDDLE EAST FZE  
P.O. BOX 262073, LOB 6, OFFICE G18  
JEBEL ALI, DUBAI, UAE  
T: +97 148810080 | F: +97 148810081  
E: info.me@eglo.com



**SLOVENIA**  
EGLO RASVJETA D.O.O.  
Jadranska avenija 9  
HR-10020 Zagreb  
T: +386 158 093 18  
E: info-slovenia@eglo.com

# HOW TO READ

ERKLÄRUNG  
COMMENT LIRE

## DIMENSIONS DIMENSIONEN DIMENSIONS

all dimensions in mm | alle Größen in mm | toutes dimensions en mm

L = length | Länge | longueur

B = width | Breite | largeur

H = height | Höhe | hauteur

Ø = diameter | Durchmesser | diamètre

A = projection length | Ausladung | amplitude

ET = installation depth | Einbautiefe | profondeur utile

Base = base dimensions | Sockelmaße | dimensions de base

Attention! The dimensions relate solely to the sizes of the luminaire. Any air spaces that would be relevant for a safe operating of the lamp were not considered.

Achtung! Die Größen beziehen sich nur auf die Abmessungen der Leuchte. Etwaige Lufträume, die für einen sicheren Betrieb der Leuchte notwendig sind, werden nicht berücksichtigt.

Attention! Les dimensions se réfèrent à la taille de la lampe seulement. Espacements éventuels, que seraient importants pour une opération de la lampe sans danger, n'ont pas été considérés.

## BUTTONS BUTTONS BOUTONS

Bulb included | Leuchtmittel inkludiert | ampoules inclus



Recessed Luminaire | Einbauleuchte | luminaire encastrable



Surface Luminaire | Aufbauleuchte | luminaire en saillie



**94406 PENETO**  
recessed light; steel, white  
Einbauleuchte; Stahl, weiss  
luminaire encastrable; acier, blanc

Ø 87, ET 115

400lm

9 002759 944063

Ø 87

**94408 PENETO**  
recessed light; steel, satin nickel  
Einbauleuchte; Stahl, nickel-matt  
luminaire encastrable; acier, nickel mat

Ø 87, ET 115

400lm

9 002759 944087

Ø 87

**94407 PENETO**  
recessed light; steel, chrome  
Einbauleuchte; Stahl, chrom  
luminaire encastrable; acier, chrome

Ø 87, ET 115

400lm

9 002759 944070

Ø 87

RECESSED LUMINAIRES - WITH BULBS  
209

ARTICLE NUMBER  
ARTIKELNUMMER  
NUMÉRO D'ARTICLE



**31682**  
LED



**31683**  
LED



**31689**  
LED

SPARE PARTS  
ERSATZTEILE  
PARTS DE REMPLACEMENT

If spare parts for product are available they are marked on the photograph with their corresponding article number.

Wenn zu einem Produkt Ersatzteile vorhanden sind, werden diese in der Abbildung mit der entsprechenden Artikelnummer markiert.

Si un produit a des parts de remplacement, elles sont marquées avec le numéro d'article dans la photo.

DESCRIPTION  
BESCHREIBUNG  
DESCRIPTION

The product description is composed as follows:  
luminaire type; enclosure material, enclosure colour / glass or shade material, glass or shade colour

Die Produktbeschreibung setzt sich wie folgt zusammen:  
Leuchtenart; Gehäusematerial, Gehäusefarbe / Schirm- bzw. Glasmaterial, Schirm- bzw. Glasfarbe

La description du produit est composée comme suit:  
type de luminaire; matériel de boîtier, couleur de boîtier / matériel de verre ou abat-jour, couleur de verre ou abat-jour

**31682 TEDO**  
recessed light; cast aluminium, white  
Einbauleuchte; Aluguss, weiss  
luminaire encastrable; fonte d'aluminium, blanc

**31683 TEDO**  
recessed light; cast aluminium, white  
Einbauleuchte; Aluguss, weiss  
luminaire encastrable; fonte d'aluminium, blanc

**31689 TEDO**  
recessed light; cast aluminium, satin nickel  
Einbauleuchte; Aluguss, nickel-matt  
luminaire encastrable; fonte d'aluminium, nickel mat



RECESSED LUMINAIRES - WITH BULBS  
210

PICTOGRAMMES  
PIKTOGRAMME  
PICTOGRAMMES

Technical details are represented as pictograms. An overview over all pictograms can be found on the next pages.

Technische Details werden als Piktogramme dargestellt. Eine Übersicht über alle Piktogramme finden Sie auf den nächsten Seiten.

Les détails techniques sont représentés sous forme de pictogrammes. Vous trouverez un aperçu de tous les pictogrammes dans les pages suivantes.

SKETCHES  
SKIZZEN  
CROQUIS

The sketches state the most meaningful dimensions. If a product is adjustable by will, a turquoise arrow marks this function and only the maximum dimensions are indicated.

Die Bemaßung der Skizzen umfasst jeweils die aussagekräftigsten Größen. Bei verstellbaren Produkten kennzeichnet ein türkiser Pfeil diese Funktion und nur die maximalen Größen werden angegeben.

Les dimensions des croquis comprennent les plus représentatives. Si un produit est réglable au choix, une flèche turquoise affiche cette fonction et rien que les dimensions maximales sont indiquées.



















SERIES NAME  
SERIENNAME  
NOM DE LA SÉRIE





























































# LEGEND

## PICTOGRAM PIKTOGRAMME PICTOGRAMME

### SOCKETS FASSUNGEN DOUILLES

 LED	 G4	 G53
 2G7	 G5	 GU5,3 / MR16
 2G11	 G9	 GU10
 2GX13	 G10Q	 GX53
 E14	 G13	 GY6,35
 E27	 G23	 R7s

### BULBS LEUCHTMITTEL AMPOULES

 E14 / C35	 E27 / A60 Halogen	 E27 / E140 Filament
 E14 / C35f	 E27 / R63 Halogen	 E27 / PS160 Filament
 E14 / D45	 E27 / A60 LED	 E27 / T30 Filament
 E14 / C35f LED	 E27 / A60 Filament	 E27 / T32 Filament
 E14 / D45 Halogen	 E27 / A65 LED	 G4 / T9
 E14 / C35 Halogen	 E27 / A75 Filament	 G4 / LT9
 E14 / T22	 E27 / G45 LED	 G4 / LT14
 E14 / C35 Filament	 E27 / G45 Filament	 G9
 E14 / C37 Filament	 E27 / G80 Filament	 G9 LED
 E14 / C35f Filament	 E27 / G95	 GU10
 E14 / C37f Filament	 E27 / G95 Filament	 GU10 LED
 E14 / P45 LED	 E27 / G125	 GU10 SMD LED
 E14 / P45 Filament	 E27 / G95 LED	 GX53 / LF75
 E14 / P50	 E27 / G200 Filament	<b>LED</b> LED board / LED Platine / LED bord
 E14 / ST48 Filament	 E27 / R63 LED	 MR16
 E14 / ST64 Filament	 E27 / ST48 Filament	 MR16 LED
 E14 / T20 LED	 E27 / ST64 Filament	 R7s / 78mm
 E27 / A60	 E27 / B80 Filament	 R7s / 118mm
 E27 / G90	 E27 / BR150 Filament	 R7s / 78mm LED
 E27 / QR63	 E27 / DP165 Filament	 R7s / 118mm LED

**LIGHT COLOUR & LUMEN**  
**LICHTFARBE & LUMEN**  
**COULEUR LUMINEUX & LUMEN**

The colours of the LED are represented as pictogrammes (see below), their luminous flux directly beneath. The luminous flux is quoted in lumen and describes the amount of light generated by the LED. The higher the value, the brighter is the lamp. Lumens are LED boards and are the light measurement value in bulbs.

Die Farben der LED werden als Piktogramm (siehe unten) dargestellt, deren Lichtstrom direkt darunter. Der Lichtstrom wird in Lumen gemessen und gibt die erzeugte Lichtmenge der LED an. Je höher der Wert, desto heller das Produkt. Lichtstromangaben (Lumen) sind Platinen- bzw. Leuchtmittelwerte.

Les couleurs de LED ont représentés sous forme de pictogrammes, leur flux lumineux directement en dessous. L'unité de flux lumineux est le lumen et il mesure la quantité de lumière générée par les LED. Plus la valeur est élevée, plus la lampe est lumineuse. Les lumens sont l'unité de mesure de l'intensité lumineuse des ampoules et des panneaux led intégrés.

	RGB RGB RGB
	RGB + white RGB + weiß RGB + blanc
	RGB + warmwhite RGB + warmweiß RGB + blanc chaud
	RGB + coldwhite RGB + kaltweiß RGB + blanc froid
	RGB + neutralwhite RGB + neutralweiß RGB + blanc neutrale

	RGB + tunable white RGB + tunable white RGB + tunable white
	tunable white tunable white tunable white
	warm white warmweiß blanc chaud
	cold white kaltweiß blanc froid
	neutral white neutralweiß blanc neutrale

**SWITCHES & SENSORS**  
**SCHALTER & SENSOREN**  
**INTERRUPTEUR & CAPTEURS**

	incl. cable & plug inkl. Kabel & Stecker câble & connecteur inclus
	internal dimmer eingebauter Dimmer variateur intégré
	button switch Druckknopf interrupteur de pression
	function switch Funktionsschalter interrupteur fonction
	rocker switch Wippschalter interrupteur à bascule
	pedal dimmer Trittdimmer variateur à pied

	pedal switch Trittschalter interrupteur à pied
	cable switch Kabelschalter interrupteur à câble
	incl. cable & plug transformer inkl. Kabel & Stecktransformator câble & transformateur à prise
	remote control Fernbedienung télécommande
	Day & Night Sensor Tag & Nacht Sensor sensor jour & nuit
	sensor Sensor sensor

	swedish plug Stecker Schweden connecteur swede
	"Touch me" ON/OFF "Touch me" EIN/AUS "Touch me" ON/OFF
	"Touch me" ON/OFF & dimm "Touch me" EIN/AUS & Dimmen "Touch me" ON/OFF & graduable
	pull switch Zugschalter interrupteur à bascule
	Timer - automatic on/off Zeitschaltuhr - automatisches Ein- & Ausschalten minuterie - peut être éteint et allumé automatiquement

**FUNKTIONS & COMFORT**  
**FUNKTIONEN & KOMFORT**  
**FONCTIONS & COMFORT**

	incl. battery inkl. Akku incl. pile
	incl. battery inkl. Batterie incl. pile
	battery specifications Batteriespezifikationen spécifications des piles
	beam angle Ausstrahlwinkel angle de rayonnement
	corner mount possible Eckmontage möglich montage en coin possible
	CRI Colour Rendering Index

	cutout (in mm) Ausschnitt (in mm) perçage du panneau (en mm)
	dimmable dimmbar mit externen Dimmer graduable
	not dimmable nicht dimmbar ne pas graduable
	Can be operated via control unit Bedienbar über Steuergerät Peut être commandé par une unité de contrôle
	replaceable LED austauschbare LED LED remplaçables
	loadable in kg belastbar in kg chargeable en kg

	packaging / delivery unit Verpackungs- / Liefereinheit unité d'emballage / de livraison
	shortable kürzbar réductible
	Voltage Volt Voltage
	Watt
	USB connection USB-Anschluss Connexion USB
	Qi-Charger

**PROTECTION CLASS**  
**SCHUTZKLASSE**  
**CLASSE DE PROTECTION**

The protection class indicates to what extent the lamp is protected against electric shock. All lamps in this catalogue are at least protected with the protection class 1 - a higher class is specified in the information box of the respective lamp.

Die Schutzklasse gibt an, inwiefern ein Produkt gegen einen elektrischen Schlag gesichert ist. Alle Leuchten in diesem Katalog sind mit mindestens Schutzklasse 1 gesichert, bei höheren Klassen wird das Symbol im Infokasten der Leuchte angegeben.

La classe de protection indique, dans quelle mesure la lampe est protégée contre les chocs électriques. Tous les lampes dans ce catalogue sont protégées au moins avec la classe 1 - une classe plus élevée est indiquée dans l'information de la lampe.

	protection class 1: protective earthing Schutzklasse 1: Schutzerdung classe de protection 1: prise de terre
--	---

	protection class 2: protective insulation Schutzklasse 2: Schutzisolation classe de protection 2: double isolation ou renforcée
--	---

	protection class 3: protective low voltage Schutzklasse 3: Schutzkleinspannung classe de protection 3: très basse tension de sécurité
--	---

**PROTECTION RATING**  
**SCHUTZGRAD**  
**INDICE DE PROTECTION**

The protection rating ensures the operational safety of luminaires. The first number specifies the extent of the protection against the ingress of foreign bodies; the second number identifies the humidity protection grade. All luminaires in this catalogue are at least protected with the rating IP20 - a higher rating is specified in the information box of the luminaire.

Der Schutzgrad gewährleistet die Betriebssicherheit von Leuchten. Die erste Ziffer des IP Grades beschreibt den Schutzzumfang gegen das Eindringen von Fremdkörpern, die zweite Ziffer informiert über den Grad des Feuchtigkeitsschutzes. Alle Leuchten in diesem Katalog sind mit mindestens Schutzgrad IP20 gesichert, bei höheren Graden wird das Symbol im Infokasten der Leuchte angegeben.

L'indice de protection assure la sécurité opérationnelle des luminaires. Le premier chiffre indique à quel point la protection est efficace contre l'insertion de corps étrangers; le second chiffre indique quant à lui le degré de protection par rapport à l'humidité. Tous les luminaires dans ce catalogue sont protégés au moins avec l'indice IP20 - un indice plus élevé est indiqué dans l'information d'article.

	IP33
	IP44

	IP54
	IP65

	IP67
--	------

# REGISTER

ARTICLE NUMBER

ARTIKELNUMMER

NUMÉROS D'ARTICLE

NUMBER NUMMER NUMÉRO	PAGE SEITE PAGE	NUMBER NUMMER NUMÉRO	PAGE SEITE PAGE	NUMBER NUMMER NUMÉRO	PAGE SEITE PAGE	NUMBER NUMMER NUMÉRO	PAGE SEITE PAGE	NUMBER NUMMER NUMÉRO	PAGE SEITE PAGE	NUMBER NUMMER NUMÉRO	PAGE SEITE PAGE	NUMBER NUMMER NUMÉRO	PAGE SEITE PAGE
30891	239	900099	28	95855	115	98209	53	98802	191	98911	270	98962	289
30892	238	900101	28	95856	115	98212	57	98803	191	98912	270	98963	290
30893	239	900102	28	95857	117	98238	130	98804	196	98913	270	98964	290
30894	239	900103	34	95858	117	98239	131	98805	197	98914	271	98965	290
31682	210	900104	34	95859	117	98241	130	98806	197	98915	271	98966	291
31683	210	900105	32	95887	134	98242	131	98807	197	98916	271	98967	292
31688	211	900106	32	95888	134	98243	122	98808	192	98917	272	98968	292
31689	210	900107	32	95889	134	98244	122	98809	192	98918	272	98971	292
32811	89	900108	38	95932	135	98246	123	98811	198	98919	272	98972	293
32812	88	900109	39	95962	135	98292	57	98812	198	98921	273	98974	293
32813	89	900111	30	96151	71	98293	57	98813	198	98922	273	98975	293
32896	120	900112	30	96152	70	98295	58	98814	200	98923	273	98977	294
33107	96	900113	30	96153	70	98296	58	98815	200	98924	274	98978	294
33108	96	900114	36	96154	70	98297	54	98816	200	98925	274	98979	294
33199	52	900115	36	96791	252	98301	126	98817	201	98926	274	98981	295
61355	72	91355	253	96792	252	98302	128	98818	201	98927	275	98982	295
61358	72	94235	207	96794	252	98303	126	98819	201	98928	275	98983	295
61359	73	94236	207	96901	136	98304	128	98821	190	98929	275	98984	296
61361	73	94237	207	96902	136	98305	127	98822	190	98931	276	98985	296
61489	72	94239	208	97029	265	98306	129	98823	190	98932	276	98986	296
900044	24	94406	209	97079	174	98307	127	98824	194	98933	276	98987	297
900045	24	94407	209	97262	240	98308	129	98825	194	98934	278	98988	297
900046	24	94408	209	97263	241	98418	90	98826	194	98935	278	98989	297
900047	25	94496	250	97264	242	98419	90	98827	195	98936	278	98991	298
900048	25	94497	250	97265	242	98471	124	98828	195	98937	277	98992	298
900049	26	94499	250	97266	241	98472	124	98829	195	98938	277	98993	298
900051	26	94501	248	97267	241	98473	124	98842	29	98939	277	98994	299
900052	26	94502	248	97268	243	98474	125	98843	35	98941	280	98995	299
900053	27	94503	249	97269	242	98475	78	98844	31	98942	280	98996	299
900054	18	94504	248	97271	240	98476	78	98845	36	98943	280	98997	300
900055	18	95357	212	97279	240	98477	78	98846	33	98944	281	98998	300
900056	18	95359	213	97501	94	98478	79	98847	38	98945	282	98999	303
900057	22	95817	132	97502	94	98479	79	98849	34	98946	282	99001	303
900058	22	95818	132	97503	94	98485	95	98852	37	98947	282	99002	302
900059	22	95819	132	97593	172	98521	170	98854	38	98948	283	99003	302
900061	23	95821	133	97594	172	98571	260	98865	166	98949	284	99004	303
900062	23	95822	133	97927	264	98572	260	98866	166	98951	284	99005	302
900086	40	95823	133	97928	264	98573	263	98867	166	98952	284	99006	304
900087	41	95843	118	98025	89	98574	263	98868	167	98953	285	99007	304
900088	40	95844	118	98129	88	98607	122	98869	167	98954	286	99008	304
900089	40	95846	118	98201	54	98609	126	98871	167	98955	286	99009	305
900091	42	95848	114	98203	54	98611	128	98901	80	98956	286	99011	305
900092	43	95851	116	98205	55	98637	206	98902	80	98957	287	99012	305
900093	42	95852	116	98206	55	98639	206	98903	80	98958	288	99038	66
900094	42	95853	116	98207	52	98641	212	98904	81	98959	288	99039	66
900095	27	95854	115	98208	52	98801	191	98905	81	98961	288	99061	204

NUMBER NUMMER NUMÉRO	PAGE SEITE PAGE	NUMBER NUMMER NUMÉRO	PAGE SEITE PAGE	NUMBER NUMMER NUMÉRO	PAGE SEITE PAGE	NUMBER NUMMER NUMÉRO	PAGE SEITE PAGE	NUMBER NUMMER NUMÉRO	PAGE SEITE PAGE
99062	204	99191	159	99253	229	99497	306	99755	186
99065	254	99192	159	99254	229	99498	307	99756	187
99066	254	99193	159	99255	230	99499	308	99757	184
99099	15	99202	160	99256	230	99501	309	99758	185
99131	140	99203	160	99257	230	99502	308	99759	185
99132	140	99204	162	99258	232	99503	308	99761	184
99133	140	99205	162	99259	232	99548	20	99762	187
99134	141	99206	160	99263	232	99549	20	99763	187
99135	141	99207	161	99264	233	99639	20	99833	84
99136	142	99208	162	99265	234	99643	137	99834	85
99137	142	99209	163	99266	234	99644	137	99835	85
99138	142	99211	164	99267	234	99669	17	99836	85
99139	143	99212	164	99268	236	99671	17	99841	67
99141	143	99213	164	99269	236	99672	17	99842	67
99142	144	99214	165	99271	236	99684	44	99843	82
99143	144	99215	217	99281	256	99685	45	99844	83
99144	144	99216	217	99282	256	99686	44	99845	83
99145	145	99217	217	99283	256	99687	44	99846	83
99146	145	99218	218	99284	257	99716	260		
99147	146	99219	218	99337	246	99717	261		
99148	146	99221	218	99338	246	99718	261		
99149	146	99222	219	99421	100	99719	261		
99151	147	99223	219	99422	100	99721	262		
99152	148	99224	219	99423	101	99722	262		
99153	148	99225	220	99424	101	99723	262		
99154	148	99226	220	99425	102	99724	264		
99155	149	99227	220	99426	102	99726	246		
99156	150	99228	221	99427	103	99727	247		
99157	150	99229	221	99428	103	99728	74		
99158	150	99232	221	99431	104	99729	74		
99159	151	99233	222	99432	104	99734	180		
99162	152	99234	222	99433	105	99735	180		
99163	152	99235	222	99434	105	99736	181		
99164	152	99236	224	99435	106	99737	180		
99167	153	99237	224	99436	106	99738	181		
99168	153	99238	224	99437	106	99739	181		
99169	153	99239	225	99471	107	99742	182		
99178	154	99241	225	99472	107	99743	182		
99179	154	99242	225	99473	107	99744	183		
99181	154	99243	226	99474	108	99745	182		
99183	155	99244	226	99475	108	99746	183		
99184	155	99245	226	99476	108	99747	183		
99185	155	99246	228	99493	130	99749	186		
99187	157	99247	228	99494	131	99751	186		
99188	157	99248	228	99495	306	99753	184		
99189	157	99252	229	99496	306	99754	185		

# REGISTER

SERIES NAMES  
SERIENNAMEN  
NOME DE PRODUITS

NAME NAME NOM	PAGE SEITE PAGE	NAME NAME NOM	PAGE SEITE PAGE	NAME NAME NOM	PAGE SEITE PAGE
ACCESS REMOTE	52	RECESSED PROFILE 3	302-303	TB CORTENOVA	184-185
ARETIO	206	RECESSED PROFILE 4	306-309	TB MIDDLE FEEDER	181,183
CHANGO	174	REMOTE 2.0	15	TB NEWTOWN	184
CORNER PROFILE 1	280-285	RONZANO 1	170	TB SERAS	186
CORNER PROFILE 2	286-291	ROVITO-Z	40-43	TB SET	187
CRESPILLO	246-247	SALABATE	130-131	TB SPOTLIGHT	186-187
FERREROS	252	SALICETO	122-129	TB TRACK L	180,182
FIOBBO	172	SALICETO-Z	17	TB TRACK S	180,182
FLEXIBLE STRIPE	260-264	SALOBRENA 1	70-73,88-89	TEDO	210-211
FUEVA 1	240-243	SALOBRENA-A	54-55	TEDO 1	212-213
FUEVA 5	140-155,157, 159-165,217-222, 224-226,228-230, 232-234,236, 238-239	SALOBRENA-F	100-105	TP BLIND COVER L	195
FUEVA FLEX	166-167	SALOBRENA-M	90	TP BLIND COVER S	194
FUEVA-A	57	SALOBRENA-RGBW	96	TP CANOPY	197
FUEVA-Z	28-39	SALOBRENA-Z	24-27	TP CUBE CONNECTOR	191
GRIMASOLA	256-257	SALUZZO	204,254	TP DOWNLIGHT	200
HERRORA-Z	20	SARSINA	94-95	TP LIGHT INSERT L	192
LAZARAS	67	SARSINA-A	52-53	TP LIGHT INSERT S	192
LED STRIPE-Z	44-45	SARTIANO	120	TP PENDANT LIGHT	198
LED STRIPES-FLEX	264	SAVATARILA	66	TP SPOTLIGHT	201
LED-STRIFE-A	58	SURFACE PROFILE 1	270-272	TP SUSPENSION	196
LOKE 1	253	SURFACE PROFILE 2	273-275	TP TRACK	190
MECINOS	137	SURFACE PROFILE 3	276-278	TURCONA	78-81
PENETO	207-209	SURFACE PROFILE 4	292-293	TURCONA-B	82-83
PIDIO	265	SURFACE PROFILE 5	300	TURCONA-CCT	84-85
PIGLIONASSO	106-108	SURFACE PROFILE 6	304-305	TURCONA-Z	18,22-23
PINEDA	114-118,132-134	TB ADAPTER	181,183	URTEBIETA	74
PINEDA 1	135	TB CASIBARE	184	ZARATE	136
POLASSO	248-250	TB CONNECTOR	180,182		
RECESSED PROFILE 1	294-296	TB CORNER CONNECT	181,183		
RECESSED PROFILE 2	297-299	TB CORTADERAS	185		





All previous catalogues and price lists are no longer valid with the issue of this catalogue. Errors, misprints, model and price changes and technical modifications are reserved. We deliver based on our terms of delivery and payment. Our products comply with the European light norm EN60598. Products with the ENEC test mark are conforming to the guide line 2006/95/EG. Products with additional safety remarks (e.g protection class, IP) are identified within the product family with the relevant symbol and number. The content of this catalogue is protected under copyright law for EGLO Leuchten GmbH. All rights reserved. Our specific written consent must be obtained before using any illustrations and texts. The pictures are 4C prints and may differ from the original.

The product pictures and ambiances in this catalogue can deviate from reality, and they do not necessarily concur with the usual application of the product. EGLO does not assume liability for the correctness, completeness or the application depiction of the products and/or the product information.

Design, layout and composition: EGLO GmbH, A-6136 Pöll - AUSTRIA  
Print: Gutenberg-Werbering Gesellschaft m.b.H., 4020 Linz - AUSTRIA  
Pictures: EGLO, Adobe Stock, istockphoto.com

---

Mit diesem Katalog verlieren alle vorhergehenden Kataloge und Preislisten ihre Gültigkeit. Irrtümer, Druckfehler, Modell- und Preisänderungen sowie technische Änderungen vorbehalten. Wir liefern zu unseren Liefer- und Zahlungsbedingungen. Unsere Produkte entsprechen der europäischen Leuchtnorm EN 60598. Produkte mit dem ENEC Prüfzeichen sind konform mit der Richtlinie 2006/95/EG. Produkte mit weiteren Sicherheitshinweisen (zB. Schutzklasse, IP) sind mit Symbol und Zahl bei der Produktfamilie ausgezeichnet. Der Inhalt dieses Kataloges ist für die EGLO Leuchten GmbH urheberrechtlich geschützt. Alle Rechte sind vorbehalten. Bilder und Texte dürfen nicht ohne vorherige ausdrückliche, schriftliche Genehmigung verwendet werden. Die Abbildungen sind 4C Drucke und können vom Original abweichen.

Die Katalogbilder und die gezeigten Darstellungen der Produkte können von der Wirklichkeit abweichen und nicht den üblichen Produktanwendungen entsprechen. EGLO übernimmt keine Haftung für die Richtigkeit, Vollständigkeit und Anwendungsdarstellung der Produkte und Produktinformationen.

Gestaltung, Layout und Satz: EGLO GmbH, A-6136 Pöll - AUSTRIA  
Druck: Gutenberg-Werbering Gesellschaft m.b.H., 4020 Linz - AUSTRIA  
Bilder: EGLO, Adobe Stock, istockphoto.com

---

Le présent catalogue remplace tous les catalogues et tarifs précédents. Sous réserve d'erreurs, de fautes d'impression, de modification des modèles et de changement de prix et de technique. Nous livrons sur la base de nos conditions de livraison et de paiement. Nos produits sont conformes aux normes européennes EN 60598 et portent le marquage CE. Les produits portant la marque ENEC sont conformes à la Directive 2006/95/EG. Les produits portant d'autres indications de sécurité (par exemple classe de protection, IP) sont identifiés par le symbole et le nombre correspondants dans la famille de produits.

Le contenu du présent catalogue est protégé pour la société EGLO Leuchten GmbH par un copyright. Tous droits réservés. Toute reproduction d'images et du texte est interdite sans autorisation explicite par écrit préalable. Les images sont imprimées en 4C et peuvent différer de l'original.

Les images des produits et les ambiances dans le catalogue peuvent dévier de la réalité et ne sont pas nécessairement en ligne avec l'usage habituel du produit. EGLO n'engage pas sa responsabilité sur la justesse des images et sur les informations relatives à l'usage pouvant être fait des produits.

Conception, maquette et composition: EGLO GmbH, A-6136 Pöll - AUSTRIA  
Presse: Gutenberg-Werbering Gesellschaft m.b.H., 4020 Linz - AUSTRIA  
Images: EGLO, Adobe Stock, istockphoto.com

06-2021





**EGLO**  
my light | my style

EGLO Leuchten GmbH  
Heiligkreuz 22  
A-6136 Pill  
Austria  
Tel. +43 (0) 5242 6996  
Fax +43 (0) 5242 6996-972  
info@eglo.com  
www.eglo.com

KATTL21

my light | my style