



**rabalux<sup>®</sup>**

**New Products  
2022**



# CONTENTS • TARTALOMJEGYZÉK • INHALTSVERZEICHNIS

**01**

## MODERN

Modern  
Modern

**3-11**

**02**

## INDUSTRIAL AND NORDIC

Indusztriális és skandináv  
Industrial und Skandinavisch

**12-17**

**03**

## SMART AND LED CEILING LAMPS

Okos és LED mennyezeti lámpák  
Smart und LED Deckenleuchten

**18-29**

**04**

## SPOTS, RECESSED AND SURFACE MOUNTED LIGHTING

Spotok, be- és ráépíthető lámpák  
Spots, Ein- und Aufbauleuchten

**30-37**

**05**

## FLOOR, TABLE LAMPS AND DECORATIVE LAMPS

Álló-, asztali lámpák és dekor lámpák  
Steh-, Tischlampen und Dekorleuchten

**38-45**

**06**

## DATA

Adatok  
Daten

**46-51**





**OI**

**MODERN**

**MODERN**

**MODERN**



# ACANTHA



5258

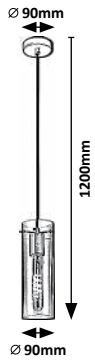

1200mm

∅ 90mm

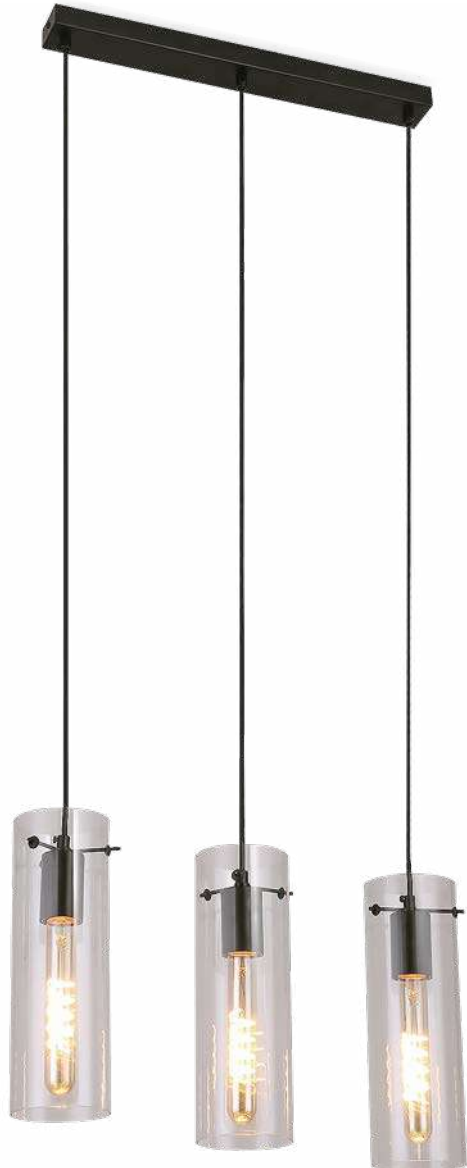

5259

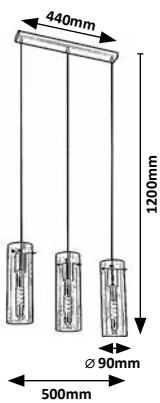

1200mm

∅ 90mm

500mm



5260

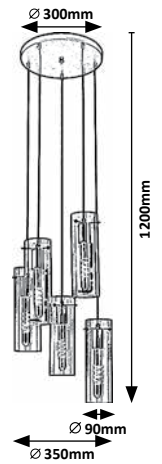

1200mm

∅ 90mm  
∅ 350mm

5258 (M) (G)

☒ E27 / 1x max. 40W  
IP20  
☑ 19611  
black/transparent



5 998250 352589

5259 (M) (G)

☒ E27 / 3x max. 40W  
IP20  
☑ 19611  
black/transparent



5 998250 352596

5260 (M) (G)

☒ E27 / 5x max. 60W  
IP20  
☑ 19611  
black/transparent



5 998250 352602





# PRUDENCE



2671

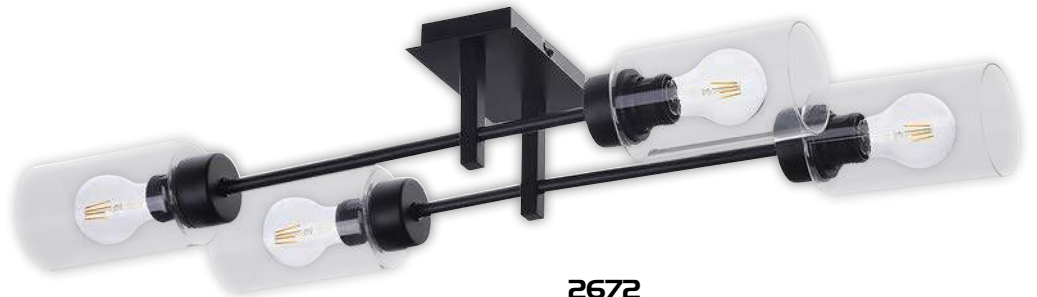
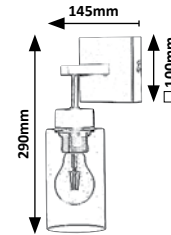

2672

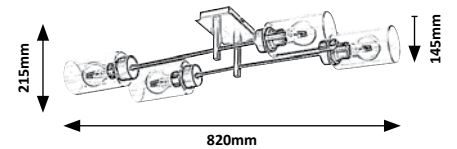

2671



2671 (M) (G)

☒ E27 / 1x max. 40W

IP20

19778

black/transparent



2672 (M) (G)

☒ E27 / 4x max. 40W

IP20

19778

black/transparent



# URSULA



3189

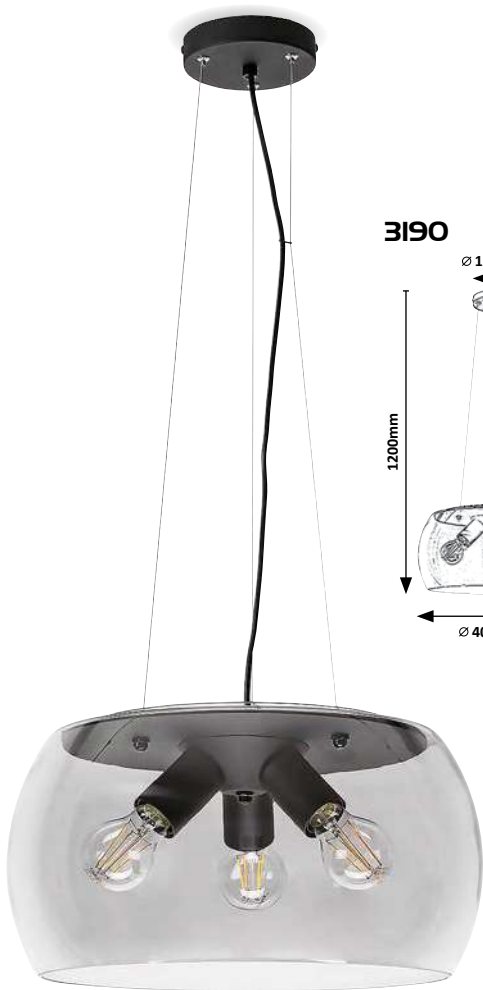
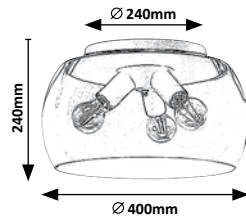

3190

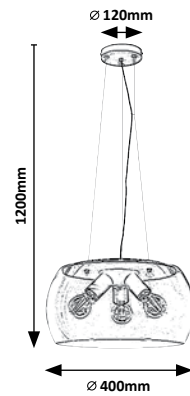

**3189** **M G**

☒ E27 / 3x max. 40W  
IP20  
☑ 19644

black/tinted colour



5 998250 331898

**3190** **M G**

☒ E27 / 3x max. 40W  
IP20  
☑ 19644

black/tinted colour



5 998250 331904

# AISHA



5358

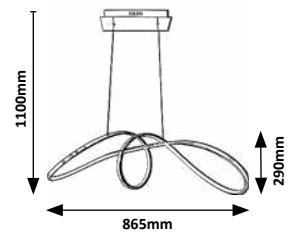

# PIERO



6955

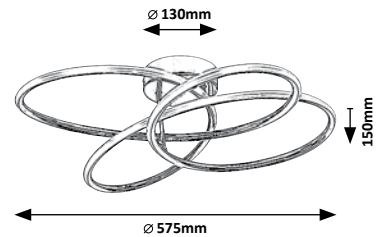

**5358** (M) (P)

LED / 38W  
(E) 2600lm; (E) 4250lm, 4000K) incl.  
IP20  
chrome/white



5 998250 353586

**6955** (M) (P)

LED / 30W  
(E) 2000lm; (E) 3400lm, 4000K) incl.  
IP20  
chrome/white



5 998250 369556



# RIVER



6899

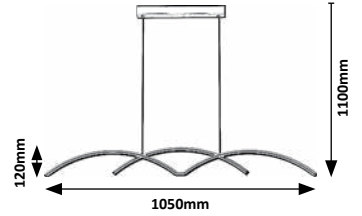

**6899**

**(M P)**

LED / 40W

(2000lm; 3500lm, 4000K) incl.

IP20

black/white



5 998250 368993

# YORDANA



5280

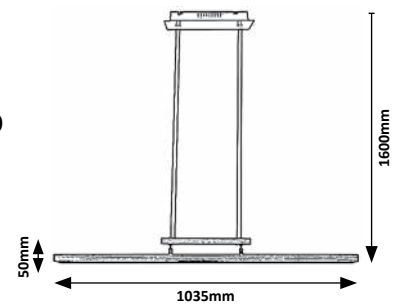

5280 (M) (P)

LED / 27W  
(1800lm; 3300lm, 3000K) incl.  
IP20

satın chrome/white



5 998250 352800

# EUCALYPTUS

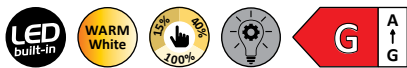

2957

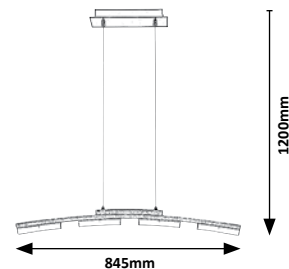

**2957** (M) (P)

LED / 20W  
(16) 1650lm; (14) 1760lm, 3000K incl.

IP20  
satin chrome/white



5 998250 329574



# 02

**INDUSTRIAL  
AND NORDIC**

**INDUSZTRIÁLIS ÉS  
SKANDINÁV**

**INDUSTRIAL UND  
SKANDINAVISCH**



# DARYL



**5270**



**5271**

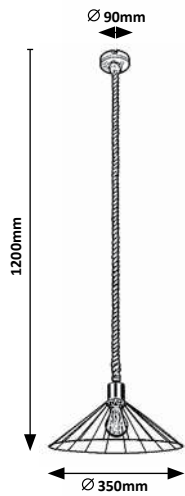

**5272**

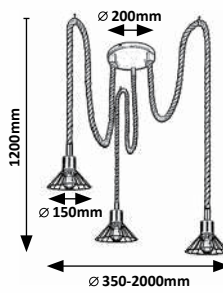

**5270** (M)

☒ E27 / 1x max. 40W  
IP20  
black



**5271** (M)

☒ E27 / 1x max. 40W  
IP20  
black



**5272** (M)

☒ E27 / 3x max. 40W  
IP20  
black



# FARFALLE

WOOD



**3148**

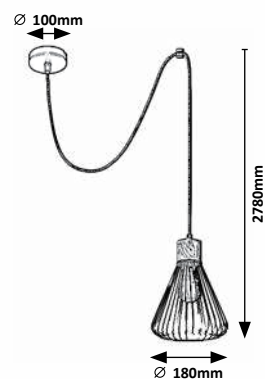

**3149**

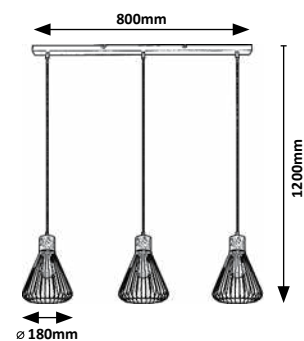

**3147** (M) (W)

☒ E14 / 1x max. 25W  
IP20  
black/beech



**3148** (M) (W)

☒ E27 / 1x max. 40W  
IP20  
black/beech



**3149** (M) (W)

☒ E27 / 3x max. 40W  
IP20  
black/beech



# FARFALLE



3150

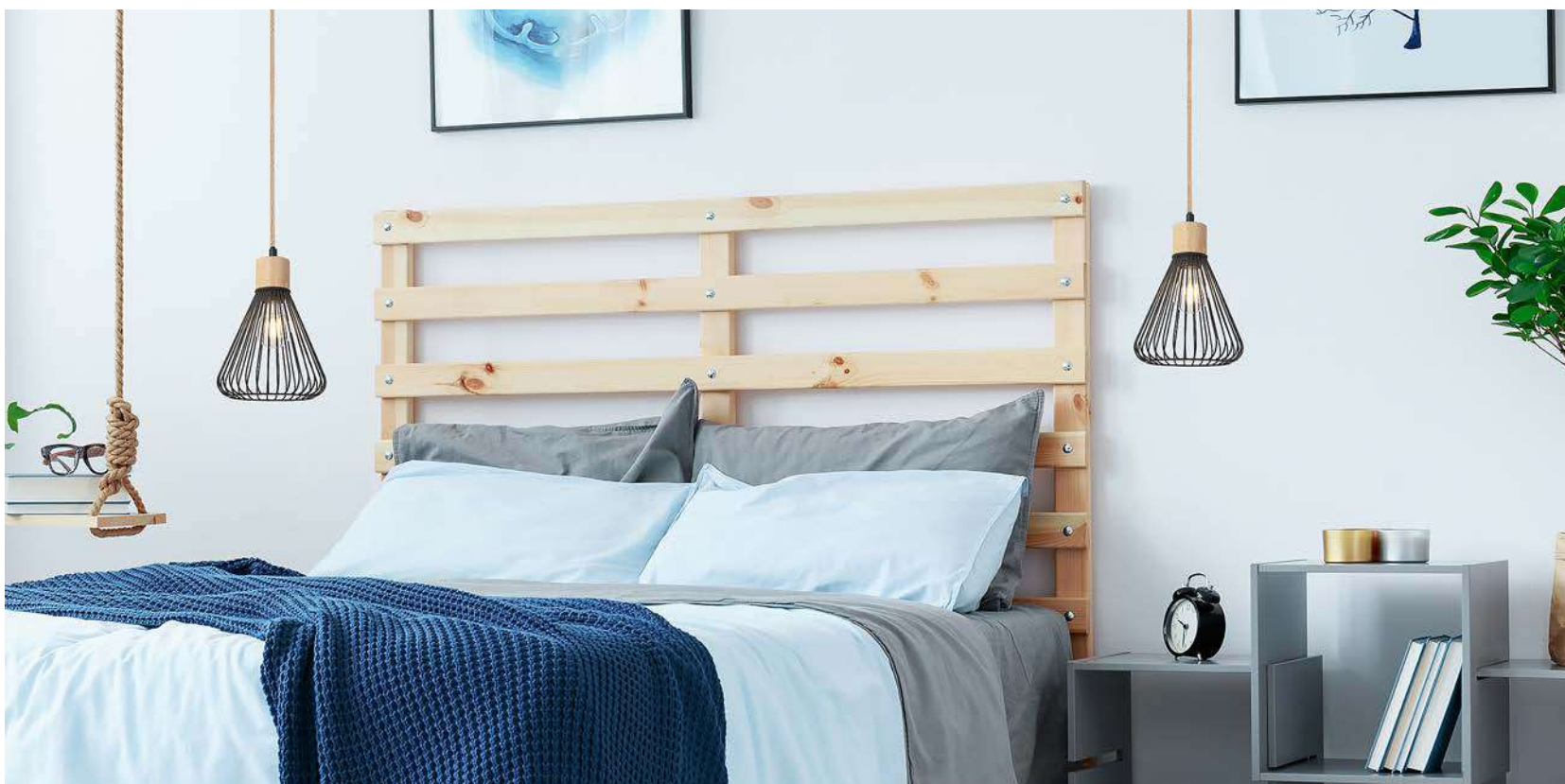
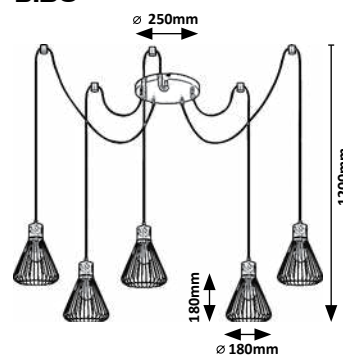

3150 **M** **W**

☒ E27 / 5x max. 40W  
IP20  
black/beech







# INDIGO

WOOD



2289

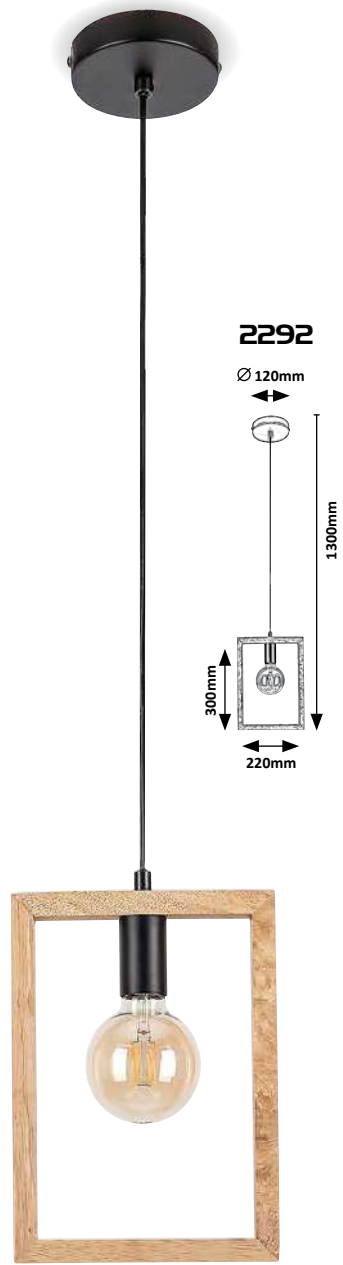
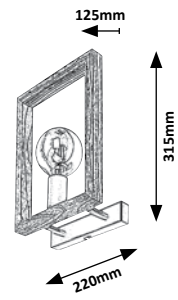

2292

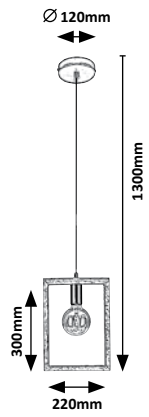

2289 **M W**

☒ E27 / 1x max. 40W  
IP20  
black/beech



2292 **M W**

☒ E27 / 1x max. 40W  
IP20  
black/beech





# INDIGO

WOOD

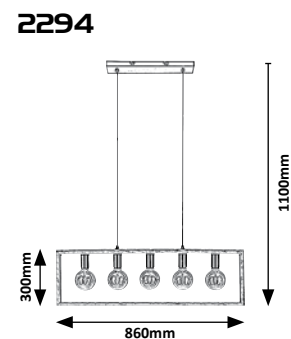
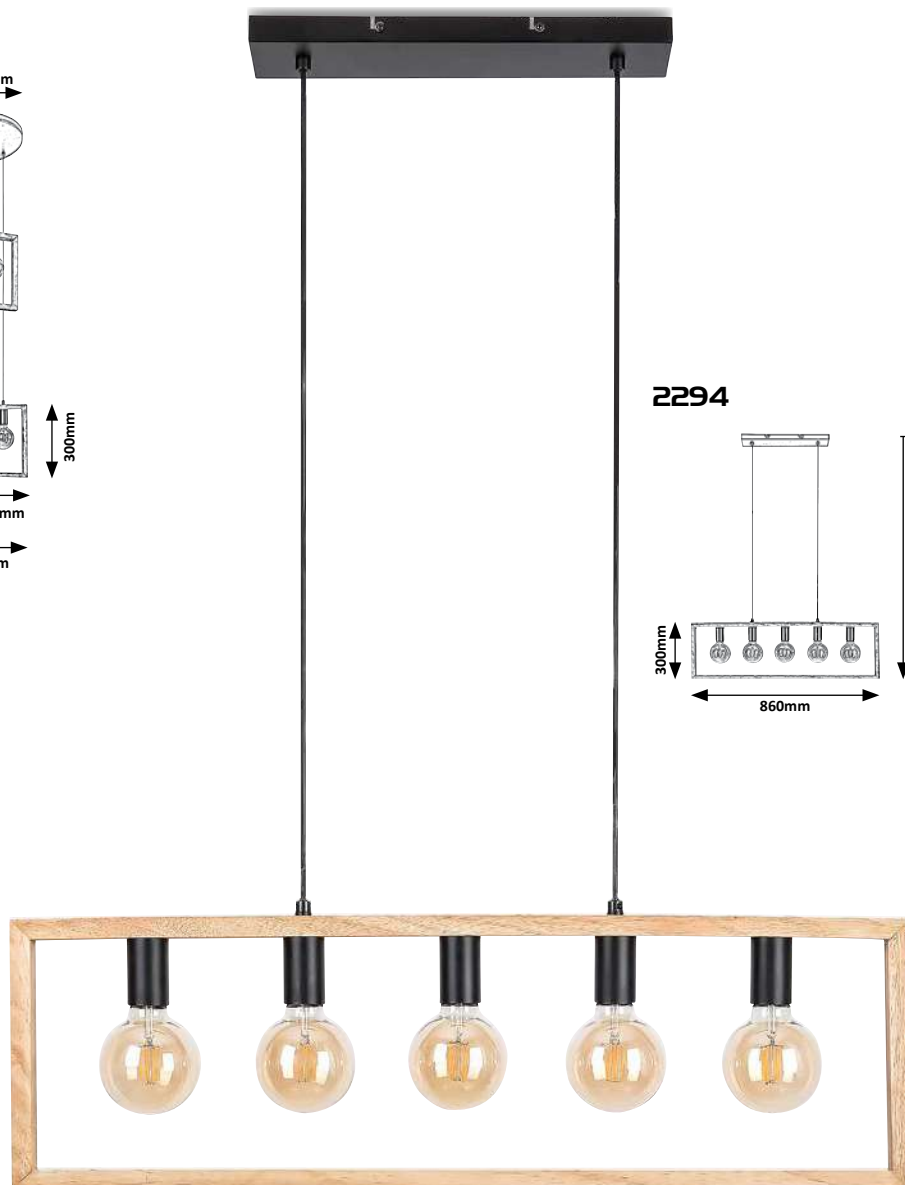
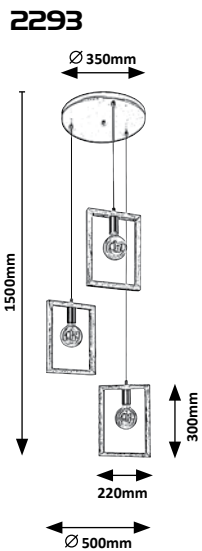

**2293** (M) (W)

☒ E27 / 3x max. 40W  
IP20  
black/beech



**2294** (M) (W)

☒ E27 / 5x max. 40W  
IP20  
black/beech





# 03

## SMART LIGHTS AND LED CEILING LAMPS

OKOS ÉS  
LED MENNYEZETI LÁMPÁK

SMART UND  
LED DECKENLEUCHTEN

# SMART LIGHTS



Our smart lights can be easily controlled from our smartphone or tablet using the TUYA application. We can control their brightness, color temperature or the color of the emitted light. Several of them have memory, night and timer functions.



Okoslámpáinkat a TUYA applikáció segítségével könnyedén irányíthatjuk okostelefonunkról vagy táblagépünkről. Szabályozhatjuk fényerejüket, színhőmérsékletüket vagy a kibocsátott fény színét. Közülük, több is rendelkezik memóriával, éjszakai és időzítőfunkcióval.



Unsere intelligenten Lichter können mit der TUYA-Anwendung einfach von unserem Smartphone oder Tablet aus gesteuert werden. Wir können ihre Helligkeit, Farbtemperatur oder die Farbe des emittierten Lichts steuern. Einige von ihnen verfügen über Speicher-, Nacht- und Timerfunktionen.



2249, 3146

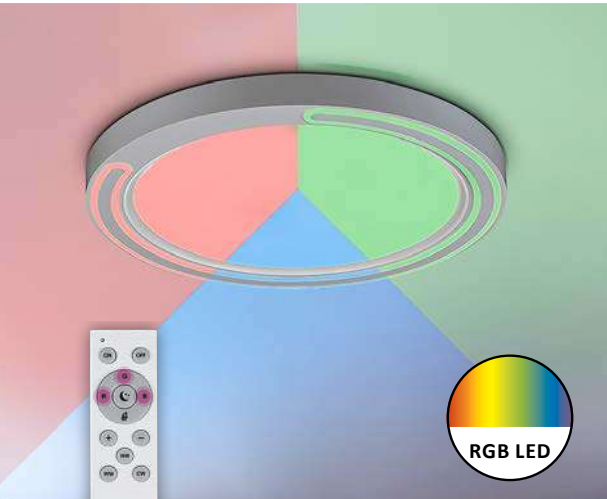

## TRITON

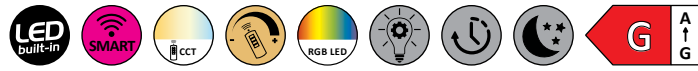

2249

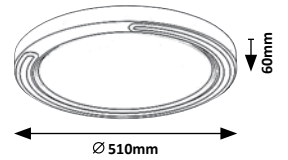

## ACHILLES



3146

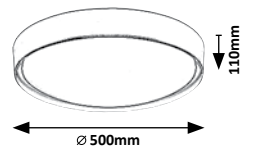

**2249** (M) (P)

LED / 40W  
 (E) 3200lm; (E) 4500lm, 2700K-6500K) incl.  
 IP20 • (E) 19925 • (E) 563  
 white



5 998250 322490

**3146** (M) (P)

LED / 40W  
 (E) 3200lm; (E) 4500lm, 2700K-6500K) incl.  
 IP20 • (E) 19675 • (E) 563  
 black/white



5 998250 331461



# RASMUS



2290

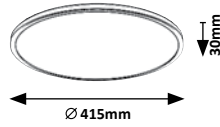

2291

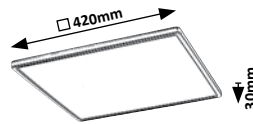

**2290**

**P**

LED / 22W  
 (☰) 2000lm; (☷) 2720lm, 4000K) incl.  
 IP20 • ⚡ 544  
 silver/white



5 998250 322902

**2291**

**P**

LED / 22W  
 (☰) 2100lm; (☷) 2850lm, 4000K) incl.  
 IP20 • ⚡ 544  
 silver/white



5 998250 322919

2290, 2291

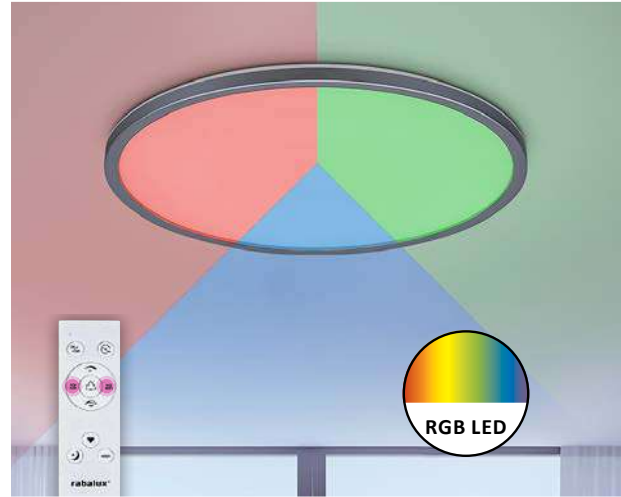

2249, 2290, 2291, 3146





## AZTEC



6905

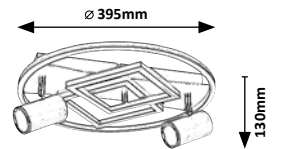

## MALCOLM



5366

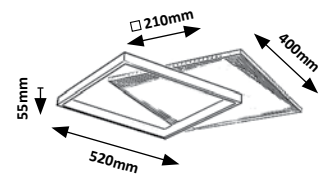

**5366** (M) (P)

LED / 35W  
 (☀) 2150lm; (🌙) 2500lm, 4000K) incl.  
 IP20  
 black/white



5 998250 353661

**6905** (M) (P)

LED / 40W  
 (☀) 2000lm; (🌙) 3350lm, 4000K) incl.  
 IP20  
 matte black/white



5 998250 369051

# STREGOBOR

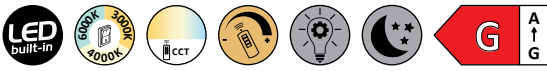

2937

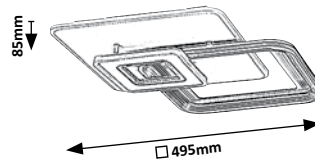

# HERKULES



2932

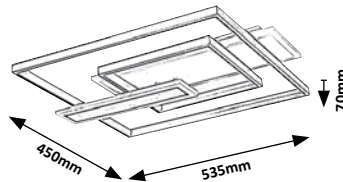

2937

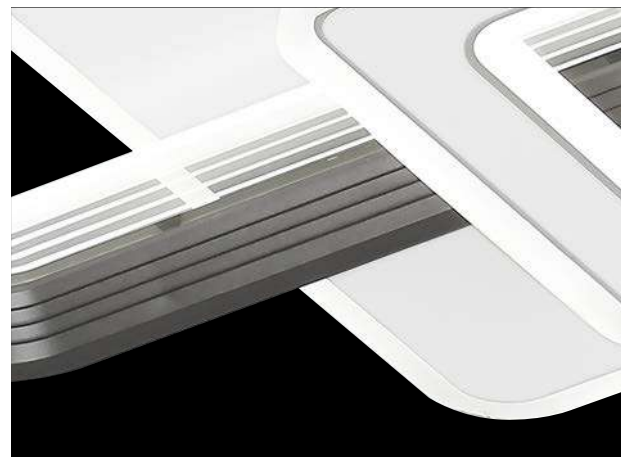

2932 (M) (P)

LED / 50W  
 (☼) 2700lm; (☼) 6430lm, 4000K) incl.  
 IP20  
 black/white



5 998250 329321

2937 (M) (A)

LED / 48W  
 (☼) 2950lm; (☼) 5170lm, 3000K, 4000K, 6000K) incl.  
 IP20 • 523  
 grey/white/chrome



5 998250 329376



# CASIMIR



5267

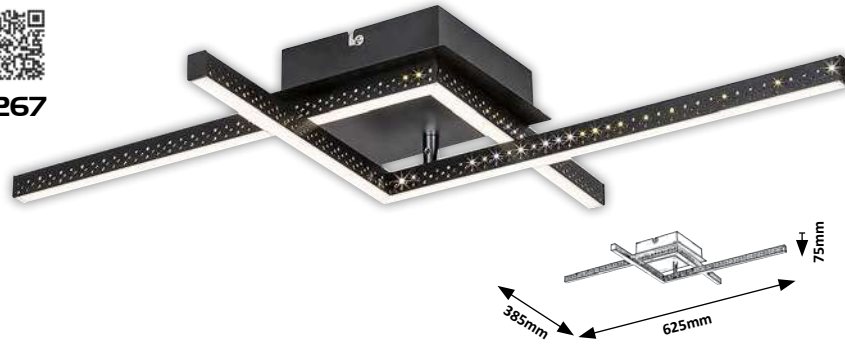

5268



5269

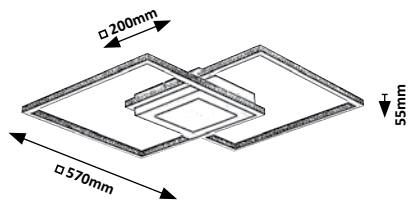

5267 (M) (P)

LED / 23W  
 (E) 1250lm; (E) 1800lm, 4000K) incl.  
 IP20  
 matte black/white



5 998250 352671

5268 (M) (P)

LED / 35W  
 (E) 1970lm; (E) 3050lm, 4000K) incl.  
 IP20  
 matte black/white



5 998250 352688

5269 (M) (P)

LED / 40W  
 (E) 2000lm; (E) 3050lm, 4000K) incl.  
 IP20  
 matte black/white



5 998250 352695



# NAYARA

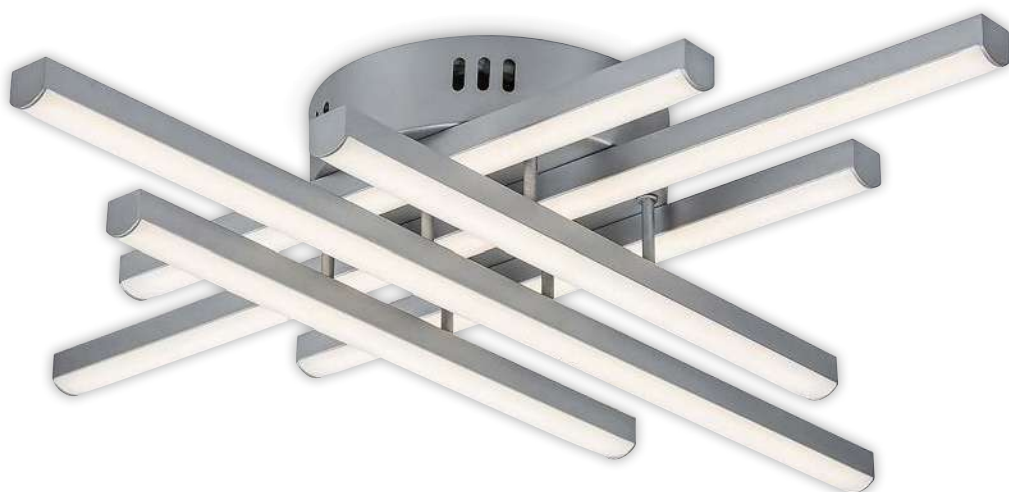

3014

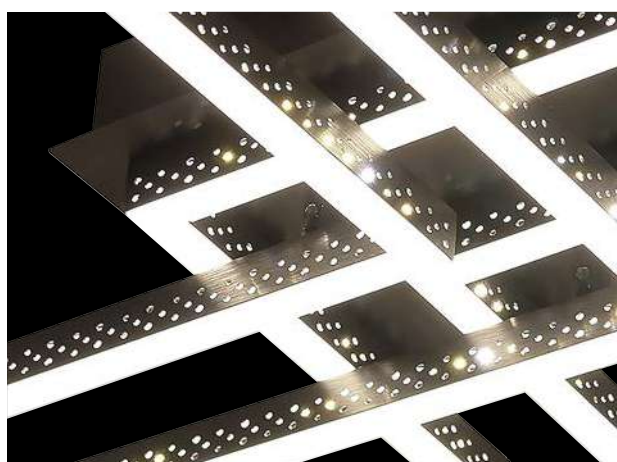
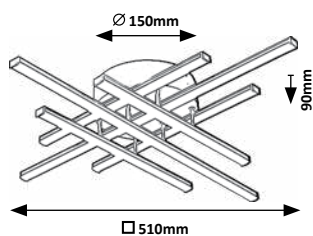

3014

M P

LED / 40W  
(2050lm; 4000lm, 4000K) incl.  
IP20  
silver/white



5 998250 330143

5256



# QUINCE



3084

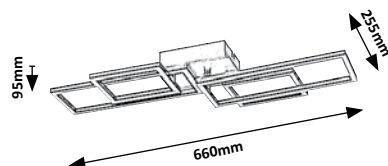

# OCEAN

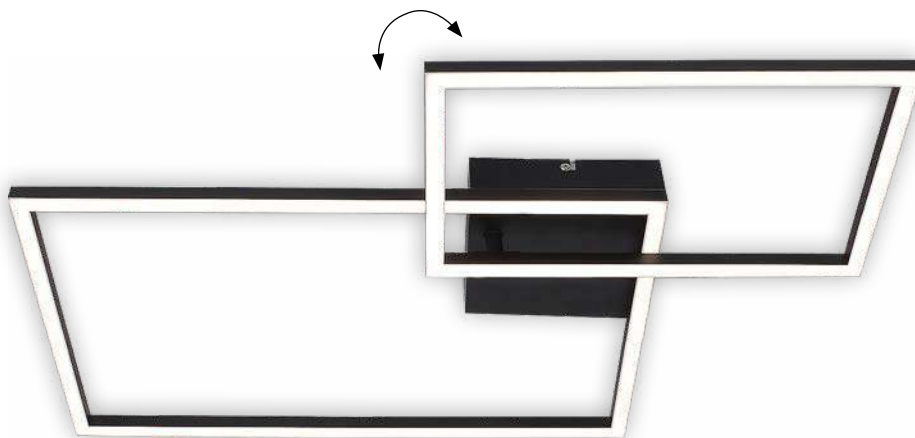

5256

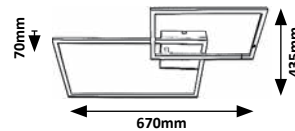

**3084** (M) (P)

LED / 40W  
 (E) 2400lm; (E) 4350lm, 4000K) incl.  
 IP20  
 black/white



5 998250 330846

**5256** (M) (P)

LED / 26W  
 (E) 1700lm; (E) 3350lm, 4000K) incl.  
 IP20  
 matte black/white



5 998250 352565

# HEIMDALL



2280

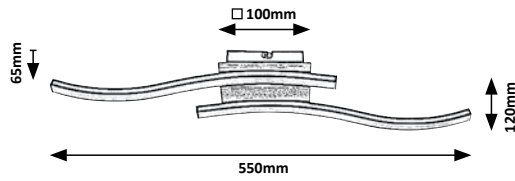

2281

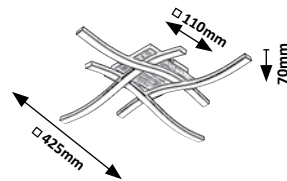

**2280**

**(M P)**

LED / 12W  
 (E) 700lm; (E) 1050lm, 3000K incl.  
 IP20  
 matte black/white



5 998250 322803

**2281**

**(M P)**

LED / 20W  
 (E) 1300lm; (E) 1800lm, 3000K incl.  
 IP20  
 matte black/white



5 998250 322810





# TATJANA



3143

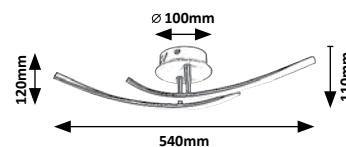

3144

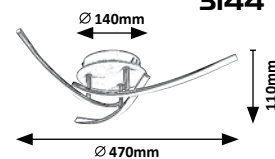

3145

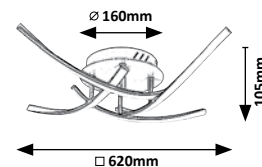

**3143** (M) (P)

LED / 15W  
 (E) 1000lm; (E) 1550lm, 4000K) incl.  
 IP20  
 silver/white



5 998250 331430

**3144** (M) (P)

LED / 22W  
 (E) 1400lm; (E) 2300lm, 4000K) incl.  
 IP20  
 silver/white



5 998250 331447

**3145** (M) (P)

LED / 30W  
 (E) 1950lm; (E) 3000lm, 4000K) incl.  
 IP20  
 silver/white



5 998250 331454



# SIGURD

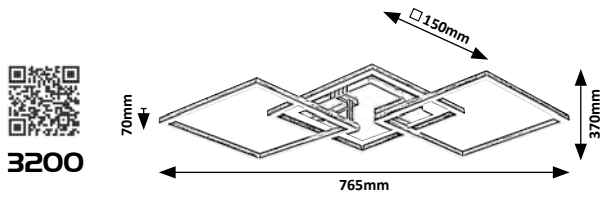

# FULVIA

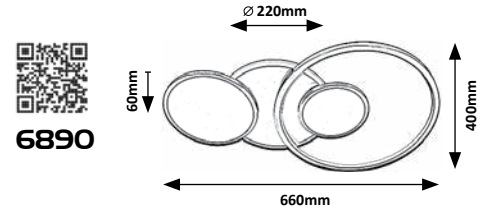

# CESARIO

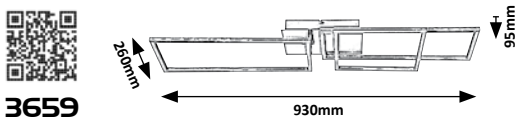

**3200** (M) (P)

LED / 43W  
 (E) 2900lm; (E) 3900lm, 3000K) incl.  
 IP20  
 chrome/white



**3659** (M) (P)

LED / 44W  
 (E) 3100lm; (E) 4300lm, 4000K) incl.  
 IP20  
 chrome/white



**6890** (M) (A)

LED / 50W  
 (E) 3200lm; (E) 5700lm, 3000K) incl.  
 IP20  
 satin chrome/white





# 04

**SPOTS, RECESSED  
AND SURFACE  
MOUNTED LIGHTING**

**SPOTOK, BE- ÉS  
RÁÉPÍTHETŐ LÁMPÁK**

**SPOTS, EIN- UND  
AUFBAULEUCHTENT**

# SPOT RELIGHT



**2150**

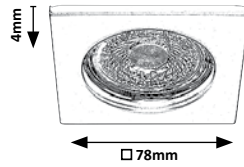

**2151**

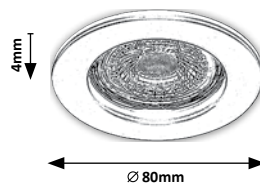

**2150**



☒ GU5.3 / 1x max. 25W  
IP20 • □ 58mm • ↓ 26mm  
black



5 998250 321509

**2151**



☒ GU5.3 / 1x max. 25W  
IP20 • □ 58mm • ↓ 26mm  
black



5 998250 321516



# SOLO



2081



2082



2083

**2081** (M)  
☒ GU10 / 1x max. 25W  
IP20 • □  
white



**2082** (M)  
☒ GU10 / 2x max. 25W  
IP20  
white



**2083** (M)  
☒ GU10 / 4x max. 25W  
IP20  
white





# SOLO



**2084**



☒ GU10 / 1x max. 25W  
IP20 • □  
black



5<sup>9</sup> 998250 320847

**2085**



☒ GU10 / 2x max. 25W  
IP20  
black



5<sup>9</sup> 998250 320854

**2086**



☒ GU10 / 4x max. 25W  
IP20  
black



5<sup>9</sup> 998250 320861



# SHAUN



2678

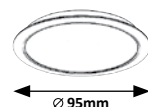

Ø 95mm



2679



Ø 145mm



2680



Ø 170mm



2681



Ø 220mm

**2678**

**P**

LED / 5W  
(450lm, 4000K) incl.  
IP20 • ↓ 26mm  
black/white



5<sup>9</sup> 998250 326788

**2679**

**P**

LED / 12W  
(1035lm, 4000K) incl.  
IP20 • ↓ 26mm  
black/white



5<sup>9</sup> 998250 326795

**2680**

**P**

LED / 17W  
(1500lm, 4000K) incl.  
IP20 • ↓ 26mm  
black/white



5<sup>9</sup> 998250 326801

**2681**

**P**

LED / 24W  
(2300lm, 4000K) incl.  
IP20 • ↓ 26mm  
black/white



5<sup>9</sup> 998250 326818

# SHAUN



2682



2683

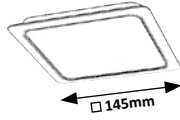

2684

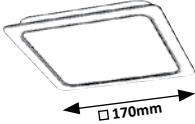

2685

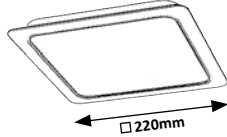

**2682**



LED / 5W  
(450lm, 4000K) incl.  
IP20 • 26mm  
black/white



5 998250 326788

**2683**



LED / 12W  
(1035lm, 4000K) incl.  
IP20 • 26mm  
black/white



5 998250 326795

**2684**



LED / 17W  
(1500lm, 4000K) incl.  
IP20 • 26mm  
black/white



5 998250 326801

**2685**



LED / 24W  
(2300lm, 4000K) incl.  
IP20 • 26mm  
black/white



5 998250 326818



# SHAUN



2686

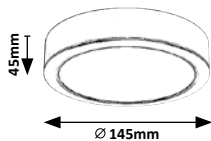

2687

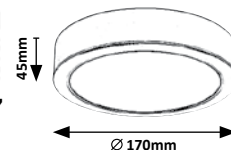

2688

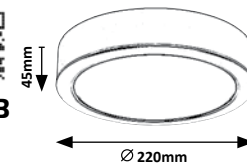

2689

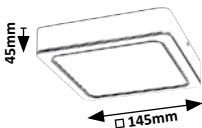

2690

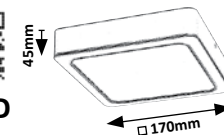

2691

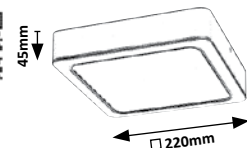

**2686**

**(P)**

LED / 12W  
(1035lm, 4000K) incl.  
IP20  
black/white



5 998250 326863

**2687**

**(P)**

LED / 17W  
(1500lm, 4000K) incl.  
IP20  
black/white



5 998250 326870

**2688**

**(P)**

LED / 24W  
(2300lm, 4000K) incl.  
IP20  
black/white



5 998250 326887

**2689**

**(P)**

LED / 12W  
(1035lm, 4000K) incl.  
IP20  
black/white



5 998250 326894

**2690**

**(P)**

LED / 17W  
(1500lm, 4000K) incl.  
IP20  
black/white



5 998250 326900

**2691**

**(P)**

LED / 24W  
(2300lm, 4000K) incl.  
IP20  
black/white



5 998250 326917



# SHAUN



2692

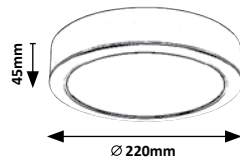

2693

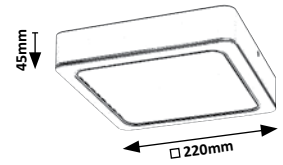

# COCO



5274

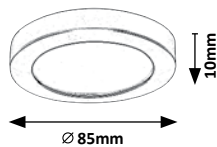

5275

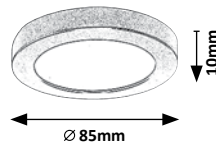

5276

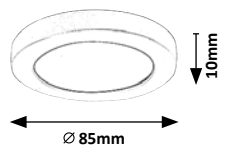

2692

(P)

LED / 24W  
(2400lm, 4000K) incl.  
IP44  
black/white



5 998250 326924

2693

(P)

LED / 24W  
(2400lm, 4000K) incl.  
IP44  
black/white



5 998250 326931

5274

(P)

LED / 3W  
(220lm; 400lm, 4000K) incl.  
IP44 • 25mm  
black/white



5 998250 352749

5275

(P)

LED / 3W  
(230lm; 400lm, 4000K) incl.  
IP44 • 25mm  
silver/white



5 998250 352756

5276

(P)

LED / 3W  
(250lm; 400lm, 4000K) incl.  
IP44 • 25mm  
white



5 998250 352763



# 05

## FLOOR, TABLE LAMPS AND DECORATIVE LAMPS

ÁLLÓ-, ASZTALI-, FALI-  
ÉS DEKORLÁMPÁK

STEH-, TISCH-, WAND-  
UND DEKORLAMPEN

# NILFGARD

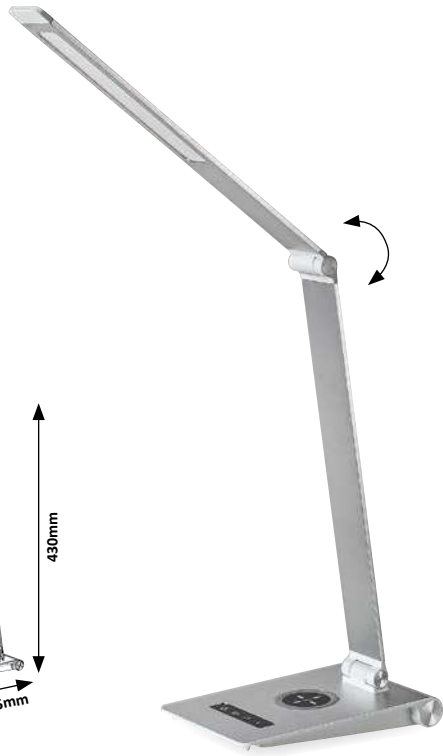

2029

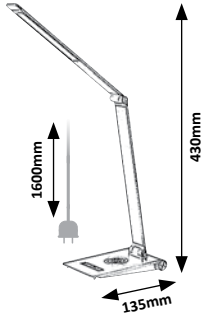

2029



2934



# HORUS

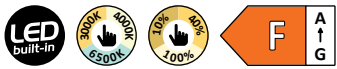

2934

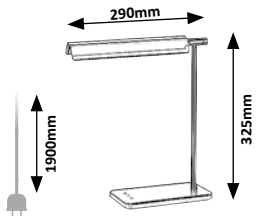

2029 (M) (P)

LED / 13W  
 (E) 890lm; (E) 1200lm, 2800K-5000K incl.  
 IP20  
 silver/white



5 998250 320298

2934 (M) (P)

LED / 7W  
 (E) 530lm; (E) 750lm, 3000K, 4000K, 6500K incl.  
 IP20  
 black



5 998250 329345



2in1



# DRACO



2310

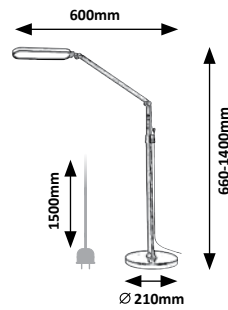

2310 (M) (P)

LED / 13W  
790lm; 1050lm, 3000K-6000K incl.  
IP20  
black/white





# ARISTEO

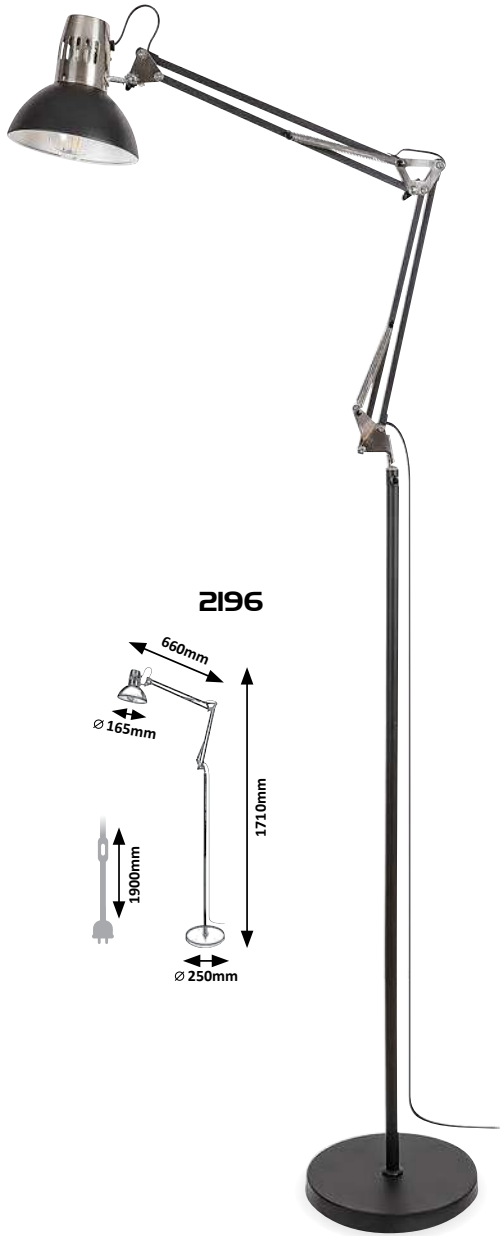

2196

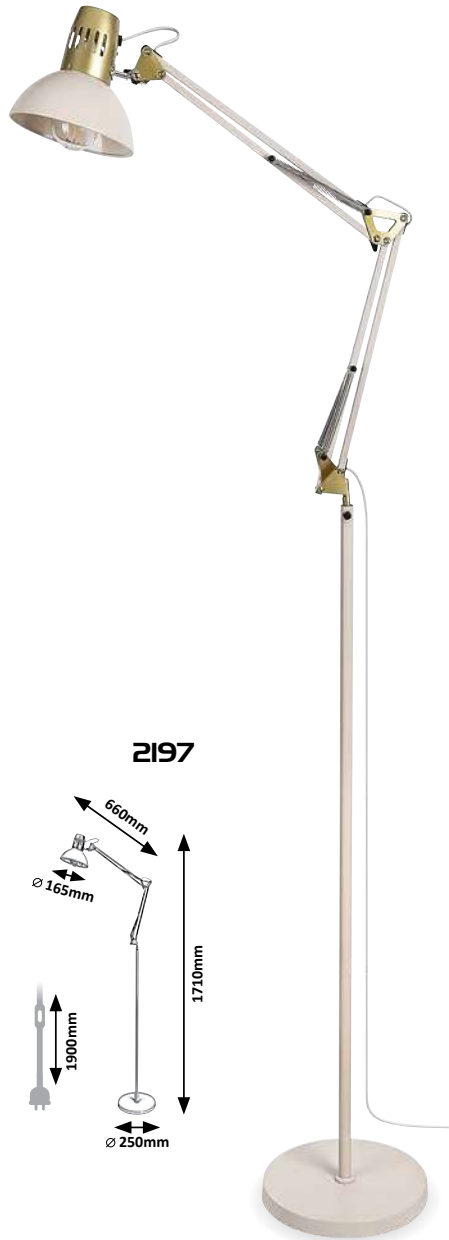
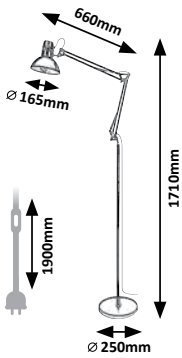

2197

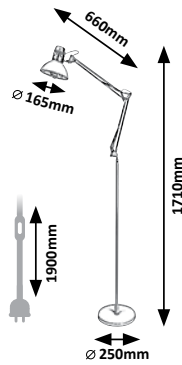

2196

(M)

☒ E27 / 1x max. 40W  
IP20 •   
matte black/silver



5 998250 321967

2197

(M)

☒ E27 / 1x max. 40W  
IP20 •   
beige/gold



5 998250 321974

# FLINT

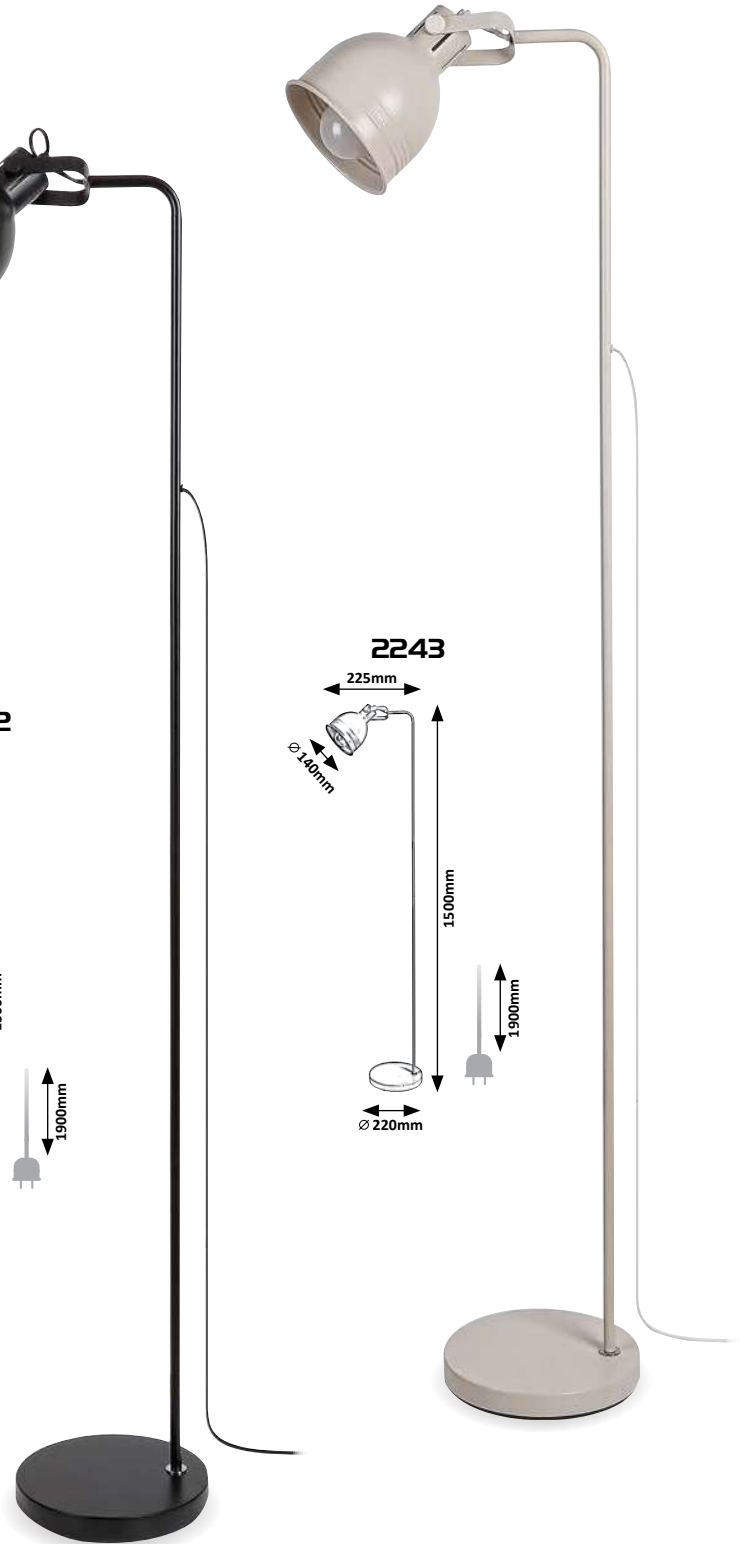
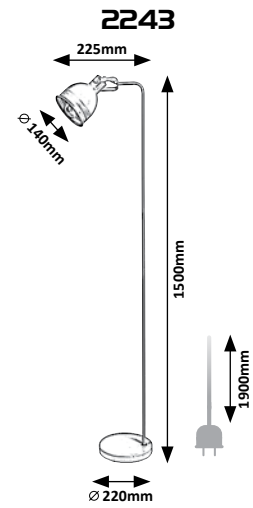
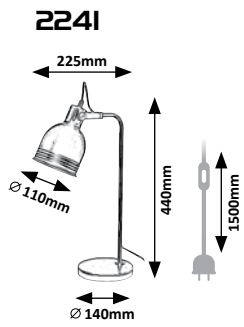
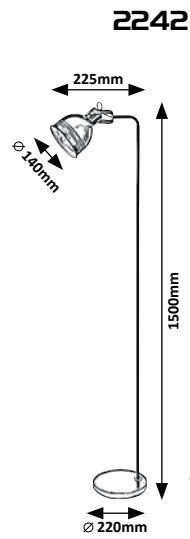
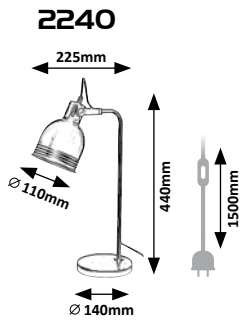

**2240** (M)  
 ☒ E14 / 1x max. 25W  
 IP20 •   
 black/white



5 998250 322407

**2241** (M)  
 ☒ E14 / 1x max. 25W  
 IP20 •   
 beige/white



5 998250 322414

**2242** (M)  
 ☒ E27 / 1x max. 40W  
 IP20 •   
 black/white



5 998250 322421

**2243** (M)  
 ☒ E27 / 1x max. 40W  
 IP20 •   
 beige/white



5 998250 322438

# BRUNO

WOOD



2090

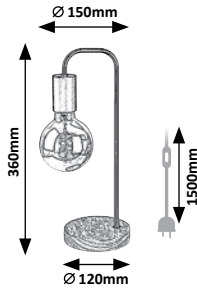

# LYCHEE

WOOD



2069

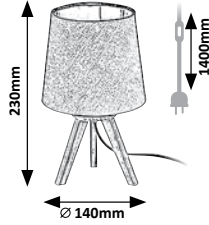

2068

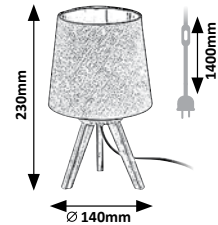

2090 (M) (W)

☒ E27 / 1x max. 40W  
IP20 • black/beech



5 998250 320908

2068 (W) (T)

☒ E14 / 1x max. 25W  
IP20 •   
19822  
beech/beige



5 998250 320887

2069 (W) (T)

☒ E14 / 1x max. 25W  
IP20 •   
19823  
beech/black



5 998250 320894

 2295, 2296



OFF

ON

## LYDIA



2295

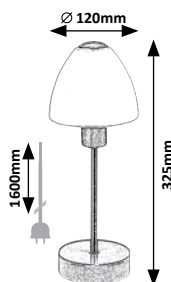

2296

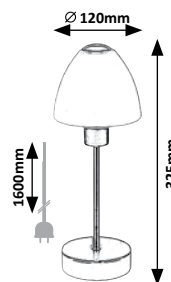

## PUMPKIN



2282



2283



2295 **M G**

☒ E14 / 1x max. 40W  
IP20  
☑ 19777  
silver/white



5 998250 322957

2296 **M G**

☒ E14 / 1x max. 40W  
IP20  
☑ 19777  
matte black/white



5 998250 322964

2282 **P**

☒ LED / 0,5W  
(5lm, 3000K) incl.  
IP20  
white



5 998250 322827

2283 **P**

☒ LED / 0,5W  
(5lm, 3000K) incl.  
IP20  
white



5 998250 322834



# ARIEL



2145

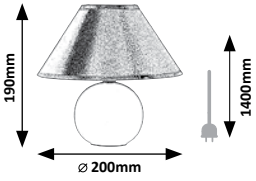

2146

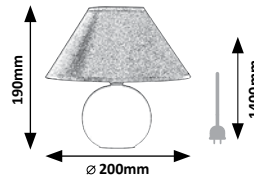

2282, 2283



2145 **CT**

☒ E14 / 1x max. 40W  
IP20  
19824  
rose



2146 **CT**

☒ E14 / 1x max. 40W  
IP20  
19853  
grey



# KEY OF SYMBOLS • JELMAGYARÁZAT • ZEICHENERKLÄRUNG



GBR



HUN



GER



FRA



CZE



SVK



POL



UKR

	Symbols	Jelölések	Bezeichnungen	Symboles	Jména	Označenia	Oznaczenia	Позначення
	built-in LED	beépített LED	LED inklusive	LED inclus	obsahuje LED	obsahuje LED diódy	Dioda LED w wyposażeniu	містить світлодіоди
	Smart product	Okos termék	intelligentes Produkt	produit intelligent	chytrý produkt	inteligentný produkt	inteligentny produkt	розумний продукт
	warm white light	meleg fehér fényű	warmweiß	blanc chaud	teplá bílá	teplá biela	ciepła biała	теплий білий
	natural white light	természetes fehér fényű	naturweiß	blanc naturel	přírozená bílá	přírodní biela	naturalna biała	натуральний білий
	colour temperature variable with remote control	távírányítóval állítható színhőmérséklet	Mit fernbedienung einstellbare Farbtemperatur	Température de couleur réglable par télécommande	Nastavení teploty chromatičnosti dálkovým ovládačem	Možnosť nastavenia teploty farieb s diaľkovým ovládačom	Zmienna temperatura barwowa za pomocą pilota	Регулювання колірної температури через пульт дистанційного керування
	Color temperature can be adjusted in 3 steps with a switch	Kapcsolóval 3 lépésben szabályozható színhőmérséklet	Die Farbtemperatur kann mit einem Schalter in 3 Stufen eingestellt werden	La température de couleur peut être ajustée en 3 étapes avec un interrupteur	Teplotu barev lze nastavit pomocí přepínače ve 3 krocích	Farebnú teplotu je možné nastaviť v 3 krokoch pomocou prepínača	Temperaturę barwową można regulować w 3 krokach za pomocą przełącznika	Колірну температуру можна регулювати в 3 кроки за допомогою перемикача
	Color temperature can be adjusted in three steps with a touch switch	Érintőkapcsolóval három lépésben szabályozható színhőmérséklet	Die Farbtemperatur kann in drei Stufen mit einem Touch-Schalter eingestellt werden	La température de couleur peut être ajustée en trois étapes avec un interrupteur tactile	Teplotu barev lze upravit ve třech krocích dotykovým spínačem	Teplotu farby je možné nastaviť v troch krokoch pomocou dotykového spínača	Temperaturę barwową można regulować w trzech krokach za pomocą przełącznika dotykowego	Колірну температуру можна регулювати в три етапи за допомогою сенсорного сенсорного перемикача
	Color temperature can be adjusted in five steps with a touch switch	Érintőkapcsolóval öt lépésben szabályozható színhőmérséklet	Die Farbtemperatur lässt sich per Touch-Schalter in fünf Stufen einstellen	La température de couleur peut être ajustée en cinq étapes avec un interrupteur tactile	Teplotu barev lze upravit v pěti krocích dotykovým spínačem	Teplotu farby je možné nastaviť v piatich krokoch dotykovým spínačem	Temperaturę barwową można regulować w pięciu krokach za pomocą przełącznika dotykowego	Колірну температуру можна регулювати в п'ять кроків за допомогою сенсорного перемикача
	RGB colour change LED	RGB színváltós LED	Farbwechsel-LED	LED à changement de couleurs	LED diody střídající barvu	LED s meniacou sa farbou	Zmieniający kolor LED	Світлодіоди зі зміною кольору
	with switch	kapcsolóval	mit Schalter	avec commutateur	se spínačem	so spínačom	z włącznikiem	із перемикачем
	light intensity variable with remote control	csak távírányítóval állítható fényerő	Lichtintensität nur mit Fernbedienung einstellbar	intensité lumineuse variable uniquement avec télécommande	intenzitu světla lze nastavit pouze pomocí dálkového ovládání	možnosť nastavenia intenzity svetla iba s diaľkovým ovládačom	natężenie światła regulowane tylko przy pomocy pilota	інтенсивність світла регулюється тільки за допомогою пульта
	touch switch dimmer	érintőkapcsolóval szabályozható fényerő	Touchbutton-Lichtstärkeregler	réglage de la luminosité avec interrupteur tactile	nastavení jasu dotykovým spínačem	dotykový spínač na regulácia intenzity svetla	ściemniacz dotykowy	сенсорний диммер
	Brightness can be adjusted in three steps with a touch switch	Érintőkapcsolóval három lépésben szabályozható fényerő	Die Helligkeit lässt sich per Touch-Schalter in drei Stufen regulieren	La luminosité peut être ajustée en trois étapes avec un interrupteur tactile	Jas lze upravit ve třech krocích dotykovým spínačem	Jas je možné nastaviť v troch krokoch dotykovým spínačom	Jasność można regulować w trzech krokach za pomocą przełącznika dotykowego	Яскравість можна регулювати в три кроки за допомогою сенсорного перемикача
	Brightness can be adjusted in five steps with a touch switch	Érintőkapcsolóval öt lépésben szabályozható fényerő	Die Helligkeit lässt sich per Touch-Schalter in fünf Stufen regulieren	La luminosité peut être ajustée en cinq étapes avec un interrupteur tactile	Jas lze nastavit v pěti krocích dotykovým spínačem	Jas je možné nastaviť v piatich krokoch dotykovým spínačom	Jasność można regulować w pięciu krokach za pomocą przełącznika dotykowego	Яскравість можна регулювати в п'ять кроків за допомогою сенсорного перемикача
	The use of a dimmable light source is required for the dimmer function	Fényerőszabályozható fényforrás használata szükséges a fényerőszabályozó funkcióhoz	Für die Dimmfunktion ist die Verwendung eines dimmbaren Leuchtmittels erforderlich	L'utilisation d'une source lumineuse variable est nécessaire pour la fonction variateur	Pro funkci stmívače je nutné použití stmívatelného zdroje světla	Pre funkciu stmievача je potrebné použitie stmievateľného svetelného zdroja	Do funkcji ściemniacza wymagane jest użycie ściemnianego źródła światła	Для функції диммера потрібне джерело світла з можливістю затемнення

# KEY OF SYMBOLS • JELMAGYARÁZAT • ZEICHENERKLÄRUNG



	Simboluri	Označavanje	Oznake	Oznake	Символи	Simboliai	Simboli	Sümbolid
	LED încorporat	ugrađeni LED	ugrađeni LED	vgrajen LED	вграден LED	įmontuotas LED įrenginys	ieibūvēta LED	sisse-ehitatud LED
	produs inteligent	паметан производ	pametnan proizvod	pameten izdelek	интелигентен продукт	protingas produktas	gudrs produkts	tark toode
	alb cald	toplo bela	toplo bijelo	toplo bela	топло бяло	šiltai balta	silti balts	soe valge
	alb natural	prirodno bela	prirodno bijelo	naravno bela	естественно бяло	natūraliai balta	dabīgi balts	loomulik valge
	Temperatura colorii reglabilă de la telecomandă	Sa daljinskim prekidačem može da se podesei temperatura boja	Pomoću daljinskog prekidača možete podeseiti temperaturu boje	Barvno temperaturo lahko nastavite z daljinskim stikalom	Регулиране на цветната температура с дистанционно управление	Kintanti spalvinė temperatūra su nuotoliniu pulteliu	Maināma krāsu temperatūra ar tālvadības pulti	Muutuv värvustemperatuur kaugjuhtimisega
	Temperatura de culoare poate fi reglată în 3 trepte cu un comutator	Температура боје се може подесити у 3 корака помоћу прекидача	Температура боје може се подесити у 3 корака помоћу прекидача	Barvno temperaturo lahko nastavite v 3 korakih s stikalom	Цветовата температура може да се регулира на 3 стъпки с превключвател	Spalvos temperatūrą galima reguliuoti 3 žingsniais jungikliu	Krāsu temperatūru var regulēt 3 soļos ar slēdzi	Värvitemperatuuri saab lülitiga reguleerida 3 astmes
	Temperatura colorii poate fi ajustată în trei pași cu un comutator tactil	Температура боје се може подесити у три корака помоћу прекидача на додир	Температура боје може се подесити у три корака помоћу прекидача на додир	Barvno temperaturo lahko nastavite v treh korakih s stikalom na dotik	Цветовата температура може да се регулира на три стъпки с сензорен превключвател	Spalvos temperatūrą galima reguliuoti trimis žingsniais jutikliniu jungikliu	Krāsu temperatūru var regulēt trīs soļos ar skārienslēdzi	Värvitemperatuuri saab puutetundliga kolmes astmes reguleerida
	Temperatura colorii poate fi ajustată în cinci trepte cu ajutorul unui comutator tactil	Температура боје може се подесити у пет корака помоћу прекидача на додир	Температура боје може се подесити у пет корака помоћу прекидача на додир	Barvno temperaturo lahko nastavite v petih korakih s stikalom na dotik	Цветовата температура може да се регулира в пет стъпки с сензорен превключвател	Spalvos temperatūrą galima reguliuoti penkiaais žingsniais jutikliniu jungikliu	Krāsu temperatūru var regulēt piecos posmos ar skārienslēdzi	Krāsu temperatūru var regulēt piecos posmos ar skārienslēdzi
	LED RGB	LED sa promjenjivim bojama	LED s promjenjivim bojama	LED diode s spremenljivim barvama	LED с променлива светлина	Spalvą keičiantis LED	Maināmas krāsas LED	Värvi vahetav LED
	cu întrerupător	sa prekidačem	s prekidačem	s stikalom	с превключвател	su jungikliu	ar slēdzi	lülitiga
	Intensitate variabilă a luminii numai de la telecomandă	Intenzitet svetlosti podesiv samo uz pomoć daljinskog upravljača	jačina svjetla promjenjiva samo sa daljinskim upravljačem	možnost nastavite jakosti svetlobe samo z daljinskim upravljanjem	димирание само чрез дистанционно управление	tik šviesos stiprio kintamasis su nuotoliniu valdymo pultu	gaismas intensitāte mainīga tikai ar tālvadības pulti	valguse intensiivsust saab reguleerida ainult kaugjuhtimispuldi abil
	senzor tactil pentru reglarea luminozității	podešavanje jačine svetlosti sa prekidačem na dodir	podešavanje svjetline pomoću dodirne sklopke	Prilagodite svetlost z stikalom na dotik	регулатор на яркостта със сензорен превключвател	liečiamasis pritemdymo jutiklis	skārienjutīgs gaismaīna slēdis	puutetundlik valgusregulaator
	Luminozitatea poate fi reglată în trei pași cu un comutator tactil	Осветљеност се може подесити у три корака помоћу прекидача на додир	Светлина се може подесити у три корака помоћу прекидача на додир	Svetlost je mogoče prilagoditi v treh korakih s stikalom na dotik	Яркостта може да се регулира в три стъпки със сензорен превключвател	Ryškumą galima reguliuoti trimis žingsniais jutikliniu jungikliu	Spilgtumu var regulēt trīs soļos ar skārienslēdzi	Heledust saab puutetundliga kolmes astmes reguleerida
	Luminozitatea poate fi ajustată în cinci trepte cu un comutator tactil	Осветљеност се може подесити у пет корака помоћу прекидача на додир	Светлина се може подесити у пет корака помоћу прекидача на додир	Svetlost lahko nastavite v petih korakih s stikalom na dotik	Яркостта може да се регулира в пет стъпки със сензорен превключвател	Ryškumą galima reguliuoti penkiaais žingsniais jutikliniu jungikliu	Spilgtumu var regulēt piecos soļos ar skārienslēdzi	Heledust saab puutetundliga viies astmes reguleerida
	Utilizarea unei surse de lumină reglabilă este necesară pentru funcția de dimmer	За функцију затамњивања потребна је употреба извора светлости са могућношћу пригушивања	За функцију затамњивања потребна је употреба извора свјетлости који се може пригушити	Za funkcijo zatemnitve je potrebna uporaba svetlobnega vira, ki ga je mogoče zatemniti	За функцията за димер е необходимо използването на димирем източник на светлина	Pritemdymo funkcijai reikia naudoti pritemdomą šviesos šaltinį	Reostata funkcijai ir nepieciešams izmantot aptumšojams gaismas avots	Härmardamise funktsiooni jaoks on vaja kasutada hämardavat valgusallikat

# KEY OF SYMBOLS • JELMAGYARÁZAT • ZEICHENERKLÄRUNG



GBR



HUN



GER



FRA



CZE



SVK



POL



UKR

	Symbols	Jelölések	Bezeichnungen	Symboles	Jména	Označenia	Oznaczenia	Позначення
	IP protection	IP védelem	IP-Klasse	protection IP	IP krytí	IP ochrana	Stopień ochrony IP	Клас IP-захисту
	light reactive, only illuminates in the dark	fényérzékelő lámpa, csak sötétben világít	mit Helligkeitssensor, leuchtet nur im Dunkeln	l'appareil est muni d'un photodétecteur, il ne se manifestera que s'il est plongé dans l'obscurité	se světelným senzorem, svítí pouze ve tmě	so svetelným senzorem, svieti iba v tme	z czujnikiem oświetlenia, świeci tylko w ciemności	оснащений сутінковим світловим вмикачем, включається тільки при зниженні інтенсивності освітлення
	indirect light	indirekt fény	mit indirektem Licht	à lumière indirecte	s nepřímým světlem	s nepriamym svetlom	ze światłem pośrednim	з непрямим освітленням
	backlight effect	háttérfény	Hintergrundlichteffekt	effet de contre-jour	efekt podsvícení	efekt podsvietenia	efekt podświetlenia	ефект підсвічування
	wood	fa	Holz	bois	dřevo	Drevo	Drewno	дерево
	rope	kötél	Seil	corde	lano	lano	lina	мотузка
	2 in 1	kettő az egyben	2 in 1	2 en 1	2 v 1	2 v 1	2 w 1	2 в 1
	adjustable height shank	állítható magasság	höhenverstellbarer Schaft	avec tige de taille réglable	rameno s nastavitelnou výškou	rameno s nastavitelnou výškou	ga (podstawa) z możliwością ustawienia wysokości	можливість регулювання по висоті
	socket light version	konnektorba dugható kivitel	Steckdosenleuchten-Version	Design plug-in	verze světla do zásuvky	verzia svetla do zásuvky	wersja z gniazdem	модель світлового гнізда
	USB input	USB bemenet	USB-Eingang	Port USB	USB vstup	USB vstup	port USB	вхід USB
	wireless charger	vezeték nélküli töltő	kabelloses Ladegerät	chargeur sans fil	bezdrátová nabíječka	bezdrôtová nabíjačka	ładowarka bezprzewodowa	бездротовий зарядний пристрій
	timer function	időzítő funkció	mit einer Zeitfunktion	avec fonction de temps	s časovačem	s časovačom	z funkcją timera	з функцією таймера
	night light function	éjszakai funkció	Nachtfunktion	fonction nuit	funkce nočního světla	funkcia nočného svetla	Funkcja światła nocnego	функція нічника
	memory function	memória funkció	Speicherfunktion	fonction mémoire	funkce paměť	funkcia pamäte	Funkcja pamięci	функція пам'яті



# KEY OF SYMBOLS • JELMAGYARÁZAT • ZEICHENERKLÄRUNG



	Simboluri	Označavanje	Oznake	Oznake	Символи	Simboliai	Simboli	Sümbolid
	Protecția IP	IP zaštita	IP zaštita	IP zaštita	с IP защита	IP klasė	IP aizsardzība	IP kaitse
	cu sensor, luminează doar în întineric	osetljiv na svetlost, svetli samo u mraku	osjetljiv na svjetlost, svijetli samo u mraku	občutljivo na svetlobo, sveti le v temi	реагира на светлина, светва само, когато е тъмно	reaguoja į šviesą, užsidega tik tamsoje	reāģējošs uz gaismu, apgaismo tikai tumsā	valgusreaktiivne, valgustab vaid pimedas
	cu lumină indirectă	sa indirektnim svetlom	s neizravnim svjetlom	s posredno svetlobo	с индиректна светлина	su netiesiogine šviesa	ar netiešu gaismu	kaudvalgusega
	efect iluminare de fundal	pozadinsko osvetljenje	efekt pozadinskog svjetla	učinek osvetlitve	ефект на подсветка	foninio apšvietimo efektas	aizmugurapgaisojuma efekts	tagantvalgustuse efekt
	lemn	drven	drvo	les	дърво	medis	koksne	puit
	frânghie	конопац	uže	vrv	въже	virvė	virve	kõis
	2 în 1	2 u 1	2 u 1	2 v 1	2 в 1	Du viename	Divi vienā	Kaks-ühes
	suport cu înălțime reglabilă	podesiva visina stabla	podesivi krak	nastavljiv nosilec	стълб с променлива височина	reguliuojamo aukščio strypas	regulējams turētāja augstums	reguleeritava kõrgusega kinnitustang
	versiune cu fasung	verzija sa grlom za lampu	verzija s grlom za svjetiljku	različica z okovom žarnice	тип на цокъла	kontaktligzdā iespraužamu gaismekļu versija	lizdo lempos versija	lambipesaga versioon
	Intrare USB	USB ulaz	USB utor	USB vhod	USB вход	USB įvestis	USB ieeja	USB-sisend
	incărcător wireless	bežični punjač	bežični punjač	brežični polnilec	безжично зарядно устройство	belaidis įkroviklis	bezvadu lādētājs	juhtmeta laadija
	cu temporizator	sa vremenskom funkcijom	s vremenskom funkcijom	s časovno funkcijo	с функция за време	su laiko funkcija	ar laika funkciju	ajafunktsiooniga
	Funcție lumina de noapte	funkcija nočno svetlo	funkcija nočnog svjetla	nočna funkcija	функция нощна светлина	naktinio apšvietimo funkcija	nakts apgaismojuma funkcija	õine funktsioon
	Funcție de memorie	funkcija pamćenja	funkcija memorije	pomnilna funkcija	функция памет	atminties funkcija	atmiņas funkcija	mālu funktsioon

# COLOURS • SZÍNEK • FARBEN

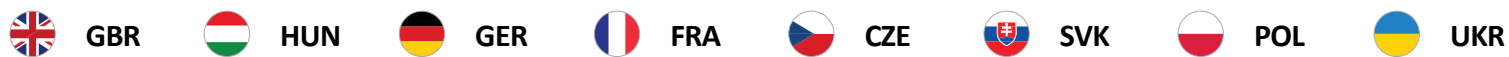

beech	bükk	Buche	hêtre	buk	buk	buk	бук
beige	bézs	Beige	beige	Bežová	béžová	Beżowy	беж
black	fekete	Schwarz	noir	černá	čierna	czarny	чорний
chrome	króm	Chrome	chrome	chromová	chrómová	chrom	хромовий
gold	arany	Gold	dorée	zlatá	zlatá	złoty	золотий
grey	szürke	Grau	gris	šedá	šedá	popielaty	сірий
matte black	matt fekete	Mattschwarz	noir mat	matná černá	matná čierna	czarny matowy	матово-чорний
rose	rózsa	Rosa	rose	růžová	ružová	różowy	рожевий
satin chrome	szatin króm	Satin-Chromfarbig	chrome satiné	hedvábně lesklá chro- mová	saténová chrómová	chrom satyna	сатиново хромовий
silver	ezüst	Silber	argent	stříbrná	strieborná	srebrny	срібний
tinted colour	füst színű	Rauchfarbig	fumée	dýmová barva	dymová	przydymiony	димчастий
transparent	átlátszó	transparent	transparent	průhledná	priehľadná	przezroczysty	прозорий
white	fehér	Weiss	blanc	bílá	biela	biały	білий



fag	bukva	bukva	bukev	бук	buko	dižskābardis	pöök
bej	bež	bež	bež	бежов	smėlio	bėšs	beež
negru	crno	crno	črno	черен	juoda	melns	must
crom	hrom	krom	krom	хром	chrominė	hroms	kroom
auriu	zlatno	zlatno	zlato	златен	auksinė	zelta	kuldne
gri	sivo	sivo	sivo	сив	pilka	pelēks	hall
mat negru	mat crno	mat crno	mat črno	мат-черен	matinė juoda	matēti melns	matt must
trandafir	roza	roza	roza	розов	rožinė	sārts	roos
crom satin	satēnasti hrom	satēnasti krom	satēnast krom	сатенен-хром	atlaso chrominė	satīna hroms	satiin-kroom
argintiu	srebrno	srebrno	srebrno	сребърен	sidabrinė	sudraba	hõbe
fumuriu	boje dima	indigo plava	barva dima	прозращо кафяво	su atspalviu	tonēta krāsa	toonitud värv
transparent	providan	proziran	prozorno	прозрачен	skaidri	caurspīdīgs	lābipaistev
alb	belo	bijelo	belo	бял	balta	balts	valge

# CONTENTS • TARTALOMJEGYZÉK • INHALTSVERZEICHNIS

Art. number	Name	Page
Cikkszám	Név	Oldal
Art. nummer	Name	Seite

2029	Nilfgard	39
2068	Lychee	43
2069	Lychee	43
2081	Solo	32
2082	Solo	32
2083	Solo	32
2084	Solo	33
2085	Solo	33
2086	Solo	33
2090	Bruno	43
2145	Ariel	45
2146	Ariel	45
2150	Spot relight	31
2151	Spot relight	31
2196	Aristeo	41
2197	Aristeo	41
2240	Flint	42
2241	Flint	42
2242	Flint	42
2243	Flint	42
2249	Triton	20
2280	Heimdall	27
2281	Heimdall	27
2282	Pumpkin	44

Art. number	Name	Page
Cikkszám	Név	Oldal
Art. nummer	Name	Seite

2283	Pumpkin	44
2289	Indigo	16
2290	Rasmus	21
2291	Rasmus	21
2292	Indigo	16
2293	Indigo	17
2294	Indigo	17
2295	Lydia	44
2296	Lydia	44
2310	Draco	40
2671	Prudence	6
2672	Prudence	6
2678	Shaun	34
2679	Shaun	34
2680	Shaun	34
2681	Shaun	34
2682	Shaun	35
2683	Shaun	35
2684	Shaun	35
2685	Shaun	35
2686	Shaun	36
2687	Shaun	36
2688	Shaun	36
2689	Shaun	36

Art. number	Name	Page
Cikkszám	Név	Oldal
Art. nummer	Name	Seite

2690	Shaun	36
2691	Shaun	36
2692	Shaun	37
2693	Shaun	37
2932	Herkules	23
2934	Horus	39
2937	Stregobor	23
2957	Eucalyptus	11
3014	Nayara	25
3084	Quince	26
3143	Tatjana	28
3144	Tatjana	28
3145	Tatjana	28
3146	Achilles	20
3147	Farfalle	14
3148	Farfalle	14
3149	Farfalle	14
3150	Farfalle	15
3189	Ursula	7
3190	Ursula	7
3200	Sigurd	29
3659	Cesario	29
5256	Ocean	26
5258	Acantha	4

Art. number	Name	Page
Cikkszám	Név	Oldal
Art. nummer	Name	Seite

5259	Acantha	4
5260	Acantha	4
5267	Casimir	24
5268	Casimir	24
5269	Casimir	24
5270	Daryl	13
5271	Daryl	13
5272	Daryl	13
5274	Coco	37
5275	Coco	37
5276	Coco	37
5280	Yordana	10
5358	Aisha	8
5366	Malcolm	22
6890	Fulvia	29
6899	River	9
6905	Aztec	22
6955	Piero	8

## IMPRINT • IMPRESSZUM • IMPRESSUM

### English

Colour and pattern discrepancy are possible. We are entitled to change the pattern.  
We don't bear the responsibility of the printing failure.

### Magyar

Szín és minta eltérés lehetséges. A minta változtatás jogát fenntartjuk!  
Az esetleges nyomdai hibákért elnézésüket kérjük és azokért felelősséget nem vállalunk.

### Deutsch

Farbe und Musterunterschied ist möglich. Wir halten das Recht von Musteränderung aufrecht.  
Vor die eventuellen Druckfehler bitten wir um Entschuldigung und vor die Fehler können wir die Verantwortung nicht übernehmen.

Grafikai munkák: Visionext Reklámstúdió  
Nyomdai munkák: Keskeny és Társai 2001 Kft.

# CONTACT • ELÉRHETŐSÉGEINK • KONTAKT

## CENTRE/KÖZPONT/ZENTRALE



### Magyarország/Hungary

RÁBALUX HEAD OFFICE  
RÁBALUX VILÁGÍTÁSTECHNIKA ZRT.  
VILÁGÍTÁSTECHNIKA GYÁRTÁS ÉS FORGALMAZÁS/  
LIGHTING PRODUCTION AND DISTRIBUTION

9027 Győr, Körtefa u. 5.  
Tel.: +36 96 526 716  
E-mail: info@rabalux.com  
www.rabalux.com

## AFFILIATES/LEÁNYVÁLLALATOK/ZWEIGSTELLEN



### Bulgaria

РАБАЛУКС ЕООД / RABALUX EOOD  
ул. "Андрей Николов" №15,  
1111 София,  
България  
Тел./Факс: +359 2 936 00 97  
E-mail: infobg@rabalux.com  
www.rabalux.bg



### Croatia

RABALUX RASVIJETA d.o.o.  
Ulica grada Gospića 1a  
10000 Zagreb  
Tel.: +385 1 652 80 66  
E-mail: infocro@rabalux.com  
www.rabalux.hr



### Czech Republic

RABALUX CZ Svítidla s.r.o.  
Kaštanová 141/a, 617 00 Brno,  
Česká Republika  
Tel.: +420 739 665 322  
E-mail: infocz@rabalux.com  
www.rabalux.cz



### Hungary

Rabalux Magyarország Kft.  
Magyarország  
9027 Győr,  
Körtefa u. 5.  
Tel.: +36 96 526 716  
E-mail: infohu@rabalux.com  
www.rabalux.hu



### Lithuania, Latvia, Estonia

UAB „Rabalux Baltic“  
Bičiulių g. 29,  
LT-14182 Bukiškis,  
Vilniaus r. Lietuva  
Tel.: +370 6161 3066  
E-mail: infobaltic@rabalux.com  
www.rabalux.lt



### Poland

Rabalux Sp. z o.o.  
ul. Sołtysia 119, 40-750 Katowice,  
Polska  
Tel.: +48 32 254 61 34  
E-mail: infopl@rabalux.com  
zamowienia@rabalux.com  
www.rabalux.pl



### Romania

SC RABALUX SRL  
Cluj-Napoca, str. Fabricii,  
nr. 93-103, jud. CLUJ  
Romania  
cod postal: 400632  
Tel.: +40 264 456 040  
E-mail: infofo@rabalux.com  
www.rabalux.ro



### Serbia

Rabalux SRB d.o.o.  
Autoput br.20  
11080 Beograd –  
Zemun, Srbija  
Mob: + 381 60 444 3977;  
Tel.: +381(0)11 2013 986  
E-mail: infofo@rabalux.com  
www.rabalux.rs



### Slovakia

RABALUX SK. Svetidlá, s.r.o.  
Alžbetínske nám. 328,  
929 01 Dunajská Streda,  
Slovenská Republika  
Tel.: +421 31 551 54 04  
E-mail: infofo@rabalux.com  
www.rabalux.sk



### Ukraine

ТОВ Рабалукс,  
вул. Рилєєва 4, м. Ужгород,  
Україна, 88017  
тел.: +38 0312 64 04 00,  
моб.тел.: +38 067 310 05 20  
E-mail: infofo@rabalux.com  
www.rabalux.ua

## OFFICIAL RESELLERS/MEGBÍZOTT VISZONTELADÓK/BEAUFTRAGTE WIEDERVERKÄUFER



### Germany

Jens Stolte Leuchten  
GmbH & Co.KG  
Am Rischfeld 36  
39164 Wanzleben - Börde  
Tel.: +49 (0) 39204 915080  
E-mail: info@ostfale.com  
www.rabalux.de



### Slovenia

Lagea d.o.o.  
Brezina 19c  
8250 Brežice  
Republika Slovenija  
Tel.: +386 70 292 70 20  
E-mail: elmatis@lagea.si



### Greece

ANASTASIADI SA  
1km Katerini-Ganohora Road,  
Katerini, 60100  
Tel.: +30 2351039757  
E-mail: eshop@anastasiadi.gr  
B2C SITE: www.anastasiadi.gr  
B2B SITE: www.anastasiadib2b.gr



### Greece

S.MELISSOURGOS CO OE  
8 Kourtiou St,  
11146 Galatsi,  
Tel.: +0030 2102136040  
E-mail: info@melissourgos.com.gr  
melissourgos.com.gr



### Portugal

STORM LIGHT,LDA  
Rua António Pereira Vidal Xavier nº9,  
3750-802 Valongo do Vouga,  
Tel.: 234 661 068  
E-mail: geral@storm-light.pt  
www.storm-light.pt



### Spain

STYLO LIGHTING SL  
Ptda Madrigueres Sud,  
60b, 03700, Denia,  
Alicante  
Tel.: (+34) 965781527  
E-mail: stylo@stylolighting.com  
www.stylolighting.com



### Finland

Focus Interiors Oy  
Kuusipolku 35,  
37150 Nokia  
Tel.: +358 (0)10 3270 520  
E-mail: info@focusinteriors.fi  
www.focusinteriors.fi