

2022 / 2023

 **TRIO**  
LIGHTING FOR YOU





CATALOGUE  
2022 / 2023





## Intelligente Lichtsteuerung · smart lighting control

contrôle d'éclairage intelligent · slimme lichtregeling · control de iluminación inteligente · controllo intelligente dell'illuminazione · control inteligent al iluminatului · älykäs valaistuksen ohjaus · Inteligentne sterowanie światłem

44 - 59



## Leuchtenfamilien & Kombinationen · Families & coordinates

Familles & coordonnés · Families & combinaties · Familias & coordinados · Famiglie & coordinati · Famillii & Coordinate · Tuoteperheet & yhdistettävät tuotteet · Rodzinne orawy & kombinacje

60 - 191

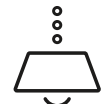

## Pendelleuchten & Kronen · Pendants & chandeliers

Lustres & suspensions · Hanglampen & kroonluchters · Colgantes y Lámparas · Lampadari e sospensioni · Lustre si pendule · Riippu- & kruunu · Wiszące i żyrandole

192 - 245

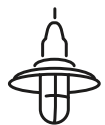

## Leuchten im Vintage Stil · Vintage style luminaires

Luminaire style Vintage · Armaturen in Vintage stijl · Lámparas vintage · Apparecchi stile vintage · Corpuri de iluminat vintage · Vintage valaisimet · Lampy w stylu vintage

246 - 295



## Wand- und Deckenleuchten · Wall & Ceiling lamps

Applique & plafonniers · Wandlampen & plafonnières · Apliques y plafones · Applique e plafoniere · Plafoniere si aplice · Seinä- & katto · Sufitowe i ścienne

296 - 419

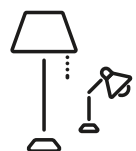

## Steh- und Tischleuchten · Table- & floor lamps

Lampes de table & lampadaires · Tafel- & vloerlampen · Sobremesas y lámparas de pie · Lampade da tavolo e piantane · Veioze si lampadare · Pöytä- & lattia · Stołowe i podłogowe

420 - 497



## Spotserien · Spots

Spotterie · Spots · Focos · Faretti · Spoturi · Spotit · Reflektorki

498 - 529



## DUOline Schienensystem (230 V) · track system (230 V)

Système de voie à deux phases (230 V) · 2-fase-spoorsysteem (230 V) · Sistema de rieles en 2 fases (230 V) · Sistema a binario bifase (230 V) · Sistem de piste cu 2 faze (230 V) · 2-vaihekiskojärjestelmä (230 V) · 2-fazowy system prowadnic (230 V)

530 - 553



## Einbauleuchten · Recessed spots

Spots encastrés · Inbouwspots · Focos empotrables · Faretti incasso · Spoturi incastrate · Upotetut spotit · Oprawy wbudowane

554 - 571

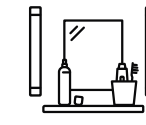

## Badezimmerleuchten · Bathroom lighting

Éclairage salle de bains · Badkamer verlichting · Iluminación de cuarto de baño · Illuminazione per bagno · Iluminat baie · Kylpyhuone valaistus · Oświetlenie łazienkowe

572 - 605



## Leuchtmittel · Light sources

Ampoules · Lichtbronnen · Fuentes de luz · Lampadine · Becuri · Valonlähteet · Źródła światła

606 - 615



## Spezifikationen · Specifications

Spécifications · Specificaties · Especificaciones · Specifiche · Specificații · Tekniset tiedot · Specyfikacje

624 - 653



## Kontakte · Contact

Contact · Contact · Contactar · Contatto · Contact · Yhteydenotto · Kontakt

654 - 655

# LIGHTING FOR YOU



(FR)

**Chers clients et partenaires commerciaux,**

Un environnement de vie dans lequel vous vous sentez confortable est une pièce de qualité de vie !

Nous dernières tendances d'éclairage montrent comment les lieux de vie peuvent être individuellement conçus et élégamment éclairés. Qu'il soit classique ou moderne, chaleureux et naturel, puriste ou glamour - laissez-vous inspirer !

Enjoy browsing through our new catalogue!

(NL)

**Beste klanten en zakenpartners,**

Een leefomgeving, waarin u zich comfortabel voelt, vormt een stukje levenskwaliteit!

Onze nieuwste verlichtingstrends tonen hoe leefruimtes individueel ontworpen en verfijnd verlicht kunnen worden. Of het nu klassiek of modern, warm en natuurlijk, purist of betoverend is - laat inspireren!

Geniet van grasduinen doorheen onze nieuwe catalogus!



(D)

**Liebe Kund\*innen und Geschäftspartner\*innen,**  
eine Wohnumgebung in der man sich wohlfühlt, ist ein Stück Lebensqualität!

Unsere neuesten Leuchten-Trends zeigen, wie Wohnbereiche individuell gestaltet und anspruchsvoll ausgeleuchtet werden können. Ob klassisch oder modern, warm und natürlich, puristisch oder glamourös – lassen Sie sich inspirieren!

Viel Vergnügen beim Durchstöbern unseres neuen Kataloges!

(GB)

**Dear customers and business partners,**

A living environment in which you feel comfortable is a piece of quality of life!

Our latest lighting trends show how living areas can be individually designed and sophisticatedly illuminated. Whether classic or modern, warm and natural, purist or glamorous - let yourself be inspired!

Enjoy browsing through our new catalogue!



(ES)

**Queridos clientes y socios,**

¡un ambiente en el que se sientan cómodos es parte vital de la calidad de vida!

Nuestras últimas tendencias en iluminación muestran como se pueden diseñar individualmente los ambientes e iluminarlos de forma sofisticada. Ya sea de forma clásica o moderna, cálida y natural, purista o glamorosa - ¡inspírate!

¡Disfruta de nuestro nuevo catálogo!

(IT)

**Cari clienti e partner commerciali,**

Un ambiente in cui ci si sente a proprio agio è un componente essenziale della qualità della vita!

Le nostre ultime tendenze in fatto di illuminazione mostrano come gli spazi abitativi possano essere progettati in modo personalizzato e illuminati in modo sofisticato. Classico o moderno, caldo e naturale, purista o glamour: lasciatevi ispirare! Divertitevi a sfogliare il nostro nuovo catalogo!

(RO)

**Dragi clienți și parteneri de afaceri,**

Un mediu de viață în care vă simțiți confortabil este parte de calitatea vieții! Ultimele noaste tendințe în iluminat arată cum zonele de locuit pot fi proiectate individual și iluminate sofisticat. Clasic sau modern, cald și natural, purist sau fastuos - lăsați-vă inspirați!

Bucurați-vă răsfoind noul nostru catalog!

(FI)

**Hyvät asiakkaat ja yhteistyökumppanit.**

Asuinympäristö, jossa tunnet olosi mukavaksi, on osa elämänlaatua! Viimeisin valaistustrendimme näyttää, kuinka olohuoneet voidaan suunnitella yksilöllisesti ja valaista hienostuneesti. Klassista tai modernia, lämmintä ja luonnollista, vähäeleistä tai yllälistä - anna itsesi inspiroitua!

Nauti uuteen kuvastoomme tutustumisesta!

(PL)

**Szanowni Klienci i Partnerzy Handlowi,**

Mieszkanie, w którym czujemy się komfortowo, to element jakości życia!

Nasze najnowsze trendy oświetleniowe pokazują, jak można indywidualnie projektować i oświetlać pomieszczenia mieszkalne. Klasyczne lub nowoczesne, ciepłe i naturalne, purystyczne lub efektowne - pozwólcie się zainspirować!

Zapraszamy do przeglądania naszego nowego katalogu!





# SERIENÜBERSICHT

Family overview · Aperçu par famille · Overzicht per familie · Vista general por familia ·  
Panoramica per famiglia · Prezentare pe familii de produse · Perheen yleiskuvaus · Przegląd rodziny

AARON	46	BERLIN	477	CLAAS	430	DOLOMITE	566	GRANBY	444	LACAL	209	MELBY	51	PHOENIX	334	SALERNO	79	TOKYO	362
ADRIAN	406	BISCUIT	345	CLAPTON	502	DONNA	478	GRANT	211	LACAPO	392	MELVIN	395	PIERA	584	SALINAS	90	TOMMY	552
ADRIANO	401	BLAZE	86	CLARIMO	578	DOWNEY	325	GRIFFIN	52	LANA	407	MICHAEL	522	PIET II	485	SALSA	310	TOSH	274
AGRA	272	BODRUM	355	CLARK	434	DURBAN	200	GROOVY	304	LANCE	474	MIGUEL	394	PIRIN	566	SAMURAI	364	TOULON	403
AICK	210	BOLDER	387	CLAYTON	214	ECCO	418	HARPER	96	LAON	412	MIKO	363	PLANT	271	SANDRINA	188	TRACY	437
ALEGRO	208	BOLSA	576	CLEO	378	EDGE	88	HARRIS	262	LARA	292	MINSK	235	PLATON	400	SANNA	290	TRADITIO	158
ALICIA	172	BOOLAN	237	CLERMONT	218	EDWARD	469	HEDDA	284	LEON	508	MITA	356	POLLY	492	SANTO II	451	TRAJAN	206
ALINO	417	BRAD	251	COLIN	242	ELEMENT	383	HENK II	476	LEVISTO	520	MONZA	456	POLO	492	SEASONS	374	TRAY	136
AMSTERDAM	486	BRADLEY	250	COLINA	409	ELISA	182	HENLEY	265	LIÈGE	473	MOONY	370	PONTE	435	SEDONA	312	TRINITY	400
ANDREUS	384	BRANTFORD	446	COLINO	282	ELMAU	278	HOLLY	238	LIGARA	412	MORRISON	199	PRIMO	407	SEIKO	362	TUBULAR	204
ANGELO	594	BULLET	352	CONCHA	399	ELSA	229	HOSTEL	118	LILLY	410	MOTEL	433	PRONTO	496	SEQUENCE	66	TUCSON	313
ANTIBES	548	BURTON	110	CONCRETE	524	EMERALD	480	HOTEL	122	LINE	386	NAGANO	367	PURA	405	SHANGHAI	441	UMBERTO	603
APART	602	CALAIS	236	CONDUS	605	FABIO	582	HOUSTON	525	LINO	590	NALIDA	56	PURE	166	SHOGUN	364	VALENTE	178
ARAGON	416	CALCIO	462	CONNOR	231	FERNANDO	342	HYDRA	322	LIVIA	227	NANDOR	428	QUEBEC	443	SIGNA	189	VAPORE	174
ARANGO	450	CAMDEN	104	CONO	404	FIGO	59	IBIS	120	LORELEY	239	NAPOLI	156	QUINTA	372	SIMEO	415	VARIO	488
ARGENTINA	439	CAMILLA	599	COOKIE	344	FILIGRAN	467	ICARO	471	LORENA	176	NARCOS	466	RADIATOR	544	SOLA	438	VENTURA	479
ARINO	390	CAMILLUS	550	CORBIE	331	FILO	138	INDIRA	320	LORENZO	592	NIKOSIA	186	RADO	489	SORRENTO	94	VERONA	459
ARIZONA	450	CAMPO	404	CORD	293	FISHERMAN	295	INGA	280	LOUIS	393	NORIAKI	365	RAMON	419	SPIRELLI	184	VERUS	326
ARVIN	319	CANDELA	234	CORE	558	FLETCHER	162	IRVINE	314	LUCERNA	232	NURIA	72	RAVEN	330	SPLIT	453	VIEW	596
ARY II	482	CANNES II	426	CORTEZ	228	FLEXO	496	IVAR	266	LUGANO	346	OAKLAND	77	RAY	579	STAMINA	241	VIOLA	243
ASCARI	574	CARBONADO	408	CRISTO	478	FORESTER	270	JASMIN	294	LUGO	300	OKINAWA	361	REPOSA	373	STEAM	528	VISTA	58
AURA	556	CARICO	518	CROSS	148	FRANCIS	74	JASPER	165	LUIGI	382	ONTARIO	230	RILA	564	SUBARA	359	WACO	332
AURORA	378	CARLO	398	CRYSTEL	351	FRANKLIN	62	JIMMY	552	LUIS II	480	ONYX	224	ROBIN	180	SWEETY	190	WALES	396
AVA	487	CARRERA	76	CUADRO	388	FRED	413	JIVE	80	LUMINA	212	OSAKA	360	ROCCO	580	SYDNEY	78	WANDA	385
AVUS	308	CASSIO	422	CUBE	396	FREDDY	240	JOHANN	291	LUNAR	366	OXFORD	324	RODERIC	488	TAILOR	249	WINONA	317
BAJO	244	CAYA	298	CURL	202	FRODENO	601	JOOST II	476	LUPO	493	PAGO	506	RODRIGO	264	TAJO	497	XAVI	604
BALDO	386	CENTO	341	CURTIS	389	FYNN II	481	JORDAN	381	LYON	108	PALI	376	ROMA	411	TAMIL	140	YAVA	309
BALINI	170	CESAR	369	CURVA	371	GALE	306	JUDITH	286	MACAU	203	PAMIR	560	ROMINO II	238	TANDORI	427	ZAGROS	562
BANGKOK	440	CHARIVARI	70	DAKOTA	468	GANADO	316	JURA	568	MADISON	194	PANTILON	57	RONDO	82	TANJA	290	ZANDOR	134
BARON	132	CHARLESTON	311	DAVI II	483	GARDA	116	KAGAWA	358	MADRAS	268	PAOLO	600	ROPE	287	TAURUS	500	ZAZOU	410
BARONESS	130	CHARLY	56	DEACON	102	GAYA	258	KAZAN	460	MARIO	382	PAPER	245	ROTIN	286	TENALI	273	ZENIA	598
BARRIE	448	CHICO	406	DELHI	254	GIADA	593	KENAI	570	MARLEY	510	PARIS II	431	ROUBAIX	544	TEXEL	472	ZEUS	340
BELA	150	CHIRON	226	DIALLO	160	GIANNI	575	KERALA	100	MARRIOT	380	PAROS	547	ROXIE	145	THEATRO	597	ZORRO	397
BELFAST	92	CHIROS	379	DIAMO	54	GIRONA	338	KHAN	252	MARTA	402	PAVIA	454	RUBY	329	THIAGO	48	ZUCCA	244
BELL	260	CHRIS	452	DIEGO	242	GONZALO	368	KIMI	494	MATS II	484	PEACOCK	354	RUNA	285	TILLII	482		
BELLARI	98	CINZIA	577	DISCALGO	142	GOTHAM	288	KOLIAN	586	MATTIMO	588	PEREZ	436	RUSTICA	152	TIRIAC	308		
BERGAMO	458	CITIZEN	50	DIVO	402	GRANADA	302	KORBA	276	MELA	216	PERRY	495	SABIA	424	TITUS	328		

# PENDELLEUCHTEN & KRONEN

Pendants & chandeliers · Lustres & suspensions · Hanglampen & kroonluchters · Colgantes y Lámparas · Lampadari e sospensioni · Lustre si pendule · Riippu- & kruunu · Wiszące i żyrandole

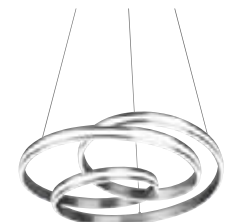

NURIA 72



MACAU 203

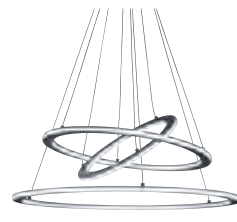

DURBAN 200



AARON 47

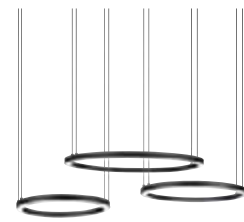

MORRISON 199



OAKLAND 77



FRANCIS 74



CARRERA 76



TRAY 136



FRANKLIN 65

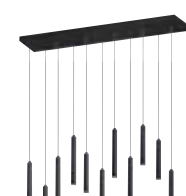

TUBULAR 204



MADISON 194



CLERMONT 218



MARLEY 220



RONDO 82



SEQUENCE 67



BLAZE 86



TRAJAN 206



SALINAS 90



EDGE 88



GRANT 211



AICK 210



BELFAST 93



HARPER 96



KERALA 101



MARLEY 222



DEACON 103

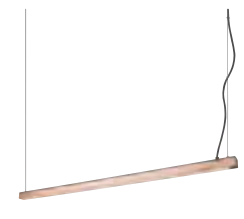

BELLARI 98



ALEGRO 208



CURL 202



CHARIVARI 70



SALERNO 79



LACAL 209



FREDDY 240



LEVISTO 240



STAMINA 241

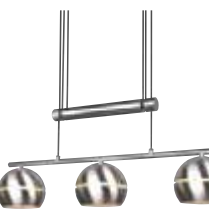

FLETCHER 162



FILO 138



ZANDOR 135



BARON 132



BARONESS 130



JASPER 165



HOLLY 238



# PENDELLEUCHTEN & KRONEN

Pendants & chandeliers · Lustres & suspensions · Hanglampen & kroonluchters · Colgantes y Lámparas · Lampadari e sospensioni · Lustre si pendule · Riippu- & kruunu · Wiszące i żyrandole

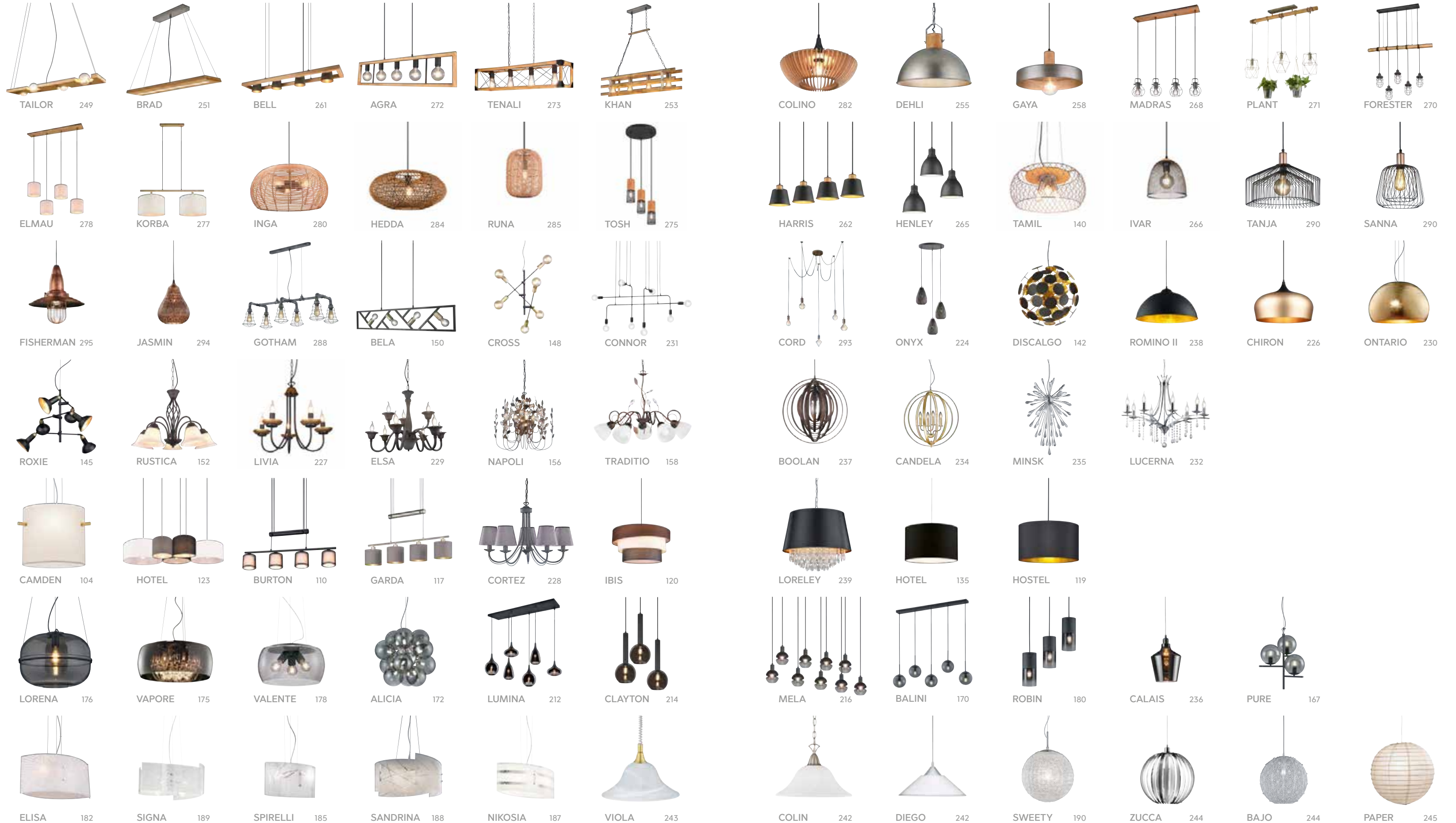



# DECKENLEUCHTEN

Ceiling lamps · Plafonniers · Plafonnières · Plafones ·  
Plafoniere · Plafoniere · Kattvalaisimet · Plafony



CAYA 298



NURIA 72



FRANCIS 74



CARRERA 76



GALE 306



AARON 46



WINONA 317



SEDONA 312



OAKLAND 77



JIVE 80



SALSA 310



YAVA 309



RONDO 82



AVUS 308



CITIZEN 50

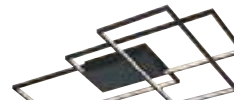

THIAGO 48



HYDRA 322



DOWNEY 325



CHARLESTON 312



IRVINE 314



SALINAS 90



GANADO 316



BLAZE 86



HARPER 96



TUCSON 313



SEDONA 312



GROOVY 304

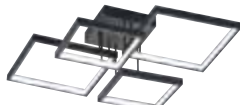

SORRENTO 94

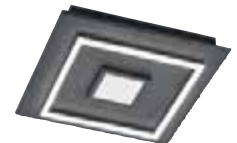

CORBIE 331



BELFAST 92

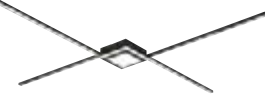

OXFORD 324



TIRIAC 308



MELBY 51



ARVIN 319



INDIRA 320



BELLARI 150



MARLEY 510

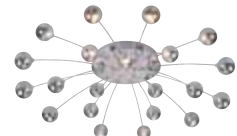

BULLET 352

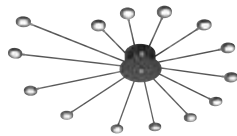

PEACOCK 354



BODRUM 355



SYDNEY 78

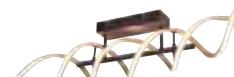

SEQUENCE 66



CHARIVARI 70



LUGO 300



GRANADA 303



DEACON 102



FRANKLIN 62



TRAY 136



GIRONA 338



BARON 132



ZANDOR 134



BARONESS 130



COOKIE 344



BISCUIT 345



FERNANDO 342



# DECKENLEUCHTEN

Ceiling lamps · Plafonniers · Plafonnières · Plafones ·  
Plafoniere · Plafoniere · Kattvalaisimet · Plafony

											
VERUS 326	OKINAWA 361	TOKYO 362	MIKO 363	OSAKA 360	NORIAKI 365	MITA 356	SUBARA 359	KAGAWA 358	RUBY 329	NALIDA 56	SEIKO 362
											
CESAR 369	LUNAR 366	SAMURAI 364	SHOGUN 364	CHARLY 56	GONZALO 368	TITUS 328	GRIFFIN 52	WACO 332	PHOENIX 334	CENTO 341	ZEUS 340
											
CAMDEN 104	LUGANO 348	HOTEL 122	HOTEL 124	LUGANO 346	DIAMO 54	MOONY 370	GARDA 116	HOSTEL 118	IBIS 120		
											
BURTON 112	ALICIA 172	CRYSTEL 351	LORENA 176	VALENTE 178	VAPORE 174	DISCALGO 142	CROSS 148	DIALLO 160	PALI 376	SEASONS 374	
											
TAILOR 249	BRAD 251	TENALI 273	COLINO 282	KERALA 100	BELL 260	KHAN 252	HEDDA 284	INGA 280	TAMIL 140	KORBA 276	ELMAU 278
											
JOHANN 291	REPOSA 373	NAPOLI 156	ROXIE 146	TRADITIO 158	QUINTA 372	RUSTICA 152	CHIOS 379	ELISA 182	NIKOSIA 186	ADRIAN 406	SANDRINA 188
											
SPIRELLI 184	COLINA 409	SIGNA 189	PRIMO 407	CHICO 406	CARBONADO 408	LANA 407	SWEETY 190	LILLY 410	CLAPTON 503	CURVA 371	



# WANDLEUCHTEN

Wall lamps · Appliques · Wandlampen · Appliques ·  
Appliques · Lämpje de perete · Seinävalaisimet · Scienne



BELFAST 92



MIGUEL 394



ADRIANO 401



CARLO 398



WALES 396



LOUIS 393



LACAPO 392



VISTA 58



ZANDOR 134



ZORRO 397



MELVIN 395



CONCHA 399



FIGO 59



RAVEN 330



MARLEY 513



MARIO 382



LUIGI 382



JORDAN 381



ELEMENT 383



SUBARA 359



TRINITY 400



PLATON 400



CUBE 396



ROMA 411



ZAZOU 410



KAZAN 460



EDWARD 469



CUADRO 368



SEQUENCE 66



LUGO 300



MARRIOT 380



CASSIO 422



ANDREUS 384

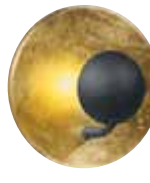

AURORA 378



CHIROS 379



CLEO 378

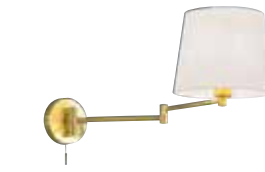

LYON 108



PURE 168



CURTIS 389



WANDA 385



KERALA 100



PALI 376



ARINO 390



BRADLEY 250



BRAD 251



KHAN 252



GAYA 258



TRADITIO 159



LUCERNA 232

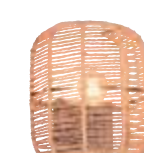

RUNA 285



HOTEL 128



BALDO 386



BOLDER 387



LINE 386



DIALLO 160



GOTHAM 288



CAMPO 404



CONO 404



TOULON 403



ELISA 182



COLINA 409



SANDRINA 188



SPIRELLI 184



NIKOSIA 186



PURA 405



CARBONADO 408



SIGNA 189



DIVO 402



MARTA 402



SWEETY 190



# SPOTSERIEN

Spots · Spotterie · Spots · Focos · Faretti · Spoturi · Spotit · Reflektorki



CLAPTON 503



NARCOS 504



MARLEY 514



TAURUS 500



LEON 508



PAGO 506



BURTON 114



MICHAEL 522



CONCRETE 524



LEVISTO 520



CARICO 518



ROXIE 526



HOUSTON 525



STEAM 528



BELL 260



MARLEY 510



MADRAS 268



TOSH 274



DEHLI 256



LEVISTO 413



LAON 412



FRED 413



LIGARA 412



WANDA 385

## 2-PHASEN-SCHIENENSYSTEM

2-phase track system · Système de voie à deux phases · 2-fase-spoorsysteem · Sistema de rieles en 2 fases · Sistema a binario bifase · Sistem de piste cu 2 faze · 2-vaihekiskojärjestelmä · 2-fazowy system prowadnic



RADIATOR 544



ROUBAIX 544



LEON 544



MARLEY 546



ANTIBES 548



TOMMY 552



DIALLO 548



TOSH 548



CAMILLUS 550



PANEL 550

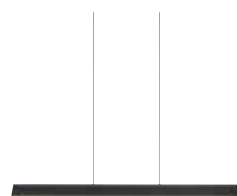

PAROS 547



MARLEY 546



ONTARIO 548



JIMMY 552



HOSTEL 552



HOTEL 552



HOTEL 552



HOSTEL 553



# TISCHLEUCHTEN

Table lamps · Lampes de table · Tafellampen · Sobremesas ·  
Lampa da tavolo · Veioze · Pöytävalaisimet · Lampy stołowe



SABIA 424



CASSIO 422



TANDORI 427



LYON 108



PARIS II 431



NANDOR 428



HOSTEL 118



HOTEL 129



MATS II 484



PIET II 485



GARDA 116



BURTON 110



LORENA 176



VAPORE 174



ALICIA 172



ROBIN 180



KERALA 101



TAILOR 249



INGA 280



ELMAU 278



KORBA 276



SEQUENCE 67



BLAZE 86



EDGE 88



TEXEL 472



CHARIVARI 71



FRANKLIN 62



RONDO 82



SORRENTO 94



SYDNEY 78



BERLIN 477



PURE 168



JOOST II 476



HENK II 476



DONNA 478



VENTURA 479



EMERALD 480



LUIS II 480



LARA 292



TRADITIO 158



RUSTICA 154



CRISTO 476



FYNN II 481



ARY II 482



TILL II 482



DAVI II 483



AVA 487



RADO 489



RODERIC 488



AMSTERDAM 486



VARIO 488



PAVIA 454



MONZA 456



POLO 492



CALCIO 462



NARCOS 505



CURTIS 490



BERGAMO 458



POLLY 492



LUPO 493



MARLEY 464



ROXIE 145



JASPER 165



PERRY 495



FLETCHER 162



DIALLO 161



KIMI 494



TOSH 275



PRONTO 496



FLEXO 496



TAJO 497

# STEHLEUCHTEN

Floor lamps · Lampadaires · Vloerlampen · Lámparas de pie · Piantane · Lampadare · Lattiavalaisimet · Lampy podłogowe



# STEHLEUCHTEN

Floor lamps · Lampadaires · Vloerlampen · Lámparas de pie · Piantane · Lampadare · Lattiavalaisimet · Lampy podłogowe



NURIA 73



JIVE 80



RONDO 83



SORRENTO 94



SALERNO 79



SYDNEY 78

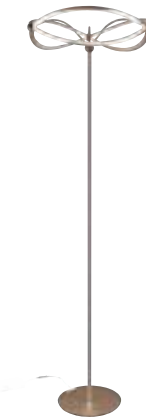

CHARIVARI 71



SEQUENCE 67



BLAZE 86



EDGE 88



BELLARI 98



KERALA 101



PANTILON 57



FRANKLIN 62



BRANTFORD 446



GRANDBY 444



BARRIE 448



QUEBEC 443



ARGENTINA 439



SOLA 438



BANGKOK 440

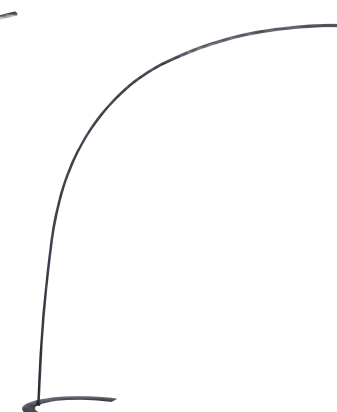

SHANGHAI 441



SPLIT 453



SANTO II 451



ARIZONA 450



CHRIS 452



ARANGO 450



RUSTICA 154



CALCIO 462



BERGAMO 458



VERONA 459



FILIGRAN 467



MONZA 456



PAVIA 454



FRANKLIN 64



KAZAN 460



FLETCHER 162



MARLEY 464



ROXIE 145



JASPER 165



ICARO 471



EDWARD 469



NARCOS 466



DAKOTA 468



FREDDY 470



# BADEZIMMERLEUCHTEN H<sub>2</sub>O

Bathroom lighting · Éclairage salle de bains · Badkamer verlichting · Iluminación de cuarto de baño ·  
 Illuminazione per bagno · Iluminat baie · Kylpyhuone valaistus · Oświetlenie łazienkowe



ASCARI 574



CINZIA 577



CAMILLA 599



APART 602



CLARIMO 578



CONDUS 605



UMBERTO 603



FRODENO 601



PAOLO 600



BOLSA 576



ANGELO 594



RAY 579



BOLSA 576



VIEW 596



GIANNI 575



THEATRO 597



LINO 590



PIERA 584



ROCCO 580



FABIO 582



MATTIMO 588



KOLIAN 586



XAVI 604



LORENZO 592



GIADA 593



ZENIA 598

# EIN- UND UNTERBAULEUCHTEN

Recessed and cabinet lightings · Eclairages encastrés et éclairages sous armoire ·  
 Inbouwverlichtingen en verlichtingen onder de kastjes · Luces empotrables y luces para la parte inferior  
 del armario · Lampade da incasso e lampade sottopensili · Lumini încastrate și lumini sub dulap ·  
 Upotettavat valaisimet ja kaapinalusvalaisimet · Oprawy wpuszczane oraz oprawy podszafkowe



AURA 556



CORE 558



ZAGROS 562



ZAGROS 562



PAMIR 560



PAMIR 560



RILA 564



RILA 564



JURA 568



JURA 568



DOLOMITE 566



PIRIN 566



KENAI 570



SIMEO 415



ARAGON 416



ALINO 417



RAMON 419



ECCO 418





FRANKLIN  
Seite / page 62

ⒼⒺ The colour black is noble and timeless. Black is also the colour of individuality, aesthetics and elegance. As well-placed eye-catchers, these expressive lighting ideas visibly enhance the immediate surroundings, adding an extravagant touch to living space

ⒻⒻ La couleur noire est noble et intemporelle. Le noir est également la couleur de l'individualité, de l'esthétique et de l'élégance. En tant qu'accroches bien placées, ces idées d'éclairage expressif améliorent visiblement les alentours immédiats, en ajoutant une touche extravagante aux lieux de vie.

ⒼⒼ De kleur zwart is prachtig en tijdloos. Zwart is ook de kleur van individualiteit, esthetiek en elegantie. Als goed geplaatste blikvangers versterken deze expressieve verlichtingsideeën de onmiddellijke omgeving, een extravagant vleugje toevoegend aan leefruimtes.



ⒼⒻ Die Farbe Schwarz ist edel und zeitlos. Schwarz ist auch die Farbe der Individualität, der Ästhetik und der Eleganz. Als wohlplatziertes Blickfang werten diese ausdrucksstarken Lichtideen das unmittelbare Umfeld sichtbar auf, und verleihen Wohnräumen einen extravaganten Touch.

ⒼⒻ El color negro es noble y atemporal. Es el color de la individualidad, la estética y la elegancia. Estas expresivas ideas de iluminación, que funcionan como focos de atención bien establecidos, realzan visiblemente el entorno y añaden un toque extravagante a los ambientes.



ⒻⒻ Il colore nero è nobile e senza tempo. Il nero è anche il colore dell'individualità, dell'estetica e dell'eleganza. Queste idee illuminotecniche, ben posizionate, valorizzano visibilmente l'ambiente circostante, aggiungendo un tocco stravagante agli spazi abitativi.

ⒼⒼ Negru este o culoare nobilă și eternă. Negru este de asemenea culoarea individualității, esteticii și eleganței. Ca elemente bine plasate de atragere a atenției, aceste idei de iluminat expresive îmbunătățesc vizibil imediata vecinătate, adăugând o nuanță extravagantă spațiilor de locuit.

ⒻⒻ Musta on värinä jalo ja ajaton. Musta on myös yksilöllisyyden, estetiikan ja eleganssin väri. Hyvinsijoitettuina katseenvangitsijoina nämä vaikuttavat valaistusideat rikastavat välitöntä ympäristöään antaen asuinympäristöille yllättävää tunnelmaa.

ⒼⒼ Kolor czarny jest szlachetny i ponadczasowy. Czerni to także kolor indywidualności, estetyki i elegancji. Te ekspresyjne pomysły oświetleniowe przyciągają wzrok, są dobrze rozmieszczone i wyraźnie podkreślają najbliższe otoczenie, dodając ekstrawagancki akcent przestrzeniom mieszkalnym.





Ⓓ Besonders charakteristisch für diesen Trend ist die Kombination aus schwarzen und goldfarbenen Design-Elementen. Die elegant geschwungenen Formen verleihen diesen Leuchten einen besonderen Charme, und Wohnräumen eine stilvolle und romantische Note.

Ⓔ Particularly characteristic of this trend is the combination of black and gold-coloured design elements. The elegantly curved shapes give these luminaires a special charm and living spaces a stylish and romantic touch.

Ⓕ Une caractéristique particulière de cette tendance est la combinaison d'éléments de conception noirs et dorés. Les formes élégamment courbes donnent à ces luminaires un charme particulier et aux espaces de vie une touche élégante et romantique.



Ⓖ In het bijzonder kenmerkend voor deze trend is de combinatie van zwart en goud-gekleurde designelementen. De elegant gebogen vormen bezorgen deze verlichtingstoestellen een bijzondere charme en leefruimtes een stijlvolle en romantische toets.

Ⓗ La combinación de elementos de diseño de color negro y dorado es una característica especial de esta tendencia. Las formas curvas y elegantes le aportan un encanto especial a estas luminarias y un toque sofisticado y romántico a los ambientes.

Ⓙ Particolarmente caratteristica di questa tendenza è la combinazione di elementi di design neri e dorati. Le forme elegantemente incurvate conferiscono a questi lampadari un fascino particolare e agli spazi abitativi un tocco elegante e romantico.

Ⓚ În mod special caracteristic acestei tendințe este combinația de elemente de design în culorile negru și auriu. Aceste forme elegant curbate dau acestor piese de iluminat un farmec special și spațiilor de locuit o atingere romantică și stilată.

Ⓔ Erityisen luonteenomaista tälle trendille on mustan ja kullanväristen elementtien yhdistely. Elegantisti kaartuvat muodot antavat valaisimille erityistä viihtäisyyttä ja asuinympäristöille tyylikkään, romanttisen silauksen.

Ⓖ Szczególnie charakterystyczne dla tego trendu jest połączenie elementów designu w kolorze czarnym i złotym. Elegancko zakrzywione kształty nadają tym opracom szczególnego uroku, a przestrzeniom mieszkalnym stylowy i romantyczny akcent.







IT Uno stile basato sulla semplicità e sulla chiarezza. Il minimalismo si riflette soprattutto in un linguaggio ridotto di colori e forme. Il design è diretto e senza tempo, e la giocosità è deliberatamente evitata. Condizioni perfette per un ambiente discreto ed espressivo.

FI Yksinkertaisuudelle ja selkeydelle pohjaava tyyli. Minimalismi äyvä ennenkaikkeaa pelkistetyssä väir- ja muotomaailmassa. Design on suoraviivainen ja ajaton, leikkisyyttä on tarkoituksella vältetty. Täydelliset olosuhteet hillittyyn ja vaikuttavaan ilmapiiriin.

RO Un stil bazat pe simplitate și claritate. Minimalismul este reflectat mai presus de toate printr-un limbaj redus de culoare și formă. Designul este direct și atemporal, iar spontaneitatea este deliberat evitată. Condiții perfecte pentru o ambianță discretă și expresivă.

PL Styl oparty na prostocie i przejrzystości. Minimalizm odzwierciedla się przede wszystkim w zredukowanym języku koloru i formy. Projekt jest prosty i ponadczasowy, celowo unika się zabawy. Idealne warunki, aby stworzyć dyskretną i wyrazistą atmosferę.



TRAY  
Seite / page 136

DE Ein Stil, der auf Einfachheit und Klarheit beruht. Der Minimalismus zeigt sich vor allem in einer reduzierten Farb- und Formensprache. Das Design ist geradlinig und zeitlos, auf Verspieltes wird bewusst verzichtet. Perfekte Voraussetzungen für ein dezentes und ausdrucksstarkes Ambiente.

GB A style based on simplicity and clarity. Minimalism is reflected above all in a reduced language of colour and form. The design is straightforward and timeless, and playfulness is deliberately avoided. Perfect conditions for a discreet and expressive ambience.

FR Un style basé sur la simplicité et la clarté. Le minimalisme est surtout reflété dans un langage réduit de couleur et de forme. Le design est simple et intemporel, et le côté ludique est délibérément omis. Des conditions parfaites pour une ambiance discrète et expressive.

NL Een stijl gebaseerd op eenvoud en helderheid. Minimalisme wordt vooral weergegeven in een omgezette taal van kleur en vorm. Het design is ongecompliceerd en tijdloos en speelsheid wordt doelbewust vermeden. Perfecte voorwaarden voor een discrete en expressieve sfeer.

ES Un estilo basado en la simplicidad y la claridad. El minimalismo se refleja sobre todo en la reducción del lenguaje del color y la forma. El diseño es directo y atemporal, y se evita deliberadamente el carácter lúdico. Las condiciones son perfectas para un ambiente discreto y expresivo.

PAVIA  
Seite / page 454





34

Der moderne Stil ist schlicht, cool und zeitlos. Leuchten-Designs mit kunstvollen Gläsern, setzen wirkungsvolle Statements. Die rauchfarbene Transparenz lässt das Licht zu etwas ganz Besonderem werden, und verbindet moderne Leichtigkeit mit elegantem Chic.

The modern style is simple, cool and timeless. Luminaire designs with artistic glass make effective statements. The smoke-coloured transparency turns the light into something very special and combines modern lightness with elegant chic.

Le style moderne est simple, cool et intemporel. Les designs des luminaires en verre artistique font leurs effets. La transparence fumée transforme la lumière en un quelque chose de très spécial et combine clarté moderne et chic élégant.



De moderne stijl is eenvoudig, cool en tijdloos. Verlichtings- toestelontwerpen met artistiek glas zorgen voor indrukwekkende uitdrukkingen. De blauwgrijze transparantie vormt het licht om tot iets zeer bijzonder en combineert moderne helderheid met elegant chic.

El estilo moderno es simple, relajado y atemporal. Los diseños de luminarias con vidrios artísticos son una expresión eficaz. La transparencia de humo coloreado convierte a la luz en algo muy especial y combina la luminosidad moderna con la tendencia elegante.

Lo stile moderno è semplice, fresco e senza tempo. I design delle lampade con vetro artistico producono affermazioni efficaci. La trasparenza color fumo trasforma la luce in qualcosa di molto speciale e combina la leggerezza moderna con l'eleganza chic.

Stilul modern este simplu, cool și neafectat de trecerea timpului. Designul corpurilor de iluminat cu sticlă artistică transmite mesaje eficiente. Transparența în nuanțe fumurii transformă lumina în ceva foarte special și combină ușurința modernă cu eleganța șic.

Moderni tyylit ovat yksinkertaiset, viileät ja ajaton. Taiteellisia lasidesigneja kantavat valaisimet välittävät sanoman tehokkaasti. Savunomainen läpinäkyvyys muuntaa valon erityislaatuiseksi ja yhdistää modernia keveyttä eleganttiin chiciin.

Nowoczesny styl jest prosty, fajny i ponadczasowy. Projekty opraw ze szkłem artystycznym tworzą efektowną ekspresję. Przejroczystość w kolorze dymu zmienia światło w coś wyjątkowego i łączy nowoczesną lekkość z eleganckim stylem.

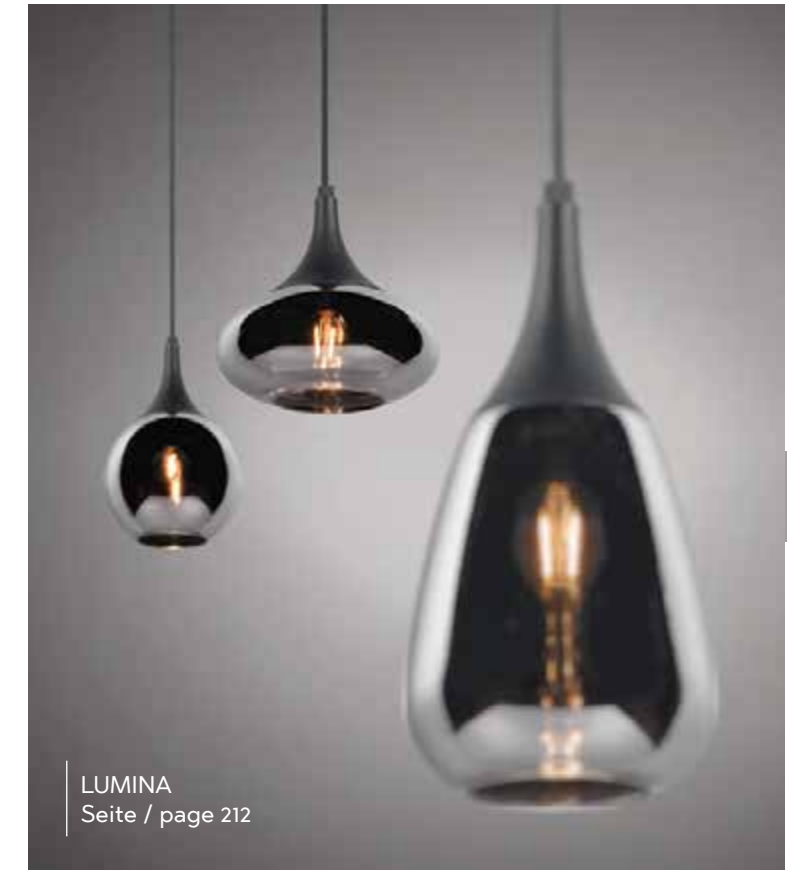





El estilo de las casas de campo se centra en el carácter acogedor. Por lo tanto, la madera es el material que predomina en este popular estilo. Las luminarias hechas de madera maciza, combinadas con elementos de diseño modernos, ofrecen mucha inspiración para nuevas ideas y le brindan a este estilo tradicional un golpe contemporáneo.

Lo stile della casa di campagna si concentra sull'intimità. Pertanto, il legno è il materiale dominante di questo look popolare. Le lampade in legno massiccio, abbinata a elementi di design moderno, offrono numerosi spunti per nuove idee e conferiscono a questo stile tradizionale un tocco di contemporaneità.

Beim Landhausstil steht die Gemütlichkeit im Mittelpunkt. Daher ist Holz das dominierende Material dieses beliebten Looks. Leuchten aus Massivholz, in Kombination mit modernen Design-Elementen, bieten reichlich Inspiration für neue Ideen und geben dieser traditionellen Stilrichtung einen zeitgemäßen Kick.

The country house style focuses on coziness. Therefore, wood is the dominant material of this popular look. Luminaires made of solid wood, combined with modern design elements, offer plenty of inspiration for new ideas and give this traditional style a contemporary kick.

Le style maison de campagne se concentre sur le confort. Par conséquent, le bois est le matériau dominant de ce look à la mode. Les luminaires fabriqués en bois solide, combinés à des éléments décoratifs modernes, offrent beaucoup d'inspiration pour de nouvelles idées et apportent à ce style traditionnel une touche contemporaine.

De landhuisstijl focust op gezelligheid. Bijgevolg is hout het dominante materiaal van deze populaire look. Verlichtingstoestellen gemaakt uit stevig hout, gecombineerd met moderne designelementen, bieden veel inspiratie voor nieuwe ideeën en bieden deze traditionele stijl een hedendaagse stimulans.



KERALA  
Seite / page 100



HARPER  
Seite / page 96

Stilul rustic se concentrează pe confort. Drept urmare, lemnul este materialul preponderent în acest aspect popular. Corpuri de iluminat făcute din lemn masiv, combinate cu elemente moderne de design, oferă multă inspirație pentru idei noi și îi dau acestui stil tradițional un impuls contemporan.

Maalaistyyli keskittyy mukavuuteen. Siksi puu on tämän suosittuun tyyliin hallitseva materiaali. Täyspuusta valmistetut valaisimet yhdistettyinä moderneihin design-elementteihin tarjoavat runsaasti inspiraatiota uusille ideoille ja antavat perinteiselle tyyliille nykyaikaisen silauksen.

Styl wiejskiego domu stawia na przytulność. Dlatego drewno jest dominującym materiałem tego popularnego designu. Oprawy wykonane z litego drewna w połączeniu z nowoczesnymi elementami dają mnóstwo inspiracji dla nowych pomysłów i nadają współczesnego akcentu temu tradycyjnemu stylowi.



Der industrielle Wohnstil ist roh und rustikal. Metall, Stein und unverputzte Ziegelwände zeichnen ihn aus. Leuchten im Vintage-Look schaffen einen lässigen Loft-Charakter, und verleihen dem kühlen Industrie-Style Wohnlichkeit.

The industrial style of living is raw and rustic. Metal, stone and unplastered brick walls characterise it. Vintage-look luminaires create a casual loft character, and lend cosiness to the cool industrial style.

Le style de vie industriel est brut et rustique. Il est caractérisé par le métal, la pierre et les murs en briques apparentes. Les luminaires au look vintage créent un caractère loft décontracté et confèrent de l'intimité au style industriel froid.

Lo stile abitativo industriale è grezzo e rustico. Metallo, pietra e pareti di mattoni non intonacate lo caratterizzano. Le lampade dall'aspetto vintage creano un carattere informale da loft e conferiscono un'atmosfera accogliente al fresco stile industriale.

Modul de viață industrial este brut și rustic. Îl caracterizează metalul, piatra și pereții cu cărămida expusă. Corpuri de iluminat cu aspect vintage creează un caracter informal de mansardă și oferă confort stilului rece industrial.

Industrial-tyylinen elämä on raakaa ja rustiikkista. Metallit, kivi ja rapaamaton tiiliseinä ovat sille luonteenomaisia. Vintage-tyyliset valaisimet luovat rentoa loft-tunnelmaa, ja tuovat kodikkuutta viileään industrial-tyyliin.



DEHLI  
Seite / page 254

De industriële stijl van leven is ruw en rustiek. Metaal, steen en niet-bepleisterde bakstenen muren typeren dit. Verlichtingstoestellen met vintage-look creëren een nonchalant loft-karakter, en verlenen gezelligheid aan de koele industriële stijl.

El estilo industrial es crudo y rústico. Lo caracterizan las paredes de metal, piedra y ladrillo a la vista. Las luminarias de aspecto antiguo crean un carácter casual para los ambientes de pocas divisiones y le aportan calidez al frío estilo industrial.



ROXIE  
Seite / page 145

Przemysłowy styl mieszkania jest prosty i surowy. Charakteryzują go ściany z metalu, kamienia i nieotynkowanej cegły. Oprawy w klasycznym stylu oddają swobodny charakter poddasza i nadają przytulności chłodnym, industrialnym wnętrzą.







RUNA  
Seite / page 285

Ⓣ Dieser aktuelle Wohntrend richtet sich vor allem an trendbewusste Naturliebhaber\*innen. Materialien wie Holz, Korbgeflecht oder Sisal sorgen für ein naturnahes, exotisches Ambiente und vermitteln eine Atmosphäre von Freiheit und Abenteuer.

Ⓣ This current living trend is aimed primarily at trend-conscious nature lovers. Materials such as wood, wickerwork or sisal create a natural, exotic ambience and convey an atmosphere of freedom and adventure.

Ⓣ Cette tendance actuelle d'éclairage est principalement destinée aux amoureux de la nature soucieux de la tendance. Les matériaux comme le bois, la vannerie ou le sisal créent une ambiance naturelle et exotique et apporte une atmosphère de liberté et d'aventure.

Ⓣ Deze huidige leefftrend is vooral gericht op trendbewuste natuurliefhebbers. Materialen zoals hout, vlechtwerk of sisalvezel creëren een natuurlijke, exotische sfeer en brengen een sfeer over van vrijheid en avontuur.

Ⓣ La tendencia actual se enfoca sobre todo en los amantes de la naturaleza. Los materiales como la madera, el mimbre o el sisal crean un ambiente natural y exótico. Además, transmiten un entorno de libertad y aventura.



PLANT  
Seite / page 271

Ⓣ Questa tendenza abitativa attuale si rivolge soprattutto agli amanti della natura attenti alle tendenze. Materiali come legno, vimini o sisal creano un ambiente naturale ed esotico e trasmettono un'atmosfera di libertà e avventura.

Ⓣ Această curentă tendință de trai îi vizează în principal pe iubitorii de natură care urmăresc tendințele. Materiale precum lemnul, ratan sau sisal creează o atmosferă de libertate și aventură.



INGA  
Seite / page 280

Ⓣ Tämänhetkinen asumistrendi on suunnattu pääasiassa trenditietoisille luonnonystäville. Materiaalit, kuten puu, rottinki tai sisali, luovat luonnollisen, eksoottisen ilmapiirin ja henkivät vapautta ja seikkailuntuntua.

Ⓣ Ten aktualny trend mieszkaniowy jest skierowany przede wszystkim do miłośników przyrody. Materiały takie jak drewno, wiklina czy sisal tworzą naturalną, egzotyczną atmosferę i oddają atmosferę wolności i przygody.







Smart Home-Beleuchtung erfreut sich zunehmend, steigender Beliebtheit. Intelligente Lichtsteuerung bietet nicht nur ein Höchstmaß an Komfort und Flexibilität, sie eröffnet auch völlig neue Möglichkeiten der kreativen Lichtgestaltung. Auf diese Weise lassen sich Lebensqualität, Wohnkomfort und Sicherheit auf ein neues Level bringen.

Smart home lighting is becoming increasingly popular. Intelligent lighting control not only offers maximum convenience and flexibility, it also opens up completely new possibilities for creative lighting design. In this way, quality of life, living comfort and safety can be brought to a new level.

La iluminación de casas inteligentes se está volviendo cada vez más popular. El control inteligente de la iluminación no sólo ofrece la máxima comodidad y flexibilidad, sino que también da lugar a posibilidades completamente nuevas para el diseño creativo de la iluminación. De esta manera, la calidad de vida, comodidad y seguridad para vivir pueden alcanzar un nuevo nivel.

L'illuminazione domestica smart sta diventando sempre più popolare. Il controllo intelligente dell'illuminazione non solo offre la massima comodità e flessibilità, ma apre anche nuove possibilità di progettazione creativa. In questo modo, la qualità della vita, il comfort abitativo e la sicurezza possono essere portati a un nuovo livello.

Iluminatul inteligent al locuințelor devine din ce în ce mai popular. Controlul iluminatului inteligent nu numai că oferă maximul de ușurință și flexibilitate, dar de asemenea deschide noi posibilități pentru designul creativ al iluminatului. În acest fel, calitatea vieții, confortul de trai și siguranța pot fi ridicate la un nou nivel.

Get your light connected.



64.000 WEISSTÖNE  
64,000 WHITES

Einstellbare Lichtprogramme · Preset light modes



16 Millionen FARBEN  
16 million COLORS

Dynamische Lichtprogramme · Dynamic light modes



Kotien älyvalaistuksesta on tulossa yhä suosituempaa. Älykäs valonsäätely tarjoaa maksimaalista käytännöllisyyttä ja joustavuutta, sekä avaa täysin uusia mahdollisuuksia luovalle valaistussuunnittelulle. Tällä tavoin elämänlaatu, asuinmukavuus ja turvallisuus voidaan viedä uudelle tasolle.

Intelligentne oświetlenie w domu staje się coraz bardziej popularne. Inteligentne sterowanie oświetleniem oferuje nie tylko maksymalną wygodę i elastyczność, ale także otwiera zupełnie nowe możliwości kreatywnego projektowania oświetlenia. W ten sposób jakość życia, komfort i bezpieczeństwo można przenieść na



trio-lighting.com/wiz

L'éclairage intelligent des maisons devient de plus en plus à la mode. Le contrôle de l'éclairage intelligent offre non seulement un grand confort et une flexibilité maximale, mais ouvrent également de nouvelles possibilités pour une conception d'éclairage créatif. De cette façon, la qualité de vie, le confort de vie et la sécurité peuvent être hissés à un tout autre niveau.

Slimme thuisverlichting wordt meer en meer populair. Intelligente verlichtingsregeling biedt niet enkel maximaal gemak en maximale flexibiliteit, het opent ook volledig nieuwe mogelijkheden voor een creatief verlichtingsdesign. Op deze manier kunnen levenskwaliteit, leefcomfort en veiligheid tot een nieuw niveau gebracht worden.



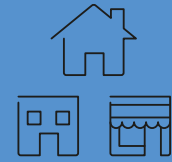

### Mehrere Standorte

Kontrollieren und Steuern von mehreren Standorten gleichzeitig und von überall aus. Ob das eigene Zuhause oder die Ferienwohnung.

### Multiple locations

Control and command multiple locations simultaneously and from anywhere. Whether your own home or your holiday home.

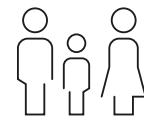

### Mehrere Nutzer

Die Anzahl der Nutzer zur Steuerung der Leuchten kann individuell festgelegt werden.

### Multiple user

The number of persons to control the lights can be set individually.



### Cloud basiert

WiZ verbindet sich mit der Cloud, damit Vorlieben gespeichert, Wünsche geteilt und Updates automatisch generiert werden.

### Cloud based

WiZ connects to the cloud to store preferences, share desires and generate updates automatically.



### WiZ APP

Einfach und schnell installiert. Volle Funktionalität und Flexibilität mit der WiZ App – erhältlich im App Store oder bei Google Play.

Easy and quick to install. Full functionality and flexibility with the WiZ App – available on the App Store or on Google Play.



### WiZ MOTE

Steuerung über die Fernbedienung und Abspeichern von vier favorisierten Lichtmodi möglich.

Control via the remote control and possibility to save four favorite light modes.

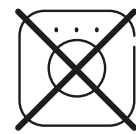

### Keine zusätzliche Bridge erforderlich

Es wird keine zusätzliche Bridge oder Hub für die Steuerung der Leuchten benötigt.

### No additional hub needed

There is no need for an additional bridge or hub to control the lights.



### Mehrere Räume

Alle Leuchten können unterschiedlichen Räumen zugeordnet und präzise gesteuert werden – einzeln oder in Gruppen.

### Several rooms

All lights can be assigned to different rooms and precisely controlled – individually or in groups.

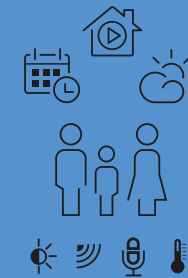

### WiZ MAGIC

Steuerung der Leuchten über Zeitpläne, Sensoren oder einfache Sprachbefehle. Kompatibel mit Amazon Alexa und Google Home.

Control of the lights by time schedules, with sensors or by simple verbal commands. Compatible with Amazon Alexa and Google Home.

### DIMMEN DIMMING



64.000 WEISSTÖNE  
64,000 WHITES

Einstellbare Lichtprogramme · Preset light modes



16 Millionen FARBEN  
16 million COLORS

Dynamische Lichtprogramme · Dynamic light modes



### Wlan Technologie

WiZ nutzt Wlan-Technologie als sichere, unabhängige, kostengünstige und einfach zu installierende Funklösung.

### WiFi technology

WiZ uses Wi-Fi technology as a secure, independent, affordable and easy-to-install wireless solution.

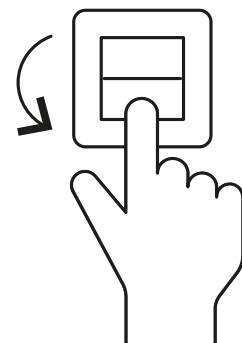

### WiZ CLICK

Einfach und effektiv. Zwei bevorzugte Lichtmodi können über den vorhandenen Lichtschalter bedient werden.

Simple and effective. Two preferred light modes can be operated via the existing light switch.

30 Sekunden zur Installation · 30 seconds to install



Die Lampe installieren  
Install a lamp



Wählen Sie den „Koppeln“ Modus  
Start pairing



3 x EIN / AUS  
3 x ON/OFF



Die Lampe beginnt „blau“ zu blinken und schaltet danach auf weiß  
Light turns blue then goes white



Die Einstellungen sind nun gespeichert, jeder kann zu Hause WiZ nutzen.  
The settings are now saved!  
Now everyone can use WiZ at your home.



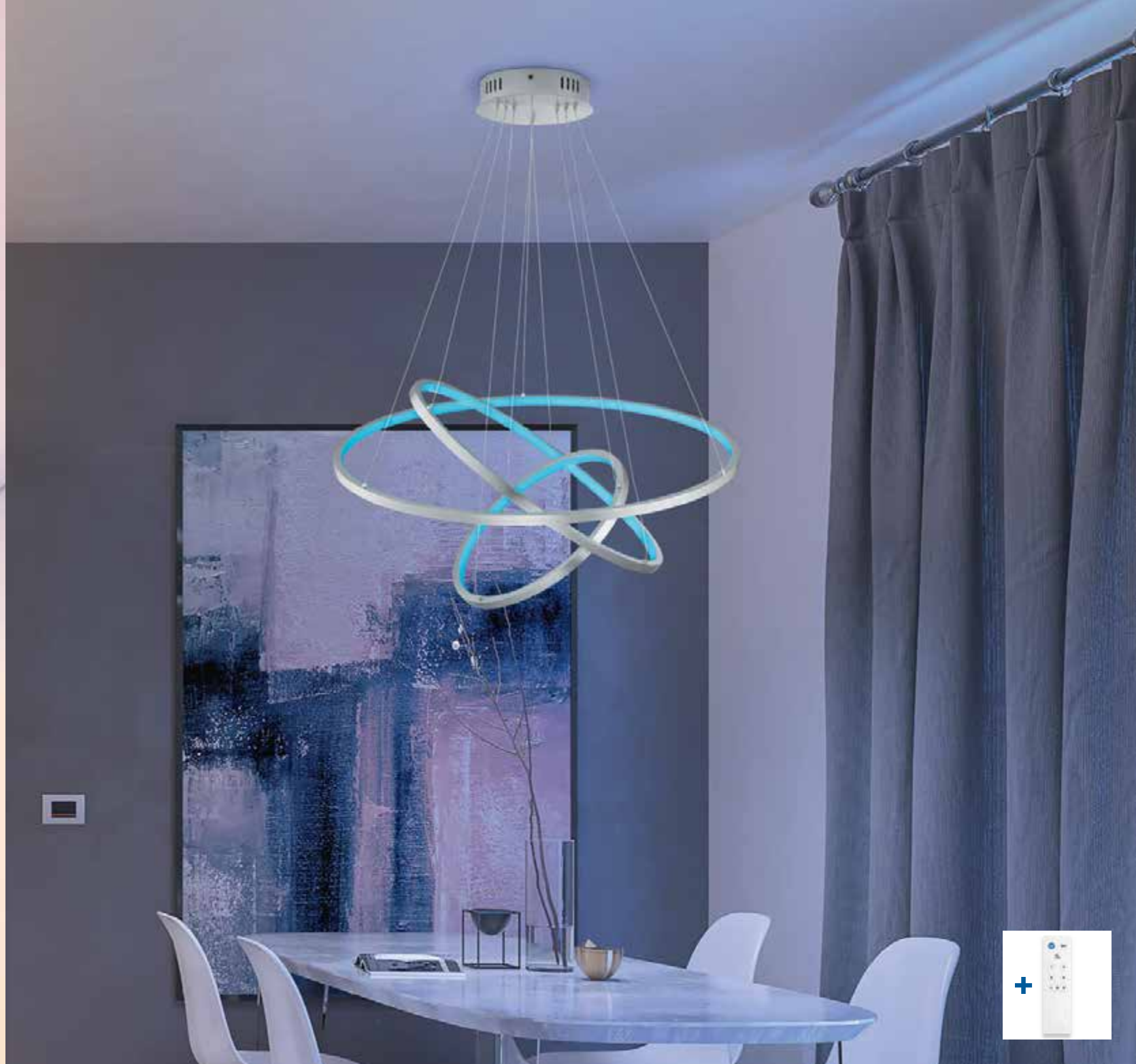
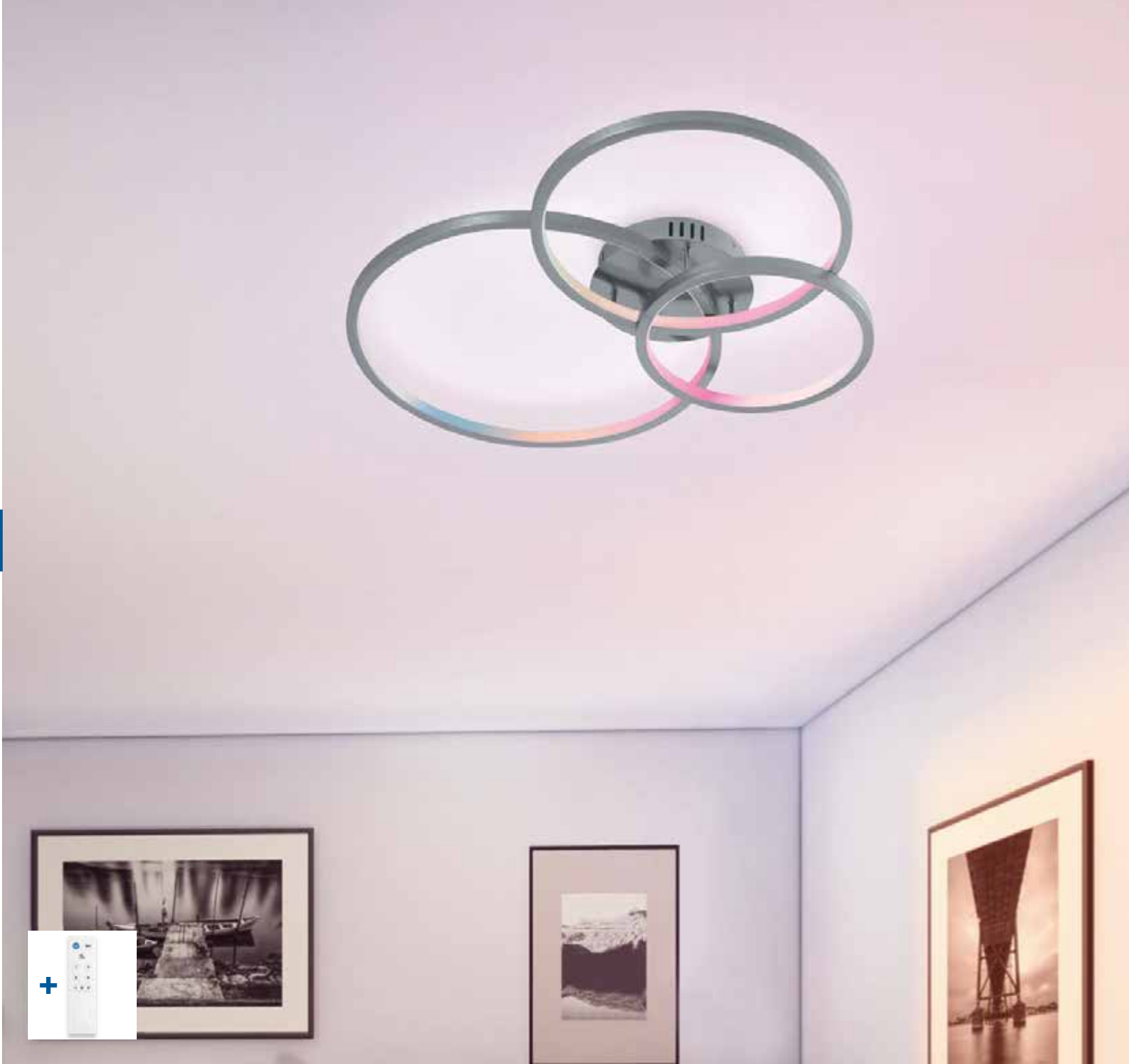

Deckenleuchte · Ceiling lamp  
 ↔ 79 x 64 cm, ↓ 10,5 cm  
 incl. RGBW-LED, 36,5 W  
 4.200 lm, 3.000 - 6.000 K



652710307  
 652710342

# AARON

Metall, Nickel matt oder Anthrazit · metal, nickel mat or anthracite ·  
 metale, nickel mat ou antracite · metaal, nikkell mat of antraciet ·  
 metal, níquel mate o antracita · metallo, nichel opaco o antracite ·  
 metal, nichel mat sau antracit · metalli, harjattu teräs tai antrasiitti ·  
 metal, nikiel mat lub antracyt

## SMART LIGHTING



07 | Nickel matt · nickel mat



42 | Anthrazit · anthracite



Pendelleuchte · Pendant  
 Ø 80 cm, ↓ 150 cm  
 incl. RGBW-LED, 78 W  
 9.200 lm, 3.000 - 6.000 K





352710307  
 352710342



# THIAGO

Metall, Nickel matt oder Anthrazit · metal, nickel mat or anthracite ·  
 metale, nickel mat ou antracite · metaal, nikkel mat of antraciet ·  
 metal, níquel mate o antracita · metallo, nichel opaco o antracite ·  
 metal, nichel mat sau antracit · metalli, harjattu teräs tai antrasiitti ·  
 metal, nikiel mat lub antracyt

## SMART LIGHTING

-  07 | Nickel matt · nickel mat
-  32 | Schwarz matt · black mat

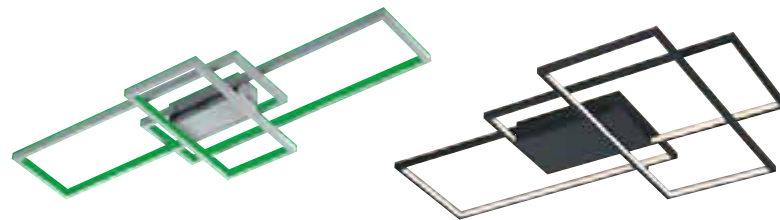

**Deckenleuchte · Ceiling lamp**  
 ↔ 104 x 42 cm, ↑ 8,5 cm  
 incl. RGBW-LED, 36 W  
 3.000 lm, 3.000 - 6.000 K



652610307  
 652610342

**Deckenleuchte · Ceiling lamp**  
 ↔ 114 x 75 cm, ↑ 8,5 cm  
 incl. RGBW-LED, 39 W  
 4.500 lm, 3.000 - 6.000 K



652690307  
 652690342







## CITIZEN

Metall, Nickel matt oder Schwarz matt · metal, nickel mat or black mat ·  
metale, nickel mat ou noir mat · metaal, nikkel mat of mat zwart ·  
metal, níquel mate o estera negra · metallo, nichel opaco o nero opaco ·  
metal, nichel mat sau negru mat · metalli, harjattu teräs tai mattamusta ·  
metal, nikiel mat lub czarny mat

### SMART LIGHTING



Deckenleuchte · Ceiling lamp  
↔ 94,5 x 55 cm, ↑ 8 cm  
incl. 2 x RGBW-LED, 17 W  
max. 2 x 1.900 lm, 3.000 - 5.000 K



651110207  
651110232

07 | Nickel matt · nickel mat

32 | Schwarz matt · black mat

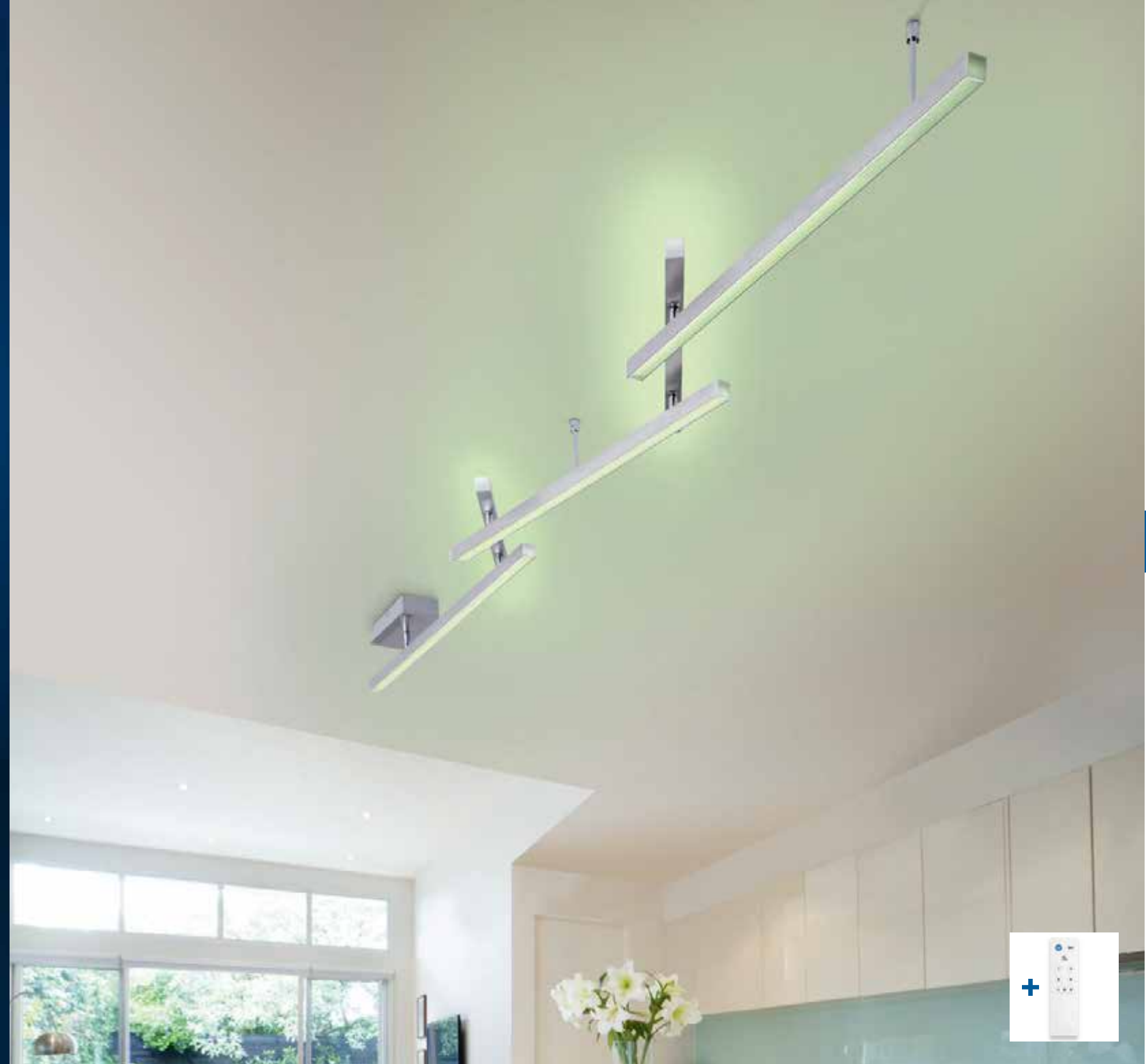

## MELBY

Nickel matt, Acryl · nickel mat, acryl ·  
nickel mat, acryl · nikkel mat, acryl · níquel mate, acrílico ·  
nichel opaco, acrílico · nichel mat, acrilic · harjattu teräs, akryyli ·  
nikiel mat, akryl

Direkte und indirekte Beleuchtung · up and down lighting ·  
point lumineux en haut et en bas · lichtpunt boven en onder ·  
luz de arriba y abajo · luce su e giù · sus și în jos lumina ·  
ylös ja alas valoa · w górę iw dół światło

### SMART LIGHTING

Deckenleuchte · Ceiling lamp  
↔ max. 242 x 10 cm, ↑ 12 cm  
incl. RGBW-LED, 23 W  
max. 2.200 lm, 3.000 - 5.000 K



651210507

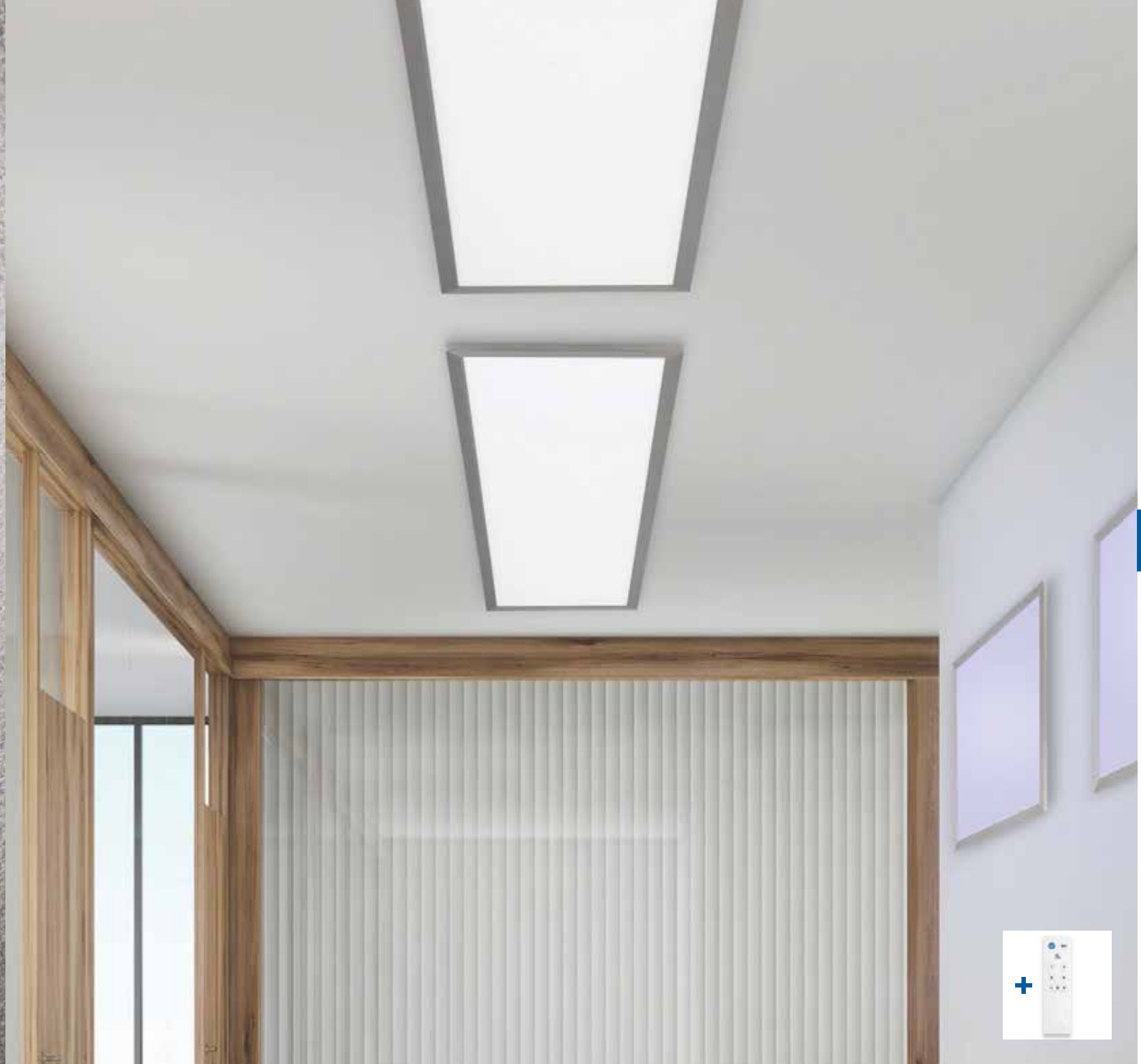

# GRIFFIN

Nickel matt, Acryl · nickel mat, acryl ·  
nickel mat, acryl · nikkell mat, acryl · níquel mate, acrílico · nichel opaco, acrílico ·  
nichel mat, acrílico · harjattu teräs, akryyli · nikiel mat, akryl

## SMART LIGHTING



Deckenleuchte · Ceiling lamp  
Ø 30 cm, ↓ 5 cm  
incl. SMD-LED, 15 W  
1.750 lm, 3.000 - 5.500 K

Deckenleuchte · Ceiling lamp  
Ø 40 cm, ↓ 5 cm  
incl. SMD-LED, 20 W  
2.000 lm, 3.000 - 5.500 K

Deckenleuchte · Ceiling lamp  
Ø 60 cm, ↓ 5 cm  
incl. SMD-LED, 37 W  
4.200 lm, 3.000 - 5.500 K

Deckenleuchte · Ceiling lamp  
↔ 29,5 x 29,5 cm, ↓ 5 cm  
incl. SMD-LED, 15 W  
1.750 lm, 3.000 - 5.500 K

Deckenleuchte · Ceiling lamp  
↔ 39,5 x 39,5 cm, ↓ 5 cm  
incl. SMD-LED, 20 W  
2.300 lm, 3.000 - 5.500 K

Deckenleuchte · Ceiling lamp  
↔ 59,5 x 59,5 cm, ↓ 5 cm  
incl. SMD-LED, 36 W  
4.200 lm, 3.000 - 5.500 K

Deckenleuchte · Ceiling lamp  
↔ 109,5 x 29,5 cm, ↓ 5 cm  
incl. SMD-LED, 37 W  
4.300 lm, 3.000 - 5.500 K



657493007

657494007

657496007

657413007

657414007

657416007

657411107





# DIAMO

Stoff weiß · fabric white ·  
tissu blanc · textiel wit · tela bianco · tessuto bianco ·  
textil alb · tekstiili valkoinen · tkanina biały

**SMART  
LIGHTING**



Deckenleuchte · Ceiling lamp  
Ø 60 cm, ↑ 10 cm  
incl. RGBW-LED, 36 W  
max. 3.400 lm, 3.000 - 5.000 K



651914001



Deckenleuchte · Ceiling lamp  
Ø 75 cm, ↑ 10 cm  
incl. 1 x RGBW-LED, 47 W  
max. 5.500 lm, 3.000 - 5.000 K



651915501





# CHARLY

Acryl, weiß · acryl, white ·  
acryl, blanc · acryl, wit · acrílico, blanco · acrilico, bianco ·  
acrilic, alb · akryyli, valkoinen · akryl, biały

Deckenleuchte · Ceiling lamp  
Ø 50 cm, ↑ 12 cm  
incl. RGBW-LED, 27 W  
max. 3.100 lm, 3.000 - 5.500 K



656010100

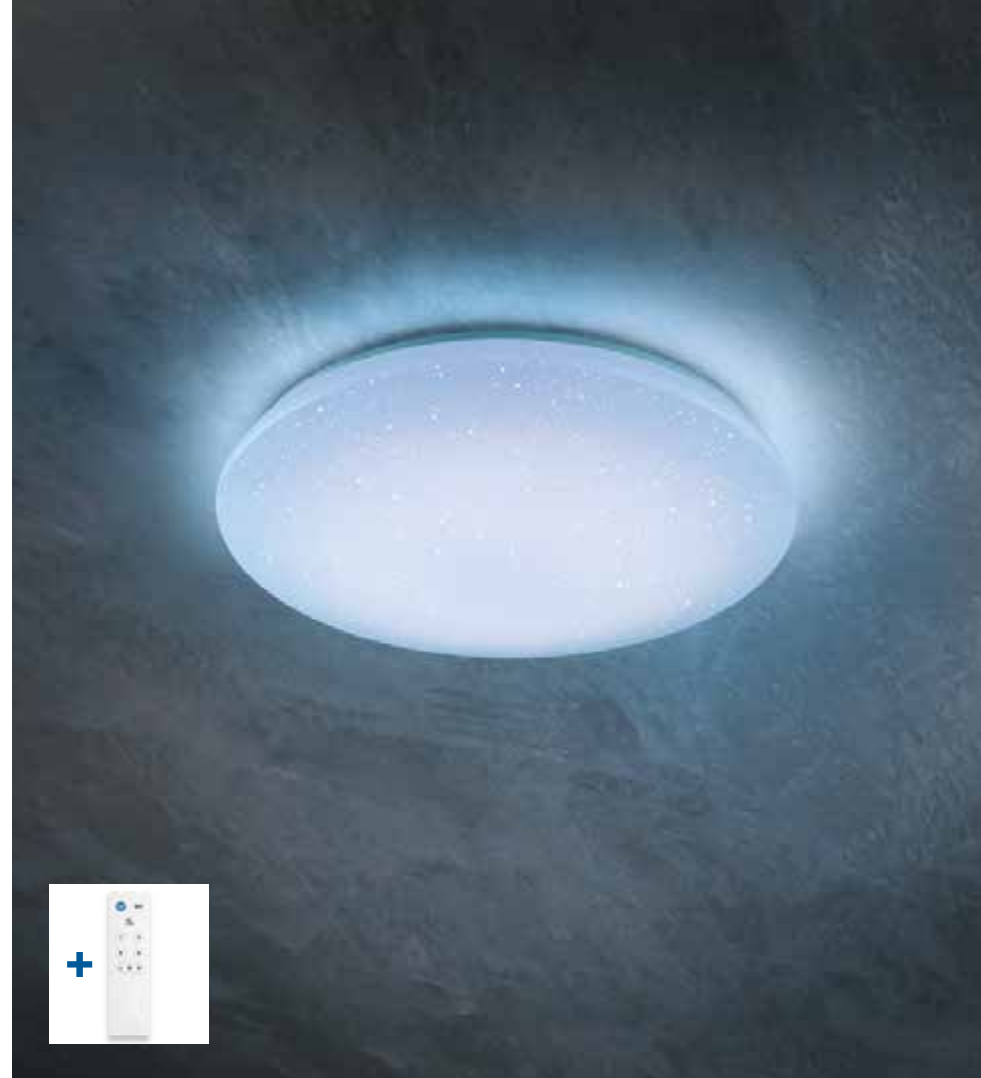

## SMART LIGHTING

# NALIDA

Acryl, weiß · acryl, white ·  
acryl, blanc · acryl, wit · acrílico, blanco · acrilico, bianco ·  
acrilic, alb · akryyli, valkoinen · akryl, biały

Deckenleuchte · Ceiling lamp  
Ø 74 cm, ↑ 10 cm  
incl. RGBW-LED, 40 W  
max. 4.650 lm, 3.000 - 5.500 K



656090100

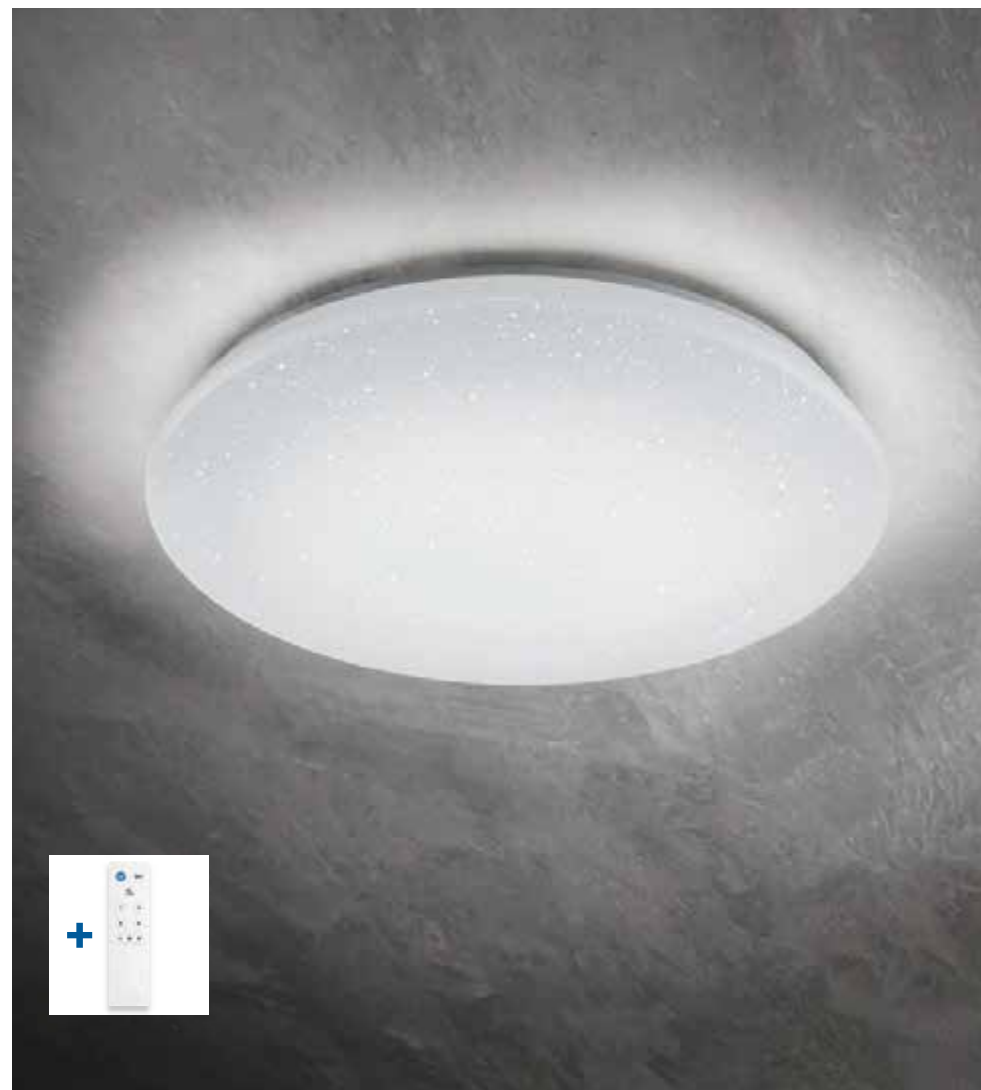

# PANTILON

Acryl, weiß · acryl, white ·  
acryl, blanc · acryl, wit · acrílico, blanco · acrilico, bianco ·  
acrilic, alb · akryyli, valkoinen · akryl, biały

## SMART LIGHTING



Stehleuchte · Floor lamp  
↑ 150 cm, Ø 24 cm  
incl. SMD-LED, 22 W  
2.200 lm, 3.000 - 6.000 K



451850101



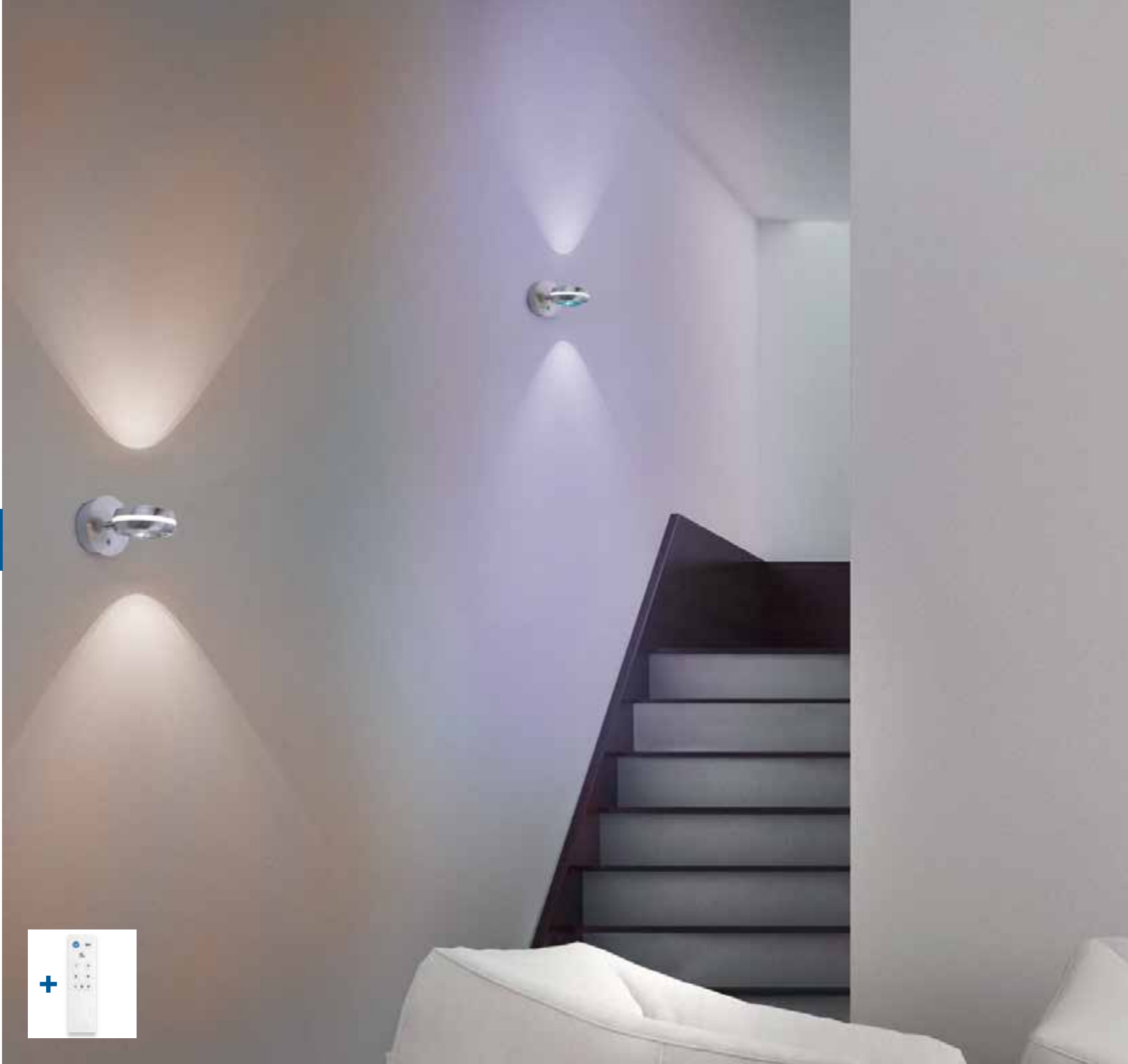

# VISTA

Nickel matt · nickel mat · nickel mat · nikkel mat · níquel mate · nichel opaco · nichel mat · harjattu teräs · nikiel mat

## SMART LIGHTING

Wandleuchte · Wall lamp  
Ø 11 cm, 17,5 cm  
incl. 2 x RGBW-LED, 3,8 W  
2 x 380 lm, 3.000 - 5.000 K



255410207



# FIGO

Metall · metal · metale · metaal · metal · metallo · metal · metalli · metal

## SMART LIGHTING

Wandleuchte · Wall lamp  
↔ 10 x 10 cm, 10 cm  
incl. RGBW-LED, 5,5 W  
700 lm, 3.000 - 6.500 K



253310105  
253310131  
253310132



05 | Aluminium gebürstet · brushed aluminium



31 | Weiß matt · white mat

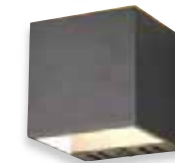

32 | Schwarz matt · black mat



## Leuchtenfamilien & Kombinationen

Families & coordinates  
 Familles & coordonnés  
 Families & combinaties  
 Familias & coordinados  
 Famiglie & coordinati  
 Famillii & Coordonate  
 Tuoteperheet & yhdistettävät tuotteet  
 Rodzinne orawy & kombinacje



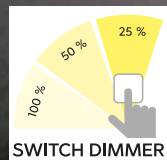

SWITCH DIMMER



2.700 K

3.200 K

4.000 K



# FRANKLIN

Metall · metal · metale · metaal · metal · metallo · metal · metalli · metal

-  **04** | Altmessing · old brass
-  **07** | Nickel matt · nickel mat
-  **08** | Messing matt · brass mat
-  **42** | Anthrazit · anthracite



**Deckenleuchte · Ceiling lamp**  
 Ø 35 cm, ↑ 13 cm  
 incl. 3 x SMD-LED, 8,5 W  
 3 x 1.000 lm, 3.000 K



626510304  
 626510307  
 626510308  
 626510342



**Tischleuchte · Table lamp**  
 ↑ 25 cm, Ø 14 cm  
 incl. SMD-LED, 6 W  
 700 lm, 3.000 K



526510104  
 526510107  
 526510108  
 526510142



**Stehleuchte · Floor lamp**  
 ↑ 181 cm, Ø 35,2 cm, √ 41 cm  
 incl. SMD-LED, 35 W, 4.100 lm  
 incl. SMD-LED, 6,5 W, 650 lm  
 2.700 + 3.200 + 4.000 K



426510204  
 426510207  
 426510208  
 426510242



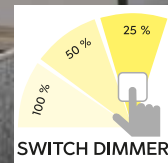
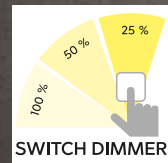

-  **04** | Altmessing · old brass
-  **07** | Nickel matt · nickel mat
-  **08** | Messing matt · brass mat
-  **42** | Anthrazit · anthracite



# FRANKLIN

Metall · metal ·  
metale · metaal · metal ·  
metallo · metal · metalli · metal



**Stehleuchte · Floor lamp**  
 ↑ 133 cm, Ø 23 cm, √ 41 cm  
 incl. SMD-LED, 6,5 W  
 650 lm, 2.700 + 3.200 + 4.000 K



- 426510104
- 426510107
- 426510108
- 426510142



**Pendelleuchte · Pendant**  
 ↑ 95 - 180 cm, Ø 14 cm  
 incl. SMD-LED, 7,2 W  
 835 lm, 3.000 K



- 326510107
- 326510108
- 326510142



**Pendelleuchte · Pendant**  
 ↑ 95 - 150 cm, ↔ 55 x 14 cm  
 incl. 2 x SMD-LED, 7,2 W  
 2 x 835 lm, 3.000 K



- 326510207
- 326510208
- 326510242



**Pendelleuchte · Pendant**  
 ↑ 95 - 150 cm, ↔ 85 x 14 cm  
 incl. 3 x SMD-LED, 7,2 W  
 3 x 835 lm, 3.000 K



- 326510307
- 326510308
- 326510342





# SEQUENCE

Metall, Messing matt, Schwarz matt · metal, brass mat, black mat · métal, laiton mat, noir mat · metaal, messing mat, mat zwart · metal, bronze mate, estera negra · metallo, ottone satinato, nero opaco · metal, bronz mat, negru mat · metalli, mattamessinki, mattamusta · metal, mosiądz mat, czarny mat

Lichtfarbe einstellbar · Adjustable light color

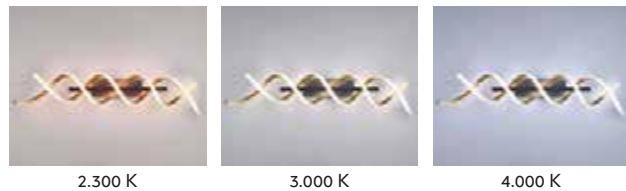

**Wandleuchte · Wall lamp**  
↓ 47 cm, ↔ 13,5 cm, ↗ 20,5 cm  
incl. SMD-LED, 22 W  
2.800 lm, 2.300 + 3.000 + 4.000 K



241810208



**Deckenleuchte · Ceiling lamp**  
↔ 90 x 14,5 cm, ↓ 20,5 cm  
incl. SMD-LED, 41 W  
5.000 lm, 2.300 + 3.000 + 4.000 K



641810208



**Pendelleuchte · Pendant**  
↓ 150 cm, ↔ 105 x 16 cm  
incl. SMD-LED, 45 W  
5.600 lm, 2.300 + 3.000 + 4.000 K



341810208



**Tischleuchte · Table lamp**  
↓ 48,5 cm, Ø 16 cm  
incl. SMD-LED, 20,5 W  
2.600 lm, 2.300 + 3.000 + 4.000 K



541810208



**Stehleuchte · Floor lamp**  
↓ 150 cm, Ø 23 cm  
incl. SMD-LED, 32 W  
4.000 lm, 2.300 + 3.000 + 4.000 K



441810208





## SEQUENCE

Metall, Aluminium gebürstet, Schwarz matt · metal, brushed aluminium, black mat ·  
 métal, aluminium balayé, noir mat · metaal, geborsteld aluminium, mat zwart ·  
 metal, aluminio pulido, estera negra · metallo, alluminio spazzolato, nero opaco ·  
 metal, aluminiu lucios, negru mat · metalli, harjattu alumiini, mattamusta ·  
 metal, aluminium szczotkowane, czarny mat



Lichtfarbe einstellbar ·  
 Adjustable light color



2.300 K

3.000 K

4.000 K



**Wandleuchte · Wall lamp**  
 ↓ 47 cm, ↔ 13,5 cm, ↗ 20,5 cm  
 incl. SMD-LED, 22 W  
 2.800 lm, 2.300 + 3.000 + 4.000 K



241810205



**Deckenleuchte · Ceiling lamp**  
 ↔ 90 x 14,5 cm, ↓ 20,5 cm  
 incl. SMD-LED, 41 W  
 5.000 lm, 2.300 + 3.000 + 4.000 K



641810205



**Pendelleuchte · Pendant**  
 ↓ 150 cm, ↔ 105 x 16 cm  
 incl. SMD-LED, 45 W  
 5.600 lm, 2.300 + 3.000 + 4.000 K



341810205



**Tischleuchte · Table lamp**  
 ↓ 48,5 cm, Ø 16 cm  
 incl. SMD-LED, 20,5 W  
 2.600 lm, 2.300 + 3.000 + 4.000 K



541810205



**Stehleuchte · Floor lamp**  
 ↓ 150 cm, Ø 23 cm  
 incl. SMD-LED, 32 W  
 4.000 lm, 2.300 + 3.000 + 4.000 K



441810205



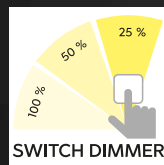

SWITCH DIMMER



**Pendelleuchte · Pendant**  
 Ø 62 cm, ↑ 150 cm  
 incl. SMD-LED, 42 W  
 5.600 lm, 3.000 K



321210107  
 321210108



**Deckenleuchte · Ceiling lamp**  
 Ø 41 cm, ↑ 14 cm  
 incl. SMD-LED, 20 W  
 2.500 lm, 3.000 K



621210107  
 621210108



**Deckenleuchte · Ceiling lamp**  
 Ø 62 cm, ↑ 18 cm  
 incl. SMD-LED, 42 W  
 5.600 lm, 3.000 K



621290107  
 621290108



## CHARIVARI

Nickel matt oder Messing matt · nickel mat or brass mat ·  
 nickel mat ou laiton mat · nikkell mat of messing mat ·  
 níquel mate o bronze mate · nichel opaco o ottone satinato ·  
 nichel mat sau bronz mat · harjattu teräs tai mattamessinki ·  
 nikiel mat lub mosiądz mat



07 | Nickel matt · nickel mat

08 | Messing matt · brass mat



**Tischleuchte · Table lamp**  
 ↑ 50 cm, Ø 41 cm  
 incl. SMD-LED, 26 W  
 2.500 lm, 3.000 K



521210107  
 521210108



**Stehleuchte · Floor lamp**  
 ↑ 175 cm, Ø 52 cm  
 incl. SMD-LED, 31 W  
 4.100 lm, 3.000 K



421210107  
 421210108



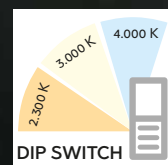

DIP SWITCH



DIP SWITCH

Lichtfarben direkt an der Leuchte einstellbar · Colours directly adjustable at the lamp · Les couleurs de la lumière peuvent être réglées directement sur le luminaire · Lichtkleuren direct instelbaar op de lamp · Tonalidades de luz ajustables directamente en la lámpara · Colori della luce regolabili direttamente sulla lampada · Colori ale luminii reglabile direct de la bec · Valon väri asetettävissa suoraan valaisimesta · Barwy światła można ustawić bezpośrednio na oprawie



Deckenleuchte · Ceiling lamp  
 Ø 59 cm, ↑ 14 cm  
 incl. SMD-LED, 58 W  
 7.000 lm, 2.300 + 3.000 + 4.000 K



626210107  
 626210131  
 626210132



Pendelleuchte · Pendant  
 Ø 60 cm, ↑ 150 cm  
 incl. SMD-LED, 60 W  
 7.200 lm, 2.300 + 3.000 + 4.000 K



326210107  
 326210131  
 326210132



## NURIA

Metall, Acryl · metal, acryl ·  
 metale, acryl · metaal, acryl · metal, acrílico ·  
 metallo, acrilico · metal, acrilic · metalli, akryyli · metal, akryl



Lichtfarbe einstellbar ·  
 Adjustable light color



07 | Nickel matt · nickel mat



31 | Weiß matt · white mat



32 | Schwarz matt · black mat



Stehleuchte · Floor lamp  
 ↑ 150 cm, Ø 35 cm  
 incl. SMD-LED, 34 W  
 4.000 lm, 2.300 + 3.000 + 4.000 K



426219107  
 426219131  
 426219132



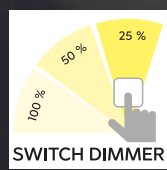

SWITCH DIMMER



# FRANCIS

Metall, Aluminium gebürstet, Weiß matt oder Anthrazit · metal, brushed aluminium, white mat or anthracite ·  
 metale, aluminium balayé, blanc mat ou antracite · metaal, geborsteld aluminium, wit mat of antraciet ·  
 metal, aluminio pulido, estera blanca o antracita · metallo, alluminio spazzolato, bianco opaco o antracite ·  
 metal, aluminiu lucios, alb mat sau antracit · metalli, harjattu alumiini, mattavalkoinen tai antrasiitti ·  
 metal, aluminium szczotkowane, biały mat lub antracyt

-  05 | Aluminium gebürstet · brushed aluminium
-  31 | Weiß matt · white mat
-  42 | Anthrazit · anthracite



Deckenleuchte · Ceiling lamp  
 ↔ 54 x 52 cm, ↑ 19,5 cm  
 incl. SMD-LED, 40 W  
 6.000 lm, 3.000 K



671310105  
 671310131  
 671310142



Pendelleuchte · Pendant  
 ↔ 72 x 68 cm, ↑ 150 cm  
 incl. SMD-LED, 52 W  
 6.500 lm, 3.000 K



371310105  
 371310131  
 371310142



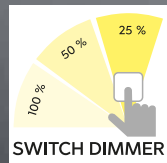
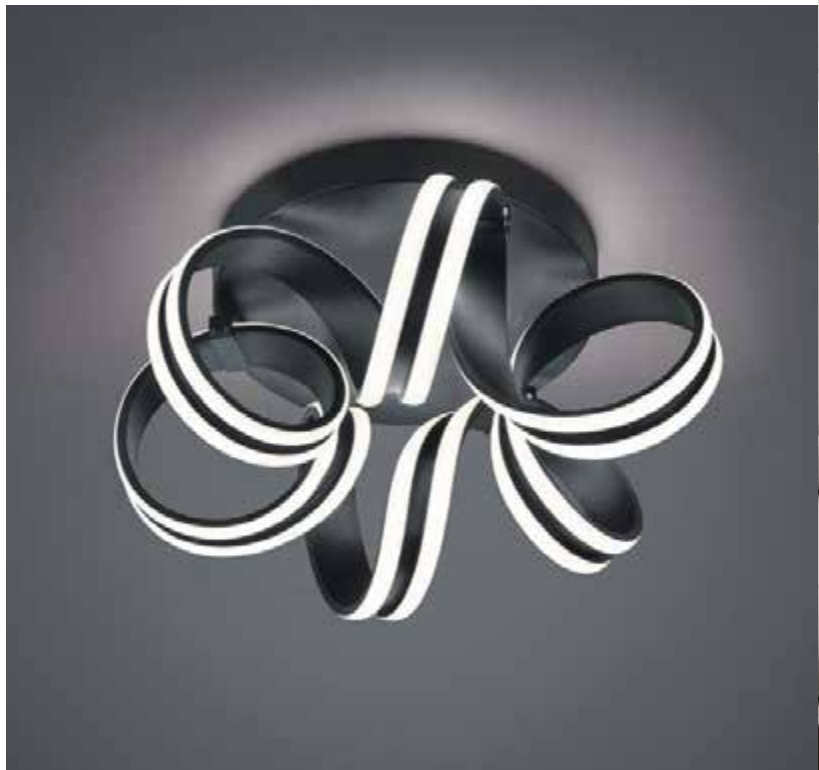
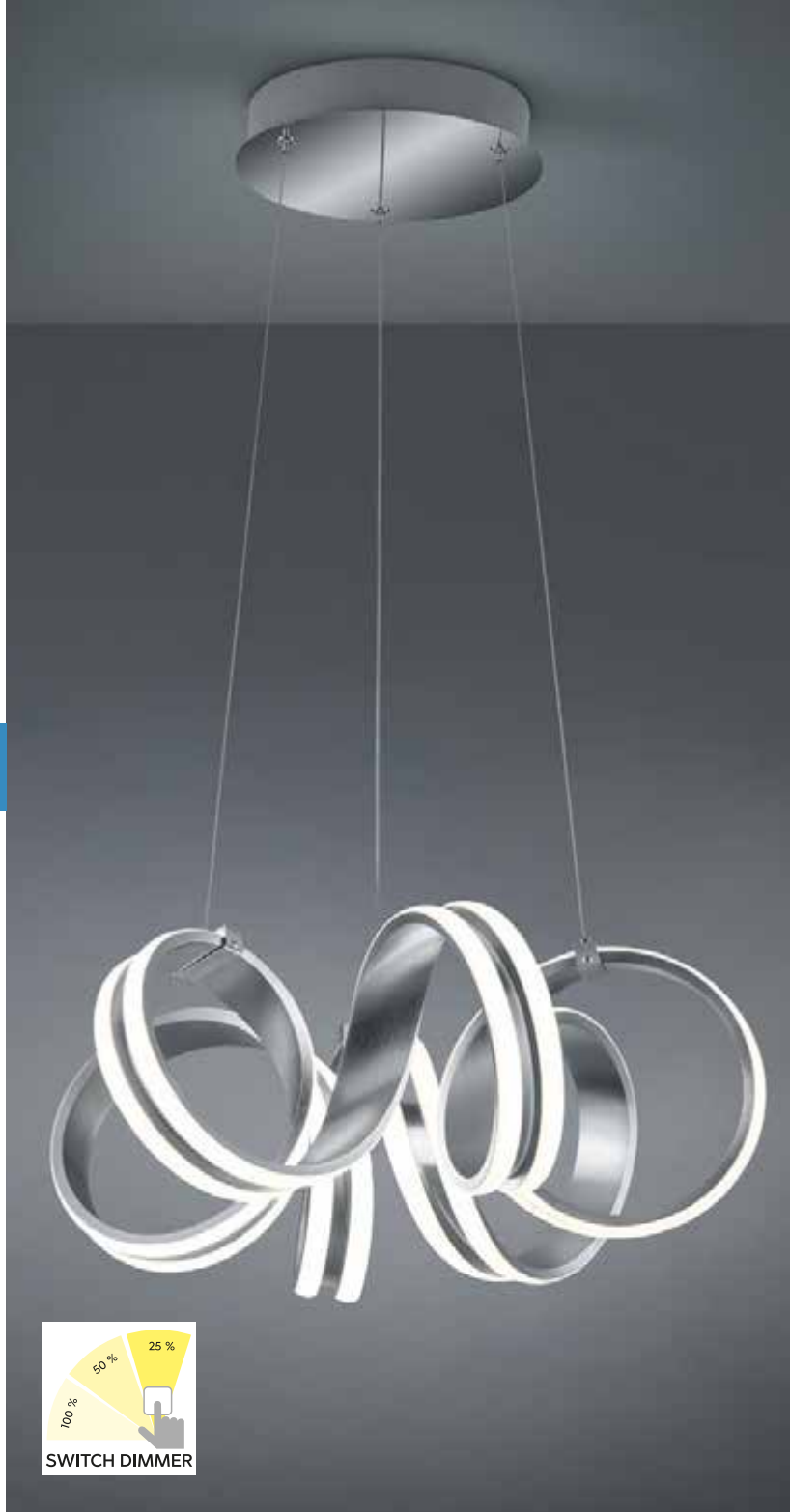

# CARRERA

Metall, Acryl · metal, acryl ·  
 metale, acryl · metaal, acryl · metal, acrilico ·  
 metallo, acrilico · metal, acrilic · metalli, akryyli · metal, akryl

**05** | Aluminium gebürstet · brushed aluminium

**32** | Schwarz matt · black mat



Deckenleuchte · Ceiling lamp  
 Ø 45 cm, ↑ 22 cm  
 incl. SMD-LED, 38 W  
 4.400 lm, 3.000 K



625010105  
 625010132



Pendelleuchte · Pendant  
 ↑ 150 cm, Ø 55 cm  
 incl. SMD-LED, 38 W  
 4.400 lm, 3.000 K



325010105  
 325010132

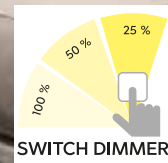

# OAKLAND

Metall, Nickel matt oder Anthrazit · metal, nickel mat or anthracite ·  
 metale, nickel mat ou antracite · metaal, nikkell mat of antraciet ·  
 metal, niquel mate o antracita · metallo, nichel opaco o antracite ·  
 metal, nichel mat sau antracit · metalli, harjattu teräs tai antrasiitti ·  
 metal, nikiel mat lub antracyt

**07** | Nickel matt · nickel mat

**42** | Anthrazit · anthracite



Deckenleuchte · Ceiling lamp  
 Ø 53 cm, ↑ 23,5 cm  
 incl. SMD-LED, 40 W  
 5.200 lm, 3.000 K



621710107  
 621710142



Pendelleuchte · Pendant  
 Ø 71 cm, ↑ 150 cm  
 incl. SMD-LED, 52 W  
 6.200 lm, 3.000 K



321710107  
 321710142





# SYDNEY

Chrom, Acryl · chrome, acryl · chrome, acryl · chroom, acryl · cromo, acrílico · cromo, acrílico · crom, acrílic · kromi, akryyli · chrom, akryl



**Deckenleuchte · Ceiling lamp**  
↔ 103 x 18 cm, ↑ 27 cm  
incl. SMD-LED, 18 W  
2.000 lm, 3.000 K



672910106



**Tischleuchte · Table lamp**  
↑ 63 cm, Ø 20 cm  
incl. SMD-LED, 14,5 W  
1.300 lm, 3.000 K



572910106



**Stehleuchte · Floor lamp**  
↑ 162 cm, Ø 25 cm  
incl. SMD-LED, 22 W  
2.500 lm, 3.000 K



472910106



# SALERNO

Metall, weiß matt, schwarz matt oder goldfarbig/rost · metal, white mat, black mat or gold/rusty · metale, blanc mat, noir mat ou or/rouill · metaal, wit mat, mat zwart of goud/roestkleur · metal, estera blanca, estera negra o oro/óxido · metallo, bianco opaco, nero opaco o oro/ruggine · metal, alb mat, negru mat sau aur/ruginiu · metalli, mattavalkoinen, mattamusta tai kultaa/rustiikki · metal, biały mat, czarny mat lub złota/miedź

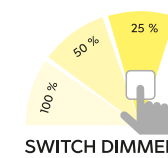

SWITCH DIMMER



31 | Weiß matt · white mat

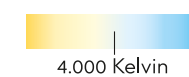

32 | Schwarz matt · black mat

79 | goldfarbig/rost · gold/rusty



**Pendelleuchte · Pendant**  
↔ 115 x 12 cm, ↑ 150 cm  
incl. SMD-LED, 35 W  
4.100 lm, 3.000 K  
(31 = 4.100 lm, 4.000 K)



324610131  
324610132  
324610179



**Stehleuchte · Floor lamp**  
↑ 140 cm, ↔ 22 x 22 cm  
incl. SMD-LED, 31 W  
2.900 lm, 3.000 K



424610132  
424610179





# JIVE

Metall, Acryl · metal, acryl ·  
metale, acryl · metaal, acryl · metal, acrilico ·  
metallo, acrilico · metal, acrilic · metalli, akryyli ·  
metal, akryl

 **07** | Nickel matt · nickel mat

 **31** | Weiß matt · white mat

 **32** | Schwarz matt · black mat



**Deckenleuchte · Ceiling lamp**  
↔ 50 x 45,5 cm, ↑ 7,6 cm cm  
incl. SMD-LED, 36 W  
4.300 lm, 2.700 - 6.000 K



623410207  
623410231  
623410232



**Deckenleuchte · Ceiling lamp**  
↔ 80 x 73 cm, ↑ 7,6 cm  
incl. SMD-LED, 48 W  
5.600 lm, 2.700 - 6.000 K



623419207  
623419231  
623419232



**Stehleuchte · Floor lamp**  
↑ 118 cm, ↔ 32 x 24 cm  
incl. SMD-LED, 23 W  
2.700 lm, 2.700 + 4.000 + 6.000 K



423410107  
423410131  
423410132





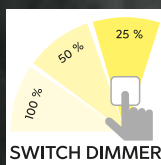
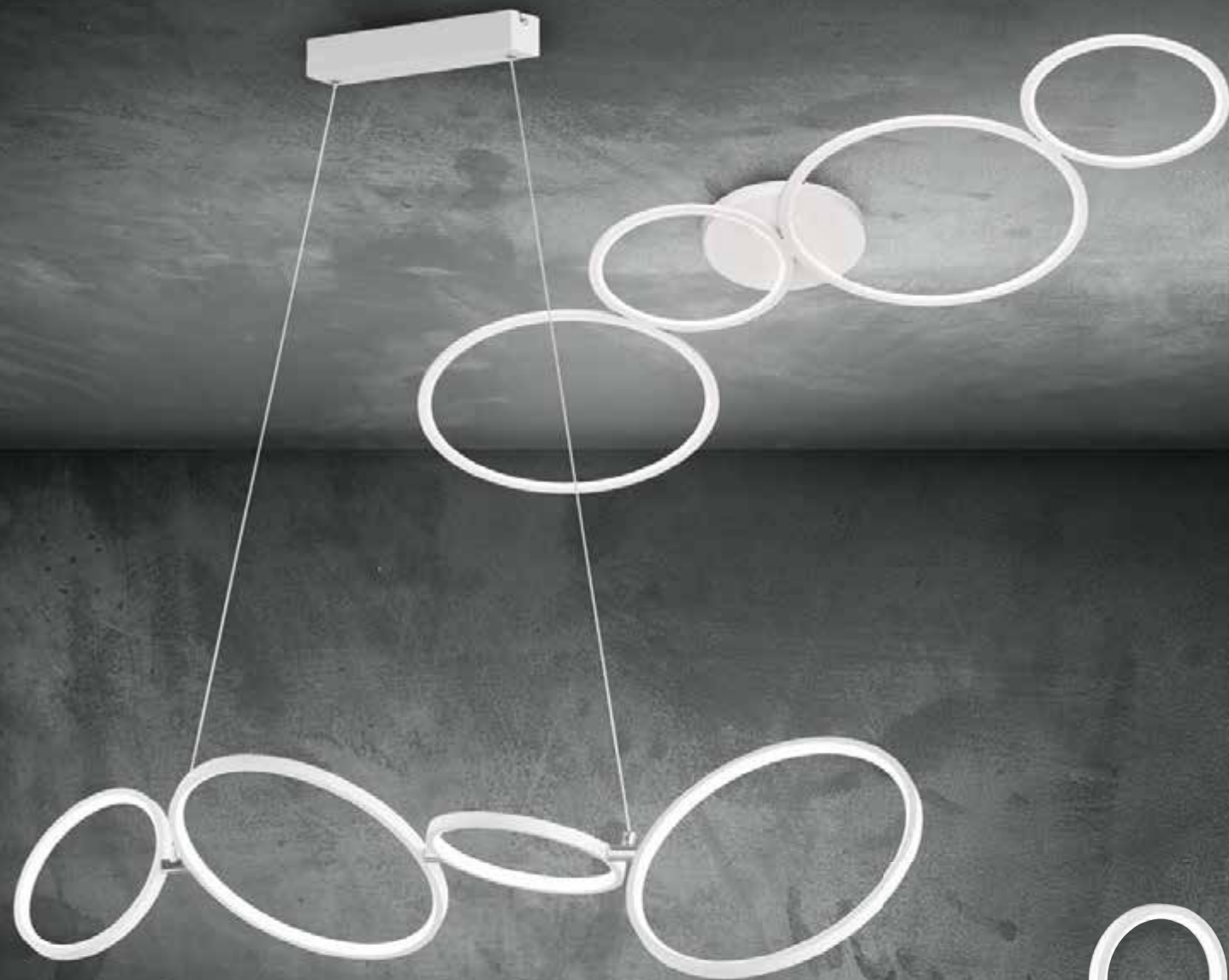

SWITCH DIMMER



Deckenleuchte · Ceiling lamp  
↔ 53 x 59 cm, ↑ 5,5 cm  
incl. SMD-LED, 49 W  
5.800 lm, 3.000 K



622610531  
622610532



Deckenleuchte · Ceiling lamp  
↔ 97 x 34,3 cm, ↑ 5,5 cm  
incl. SMD-LED, 37 W  
4.800 lm, 3.000 K



622610431  
622610432



Pendelleuchte · Pendant  
↔ 110 x 30 cm, ↑ 150 cm  
incl. SMD-LED, 37 W  
4.600 lm, 3.000 K



322610431  
322610432



Tischleuchte · Table lamp  
↑ 45 cm, ↔ 20,7 cm  
incl. SMD-LED, 17 W  
1.900 lm, 3.000 K



522610331  
522610332



## RONDO

Metall, Weiß matt oder Schwarz matt · metal, white mat or black mat ·  
metale, blanc mat ou noir mat · metaal, wit mat of mat zwart ·  
metal, estera blanca o estera negra · metallo, bianco opaco o nero opaco ·  
metal, alb mat sau negru mat · metalli, mattavalkoinen tai mattamusta ·  
metal, biały mat lub czarny mat



31 | Weiß matt · white mat



32 | Schwarz matt · black mat



Stehleuchte · Floor lamp  
↑ 115 cm, ↔ 47 cm  
incl. SMD-LED, 36 W  
4.700 lm, 3.000 K



422610531  
422610532



Pendelleuchte · Pendant  
↑ 150 cm, ↔ 30 cm  
incl. SMD-LED, 22 W  
1.950 lm, 3.000 K



322610232



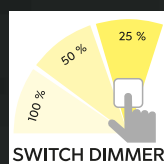

SWITCH DIMMER

## RONDO

Metall, silberfarbig · metal, silver ·  
metale, argente · metaal, zilver · metal, plata · metallo, argenteo ·  
metal, argint · metalli, hopea · metal, srebrny



**Deckenleuchte · Ceiling lamp**  
↔ 59 x 53 cm, ↑ 5,5 cm  
incl. SMD-LED, 49 W  
5.800 lm, 3.000 K



622610589



**Deckenleuchte · Ceiling lamp**  
↔ 97 x 34,3 cm, ↑ 5,5 cm  
incl. SMD-LED, 37 W  
4.800 lm, 3.000 K



622610489



**Pendelleuchte · Pendant**  
↔ 110 x 30 cm, ↑ 150 cm  
incl. SMD-LED, 37 W  
4.600 lm, 3.000 K



322610489



**Tischleuchte · Table lamp**  
↑ 45 cm, ↔ 20,7 cm  
incl. SMD-LED, 17 W  
1.900 lm, 3.000 K



522610389



**Stehleuchte · Floor lamp**  
↑ 115 cm, ↔ 47 cm  
incl. SMD-LED, 36 W  
4.700 lm, 3.000 K



422610589





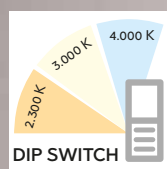



# BLAZE

Metall, Aluminium gebürstet oder Messing matt, Schwarz matt · metal, brushed aluminium or brass mat, black mat · métal, aluminium balayé ou laiton mat, noir mat · metaal, geborsteld aluminium of messing mat, mat zwart · metal, aluminio pulido o bronce mate, estera negra · metallo, alluminio spazzolato o ottone satinato, nero opaco · metal, aluminiu lucios sau bronz mat, negru mat · metalli, harjattu alumiini tai mattamessinki, mattamusta · metal, aluminium szczotkowane lub mosiądz mat, czarny mat

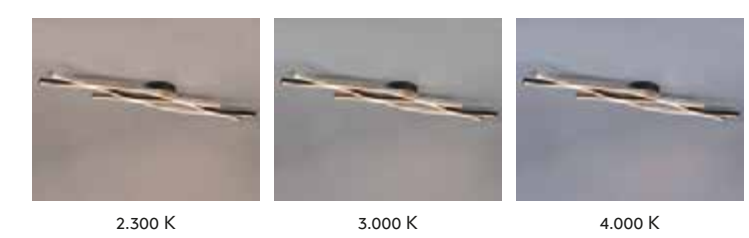
 Lichtfarbe einstellbar · Adjustable light color



  
**Deckenleuchte · Ceiling lamp**  
 ↔ 107,5 x 18 cm, ↓ 7 cm  
 incl. SMD-LED, 35 W  
 4.300 lm, 2.300 + 3.000 + 4.000 K  
   
 641210305  
 641210308

  
**Pendelleuchte · Pendant**  
 ↓ 150 cm, ↔ 107,5 x 15,5 cm  
 incl. SMD-LED, 35 W  
 4.300 lm, 2.300 + 3.000 + 4.000 K  
   
 341210305  
 341210308

  
**Tischleuchte · Table lamp**  
 ↓ 48 cm, ↔ 13,5 cm  
 incl. SMD-LED, 8 W  
 750 lm, 2.300 + 3.000 + 4.000 K  
    
 541210205  
 541210208

  
**Stehleuchte · Floor lamp**  
 ↓ 138 cm, ↔ 20,5 cm  
 incl. SMD-LED, 28 W  
 3.250 lm, 2.300 + 3.000 + 4.000 K  
     
 441210305  
 441210308





**Pendelleuchte · Pendant**  
 ↔ 118,5 x 19,3 cm, ↓ 150 cm  
 incl. SMD-LED, 35 W  
 4.100 lm, 2.300 + 3.000 + 4.000 K



326810131  
 326810132



**Tischleuchte · Table lamp**  
 ↓ 44 cm, ↔ 21 x 17,5 cm  
 incl. SMD-LED, 9 W  
 950 lm, 2.300 + 3.000 + 4.000 K



526810131  
 526810132



**Stehleuchte · Floor lamp**  
 ↓ 124 cm, ↔ 21 x 17,5 cm  
 incl. SMD-LED, 26 W  
 2.950 lm, 2.300 + 3.000 + 4.000 K



426810131  
 426810132

## EDGE

Metall, Weiß matt oder Schwarz matt / Messing matt · metal, white mat or black mat / brass mat ·  
 metal, blanc mat ou noir mat / laiton mat · metaal, wit mat of mat zwart / messing mat ·  
 metal, estera blanca o estera negra / bronce mate · metallo, bianco opaco o nero opaco / ottone satinato ·  
 metal, alb mat sau negru mat / bronz mat · metalli, mattavalkoinen tai mattamusta / mattamessinki ·  
 metal, biały mat lub czarny mat / mosiądz mat

 Lichtfarbe einstellbar ·  
 Adjustable light color

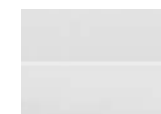

31 | Weiß matt · white mat



32 | Schwarz matt · black mat

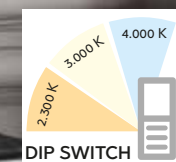



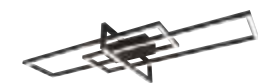
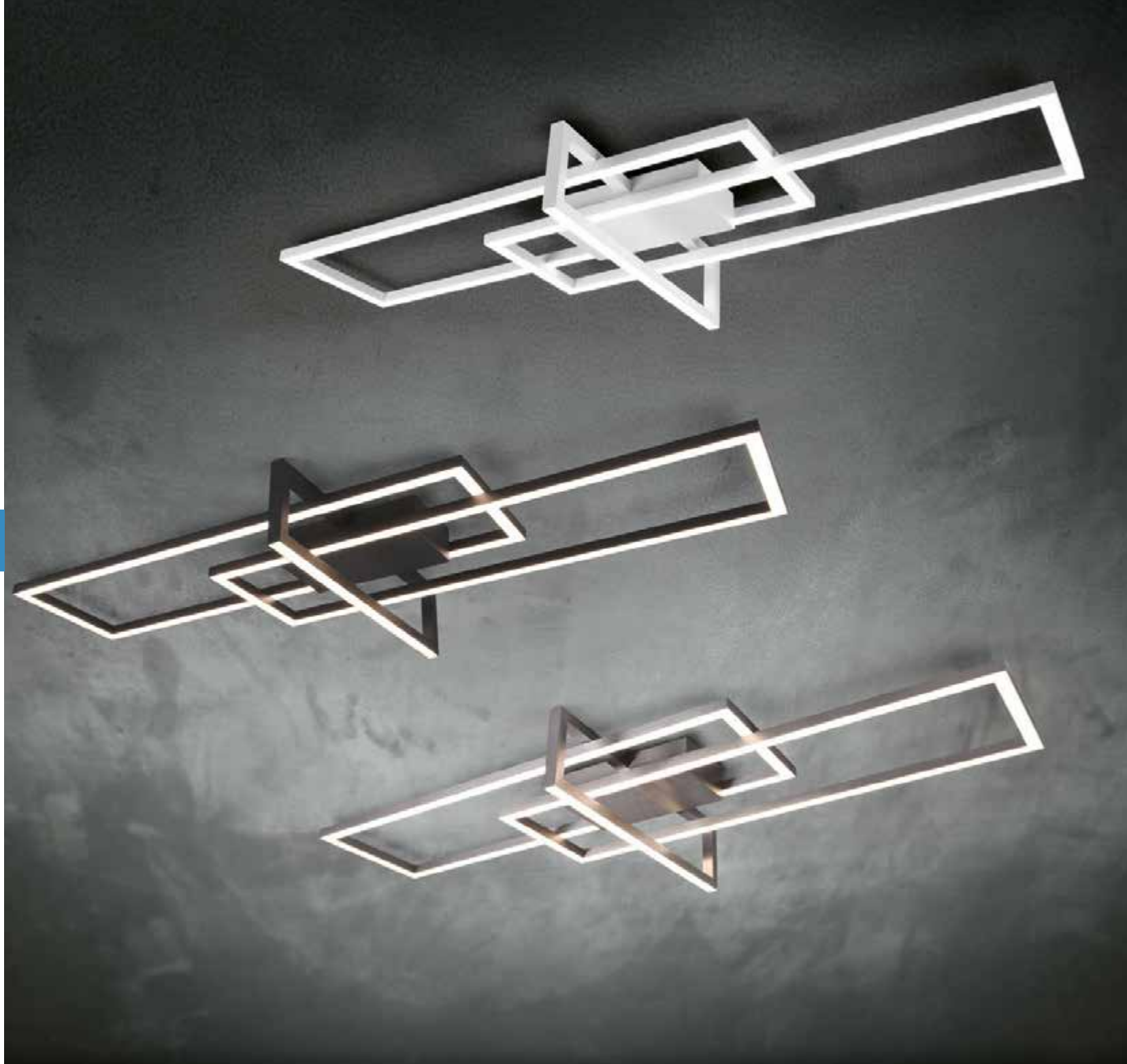

**Deckenleuchte - Ceiling lamp**  
 ↔ 100 x 40 cm, † 11,5 cm  
 incl. SMD-LED, 34 W  
 3.900 lm, 3.000 K  
 (31 = 4.100 lm, 4.000 K)



620310307  
 620310308  
 620310331  
 620310332



**Pendelleuchte - Pendant**  
 † max. 150 cm, ↔ 110 x 40 cm  
 incl. SMD-LED, 34 W  
 4.200 lm, 3.000 K  
 (31 = 4.400 lm, 4.000 K)



320310307  
 320310308  
 320310331  
 320310332

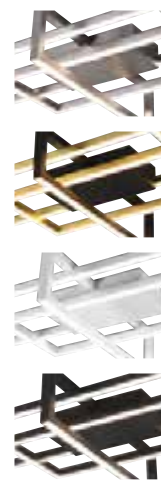

- 07 | Nickel matt · nickel mat
- 08 | Messing matt / Schwarz matt  
brass matt / black mat
- 31 | Weiß matt · white matt
- 32 | Schwarz matt · black matt

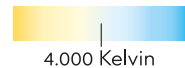

# SALINAS

Metall · metal ·  
 metale · metaal · metal ·  
 metallo · metal · metalli · metal

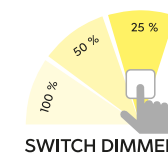

SWITCH DIMMER





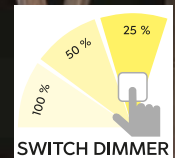
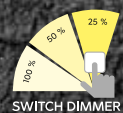
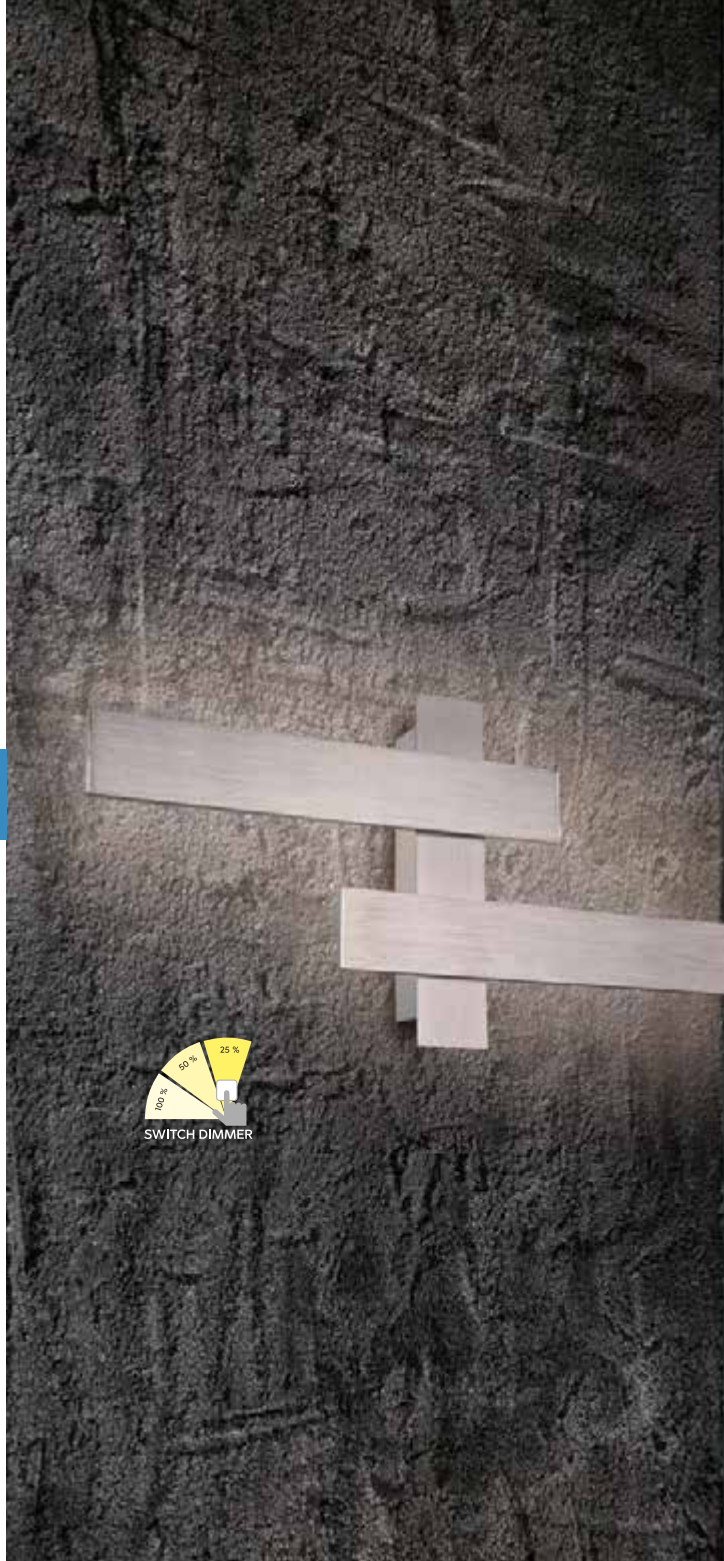

# BELFAST

Metall, Nickel matt oder Schwarz matt · metal, nickel mat or black mat ·  
metale, nickel mat ou noir mat · metaal, nikkel mat of mat zwart ·  
metal, níquel mate o estera negra · metallo, nichel opaco o nero opaco ·  
metal, nichel mat sau negru mat · metalli, harjattu teräs tai mattamusta ·  
metal, nikiel mat lub czarny mat

 indirekte Beleuchtung · indirect lighting

 07 | Nickel matt · nickel mat

 32 | Schwarz matt · black mat



**Wandleuchte · Wall lamp**  
↔ 60 x 30 cm, ↑ 7  
incl. 2 x SMD-LED, 10,5 W  
2 x 1.050 lm, 3.000 K



275510207  
275510232

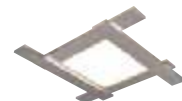

**Deckenleuchte · Ceiling lamp**  
↔ 59 x 59 cm, ↑ 6,5 cm  
incl. SMD-LED, 18 W  
1.700 lm, 3.000 K  
incl. 4 x SMD-LED, 3,5 W  
4 x 350 lm, 3.000 K



675510507  
675510532



Gibt Licht nach oben und unten · up and down lighting ·  
point lumineux en haut et en bas · lichtpunt boven en onder · luz de arriba y abajo ·  
luce su e giù · sus și în jos lumina · ylös ja alas valoa · w górę iw dół światło



**Pendelleuchte · Pendant**  
↔ 115,5 x 14,2 cm, ↑ 150 cm  
incl. SMD-LED, 44 W  
4.400 lm, 3.000 K



375510407  
375510432





Deckenleuchte · Ceiling lamp  
 ↔ 52,5 x 52,5 cm, ↑ 16 cm  
 incl. SMD-LED, 24 W  
 2.800 lm, 3.000 K



627710405  
 627710432



Deckenleuchte · Ceiling lamp  
 ↔ 120,5 x 48,5 cm, ↑ 6 cm  
 incl. SMD-LED, 34 W  
 4.500 lm, 3.000 K



627710505  
 627710532

# SORRENTO

Metall · metal ·  
 metale · metaal · metal · metallo · metal · metalli · metal

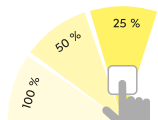

SWITCH DIMMER



05 | Aluminium gebürstet ·  
 brushed aluminium

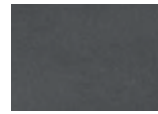

32 | Schwarz matt ·  
 black mat



Stehleuchte · Floor lamp  
 ↑ 125 x 12,5 cm, ↔ 48 cm  
 incl. SMD-LED, 34 W  
 4.500 lm, 3.000 K



427710505  
 427710532



Tischleuchte · Table lamp  
 ↑ 50 x 13 cm, ↔ 24 cm  
 incl. SMD-LED, 15 W  
 1.500 lm, 3.000 K



527710305  
 527710332

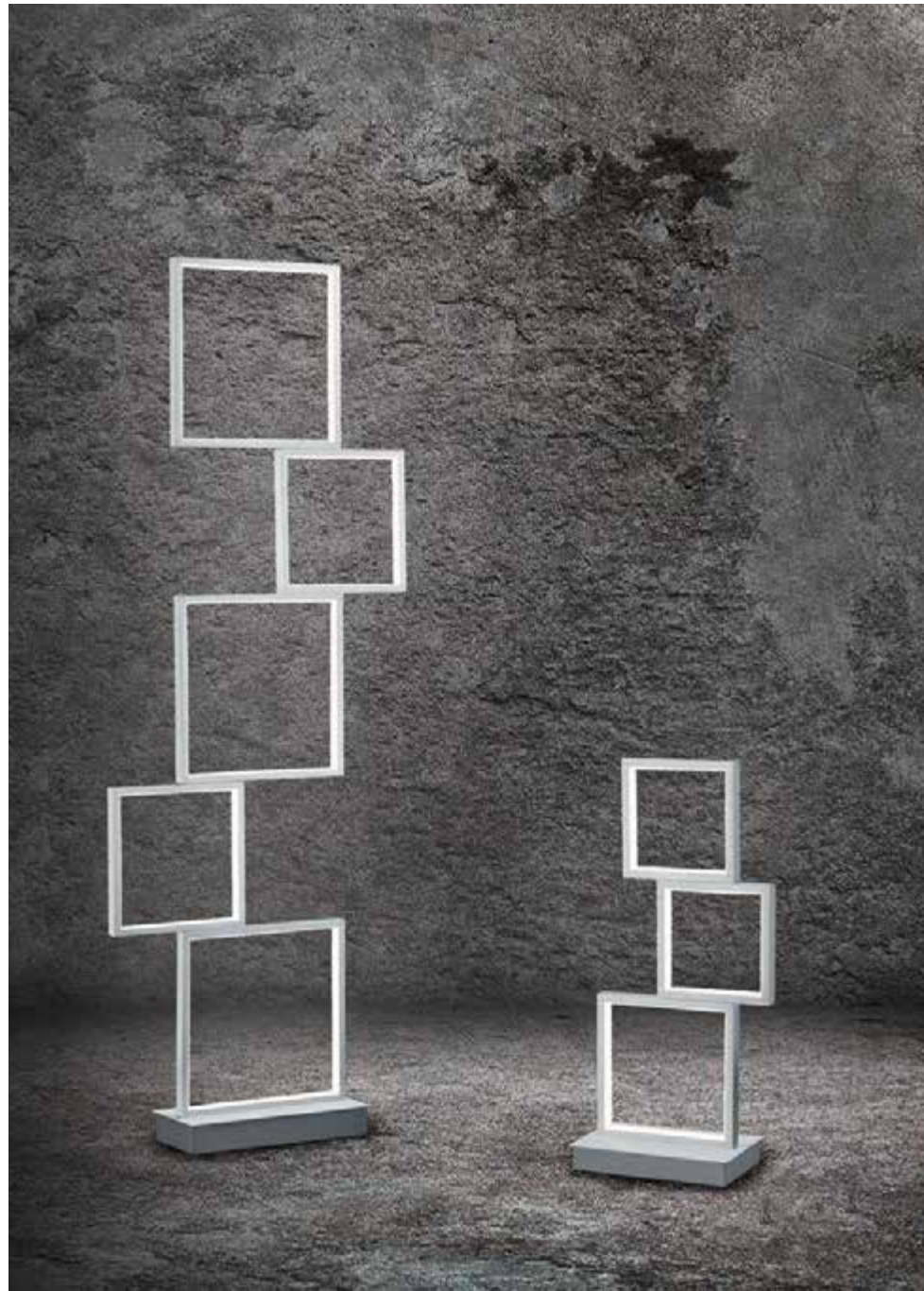



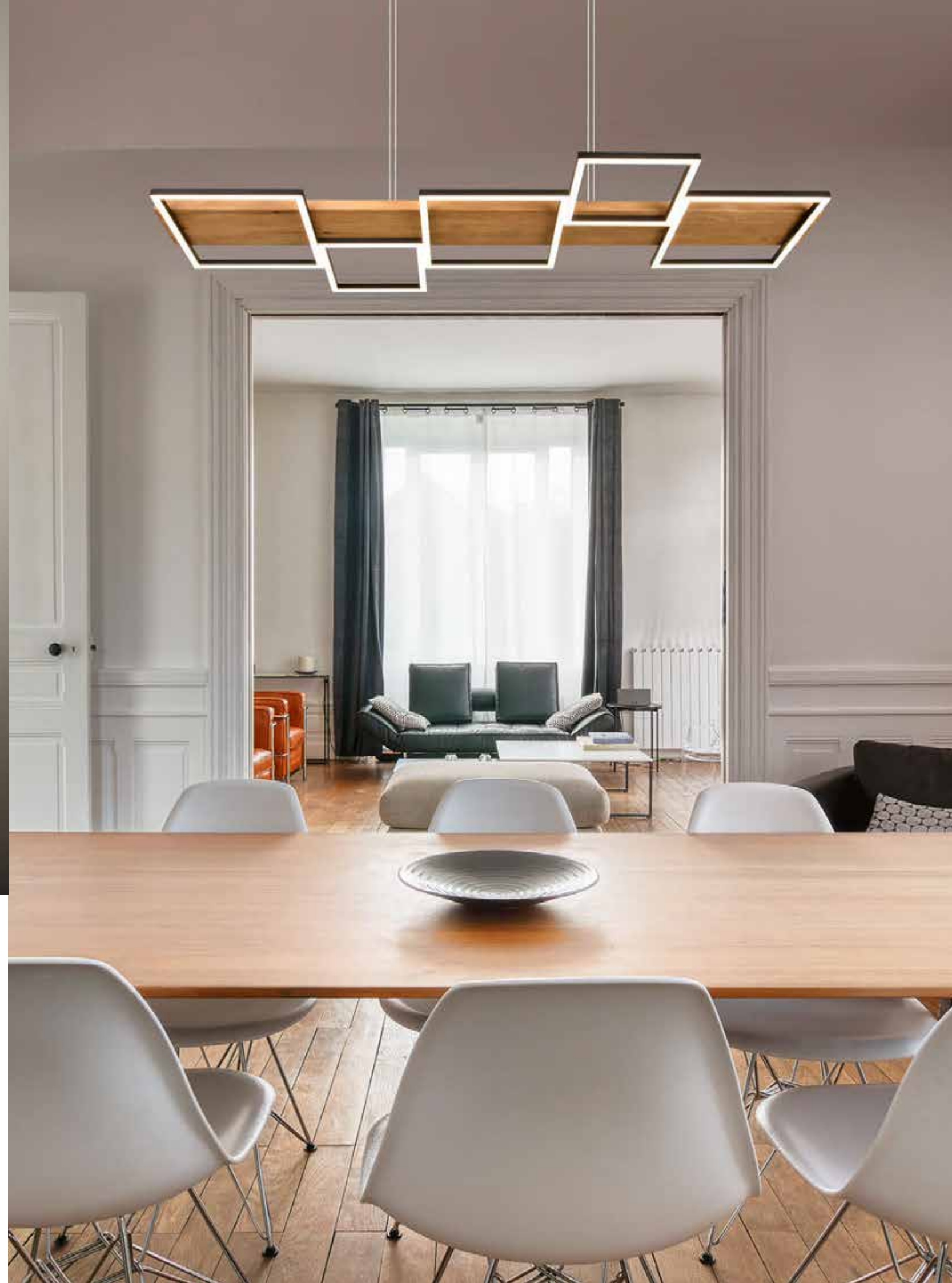

## HARPER

Metall, Schwarz matt, Holz naturbelassen · metal, black mat, wood natural finish ·  
 métal, noir mat, bois finition naturelle · metaal, mat zwart, hout natuurlijke afwerking ·  
 metal, estera negra, maderacabado natural · metallo, nero opaco, di legno finitura naturale ·  
 metal, negru mat, lemn finisaj natural · metalli, mattamusta, puu luonnollinen viimeistely ·  
 metal, czarny mat, drewno naturalne wykończenie

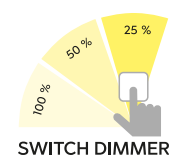

SWITCH DIMMER



Deckenleuchte · Ceiling lamp  
 ↔ 65 x 34,5 cm, ↓ 7,5 cm  
 incl. SMD-LED, 30 W  
 4.000 lm, 3.000 K



622910332



Deckenleuchte · Ceiling lamp  
 ↔ 115 x 44,5 cm, ↓ 7,5 cm  
 incl. SMD-LED, 42 W  
 5.700 lm, 3.000 K



622910532



Pendelleuchte · Pendant  
 ↓ 150 cm, ↔ 115 x 44,5 cm  
 incl. SMD-LED, 42 W  
 5.700 lm, 3.000 K



322910532



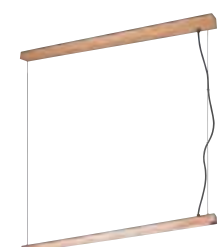
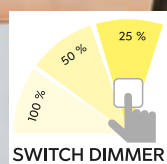

**Pendelleuchte · Pendant**  
 ↔ 115 x 6,5 cm, ↓ 150 cm  
 incl. SMD-LED, 27,5 W  
 3.150 lm, 3.000 K



326410130



**Stehleuchte · Floor lamp**  
 ↓ 115 cm, ↔ 22 x 22 cm  
 incl. SMD-LED, 20 W  
 2.300 lm, 3.000 K



426410130



4 fach TOUCH ·  
 4 level Touch function



# BELLARI

Holz, Metall Schwarz matt · wood, metal black mat ·  
 bois, metale noir mat · hout, metaal mat zwart · madera, metal estera negra ·  
 di legno, metallo nero opaco · lemn, metal negru mat · puu, metalli mattamusta ·  
 drewno, metal czarny mat

 Lichtfarbe stufenlos einstellbar ·  
 Light color infinitely variable

 Integrierter Dimmer ·  
 Integrated dimmer



2.700 K

6.000 K



**Deckenleuchte · Ceiling lamp**  
 ↔ 180 x 10 cm, ↓ 13,5 cm  
 incl. SMD-LED, 36 W  
 4.200 lm, 2.700 - 6.000 K



626410530





# KERALA

Metall, Schwarz matt, Holz naturbelassen · metal, black mat, wood natural finish ·  
 métal, noir mat, bois finition naturelle · metaal, mat zwart, hout natuurlijke afwerking ·  
 metal, estera negra, madera acabado natural · metallo, nero opaco, di legno finitura naturale ·  
 metal, negru mat, lemn finisaj natural · metalli, mattamusta, puu luonnollinen viimeistely ·  
 metal, czarny mat, drewno naturalne wykończenie

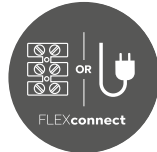

Seite/page 632



**Wandleuchte · Wall lamp**  
 ↓ 7 cm, ↔ 30 cm, ↗ 13 cm  
 incl. SMD-LED, 9 W  
 1.100 lm, 3.000 K



241670132



**Deckenleuchte · Ceiling lamp**  
 ↔ 83 x 14,5 cm, ↓ 11,5 cm  
 incl. 2 x SMD-LED, 12,5 W  
 2 x 1.500 lm, 3.000 K



641610232



**Pendelleuchte · Pendant**  
 ↓ 150 cm, ↔ 90 x 8,5 cm  
 incl. SMD-LED, 25 W  
 3.000 lm, 3.000 K



341610132



**Tischleuchte · Table lamp**  
 ↓ 50 cm, ↔ 11 x 14 cm  
 incl. SMD-LED, 8 W  
 950 lm, 3.000 K



541610132



**Stehleuchte · Floor lamp**  
 ↓ 120 cm, ↔ 19 x 13 cm  
 incl. SMD-LED, 16 W  
 1.950 lm, 3.000 K



441610132





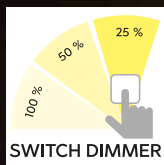

# DEACON



Metall, Nickel matt oder Schwarz matt, Holz · metal, nickel mat or black mat, wood ·  
 metale, nickel mat ou noir mat, bois · metaal, nikkel mat of mat zwart, hout · metal, níquel mate o estera negra, madera ·  
 metallo, nichel opaco o nero opaco, di legno · metal, nichel mat sau negru mat, lemn · metalli, harjattu teräs tai mattamusta, puu ·  
 metal, nikiel mat lub czarny mat, drewno



Deckenleuchte · Ceiling lamp  
 Ø 50 cm, ↑ 7 cm  
 incl. SMD-LED, 37 W  
 4.400 lm, 3.000 K



626610207  
 626610232

-  **07** | Nickel matt, Holz ·  
nickel mat, wood
-  **32** | Schwarz matt, Holz ·  
black mat, wood



 Lichtfarbe stufenlos einstellbar ·  
Light color infinitely variable

 Sensordimmer ·  
Sensor dimmer

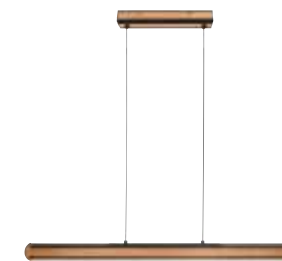

Pendelleuchte · Pendant  
 ↔ 110 x 6,5 cm, ↑ 150 cm  
 incl. SMD-LED, 42 W  
 3.200 lm, 2.700 - 6.000 K



326610207  
 326610232





# CAMDEN

Nickel matt, Stoffschirm · nickel mat, fabric shade ·  
 nickel mat, abat-jour tissu · nikkell mat, Stoffen kap · níquel mate, Pantalla de tela ·  
 nichel opaco, paralume in tessuto · nichel mat, abajur textil · harjattu teräs, kangas varjostin ·  
 nikiel mat, Klosz z materiału



Deckenleuchte · Ceiling lamp  
 Ø 50 cm, ↑ 35 cm  
 excl. 3 x E27, max. 40 W



608300307

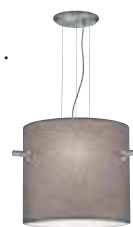

Pendelleuchte · Pendant  
 Ø 50 cm, ↑ 150 cm  
 excl. 3 x E27, max. 40 W



308300307



Stehleuchte · Floor lamp  
 ↑ 145 - 180 cm, Ø 50 cm  
 excl. 3 x E27, max. 40 W



408300307



Höhenverstellbar ·  
 Adjustable height



Getrennt schaltbar ·  
 Separately switchable







## CAMDEN

Messing matt, Stoffschirm · brass mat, fabric shade ·  
 laiton mat, abat-jour tissu · messing mat, Stoffen kap ·  
 bronze mate, Pantalla de tela · ottone satinato, paralume  
 in tessuto · bronz mat, abajur textil · mattamessinki,  
 kangas varjostin · mosiądz mat, Klosz z materiału



Pendelleuchte · Pendant  
 Ø 50 cm, ↑ 150 cm  
 excl. 3 x E27, max. 40 W



308300308



Deckenleuchte · Ceiling lamp  
 Ø 50 cm, ↑ 35 cm  
 excl. 3 x E27, max. 40 W



608300308



Stehleuchte · Floor lamp  
 ↑ 145 - 180 cm, Ø 50 cm  
 excl. 3 x E27, max. 40 W



408300308





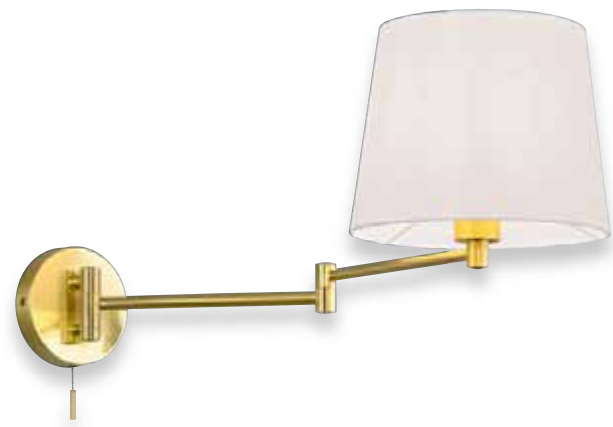

Wandleuchte · Wall lamp  
 † 32,5 x 25,5 cm, † 69 cm  
 excl. 1 x E27, max. 60 W

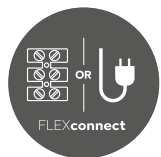

209100107  
 209100108

Seite/page 632



07 | Nickel matt · nickel mat



08 | Messing matt · brass mat

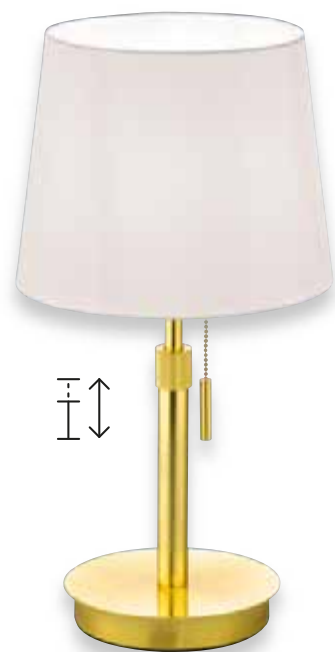

Tischleuchte · Table lamp  
 † 45 - 56 cm, Ø 25,5 cm  
 excl. 1 x E27, max. 60 W



509100107  
 509100108



## LYON

Nickel matt oder Messing matt, Stoffschirm · nickel mat or brass mat, fabric shade ·  
 nickel mat ou laiton mat, abat-jour tissu · nikel mat of messing mat, Stoffen kap ·  
 níquel mate o bronze mate, Pantalla de tela · nichel opaco o ottone satinato, paralume in tessuto ·  
 nichel mat sau bronz mat, abajur textil · harjattu teräs tai mattamessinki, kangas varjostin ·  
 nikiel mat lub mosiądz mat, Klosz z materiału



Getrennt schaltbar · Separately switchable ·  
 Interrupteurs séparés · Gescheiden schakelbaar ·  
 Interruptores separados · Interruttori separati ·  
 Intreruptoare separate · Erikseen kytkettävissä ·  
 Oddzielny przełącznik



Stehleuchte · Floor lamp  
 † 138 - 180 cm, Ø 46,3 cm  
 excl. 3 x E27, max. 60 W



409100307  
 409100308





## BURTON

Metall, Schwarz matt, Stoffschirm · metal, black mat, fabric shade ·  
 métal, noir mat, abat-jour tissu · metaal, mat zwart, stoffen kap · metal, estera negra, pantalla de tela ·  
 metallo, nero opaco, paralume in tessuto · metal, negru mat, abajur textil · metalli, mattamusta, kangas varjostin ·  
 metal, czarny mat, klosz z materiału



Pendelleuchte · Pendant  
 ↑ 150 cm, Ø 45 cm  
 excl. 1 x E27, max. 40 W



311400132

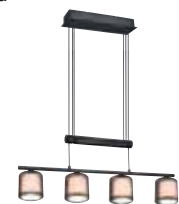

Pendelleuchte · Pendant  
 ↑ 95 - 150 cm, ↔ 82,5 x 12,5 cm  
 excl. 4 x E14, max. 40 W



311400432



Tischleuchte · Table lamp  
 ↑ 28,5 cm, Ø 12,5 cm  
 excl. 1 x E14, max. 40 W



511400132



Stehleuchte · Floor lamp  
 ↑ 171 cm, ∟ 114 cm  
 excl. 1 x E27, max. 40 W



411490132







## BURTON

Metall, Schwarz matt, Stoffschirm · metal, black mat, fabric shade ·  
 métal, noir mat, abat-jour tissu · metaal, mat zwart, stoffen kap · metal, estera negra, pantalla de tela ·  
 metallo, nero opaco, paralume in tessuto · metal, negru mat, abajur textil · metalli, mattamusta, kangas varjostin ·  
 metal, czarny mat, klosz z materiału



Deckenleuchte · Ceiling lamp  
 ↔ 65 x 55 cm, ↑ 21,5 cm  
 excl. 3 x E27, max. 40 W



611490332

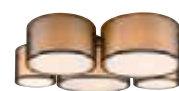

Deckenleuchte · Ceiling lamp  
 ↔ 90 x 70 cm, ↑ 21,5 cm  
 excl. 5 x E27, max. 40 W



611400532



Stehleuchte · Floor lamp  
 ↓ 150 cm, Ø 35 cm  
 excl. 1 x E27, max. 40 W



411400132



Stehleuchte · Floor lamp  
 ↓ 174 cm, Ø 45 cm  
 excl. 1 x E27, max. 60 W  
 excl. 1 x E14, max. 40 W



411400232







Seite/page 632

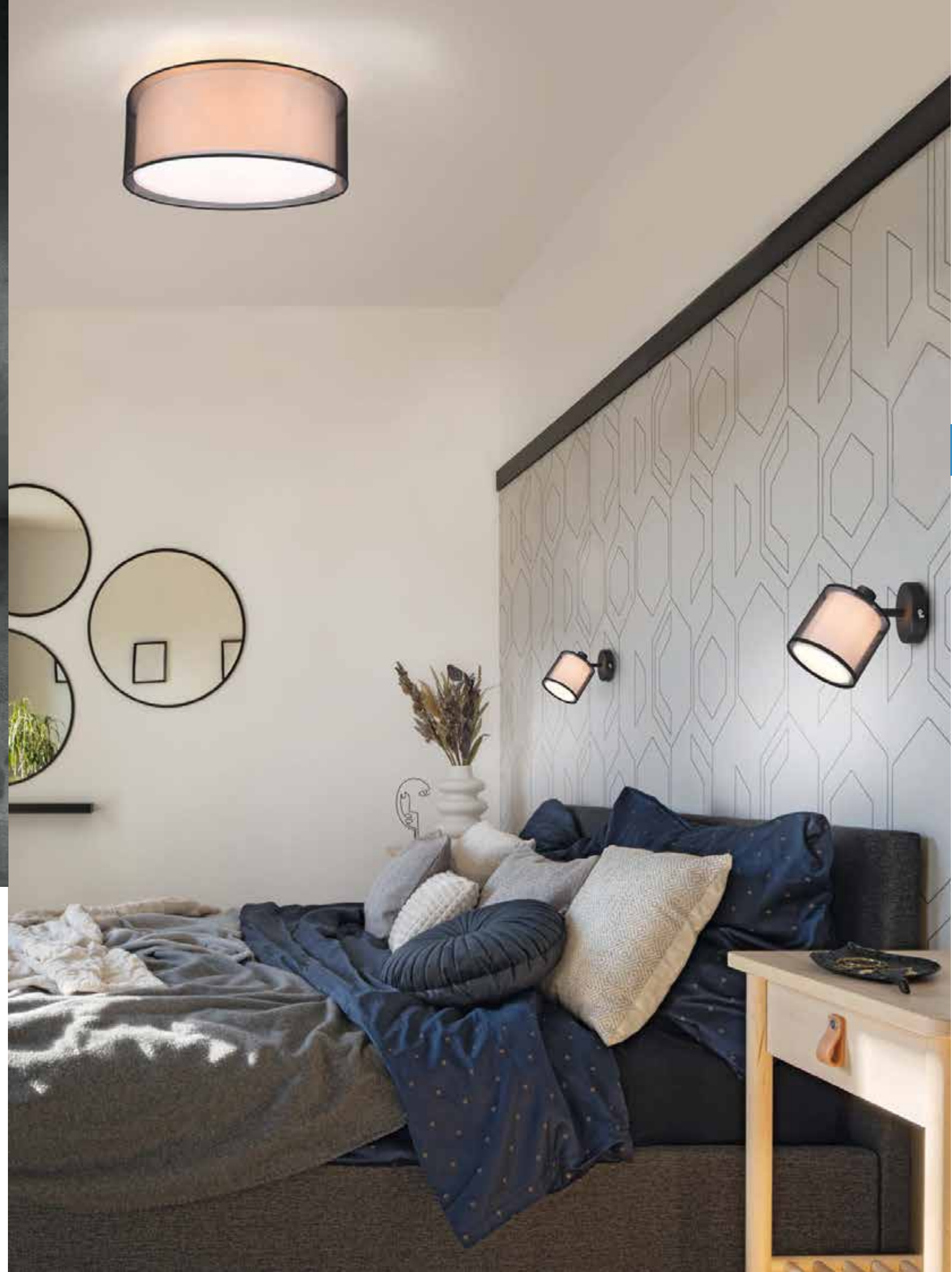

## BURTON

Metall, Schwarz matt, Stoffschirm · metal, black mat, fabric shade ·  
 métal, noir mat, abat-jour tissu · metaal, mat zwart, stoffen kap · metal, estera negra, pantalla de tela ·  
 metallo, nero opaco, paralume in tessuto · metal, negru mat, abajur textil · metalli, mattamusta, kangas varjostin ·  
 metal, czarny mat, klosz z materiału



Strahler · Spot  
 ↓ 19,5 cm, ↔ 10 cm, √ 18,5 cm  
 excl. 1 x E14, max. 28 W



811400132



Strahler · Spot  
 ↔ 32,5 x 18 cm, ↓ 19,5 cm  
 excl. 2 x E14, max. 28 W



811400232



Strahler · Spot  
 ↔ 71,5 x 18 cm, ↓ 19,5 cm  
 excl. 4 x E14, max. 28 W



811400432



Strahler · Spot  
 Ø 49 cm, ↓ 22 cm  
 excl. 3 x E14, max. 28 W



811430332



Deckenleuchte · Ceiling lamp  
 Ø 50 cm, ↓ 25 cm  
 excl. 3 x E27, max. 40 W



611400332





Deckenleuchte · Ceiling lamp  
 ↔ 75 x 44,2 cm, ↓ 22 cm  
 excl. 5 x E14, max. 25 W



- 605400501
- 605400511
- 605400541
- 605400579
- 605400589



Tischleuchte · Table lamp  
 ↓ 18 cm, Ø 9,5 cm  
 excl. 1 x E14, max. 25 W



- 595400101
- 595400111
- 595400141
- 595400179
- 595400189



# GARDA

Nickel matt, Stoffschirm · nickel mat, fabric shade ·  
 nickel mat, abat-jour tissu · nikkell mat, Stoffen kap · níquel mate, Pantalla de tela ·  
 nichel opaco, paralume in tessuto · nichel mat, abajur textil · harjattu teräs, kangas varjostin ·  
 nikiel mat, Klosz z materiału

- |   |   |
|---|---|
|  <b>01</b>   Weiß · white  |  <b>79</b>   goldfarbig · gold     |
|  <b>11</b>   Grau · grey   |  <b>89</b>   silberfarbig · silver |
|  <b>41</b>   Taupe · taupe |   |



Pendelleuchte · Pendant  
 ↔ 77 x 13,5 cm, ↓ 95 - 150 cm  
 excl. 4 x E14, max. 28 W



- 305400401
- 305400411
- 305400441
- 305400479
- 305400489





# HOSTEL

Metall, Stoffschirm innen goldfarbig · metal, fabric shade gold colored inside ·  
 metale, abat-jour tissu Or · metaal, Stoffen kap Binnenkant goudkleur ·  
 metal, Pantalla de tela Interior en color dorado · metallo, paralume in tessuto  
 interno colore oro · metal, abajur textil interior culoare aurie · metalli, kangas  
 varjostin sisäosa kullanvärinen · metal, Klosz z materiału wewnątrz złoty



Deckenleuchte · Ceiling lamp  
 Ø 30 cm, ↑ 22 cm  
 excl. 2 x E14, max. 40 W



608200279



Tischleuchte · Table lamp  
 ↑ 33 cm, Ø 20 cm  
 excl. 1 x E27, max. 40 W



508200179



Stehleuchte · Floor lamp  
 ↑ 160,5 cm, Ø 35 cm  
 excl. 1 x E27, max. 60 W



408200179



Pendelleuchte · Pendant  
 Ø 40 cm, ↑ 150 cm  
 excl. 1 x E27, max. 60 W



308200179



Stehleuchte · Floor lamp  
 ↑ max. 156 cm, Ø 35 cm, √ max. 63 cm  
 excl. 1 x E27, max. 60 W



408290179





## IBIS

Stoffschild, Nickel matt · fabric shade, nickel mat ·  
 abat-jour tissu, nickel mat · Stoffen kap, nikkel mat ·  
 Pantalla de tela, níquel mate · paralume in tessuto, nichel opaco ·  
 abajur textil, nichel mat · kangas varjostin, harjattu teräs ·  
 Klosz z materiału, nikiel mat



Deckenleuchte · Ceiling lamp  
 Ø 45 cm, ↑ 39,6 cm  
 excl. 3 x E27, max. 40 W



609400317



Pendelleuchte · Pendant  
 ↑ 150 cm, Ø 45 cm  
 excl. 3 x E27, max. 40 W



309400317







# HOTEL

Stoffschirm, mehrfarbig · fabric shade, multicolor · abat-jour tissu, multicolore · Stoffen kap, multicolor · Pantalla de tela, multicolor · paralume in tessuto, multicolore · abajur textil, multicolor · kangas varjostin, monivärinen · Klosz z materiału, multi-kolor

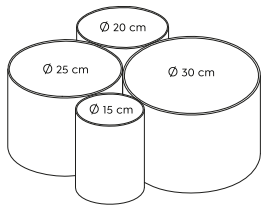

Deckenleuchte · Ceiling lamp  
↔ 50,5 x 47 cm, ↓ 21,5 cm  
excl. 4 x E27, max. 42 W



693900417

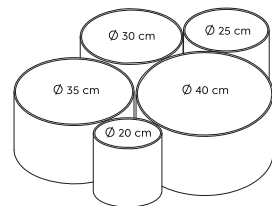

Deckenleuchte · Ceiling lamp  
↔ 90 x 70 cm, ↓ 21,5 cm  
excl. 5 x E27, max. 42 W



693900517

Empfohlen:  
recommended: LED E27, 5 W  
400 lm, 3.000 K



986-60

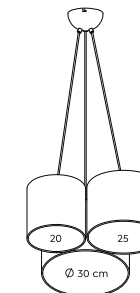

Pendelleuchte · Pendant  
↔ 45,4 x 52,5 cm, ↓ 150 cm  
excl. 3 x E27, max. 42 W



393900317

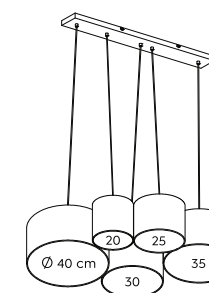

Pendelleuchte · Pendant  
↔ 96,5 x 68,5 cm, ↓ 150 cm  
excl. 5 x E27, max. 42 W



393900517





-  **01** | Weiß · white
-  **02** | Schwarz · black
-  **11** | Grau · grey



Deckenleuchte · Ceiling lamp  
 Ø 30 cm, ↑ 16 cm  
 excl. 2 x E14, max. 40 W



603900201  
 603900202  
 603900211



Deckenleuchte · Ceiling lamp  
 Ø 50 cm, ↑ 17 cm  
 excl. 3 x E27, max. 60 W



603900301  
 603900302  
 603900311



Deckenleuchte · Ceiling lamp  
 Ø 65 cm, ↑ 17 cm  
 excl. 5 x E27, max. 60 W



603900501  
 603900502  
 603900511

# HOTEL

Nickel matt, Stoff · nickel mat, fabric ·  
 nickel mat, tissu · nikkell mat, textiel · níquel mate, tela ·  
 nichel opaco, tessuto · nichel mat, textil · harjattu teräs, tekstiili · nikiel mat, tkanina

-  **01** | Weiß · white
-  **02** | Schwarz · black
-  **11** | Grau · grey

Empfohlen:  
 recommended: LED E27, 10 W  
 806 lm, 3.000 K



 **988-10**



Pendelleuchte · Pendant  
 Ø 40 cm, ↑ 150 cm  
 excl. 1 x E27, max. 60 W



303300101  
 303300102  
 303300111





Stehleuchte · Floor lamp

↑ 160 cm, Ø 35 cm  
excl. 1 x E27, max. 60 W



401100101  
401100102  
401100111

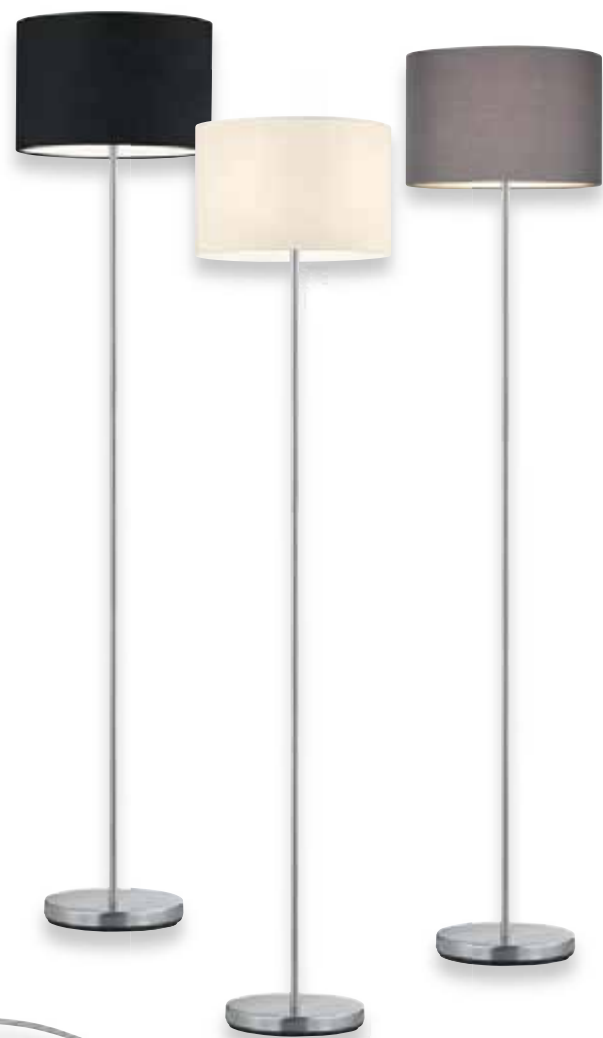

01 | Weiß · white



02 | Schwarz · black



11 | Grau · grey



Stehleuchte · Floor lamp

↑ 150 - 215 cm, Ø 30 cm, ∠ 107 cm  
excl. 1 x E27, max. 60 W



461100101  
461100102  
461100111



01 | Nickel matt, Schirm Weiß · nickel mat, shade white



08 | Messing matt, Schirm Creme-Weiß · brass mat, shade cream white



11 | Nickel matt, Schirm Grau · nickel mat, shade grey



Stehleuchte · Floor lamp

↑ 170 cm, Ø 40 cm, ∠ 35 cm  
excl. 1 x E27, max. 60 W  
excl. 1 x E14, max. 18 W



403900201  
403900208  
403900211

Metall, Stoffschirm · metal, fabric shade ·  
metale, abat-jour tissu · metaal, Stoffen kap ·  
metal, Pantalla de tela · metallo, paralume in tessuto ·  
metal, abajur textil · metalli, kangas varjostin ·  
metal, Klosz z materiału





**Wandleuchte · Wall lamp**  
 † 23,5 x 20 cm, † max. 34,5 cm  
 incl. 1 x COB-LED, 3,1 W  
 310 lm, 3.000 K  
 excl. 1 x E14, max. 40 W



271170201  
 271170202  
 271170211



01



02



Seite/page 632

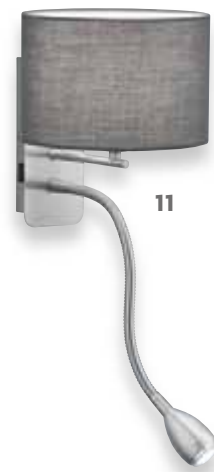

11

# HOTEL

Nickel matt, Stoff · nickel mat, fabric ·  
 nickel mat, tissu · nikkell mat, textiel · níquel mate, tela ·  
 nichel opaco, tessuto · nichel mat, textil · harjattu teräs, tekstiili ·  
 nikiel mat, tkanina

-  01 | Weiß · white
-  02 | Schwarz · black
-  11 | Grau · grey



**Tischleuchte · Table lamp**  
 † 32 cm, Ø 20 cm  
 excl. 1 x E14, max. 40 W



501100101  
 501100102  
 501100111



**Tischleuchte · Table lamp**  
 † 55 cm, Ø 30 cm  
 excl. 1 x E27, max. 60 W



511100101  
 511100102  
 511100111





## BARONESS

Metall, Weiß matt oder Anthrazit, Acryl weiß · metal, white mat or anthracite, acryl white ·  
 metale, blanc mat ou antracite, acryl blanc · metaal, wit mat of antraciet, acryl wit ·  
 metal, estera blanca o antracita, acrílico blanco · metallo,  
 bianco opaco o antracite, acrilico bianco · metal, alb mat  
 sau antracit, acrilic alb · metalli, mattavalkoinen tai  
 antrasiitti, akryyli valkoinen · metal, biały mat lub antracyt,  
 akryl biały



**Pendelleuchte · Pendant**  
 ↓ 150 cm, Ø 45 cm  
 excl. 3 x E27, max. 15 W



308900331  
 308900342



**Pendelleuchte · Pendant**  
 ↔ 105 cm, ↓ 150 cm, Ø 25 cm  
 excl. 6 x E14, max. 15 W



308900631  
 308900642



**Deckenleuchte · Ceiling lamp**  
 Ø 45 cm, ↓ 23 cm  
 excl. 3 x E27, max. 15 W



608900331  
 608900342



31 | Weiß matt · white mat



42 | Anthrazit · anthracite







## BARON

Metall, Weiß matt oder Schwarz matt, Acryl · metal, white mat or black mat, acryl ·  
 metale, blanc mat ou noir mat, acryl · metaal, wit mat of mat zwart, acryl ·  
 metal, estera blanca o estera negra, acrílico · metallo, bianco opaco o nero opaco, acrilico ·  
 metal, alb mat sau negru mat, acrilic · metalli, mattavalkoinen tai mattamusta, akryyli ·  
 metal, biały mat lub czarny mat, akryl



Deckenleuchte · Ceiling lamp  
 Ø 52 cm, ↑ 24 cm  
 excl. 4 x E27, max. 40 W



609800431  
 609800432



Pendelleuchte · Pendant  
 Ø 52 cm, ↑ 150 cm  
 excl. 4 x E27, max. 40 W



309800431  
 309800432



31 | Weiß matt · white mat



32 | Schwarz matt · black mat







Deckenleuchte · Ceiling lamp  
 Ø 40 cm, ↓ 15 cm  
 excl. 3 x E27, max. 25 W



603500331  
 603500332

Empfohlen:  
 recommended: LED E27, 7 W  
 560 lm, 3.000 K



988-700

134



31 | Weiß matt · white mat



32 | Schwarz matt · black mat



Wandleuchte · Wall lamp  
 ↔ 40 x 13 cm, ↗ 6,5  
 incl. 2 x SMD-LED, 6,5 W  
 2 x 700 lm, 3.000 K

223510231  
 223510232



Wandleuchte · Wall lamp  
 ↔ 18 x 13 cm, ↗ 6 cm  
 incl. 1 x SMD-LED, 6,5 W  
 700 lm, 3.000 K

223510131  
 223510132



135

## ZANDOR

Metall, Weiß matt oder Schwarz matt, Acryl · metal, white mat or black mat, acryl ·  
 metale, blanc mat ou noir mat, acryl · metaal, wit mat of mat zwart, acryl ·  
 metal, estera blanca o estera negra, acrílico · metallo, bianco opaco o nero opaco, acrilico ·  
 metal, alb mat sau negru mat, acrilic · metalli, mattavalkoinen tai mattamusta, akryyli ·  
 metal, biały mat lub czarny mat, akryl

Pendelleuchte · Pendant  
 Ø 50 cm, ↓ 150 cm  
 excl. 3 x E27, max. 25 W



303500331  
 303500332

Empfohlen:  
 recommended: LED E27, 7 W  
 560 lm, 3.000 K



988-700







Dimmbar · Dimmable

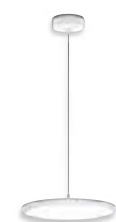

**Pendelleuchte · Pendant**  
 ↓ 150 cm, Ø 40 cm  
 incl. SMD-LED, 29 W  
 3.750 lm, 4.000 K



340910131



**Pendelleuchte · Pendant**  
 ↓ 150 cm, ↔ 90 x 17 cm  
 incl. 3 x SMD-LED, 10 W  
 3 x 1.250 lm, 4.000 K



340910331



**Deckenleuchte · Ceiling lamp**  
 Ø 40 cm, ↓ 12 cm  
 incl. SMD-LED, 29 W  
 3 x 1.250 lm, 4.000 K



640910131



Kippbar · Tilttable

## TRAY

Metall, weiß matt oder schwarz matt · metal, white mat or black mat ·  
 metale, blanc mat ou noir mat · metaal, wit mat of mat zwart ·  
 metal, estera blanca o estera negra · metallo, bianco  
 opaco o nero opaco · metal, alb mat sau negru mat ·  
 metalli, valkoinen matto tai musta matto · metal, biały  
 mat lub czarny mat · metal, beyaz mat veya siyah mat



31 | Weiß matt · white mat

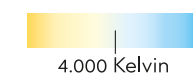

32 | Schwarz matt · black mat



**Pendelleuchte · Pendant**  
 ↓ 150 cm, Ø 40 cm  
 incl. SMD-LED, 29 W  
 3.550 lm, 3.000 K



340910132



**Pendelleuchte · Pendant**  
 ↓ 150 cm, ↔ 90 x 17 cm  
 incl. 3 x SMD-LED, 10 W  
 3 x 1.200 lm, 3.000 K



340910332



**Deckenleuchte · Ceiling lamp**  
 Ø 40 cm, ↓ 12 cm  
 incl. SMD-LED, 29 W  
 3.750 lm, 3.000 K



640910132





# FILO

Metall Schwarz matt, Glas Weiß · metal black mat, glass white ·  
 metale noir mat, verre blanc · metaal mat zwart, glas wit · metal estera negra, vidrio blanco ·  
 metallo nero opaco, vetro bianco · metal negru mat, sticla alb · metalli mattamusta, lasi valkoinen ·  
 metal czarny mat, szkło biały



Pendelleuchte · Pendant  
 ↑ 150 cm, Ø 40 cm  
 excl. 1 x E27, max. 60 W



313900132



Pendelleuchte · Pendant  
 ↔ 100 x 40 cm, ↑ 150 cm  
 excl. 2 x E27, max. 60 W



313900232



Stehleuchte · Floor lamp  
 ↑ 150 cm, ↔ 57,5 cm, Ø 40 cm  
 excl. 1 x E27, max. 60 W



413900132







# TAMIL

Metall oder Metall / Holz naturbelassen · metal or metal / wood natural finish ·  
 métal ou métal / bois finition naturelle · metaal of metaal / hout natuurlijke afwerking ·  
 metal o metal / madera acabado natural · metallo o metallo / di legno finitura naturale ·  
 metal sau metal / lemn finisaj natural · metalli tai metalli / puu luonnollinen viimeistely ·  
 metal lub metal / drewno naturalne wykończenie



08 | Messing matt · brass mat



67 | Nickel antik · nickel antique

Empfohlen:  
 recommended: Filament LED E27, 4,5 W  
 470 lm, 2.700 K



987-400



Deckenleuchte · Ceiling lamp  
 Ø 50 cm, ↑ 22,5 cm  
 excl. 3 x E27, max. 40 W



611100308  
 611100367



Pendelleuchte · Pendant  
 ↑ 150 cm, Ø 50 cm  
 excl. 3 x E27, max. 40 W



311100308  
 311100367





## DISCALGO

Metall, Kunststoff · metal, plastic ·  
 metale, plastique · metaal, kunststof · metal, plástico ·  
 metallo, plastica · metal, plastic · metalli, muovi · metal, plastik



31 | Weiß matt · white mat



32 | Schwarz matt · black mat

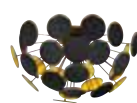

Deckenleuchte · Ceiling lamp  
 Ø 54 cm, ↑ 30 cm  
 excl. 3 x E14, max. 40 W



609900331  
 609900332



Pendelleuchte · Pendant  
 Ø 54 cm, ↑ 150 cm  
 excl. 6 x E14, max. 40 W



309900631  
 309900632







# ROXIE

Metall, Schwarz matt, goldfarbig · metal, black mat, gold ·  
 métal, noir mat, or · metaal, mat zwart, goud · metal, estera negra, oro ·  
 metallo, nero opaco, oro · metal, negru mat, aur · metalli, mattamusta, kultaa ·  
 metal, czarny mat, złota



Pendelleuchte · Pendant  
 ↑ 150 cm, ↔ 115 x 66 cm  
 excl. 7 x E14, max. 40 W



311900632



Pendelleuchte · Pendant  
 ↑ 150 cm, Ø 60 cm  
 excl. 6 x E14, max. 40 W



311900732



Tischleuchte · Table lamp  
 ↑ 43 cm, ↔ 17 cm, ↗ 25,5 cm  
 excl. 1 x E14, max. 40 W



511900132



Stehleuchte · Floor lamp  
 ↑ 155 cm, ↔ 43 cm, ↗ 23 cm  
 excl. 2 x E14, max. 40 W



411900232



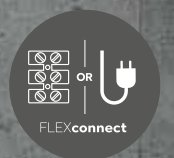

Seite/page 632



# ROXIE

Metall, Schwarz matt, goldfarbig · metal, black mat, gold ·  
 métal, noir mat, or · metaal, mat zwart, goud · metal, estera negra, oro ·  
 metallo, nero opaco, oro · metal, negru mat, aur · metalli, mattamusta, kultaa ·  
 metal, czarny mat, złota



Strahler · Spot  
 ↓ 22,7 cm, ↔ 10 cm, ↗ 15,7 cm  
 excl. 1 x E14, max. 40 W



811900132



Strahler · Spot  
 ↔ 40 x 13,8 cm, ↓ 22,8 cm  
 excl. 2 x E14, max. 40 W



811900232



Strahler · Spot  
 ↔ 60 x 13,8 cm, ↓ 22,8 cm  
 excl. 3 x E14, max. 40 W



811900332



Deckenleuchte · Ceiling lamp  
 Ø 66 cm, ↓ 33 cm  
 excl. 6 x E14, max. 40 W



611900632





# CROSS

Metall, Schwarz matt / goldfarbig · metal, black mat / gold ·  
 metale, noir mat / or · metaal, mat zwart / goud ·  
 metal, estera negra / oro · metallo, nero opaco / oro ·  
 metal, negru mat / aur · metalli, musta matto / kultaa ·  
 metal, czarny mat / złota

Empfohlen:  
 recommended: Filament LED E27, 6 W  
 660 lm, 2.700 K



988-679



Pendelleuchte · Pendant  
 Ø 54,5 cm, ↑ 150 cm  
 excl. 6 x E27, max. 28 W



306700632  
 306700602 | Schwarz · black

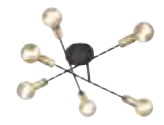

Deckenleuchte · Ceiling lamp  
 Ø 56,6 cm, ↑ 19,1 cm  
 excl. 6 x E27, max. 40 W



606700632



Stehleuchte · Floor lamp  
 ↑ 165 cm, Ø 54,5 cm  
 excl. 6 x E27, max. 28 W



406700632



Pendelleuchte · Pendant  
 ↔ 91 x 45 cm, ↑ 150 cm  
 excl. 7 x E27, max. 28 W



306700732



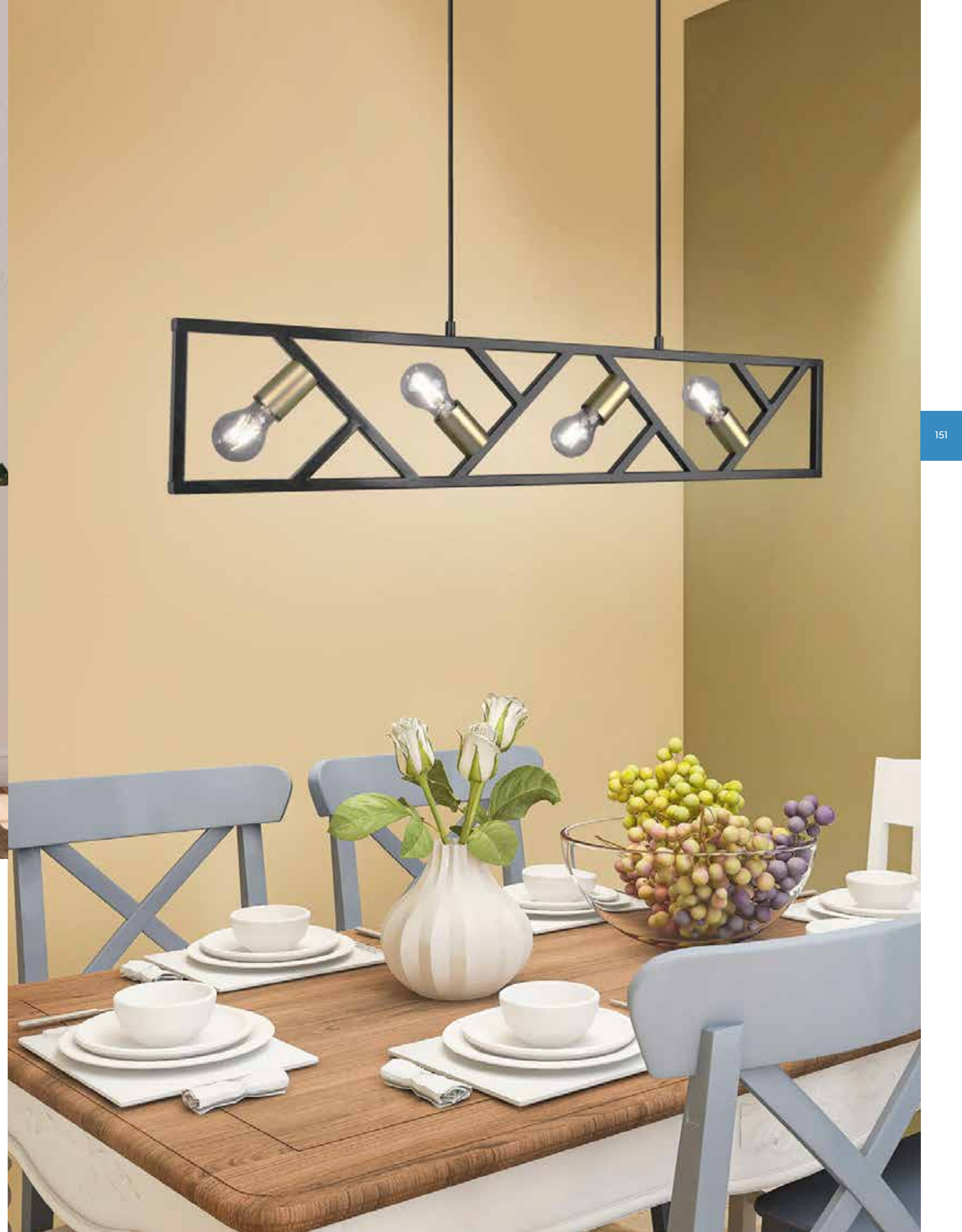

# BELA

Metall, Schwarz matt / goldfarbig · metal, black mat / gold ·  
 metale, noir mat / or · metaal, mat zwart / goud ·  
 metal, estera negra / oro · metallo, nero opaco / oro ·  
 metal, negru mat / aur · metalli, musta matto / kultaa ·  
 metal, czarny mat / złota

Empfohlen:  
 recommended: Filament LED E27, 8 W  
 700 lm, 2.700 K



987-6700



Stehleuchte · Floor lamp  
 ↑ 140,5 cm, ↔ 23 x 16 cm  
 excl. 3 x E27, max. 10 W



407900332

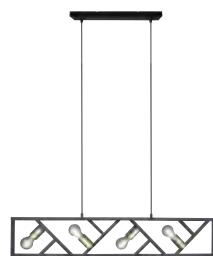

Pendelleuchte · Pendant  
 ↔ 105 x 8,5 cm, ↑ 150 cm  
 excl. 4 x E27, max. 10 W



307900432





## RUSTICA

Metall, rostfarbig, Glas matt · metal, rusty, mat glass ·  
 metale, rouille, verre mat · metaal, roestkleur, mat glas ·  
 metal, óxido, vidrio mate · metallo, ruggine, vetro sabbato ·  
 metal, ruginiu, sticla mata · metalli, rustiikki, mattalasi ·  
 metal, miedz, szklo matowane



Deckenleuchte · Ceiling lamp  
 Ø 55 cm, ↑ 42,5 cm  
 excl. 3 x E27, max. 40 W



601000324



Pendelleuchte · Pendant  
 ↑ 150 cm, Ø 55 cm  
 excl. 3 x E27, max. 40 W



101000324



Pendelleuchte · Pendant  
 ↑ 150 cm, Ø 60 cm  
 excl. 5 x E27, max. 40 W



101000524







## RUSTICA

Metall, rostfarbig, Glas matt · metal, rusty, mat glass ·  
 metale, rouille, verre mat · metaal, roestkleur, mat glas ·  
 metal, óxido, vidrio mate · metallo, ruggine, vetro sabbiato ·  
 metal, ruginiu, sticla mata · metalli, rustiikki, mattalasi ·  
 metal, miedź, szkło matowane



Deckenleuchte · Ceiling lamp  
 Ø 38 cm, ↑ 16,5 cm  
 excl. 2 x E27, max. 60 W



6102021-24



Tischleuchte · Table lamp  
 ↑ 50 cm, Ø 31 cm  
 excl. 2 x E14, max. 40 W



501000224



Stehleuchte · Floor lamp  
 ↑ 180 cm, Ø 33,5 cm  
 excl. 2 x E27, max. 60 W



401000224



Stehleuchte · Floor lamp  
 ↑ 180 cm, Ø 32,5 cm  
 excl. 1 x E27, max. 100 W  
 excl. 1 x E14, max. 40 W



4602021-24







## NAPOLI

Metall, rostfarbig antik mit Acrylapplikationen ·  
 metal, antique rust with acrylic decoration ·  
 métal, rouille antique avec décoration acrylique ·  
 Metaal, roestkleur antiek met acryl decoraties ·  
 Metal, oxido con decoración en acrílico ·  
 metallo, ruggine anticato con decorazione in acrilico ·  
 metal, ruginiu antic cu decoratie acrilica ·  
 metaalia, rustiikki jossa akryyli koristeet ·  
 Metal, antyczny rdzawy z aplikacjami akrylowym

Empfohlen:  
 recommended: Filament LED E14, 4 W  
 470 lm, 2.700 K



989-400



Deckenleuchte · Ceiling lamp  
 Ø 50 cm, ↑ 50 cm  
 excl. 4 x E14, max. 28 W



610300428



Pendelleuchte · Pendant  
 Ø 52 cm, ↑ 150 cm  
 excl. 4 x E14, max. 28 W



110300428







Pendelleuchte · Pendant  
 Ø 70 cm, ↑ 150 cm  
 excl. 3 x E14, max. 40 W



110700328



Pendelleuchte · Pendant  
 Ø 70 cm, ↑ 150 cm  
 excl. 5 x E14, max. 40 W



110700528



Deckenleuchte · Ceiling lamp  
 Ø 61 cm, ↑ 26 cm  
 excl. 3 x E14, max. 40 W



600700328



## TRADITIO

Metall, Glas alabasterfarbig · metal, alabaster-coloured glass ·  
 metale, verre couleur albâtre · metaal, albastkleurig glas ·  
 metal, vidrio de color alabastro · metallo, vetro colore alabastro ·  
 metal, sticla culoare alabastru · metalli, lasi alabasteri väri ·  
 metal, szkło alabaster kolor

Empfohlen:  
 recommended: LED E14, 3,5 W  
 320 lm, 3.000 K



983-40



Wandleuchte · Wall lamp  
 ↔ 12 x 21,5 cm, ↗ 29 cm  
 excl. 1 x E14, max. 40 W



200700128



Tischleuchte · Table lamp  
 ↓ 32 x 16 cm, ↗ 27 cm  
 excl. 1 x E14, max. 40 W



500700128





Seite/page 632



# DIALLO

Metall, Weiß matt oder Schwarz matt · metal, white mat or black mat ·  
 metale, blanc mat ou noir mat · metaal, wit mat of mat zwart ·  
 metal, estera blanca o estera negra · metallo, bianco opaco o nero opaco ·  
 metal, alb mat sau negru mat · metalli, valkoinen matto tai musta matto ·  
 metal, biały mat lub czarny mat

**31** | Weiß matt · white mat

**32** | Schwarz matt · black mat



**Wandleuchte · Wall lamp**  
 ↑ 15 x 10 cm, ↗ 20 cm  
 excl. 1 x E27, max. 42 W



208070131  
 208070132



**Deckenleuchte · Ceiling lamp**  
 Ø 47 cm, ↑ 16,5 cm  
 excl. 3 x E27, max. 42 W



608000331  
 608000332

Empfohlen:  
 recommended: Filament LED E27, 7 W  
 806 lm, 3.000 K



**988-600**

Filament LED E27, 6 W  
 660 lm, 2.700 K



**988-679**

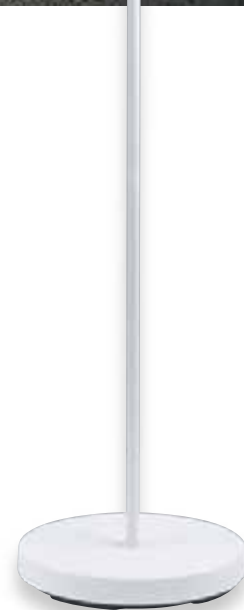

**Tischleuchte · Table lamp**  
 ↑ 51 cm, ↔ 15 cm, ↗ 23,5 cm  
 excl. 1 x E27, max. 42 W



508000131  
 508000132



**Stehleuchte · Floor lamp**  
 ↑ 149 cm, ↔ 23 cm, ↗ 39,3 cm  
 excl. 1 x E27, max. 42 W



408000131  
 408000132





# FLETCHER

Metall · metal ·  
metale · metaal · metal ·  
metallo · metal · metalli · metal

**07** | Nickel matt · nickel mat



**08** | Messing matt / Schwarz matt ·  
brass mat / black mat



**32** | Schwarz matt · black mat



Tischleuchte · Table lamp  
↓ 42,5 cm, ↔ 15 cm, ↗ 31 cm  
excl. 1 x E14, max. 10 W



593400107  
593400108  
593400132



Stehleuchte · Floor lamp  
↓ 143 cm, ↔ 23 cm, ↗ 42 cm  
excl. 1 x E14, max. 10 W



413300107  
413300108  
413300132



Pendelleuchte · Pendant  
↔ 75 x 15 cm, ↓ 150 cm  
excl. 3 x E14, max. 40 W



313300307  
313300308  
313300332



Pendelleuchte · Pendant  
↔ 105 x 15 cm, ↓ 150 cm  
excl. 4 x E14, max. 40 W



313300407  
313300408  
313300432





# JASPER

Metall, Altmessing · metal, old brass ·  
 métal, laiton fumé · metaal, oud brons · metal, bronce viejo ·  
 metallo, ottone invecchiato · metal, bronz antic · metalli, antiikkimessinki ·  
 metal, patyna

Empfohlen:  
 recommended: LED E27, 4,9 W  
 470 lm, 3.000 K



**987-60**

LED E14, 5 W  
 400 lm, 3.000 K



**989-60**



Pendelleuchte · Pendant  
 Ø 31 cm, ↑ 150 cm  
 excl. 1 x E27, max. 60 W



**300500104**



Tischleuchte · Table lamp  
 ↑ 45 cm, ↔ 15 cm, ↗ 23 cm  
 excl. 1 x E14, max. 18 W



**500500104**



Stehleuchte · Floor lamp  
 ↑ 140 cm, ↔ 23 cm, ↗ 52 cm  
 excl. 1 x E14, max. 18 W



**400500104**





Pendelleuchte · Pendant  
 ↓ 150 cm, Ø 115 cm  
 excl. 6 x E14, max. 28 W



302000632  
 302000642

Empfohlen:  
 recommended: LED E14, 3,5 W  
 320 lm, 3.000 K



983-40

LED E14, 4 W  
 470 lm, 2.700 K



983-400



Wandleuchte · Wall lamp  
 ↓ 20,6 cm, ↗ 21,3 cm  
 excl. 1 x E14, max. 28 W



202000132  
 202000142



Tischleuchte · Table lamp  
 ↓ 52 cm, ↔ 18 cm, ↗ 24,2 cm  
 excl. 1 x E14, max. 28 W



502000132  
 502000142



Seite/page 632



## PURE

Metall, Glas · metal, glass ·  
 metale, verre · metaal, glas · metal, vidrio ·  
 metallo, vetro · metal, sticla · metalli, lasi · metal, szkło



32 | Schwarz matt, Glas Weiß ·  
 black mat, glass white



42 | Anthazit, Rauchglas ·  
 anthracite, smoked glass



Pendelleuchte · Pendant  
 ↓ 150 cm, Ø 40 cm  
 excl. 3 x E14, max. 28 W



302000332  
 302000342



Stehleuchte · Floor lamp  
 ↓ 150 cm, ↔ 25 cm, ↗ 31,7 cm  
 excl. 1 x E14, max. 28 W



402000132  
 402000142





Seite/page 632



## PURE

Messing matt, Glas Weiß · brass mat, glass white ·  
 laiton mat, verre blanc · messing mat, glas wit · bronze mate, vidrio blanco ·  
 ottone satinato, vetro bianco · bronz mat,  
 sticla alb · mattamessinki, lasi valkoinen ·  
 mosiądz mat, szkło biały



Wandleuchte · Wall lamp  
 ↓ 20,6 cm, ↗ 21,3 cm  
 excl. 1 x E14, max. 28 W



202000108



Pendelleuchte · Pendant  
 ↓ 150 cm, Ø 40 cm  
 excl. 3 x E14, max. 28 W



302000308



Pendelleuchte · Pendant  
 ↓ 150 cm, Ø 115 cm  
 excl. 6 x E14, max. 28 W



302000608



Tischleuchte · Table lamp  
 ↓ 52 cm, ↔ 18 cm, ↗ 24,2 cm  
 excl. 1 x E14, max. 28 W



502000108



Stehleuchte · Floor lamp  
 ↓ 150 cm, ↔ 25 cm, ↗ 31,7 cm  
 excl. 1 x E14, max. 28 W



402000108





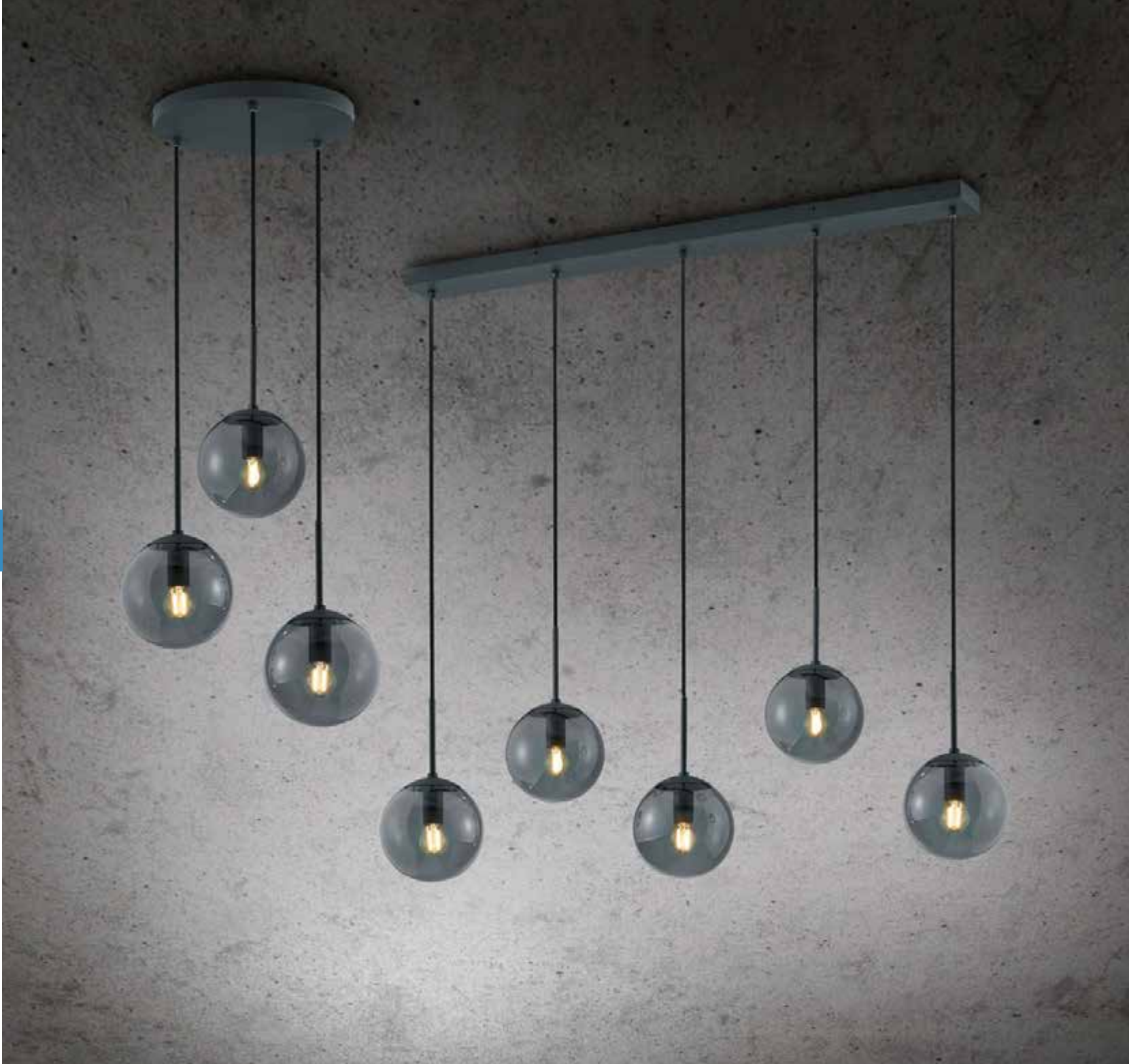

# BALINI

Metall, Anthrazit, Rauchglas · metal, anthracite, smoked glass ·  
 métal, anthracite, verre fumé · metaal, antraciet, rookglas ·  
 metal, antracita, vidrio ahumado · metallo, antracite,  
 vetro fume' · metal, antracit, sticla fumurie · metalli,  
 antrasiitti, savulasi · metal, antracyt, szkło przydymione

Empfohlen:  
 recommended: Filament LED E14, 4 W  
 470 lm, 3.000 K



983-400



Pendelleuchte · Pendant  
 Ø 30 cm, ↑ 150 cm  
 excl. 3 x E14, max. 28 W



308590342



Pendelleuchte · Pendant  
 ↔ 100 x 16 cm, ↑ 150 cm  
 excl. 5 x E14, max. 28 W



308500542

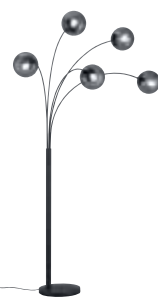

Stehleuchte · Floor lamp  
 ↓ 180 cm, ↔ 30 cm, ↗ 85 cm  
 excl. 5 x E14, max. 28 W



408500542







Deckenleuchte · Ceiling lamp

Ø 45 cm, ↑ 46,5 cm  
excl. 12 x G9, max. 10 W



607601206



Pendelleuchte · Pendant

↑ 150 cm, Ø 45 cm  
excl. 12 x G9, max. 10 W



307601206

# ALICIA

Chrom, Glas rauchfarbig · chrome, glass smoke ·  
chrome, verre fumé · chrom, glas rookkleur ·  
cromo, vidrio humo · cromo, vetro fume' ·  
crom, sticla fumuriu · kromi, lasi savu ·  
chrom, szkło przydymiony

Empfohlen:

recommended: LED G9, 3 W  
300 lm, 3.000 K



929-2300



Tischleuchte · Table lamp

↑ 52 cm, Ø 23 cm  
excl. 6 x G9, max. 5 W



507690606



Stehleuchte · Floor lamp

↑ 155 cm, Ø 25 cm  
excl. 9 x G9, max. 5 W



407690906





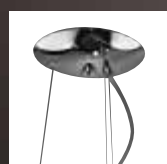

# VAPORE

Chrom, Glas chrom bedampft · chrome, chroom plated glass · chrome, verre plaqué chrome · chroom, chroom opgedampt glas · cromo, vidrio cromado · cromo, vetro verniciato cromo · crom, sticla cromata · kromi, kromipäällystetty lasi · chrom, szkło chromowane

Empfohlen:  
recommended: LED G9, 3 W  
300 lm, 3.000 K  
  **929-2300**



Pendelleuchte · Pendant  
Ø 40 cm, ↑ 150 cm  
excl. 5 x G9, max. 42 W  
 **311210506**



Stehleuchte · Floor lamp  
Ø 40 cm, ↑ 158 cm  
excl. 4 x G9, max. 42 W  
  **411210406**

Deckenleuchte · Ceiling lamp  
Ø 40 cm, ↑ 22 cm  
excl. 5 x G9, max. 42 W  
 **611210506**



Pendelleuchte · Pendant  
Ø 50 cm, ↑ 150 cm  
excl. 6 x G9, max. 42 W  
 **311210606**



Tischleuchte · Table lamp  
Ø 28 cm, ↑ 43 cm  
excl. 3 x G9, max. 42 W  
  **511210306**





## LORENA

Metall, Schwarz matt, Glas chrom bedampft · metal, black mat, chrome plated glass ·  
 métal, noir mat, verre plaqué chrome · metaal, mat zwart, chroom opgedampt glas ·  
 metal, estera negra, vidrio cromado · metallo, nero opaco, vetro verniciato cromo ·  
 metal, negru mat, sticla cromata · metalli, mattamusta, kromipäällystetty lasi ·  
 metal, czarny mat, szkło chromowane



Deckenleuchte · Ceiling lamp  
 Ø 28,5 cm, ↑ 32 cm  
 excl. 1 x E27, max. 40 W



615190132



Pendelleuchte · Pendant  
 ↑ 150 cm, Ø 41 cm  
 excl. 1 x E27, max. 40 W



315190132



Tischleuchte · Table lamp  
 ↑ 30 cm, Ø 28,5 cm  
 excl. 1 x E27, max. 40 W



515190132

Empfohlen:  
 recommended: Filament LED E27, 4 W  
 470 lm, 2.700 K



987-400







## VALENTE

Metall, Glas · metal, glass ·  
 metale, verre · metaal, glas · metal, vidrio ·  
 metallo, vetro · metal, sticla · metalli, lasi · metal, szkło



31 | Weiß matt, Glas klar · white mat, clear glass



42 | Anthrazit, Rauchglas · anthracite smoked glass



Deckenleuchte · Ceiling lamp  
 Ø 40 cm, ↑ 25 cm  
 excl. 3 x E27, max. 60 W



600600331  
 600600342



Pendelleuchte · Pendant  
 Ø 40 cm, ↑ 150 cm  
 excl. 3 x E27, max. 60 W



300600331  
 300600342







Pendelleuchte · Pendant  
 ↓ 150 cm, Ø 10 cm  
 excl. 1 x E27, max. 28 W



- 310600101
- 310600132
- 310600154



Pendelleuchte · Pendant  
 ↓ 150 cm, Ø 37 cm  
 excl. 3 x E27, max. 28 W



- 310630301
- 310630332
- 310630354



Pendelleuchte · Pendant  
 ↓ 150 cm, ↔ 80,5 cm  
 excl. 4 x E27, max. 28 W



- 310600401
- 310600432
- 310600454



Tischleuchte · Table lamp  
 ↓ 25,5 cm, Ø 11 cm  
 excl. 1 x E27, max. 28 W



- 510600101
- 510600132
- 510600154

# ROBIN

Metall, Glas · metal, glass ·  
 metale, verre · metaal, glas · metal, vidrio ·  
 metallo, vetro · metal, sticla · metalli, lasi · metal, szkło

01 | Schwarz matt, Glas weiß · black mat, glass white

32 | Schwarz matt, Glas rauchfarbig · black mat, glass smoke

54 | Messing matt, Glas rauchfarbig · brass mat, glass smoke





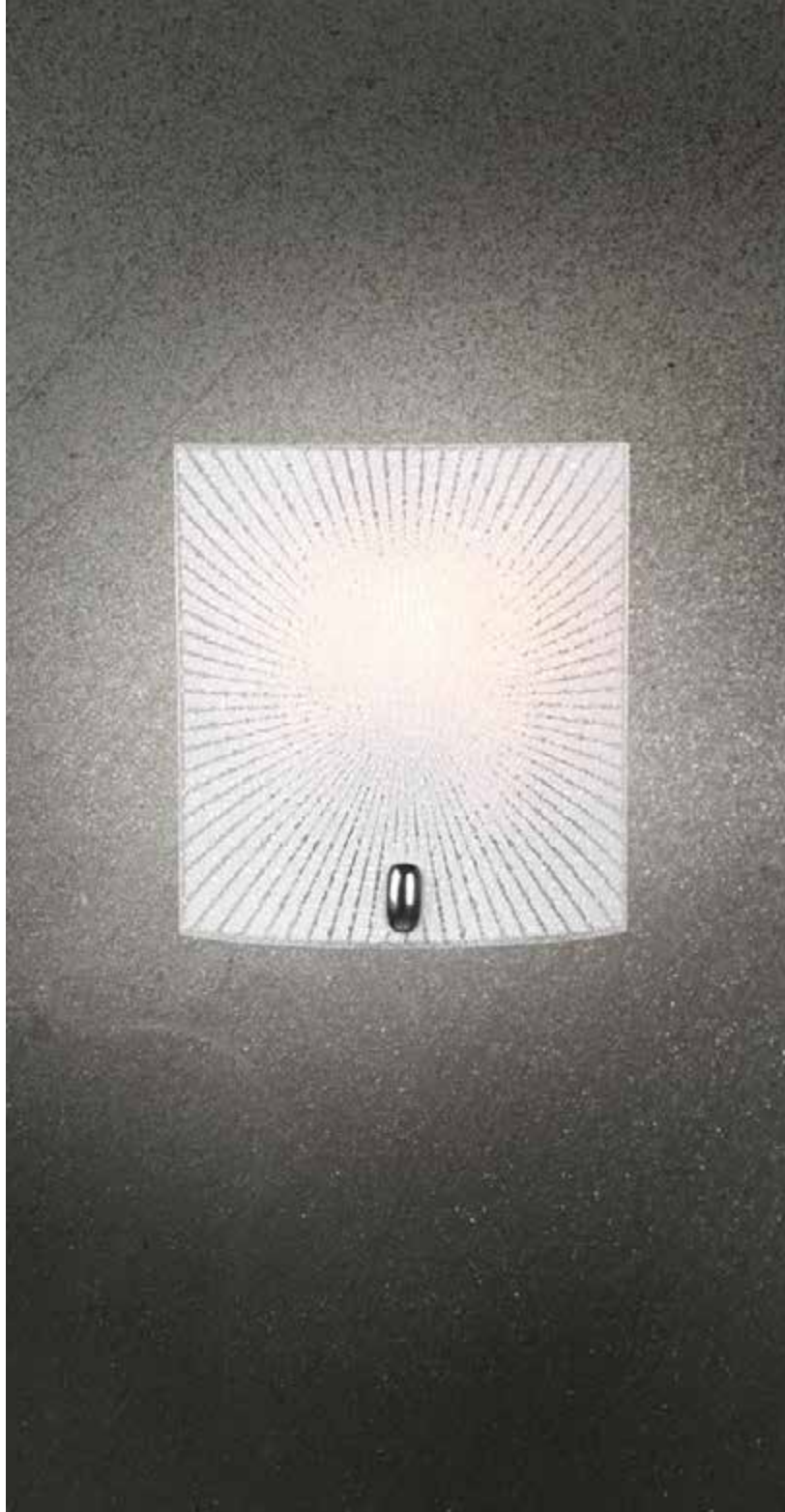
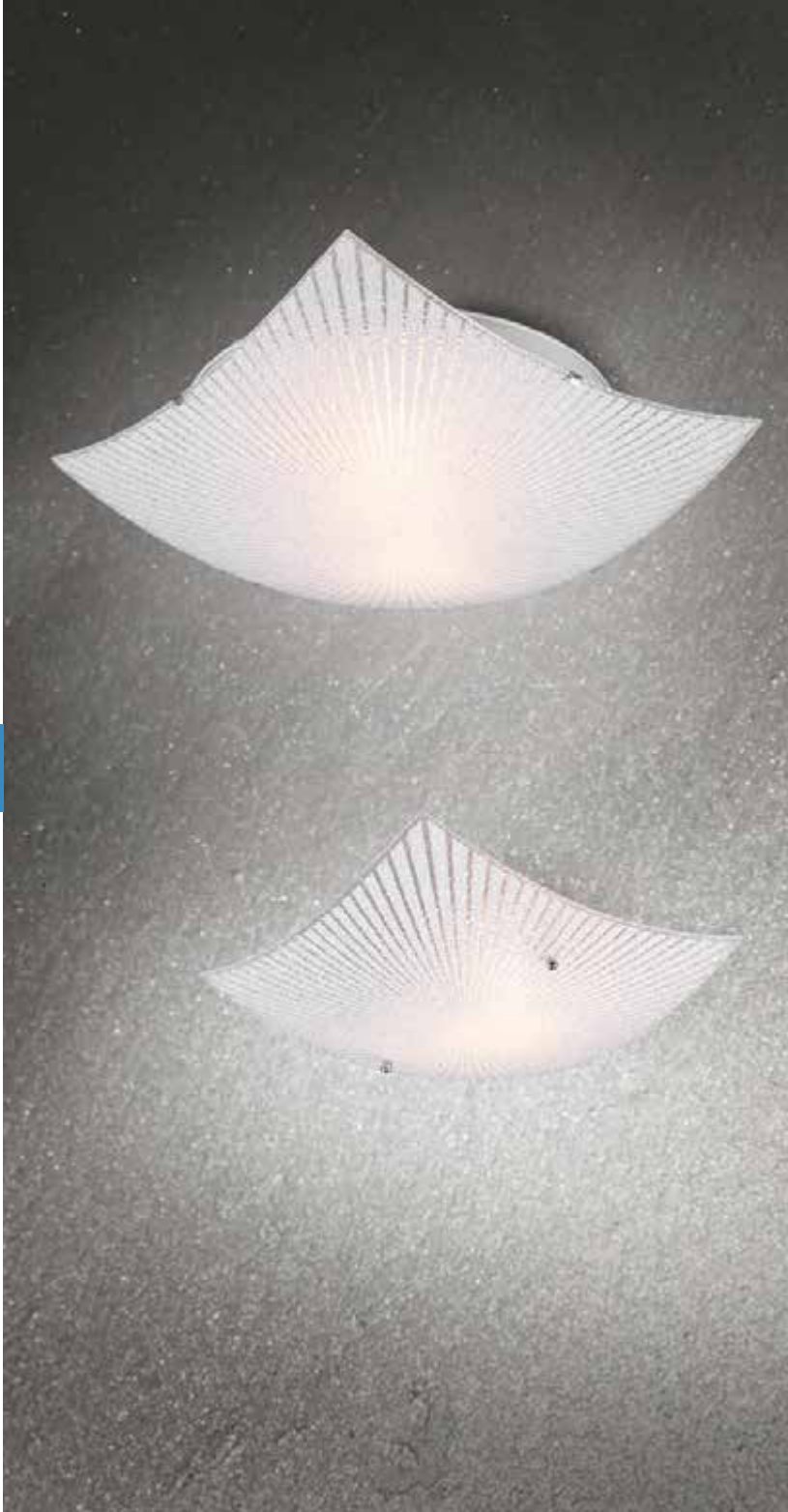

# ELISA

Metall, Glas · metal, glass ·  
 métal, verre · metaal, glas · metal, vidrio ·  
 metallo, vetro · metal, sticla · metalli, lasi · metal, szkło



Deckenleuchte · Ceiling lamp  
 ↔ 40 x 40 cm, ↑ 9,5 cm  
 excl. 2 x E27, max. 40 W



612200200



Deckenleuchte · Ceiling lamp  
 ↔ 30 x 30 cm, ↑ 9 cm  
 excl. 1 x E27, max. 40 W



612200100



Wandleuchte · Wall lamp  
 ↓ 22 cm, ↔ 20 cm, ↗ 8,5 cm  
 excl. 1 x E27, max. 40 W



212200100



Pendelleuchte · Pendant  
 ↓ 150 cm, ↔ 40 x 20 cm  
 excl. 2 x E27, max. 40 W



312200200

Empfohlen:  
 recommended: Filament LED E27, 4 W  
 470 lm, 2.700 K



987-400







# SPIRELLI

Chrom, Dekorglas Weiß · chrome, glas decorated white · chrome, verre décoré blanc · chromium, decoratief glas wit · cromo, vidrio decorado blanco · cromo, vetro decorato bianco · crom, sticla decorativa alb · kromi, ornamenttilasi valkoinen · chrom, szkło dekoracyjne biały



Deckenleuchte · Ceiling lamp  
↔ 30 x 30 cm, ↓ 9 cm  
excl. 1 x E27, max. 40 W

Deckenleuchte · Ceiling lamp  
↔ 40 x 40 cm, ↓ 9,5 cm  
excl. 2 x E27, max. 40 W

Deckenleuchte · Ceiling lamp  
↔ 50 x 50 cm, ↓ 11 cm  
excl. 3 x E27, max. 40 W



604400101



604400201



604400301



Wandleuchte · Wall lamp  
↔ 30 x 22 cm, ↓ 7,5 cm  
excl. 1 x E27, max. 40 W



204400101



Pendelleuchte · Pendant  
↔ 40 x 20 cm, ↓ 150 cm  
excl. 2 x E27, max. 40 W



304400201





Wandleuchte · Wall lamp  
↔ 30 x 22 cm, ↗ 7,5 cm  
excl. 1 x E27, max. 40 W



208700179 | goldfarbig · gold  
208700189 | silberfarbig · silver



Deckenleuchte · Ceiling lamp  
↔ 30 x 30 cm, ↓ 9 cm  
excl. 1 x E27, max. 40 W



608700189



Deckenleuchte · Ceiling lamp  
↔ 40 x 40 cm, ↓ 9,5 cm  
excl. 2 x E27, max. 40 W



608700289

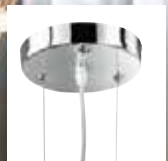

## NIKOSIA

Dekorglas · glas decorated ·  
verre décoré · decoratief glas ·  
vidrio decorado · vetro decorato ·  
sticla decorativa · ornamenttilasi ·  
szkło dekoracyjne



Pendelleuchte · Pendant  
Ø 14 cm, ↓ 150 cm  
excl. 1 x E27, max. 40 W



308700189



Pendelleuchte · Pendant  
↔ 50 x 20 cm, ↓ 150 cm  
excl. 2 x E27, max. 40 W



308700289





## SANDRINA

Dekorglas · glas decorated ·  
verre décoré · decoratief glas · vidrio decorado ·  
vetro decorato · sticla decorativa · ornamenttilasi · szkło dekoracyjne



Wandleuchte · Wall lamp  
↔ 30 x 15 cm, ↗ 8 cm  
excl. 1 x E27, max. 40 W



201200100



Deckenleuchte · Ceiling lamp  
Ø 30 cm, ↓ 9 cm  
excl. 1 x E27, max. 40 W



601200100



Deckenleuchte · Ceiling lamp  
Ø 40 cm, ↓ 10 cm  
excl. 2 x E27, max. 40 W



601200200



Pendelleuchte · Pendant  
Ø 50 cm, ↓ 150 cm  
excl. 3 x E27, max. 40 W



301200300



## SIGNA

Chrom, Dekorglas Weiß · chrome, glas decorated white ·  
chrome, verre décoré blanc · chromium, decoratief glas wit ·  
cromo, vidrio decorado blanco · cromo, vetro decorato bianco ·  
crom, sticla decorativa alb · kromi, ornamenttilasi valkoinen ·  
chrom, szkło dekoracyjne biały



Wandleuchte · Wall lamp  
↔ 20 x 30 cm, ↗ 9 cm  
excl. 1 x E27, max. 40 W



202500101



Deckenleuchte · Ceiling lamp  
↔ 30 x 30 cm, ↓ 9 cm  
excl. 1 x E27, max. 40 W



602500101



Deckenleuchte · Ceiling lamp  
↔ 40 x 40 cm, ↓ 9,5 cm  
excl. 2 x E27, max. 40 W



602500201



Pendelleuchte · Pendant  
Ø 50 cm, ↓ 150 cm  
excl. 3 x E27, max. 40 W



302500301





## SWEETY

Acryl · acryl ·  
acryl · acryl · acrílico · acrílico ·  
acrilic · akryyli · akryl



Wandleuchte · Wall lamp  
↔ 20 x 20 cm, ↑ 9 cm  
excl. 1 x E14, max. 40 W



207800100



Deckenleuchte · Ceiling lamp  
Ø 30 cm, ↑ 10,5 cm  
excl. 1 x E27, max. 60 W



607800100



Pendelleuchte · Pendant  
Ø 30 cm, ↑ 150 cm  
excl. 1 x E27, max. 60 W



307800100



Pendelleuchte · Pendant  
Ø 40 cm, ↑ 150 cm  
excl. 1 x E27, max. 60 W



307804100



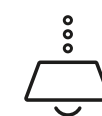

## Pendelleuchten & Kronen

Pendants & chandeliers  
Lustres & suspensions  
Hanglampen & kroonluchters  
Colgantes y Lámparas  
Lampadari e sospensioni  
Lustre si pendule  
Riippu- & kruunu  
Wiszące i żyrandole



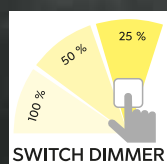

# MADISON

Metall, Schwarz matt, Rauchglas · metal, black mat, smoked glass · métal, noir mat, verre fumé · metaal, mat zwart, rookglas · metal, estera negra, vidrio ahumado · metallo, nero opaco, vetro fume' · metal, negru mat, sticla fumurie · metalli, mattamusta, savulasi · metal, czarny mat, szkło przydymione

 Höhenverstellbar · Adjustable height



**Pendelleuchte · Pendant**  
 † 95 - 150 cm, Ø 18 cm  
 incl. 1 x SMD-LED, 8 W  
 900 lm, 3.000 K



342010132



**Pendelleuchte · Pendant**  
 † 95 - 150 cm, ↔ 52 cm, Ø 18 cm  
 incl. 2 x SMD-LED, 8 W  
 2 x 900 lm, 3.000 K



342010232



**Pendelleuchte · Pendant**  
 † 95 - 150 cm, ↔ 82 cm, Ø 18 cm  
 incl. 3 x SMD-LED, 8 W  
 3 x 900 lm, 3.000 K



342010332





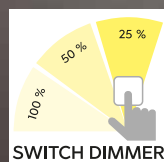

SWITCH DIMMER



# MADISON

Metall, Glas · metal, glass ·  
 metale, verre · metaal, glas · metal, vidrio ·  
 metallo, vetro · metal, sticla · metalli, lasi ·  
 metal, szkło

 Höhenverstellbar ·  
 Adjustable height

 **07** | Nickel matt · nickel mat

 **08** | Messing matt · brass mat

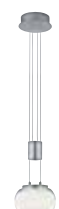

**Pendelleuchte · Pendant**  
 † 95 - 150 cm, Ø 18 cm  
 incl. 1 x SMD-LED, 8 W  
 900 lm, 3.000 K



342010107  
 342010108



**Pendelleuchte · Pendant**  
 † 95 - 150 cm, ↔ 52 cm, Ø 18 cm  
 incl. 2 x SMD-LED, 8 W  
 2 x 900 lm, 3.000 K



342010207  
 342010208



**Pendelleuchte · Pendant**  
 † 95 - 150 cm, ↔ 82 cm, Ø 18 cm  
 incl. 3 x SMD-LED, 8 W  
 3 x 900 lm, 3.000 K



342010307  
 342010308



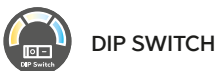
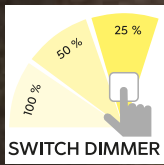
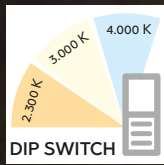

Lichtfarben direkt an der Leuchte einstellbar · Colours directly adjustable at the lamp ·  
 Les couleurs de la lumière peuvent être réglées directement sur le luminaire ·  
 Lichtkleuren direct instelbaar op de lamp · Tonalidades de luz ajustables directamente en la lámpara ·  
 Colori della luce regolabili direttamente sulla lampada · Colori ale luminii reglabile direct de la bec ·  
 Valon väri asetettävissa suoraan valaisimesta · Barwy światła można ustawić bezpośrednio na oprawie



# MORRISON

Metall, Acryl · metal, acryl ·  
 metale, acryl · metaal, acryl · metal, acrílico ·  
 metallo, acrilico · metal, acrilic · metalli, akryyli · metal, akryl

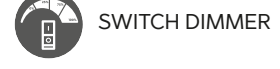

07 | Nickel matt · nickel mat



31 | Weiß matt · white mat



32 | Schwarz matt · black mat

Pendelleuchte · Pendant  
 ↔ 90 x 50 cm, ↑ 150 cm  
 incl. SMD-LED, 56 W  
 6.800 lm, 2.300 + 3.000 + 4.000 K



323610307  
 323610331  
 323610332



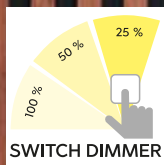

# DURBAN

Metall, Nickel matt oder Anthrazit · metal, nickel mat or anthracite ·  
 metale, nickel mat ou antracite · metaal, nikkel mat of antraciet ·  
 metal, níquel mate o antracita · metallo, nichel opaco o antracite ·  
 metal, nichel mat sau antracit · metalli, harjattu teräs tai antrasiitti ·  
 metal, nikiel mat lub antracyt



07 | Nickel matt · nickel mat

42 | Anthrazit · anthracite



**Pendelleuchte · Pendant**  
 Ø 60,3 cm, ↓ 200 cm  
 incl. SMD-LED, 40 W  
 5.000 lm, 3.000 K



321910207  
 321910242



**Pendelleuchte · Pendant**  
 Ø 80,3 cm, ↓ 200 cm  
 incl. SMD-LED, 75 W  
 8.000 lm, 3.000 K



321910307  
 321910342





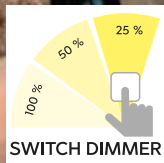

# CURL

Metall, Weiß matt, Schwarz matt oder goldfarbig · metal, white mat, black mat or gold ·  
metale, blanc mat, noir mat ou or · metaal, wit mat, mat zwart of goud · metal, estera blanca, estera negra o oro · metallo, bianco opaco, nero opaco o oro ·  
metal, alb mat, negru mat sau aur · metalli, mattavalkoinen, mattamusta tai kultaa · metal, biały mat, czarny mat lub złota

-  **31** | Weiß matt · white mat  
4.000 Kelvin
-  **32** | Schwarz matt · black mat
-  **79** | goldfarbig · gold



**Pendelleuchte · Pendant**  
Ø 55 cm, ↓ 150 cm  
incl. SMD-LED, 33 W  
5.000 lm, 3.000 K  
(31 = 5.000 lm, 4.000 K)

  
325110131  
325110132  
325110179

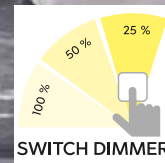

# MACAU

Aluminium gebürstet · brushed aluminium ·  
aluminium balayé · geborsteld aluminium · aluminio pulido ·  
alluminio spazzolato · aluminiiu lucios · harjattu alumiini ·  
aluminium szczotkwane

**Pendelleuchte · Pendant**  
Ø 75 cm, ↓ max. 200 cm  
incl. SMD-LED, 64 W  
6.000 lm, 3.000 K

  
325610305





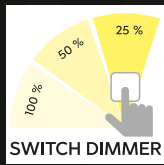

# TUBULAR

Metall, Weiß matt oder Schwarz matt · metal, white mat or black mat ·  
 metal, blanc mat ou noir mat · metaal, wit mat of mat zwart ·  
 metal, estera blanca o estera negra · metallo, bianco opaco o nero opaco ·  
 metal, alb mat sau negru mat · metalli, valkoinen matto tai musta matto ·  
 metal, biały mat lub czarny mat



31 | Weiß matt · white mat

32 | Schwarz matt · black mat



Pendelleuchte · Pendant  
 Ø 40 cm, ↑ 150 cm  
 incl. 11 x SMD-LED, 2,8 W  
 11 x 350 lm, 3.000 K



321691131  
 321691132

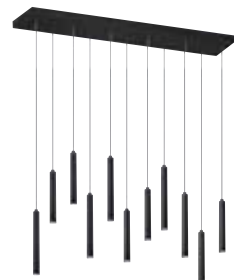

Pendelleuchte · Pendant  
 ↔ 115 x 15 cm, ↑ 150 cm  
 incl. 11 x SMD-LED, 2,8 W  
 11 x 350 lm, 3.000 K



321611131  
 321611132





Pendelleuchte · Pendant  
 ↔ 95 - 150 cm, ↑ 95 - 150 cm  
 incl. SMD-LED, 45 W, 5.300 lm  
 incl. 2 x SMD-LED, 6 W, 2 x 500 lm  
 2.700 - 5.000 K



- 375310502
- 375310505
- 375310507
- 375310508
- 375310532



- 02** | Schwarz / Messing matt · black / brass mat
- 05** | Aluminium gebürstet · brushed aluminium
- 07** | Nickel matt · nickel mat
- 08** | Messing matt · brass mat
- 32** | Schwarz matt · black mat

# TRAJAN

Metall · metal ·  
 metale · metaal · metal · metallo · metal · metalli · metal

 Lichtfarbe stufenlos einstellbar ·  
 Light color infinitely variable

 4 fach TOUCH ·  
 4 level Touch function

Ausziehbar · Extendible · extensible · Verlengbaar ·  
 Extensibile · Estensibile · extensibil · Jatkettava · Rozsuwalny

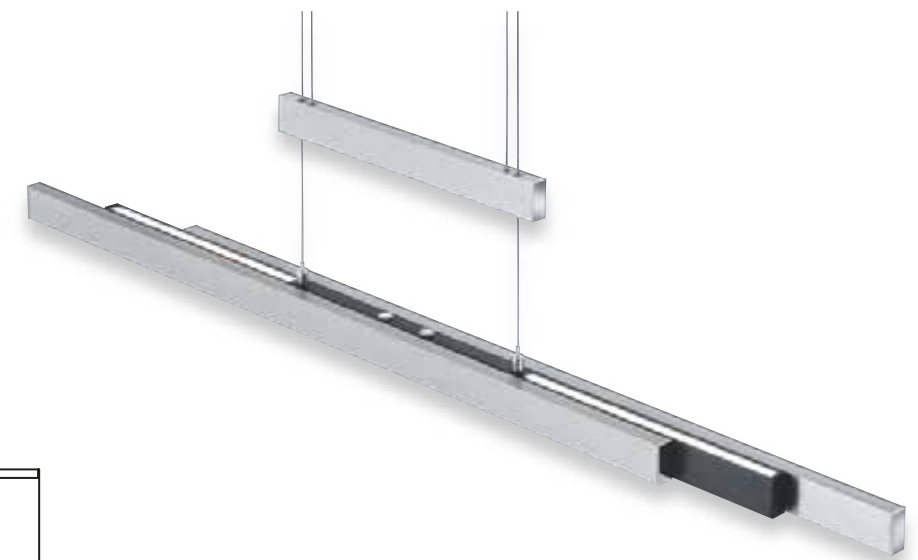
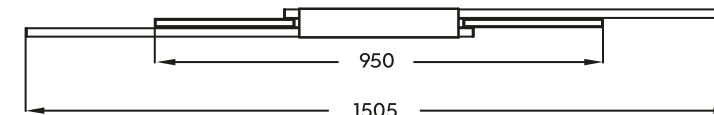





LIFT ME

Innovative Höhenverstellung ohne Gegengewicht · Innovative height adjustment without counterweight · Nouveau! Réglage de la hauteur sans contrepoids · Innovatieve hoogteverstelling zonder contragewicht · Innovador sistema de ajuste de altura sin necesidad de contrapeso · Regolazione innovativa dell'altezza senza contrappeso · Ajustare inovativa a inaltimii fara contragreutate · Innovatiivinen korkeuden säätö ilman vastapainoa · Innowacyjna regulacja wysokości bez przeciwwagi

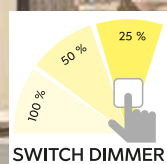

SWITCH DIMMER

## ALEGRO

Nickel matt, Glas weiß · nickel mat, glass white · nickel mat, verre blanc · nikkel mat, glas wit · níquel mate, vidrio blanco · nichel opaco, vetro bianco · nichel mat, sticla alb · harjattu teräs, lasi valkoinen · nikiel mat, szkło biały



**Pendelleuchte · Pendant**  
↔ 100 x 12 cm, ↑ 95 - 160 cm  
incl. 4 x SMD-LED, 6,5 W  
4 x 700 lm, 3.000 K



325510407



**Pendelleuchte · Pendant**  
↔ 130 x 12 cm, ↑ 95 - 160 cm  
incl. 5 x SMD-LED, 6,5 W  
5 x 700 lm, 3.000 K



325510507

## LACAL

Nickel matt oder goldfarbig · nickel mat or gold · nickel mat ou or · nikkel mat of goud · níquel mate o oro · nichel opaco o oro · nichel mat sau aur · harjattu teräs tai kultaa · nikiel mat lub złota

Gibt Licht nach oben und unten · up and down lighting · point lumineux en haut et en bas · lichtpunt boven en onder · luz de arriba y abajo · luce su e giù · sus și în jos lumina · ylös ja alas valoa · w górę iw dół światło



Lichtfarbe einstellbar · Adjustable light color



4 fach TOUCH · 4 level Touch function

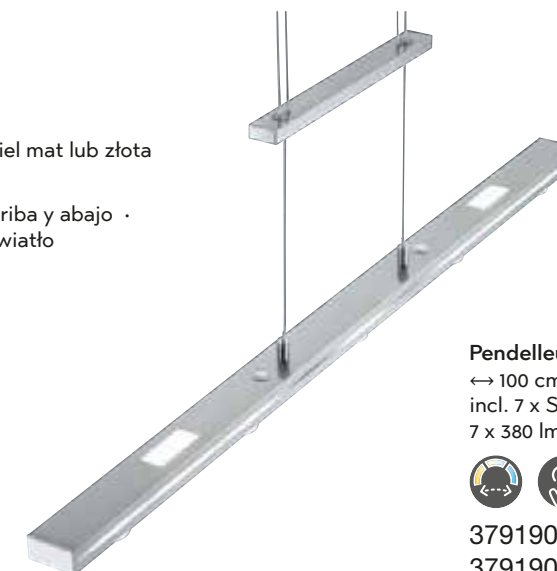

**Pendelleuchte · Pendant**  
↔ 100 cm, ↑ 95 - 160 cm  
incl. 7 x SMD-LED, 4 W  
7 x 380 lm, 3.000 + 5.000 K



379190707 | Nickel matt · nickel mat  
379190732 | Schwarz matt · black mat



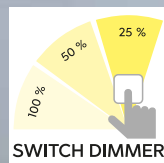

SWITCH DIMMER

# AICK

Metall, Aluminium gebürstet oder Schwarz matt · metal, brushed aluminium or black mat · metale, aluminium balayé ou noir mat · metaal, geborsteld aluminium of mat zwart · metal, aluminio pulido o estera negra · metallo, alluminio spazzolato o nero opaco · metal, aluminiiu lucios sau negru mat · metalli, harjattu alumiini tai mattamusta · metal, aluminium szczotkowane lub czarny mat

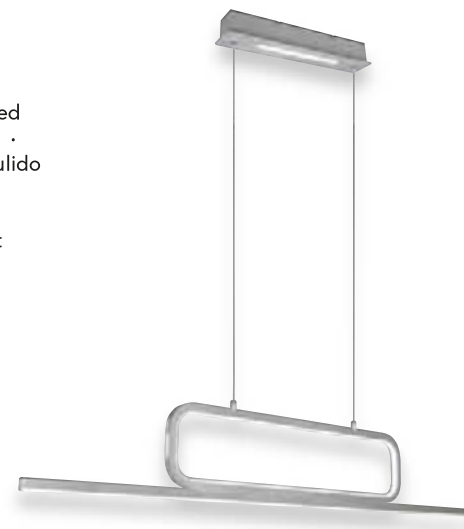

**Pendelleuchte · Pendant**  
 ↔ 110 x 7,5 cm, ↓ 150 cm  
 incl. SMD-LED, 38 W  
 4.500 lm, 3.000 K



327210305 | Aluminium gebürstet · brushed aluminium  
 327210332 | Schwarz matt · black mat

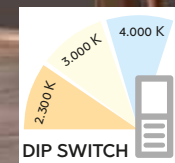

DIP SWITCH

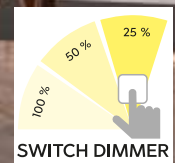

SWITCH DIMMER

# GRANT

Aluminium gebürstet oder Messing matt, Schwarz matt · brushed aluminium or brass mat, black mat · aluminium balayé ou laiton mat, noir mat · geborsteld aluminium of messing mat, mat zwart · aluminiiu pulido o bronce mate, estera negra · alluminio spazzolato o ottone satinato, nero opaco · aluminiiu lucios sau bronz mat, negru mat · harjattu alumiini tai mattamessinki, mattamusta · aluminium szczotkowane lub mosiądz mat, czarny mat



05 | Aluminium gebürstet · brushed aluminium

08 | Messing matt · brass mat



**Pendelleuchte · Pendant**  
 ↔ 138 x 12 cm, ↓ 150 cm  
 incl. SMD-LED, 54 W  
 6.500 lm, 2.300 + 3.000 + 4.000 K



342710205  
 342710208





# LUMINA

Metall, Schwarz matt, Glas chrom bedampft · Metal, black mat, chrome plated glass ·  
 métal, noir mat, verre plaqué chrome · metaal, mat zwart, chroom opgedampt glas ·  
 metal, estera negra, vidrio cromado · metallo, nero opaco, vetro verniciato cromo ·  
 metal, negru mat, sticla cromata · metalli, mattamusta, kromipäällystetty lasi ·  
 metal, czarny mat, szkło chromowane

Empfohlen:  
 recommended: Filament LED E14, 4 W  
 470 lm, 2.700 K



983-400



Pendelleuchte · Pendant  
 ↔ 60 x 6,5 cm, ↑ 150 cm  
 excl. 3 x E14, max. 40 W



317000332



Pendelleuchte · Pendant  
 ↔ 85 x 20 cm, ↑ 150 cm  
 excl. 6 x E14, max. 40 W



317000632



Pendelleuchte · Pendant  
 ↔ 115 x 20 cm, ↑ 150 cm  
 excl. 8 x E14, max. 40 W



317000832







# CLAYTON

Metall schwarz matt, Glas chrom bedampft · metal black mat, chrome plated glass ·  
 métal noir mat, verre plaqué chrome · metaal mat zwart, chroom opgedampt glas ·  
 metal estera negra, vidrio cromado · metallo nero opaco, vetro verniciato cromo ·  
 metal negru mat, sticla cromata · metalli mattamusta, kromipäällystetty lasi ·  
 metal czarny mat, szkło chromowane

Empfohlen:  
 recommended: Filament LED E27, 4 W  
 470 lm, 2.700 K



987-400



Pendelleuchte · Pendant  
 Ø 20 cm, ↓ 150 cm  
 excl. 1 x E27, max. 28 W



310300132



Pendelleuchte · Pendant  
 Ø 45 cm, ↓ 150 cm  
 excl. 3 x E27, max. 28 W



310390332



Pendelleuchte · Pendant  
 ↔ 115 cm, ↓ 150 cm  
 excl. 5 x E27, max. 28 W



310300532







# MELA

Metall, Weiß matt oder Schwarz matt, Glas · metal, white mat or black mat, glass ·  
 métal, blanc mat ou noir mat, verre · metaal, wit mat of mat zwart, glas ·  
 metal, estera blanca o estera negra, vidrio · metallo, bianco opaco o nero opaco, vetro ·  
 metal, alb mat sau negru mat, sticla · metalli, mattavalkoinen tai mattamusta, lasi ·  
 metal, biały mat lub czarny mat, szkło

Empfohlen:  
 recommended: Filament LED E14, 4 W  
 470 lm, 2.700 K



983-400



31 | Weiß matt · white mat



32 | Schwarz matt · black mat



Pendelleuchte · Pendant  
 Ø 33 cm, ↑ 150 cm  
 excl. 5 x E14, max. 40 W



313100531  
 313100532

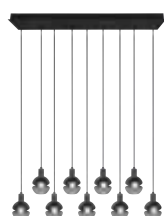

Pendelleuchte · Pendant  
 ↔ 102 x 22 cm, ↑ 150 cm  
 excl. 9 x E14, max. 40 W



313100931  
 313100932





Empfohlen:  
recommended: Filament LED E27, 7 W  
806 lm, 3.000 K



988-600

Filament LED E27, 6 W  
660 lm, 2.700 K



988-679

# CLERMONT

Metall · metal ·  
metale · metaal · metal · metallo · metal · metalli · metal



07 | Nickel matt · nickel mat



31 | Weiß matt · white mat



32 | Schwarz matt · black mat



Pendelleuchte · Pendant  
↑ 150 cm, Ø 10 cm  
excl. 1 x E27, max. 10 W



313400107  
313400131  
313400132



Pendelleuchte · Pendant  
↔ 70 x 9 cm, ↑ 150 cm  
excl. 4 x E27, max. 10 W



313400407  
313400431  
313400432



Pendelleuchte · Pendant  
↔ 110 x 9 cm, ↑ 150 cm  
excl. 6 x E27, max. 10 W



313400607  
313400631  
313400632







# MARLEY

Metall · metal ·  
metale · metaal · metal · metallo ·  
metal · metalli · metal · metal

-  **01** | Weiß · white
-  **07** | Nickel matt · nickel mat
-  **31** | Weiß matt · white mat
-  **32** | Schwarz matt · black mat

Empfohlen:  
recommended: LED GU10, 4,5 W  
345 lm, 3.000 K



956-55



**Pendelleuchte · Pendant**  
↓ 150 cm, ↔ 12 x 12 cm, Ø 6 cm  
excl. 1 x GU10, max. 35 W



312400101  
312400107  
312400132

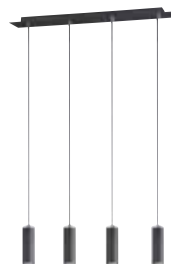

**Pendelleuchte · Pendant**  
↔ 75 x 9 cm, ↓ 150 cm  
excl. 4 x GU10, max. 35 W



312400401  
312400407  
312400432



**Pendelleuchte · Pendant**  
↔ 80 x 18 cm, ↓ 150 cm  
excl. 4 x GU10, max. 35 W



302400407  
302400431  
302400432



**Pendelleuchte · Pendant**  
↔ 115 x 20 cm, ↓ 150 cm  
excl. 6 x GU10, max. 35 W



302400607  
302400631  
302400632





# MARLEY

Metall, Altmessing oder Schwarz-Gold · metal, old brass or black-gold ·  
 métal, laiton fumé ou noir et or · metaal, oud brons of zwart-goud ·  
 metal, bronce viejo o negro-oro · metallo, ottone invecchiato o oro nero ·  
 metal, bronz antic sau negru-auriu · metalli, antiikkimessinki tai musta-kulta ·  
 metal, patyna lub czarno złoty

Empfohlen:  
 recommended: LED GU10, 4,5 W  
 345 lm, 3.000 K



**956-55**

-  **04** | Altmessing · old brass
-  **80** | Schwarz-Gold · black-gold



**Pendelleuchte · Pendant**  
 ↔ 80 x 18 cm, ↑ 150 cm  
 excl. 4 x GU10, max. 35 W



**302400404**  
**302400480**



**Pendelleuchte · Pendant**  
 ↔ 115 x 20 cm, ↑ 150 cm  
 excl. 6 x GU10, max. 35 W



**302400604**  
**302400680**



# MARLEY

Metall, Holz · metal, wood ·  
 Métal, bois · Metaal, hout · Metal, madera ·  
 Metallo, di legno · Metal, lemn · Metalli, puu ·  
 Metal, drewno

-  **07** | Nickel matt / Holz · nickel mat / wood
-  **31** | Weiß matt / Holz · white mat / wood
-  **32** | Schwarz matt / Holz · black mat / wood

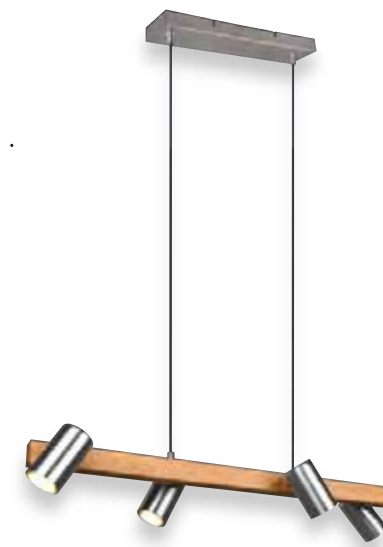

**Pendelleuchte · Pendant**  
 ↔ 80 x 18 cm, ↑ 150 cm  
 excl. 4 x GU10, max. 35 W



**312490407**  
**312490431**  
**312490432**



**Pendelleuchte · Pendant**  
 ↔ 115 x 20 cm, ↑ 150 cm  
 excl. 6 x GU10, max. 35 W



**312490607**  
**312490631**  
**312490632**





# ONYX

Metall, Anthrazit, innen goldfarbig · metal, anthracite, gold colored inside ·  
 metale, antracite, Or · metaal, antraciet, Binnenkant goudkleur ·  
 metal, antracita, Interior en color dorado ·  
 metallo, antracite, interno colore oro ·  
 metal, antracit, interior culoare aurie ·  
 metalli, antrasiitti, sisäosa kullanvärinen ·  
 metal, antracyt, wewnątrz złoty



Pendelleuchte · Pendant  
 Ø 15 cm, ↑ 150 cm  
 excl. 1 x E27, max. 42 W



301300142



Pendelleuchte · Pendant  
 Ø 35 cm, ↑ 150 cm  
 excl. 3 x E27, max. 42 W



301300342



Pendelleuchte · Pendant  
 ↔ 90 x 15 cm, ↑ 150 cm  
 excl. 4 x E27, max. 42 W



301300442





# CHIRON

Aluminium, Messing matt, Schwarz matt · aluminium, brass mat, black mat · aluminium, laiton mat, noir mat · aluminium, messing mat, mat zwart · aluminio, bronce mate, estera negra · alluminio, ottone satinato, nero opaco · aluminiu, bronz mat, negru mat · alumiini, mattamessinki, mattamusta · aluminium, mosiądz mat, czarny mat



Pendelleuchte · Pendant  
Ø 20 cm, ↑ 150 cm  
excl. 1 x E27, max. 40 W



310800108



Pendelleuchte · Pendant  
Ø 45 cm, ↑ 150 cm  
excl. 1 x E27, max. 40 W



310890108



Pendelleuchte · Pendant  
↔ 90 x 20 cm, ↑ 150 cm  
excl. 3 x E27, max. 40 W



310800308

# LIVIA

Metall Schwarz matt, goldfarbig · metal black mat, gold · metale noir mat, or · metaal mat zwart, goud · metal estera negra, oro · metallo nero opaco, oro · metal negru mat, aur · metalli musta matto, kultaa · metal czarny mat, złota

Empfohlen:  
recommended: Filament LED E14, 4 W  
470 lm, 3.000 K



990-400



Pendelleuchte · Pendant  
Ø 46,8 cm, ↑ 150 cm  
excl. 3 x E14, max. 40 W



101700332



Pendelleuchte · Pendant  
Ø 57,5 cm, ↑ 150 cm  
excl. 5 x E14, max. 40 W



101700532





# CORTEZ

Metall, Stoffschirm · metal, fabric shade ·  
 metale, abat-jour tissu · metaal, Stoffen kap · metal, Pantalla de tela ·  
 metallo, paralume in tessuto · metal, abajur textil · metalli, kangas varjostin ·  
 metal, Klosz z materiału



31 | Weiß matt · white mat



78 | betonfarbig · concrete look



Pendelleuchte · Pendant  
 Ø 52 cm, ↑ 150 cm  
 excl. 3 x E14, max. 28 W



110600331  
 110600378



Pendelleuchte · Pendant  
 Ø 70 cm, ↑ 150 cm  
 excl. 5 x E14, max. 28 W



110600531  
 110600578



# ELSA

Metall, Acryl · metal, acryl ·  
 metale, acryl · metaal, acryl · metal, acrilico ·  
 metallo, acrilico · metal, acrilic · metalli, akryyli · metal, akryl

Empfohlen:  
 recommended: Filament LED E14, 4 W  
 470 lm, 3.000 K



990-400



31 | Weiß matt · white mat

42 | Anthrazit · anthracite



Krone · Chandelier  
 Ø 56 cm, ↑ 150 cm  
 excl. 5 x E14, max. 40 W



112900531  
 112900542



Krone · Chandelier  
 Ø 72 cm, ↑ 150 cm  
 excl. 9 x E14, max. 40 W



112900931  
 112900942





# ONTARIO

Glas goldfarbig oder kupferfarbig · glass gold or copper · Verre Or ou Cuivre · Glas Goud of Koperkleurig · Vidrio Oro o Color cobre · Vetro Oro o Colore rame · Sticla Aur sau Cupru · Lasi Kultaa tai Kuperinvärinen · Szkło Złota lub Kolorze miedzi



09 | kupferfarbig · copper



79 | goldfarbig · gold

Pendelleuchte · Pendant  
↓ 155 cm, Ø 51 cm  
excl. 1 x E27, max. 60 W



315200109  
315200179



# CONNOR

Metall, schwarz matt · metal, black mat · Métal, Noir mat · Metaal, Mat zwart · Metal, Estera negra · Metallo, Nero opaco · Metal, Negru mat · Metalli, mattamusta · Metal, Czarny mat

Empfohlen:  
recommended: Filament LED E27, 7 W  
806 lm, 3.000 K



988-600

Pendelleuchte · Pendant  
↔ 126 x 40 cm, ↓ 150 cm  
excl. 8 x E27, max. 10 W



306200832





# LUCERNA

Chrom, Acryl · chrome, acryl ·  
 chrome, acryl · chroom, acryl · cromo, acrílico · cromo, acrilico ·  
 crom, acrylic · kromi, akryyli · chrom, akryl



Wandleuchte · Wall lamp  
 ↔ 33 x 22 cm, ↗ 19 cm  
 excl. 2 x E14, max. 40 W



201600206



Lüster · Chandelier  
 Ø 52 cm, ↑ 150 cm  
 excl. 5 x E14, max. 40 W



101600506



Lüster · Chandelier  
 Ø 68,5 cm, ↑ 150 cm  
 excl. 8 x E14, max. 40 W



101600806

Empfohlen:  
 recommended: Filament LED E14, 4 W  
 470 lm, 3.000 K



990-400





# CANDELA

Aluminium gebürstet/Chrom oder Messing matt/Messing poliert · brushed aluminium/chrome or brass mat/polished brass · aluminium balayé/chrome ou laiton mat/laiton polis · geborsteld aluminium/chroom of messing mat/gepolijst messing · aluminio pulido/cromo o bronce mate/bronce · alluminio spazzolato/cromo o ottone satinato/ottone lucido · aluminiumu lucios/crom sau bronz mat/bronz · harjattu alumiini/kromi tai mattamessinki/messinki · aluminium szczotkowane/chrom lub mosiądz mat/mosiądz polerowany

Empfohlen:  
recommended: Filament LED E14, 4 W  
400 lm, 2.700 K



989-479



03 | Messing poliert · polished brass



05 | Aluminium gebürstet · brushed aluminium



Pendelleuchte · Pendant  
Ø 56 cm, ↑ 150 cm  
excl. 4 x E14, max. 40 W



102000403  
102000405

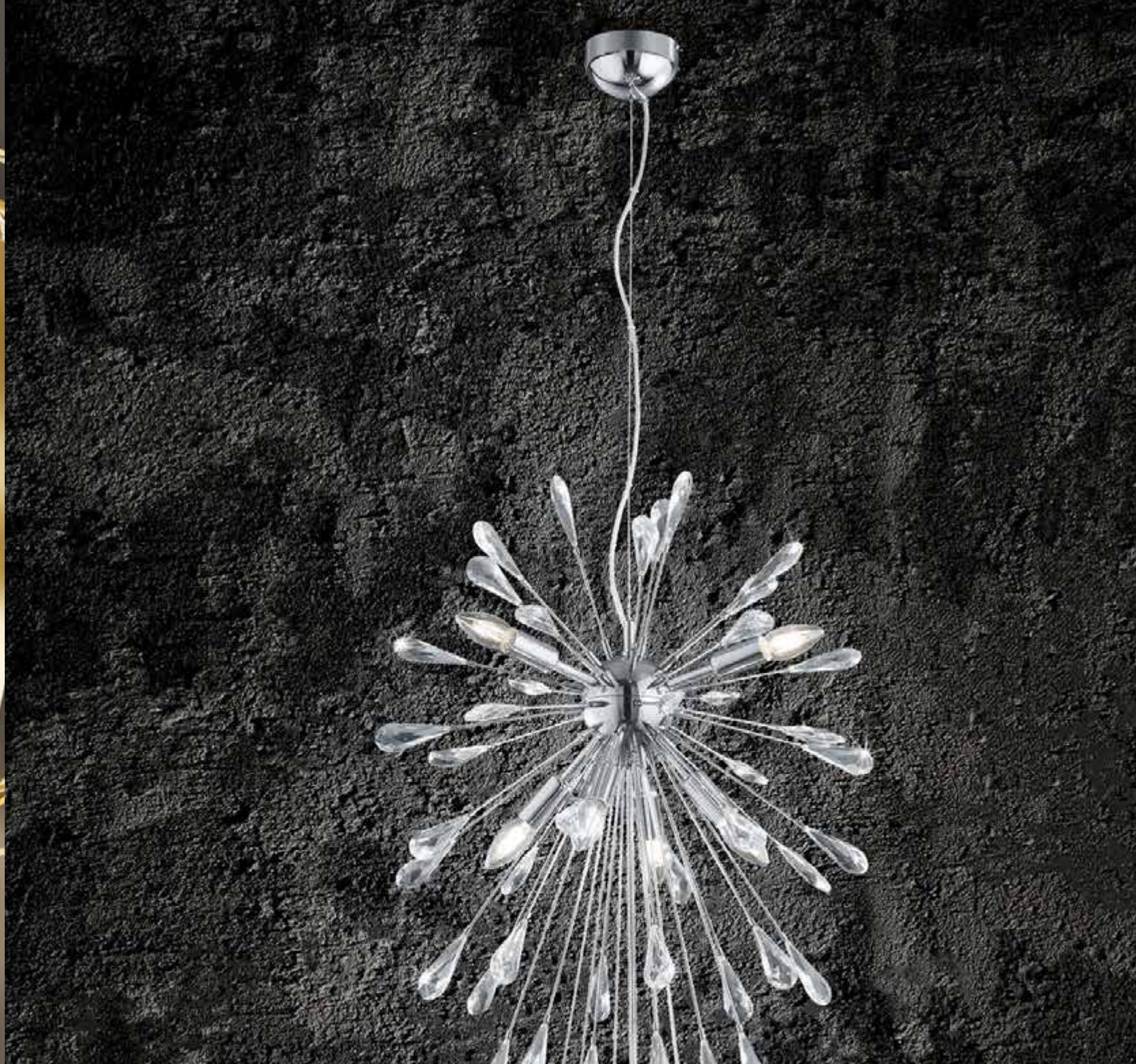

# MINSK

Metall, Acryl · metal, acryl ·  
metale, acryl · metaal, acryl · metal, acrílico ·  
metallo, acrilico · metal, acrylic · metalli, akryyli · metal, akryl

Empfohlen:  
recommended: Filament LED E14, 4 W  
470 lm, 2.700 K



989-400

Pendelleuchte · Pendant  
Ø 50 cm, ↑ max. 150 cm  
excl. 7 x E14, max. 28 W



308600706





# CALAIS

Holz Schwarz, Rauchglas · wood black, smoked glass ·  
 bois noir, verre fumé · hout zwart, rookglas · maderá negro, vidrio ahumado ·  
 di legno nero, vetro fume' · lemn negru, sticla fumurie · puu musta, savulasi ·  
 drewno czarny, szkło przydymione

Empfohlen:  
 recommended: Filament LED E27, 4 W  
 470 lm, 2.700 K



987-400



Pendelleuchte · Pendant  
 ↓ 130 cm, Ø 20 cm  
 excl. 1 x E27, max. 60 W



304800142



# BOOLAN

Holz · wood ·  
 bois · hout · maderá · di legno ·  
 lemn · puu · drewno

Pendelleuchte · Pendant  
 Ø 50 cm, ↑ 150 cm  
 excl. 1 x E27, max. 60 W



305900126  
 305900130

Empfohlen:  
 recommended: Filament LED E27, 7 W  
 806 lm, 3.000 K



988-600



26 | Braun · brown



30 | holzfarbig hell · light colored wood



# HOLLY

Metall, Weiß matt · metal, white mat ·  
metale, blanc mat · metaal, wit mat · metal, estera blanca ·  
metallo, bianco opaco · metal, alb mat · metalli, mattavalkoinen ·  
metal, biały mat



Pendelleuchte · Pendant  
Ø 48 cm, ↑ 150 cm  
excl. 3 x E27, max. 42 W



238 307400331

Empfohlen:  
recommended: LED E27, 4,9 W  
470 lm, 3.000 K



987-60

# ROMINO II

Schwarz matt, Metall · black mat, metal ·  
noir mat, metale · mat zwart, metaal ·  
estera negra, metal · nero opaco, metallo ·  
negru mat, metal · musta matto, metalli ·  
czarny mat, metal



Pendelleuchte · Pendant  
Ø 50 cm, ↑ 150 cm  
excl. 1 x E27, max. 60 W



308000132



# LORELEY

Chrom, Acryl, Stoffschirm · chrome, acryl, fabric shade ·  
chrome, acryl, abat-jour tissu · chroom, acryl, Stoffen kap ·  
cromo, acrílico, Pantalla de tela · cromo, acrílico, paralume in tessuto ·  
crom, acrílic, abajur textil · kromi, akryyli, kangas varjostin ·  
chrom, akryl, Klosz z materiału

Empfohlen:  
recommended: Filament LED E14, 4 W  
470 lm, 2.700 K



989-400



Pendelleuchte · Pendant  
Ø 50 cm, ↑ 150 cm  
excl. 3 x E14, max. 40 W



309300302





# LEVISTO

Nickel matt oder Messing matt, Glas alabasterfarbig · nickel mat or brass mat, alabaster-coloured glass · nickel mat ou laiton mat, verre couleur albâtre · nikkel mat of messing mat, albastkleurig glas · níquel mate o bronze mate, vidrio de color alabastro · nichel opaco o ottone satinato, vetro colore alabastro · nichel mat sau bronz mat, sticla culoare alabastu · harjattu teräs tai mattamessinki, lasi alabasteri väri · nikiel mat lub mosiądz mat, szkło alabaster kolor

incl.  
LED E14, 5 W  
400 lm, 3.000 K



983-60

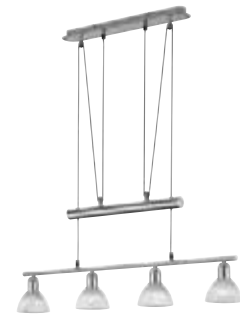
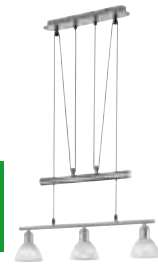

Pendelleuchte · Pendant  
↔ 60,5 cm, ↑ 95 - 160 cm  
incl. 3 x LED E14, 5 W  
3 x 400 lm, 3.000 K

Pendelleuchte · Pendant  
↔ 80 cm, ↑ 95 - 160 cm  
incl. 4 x LED E14, 5 W  
4 x 400 lm, 3.000 K



371010307  
371010308



371010407  
371010408

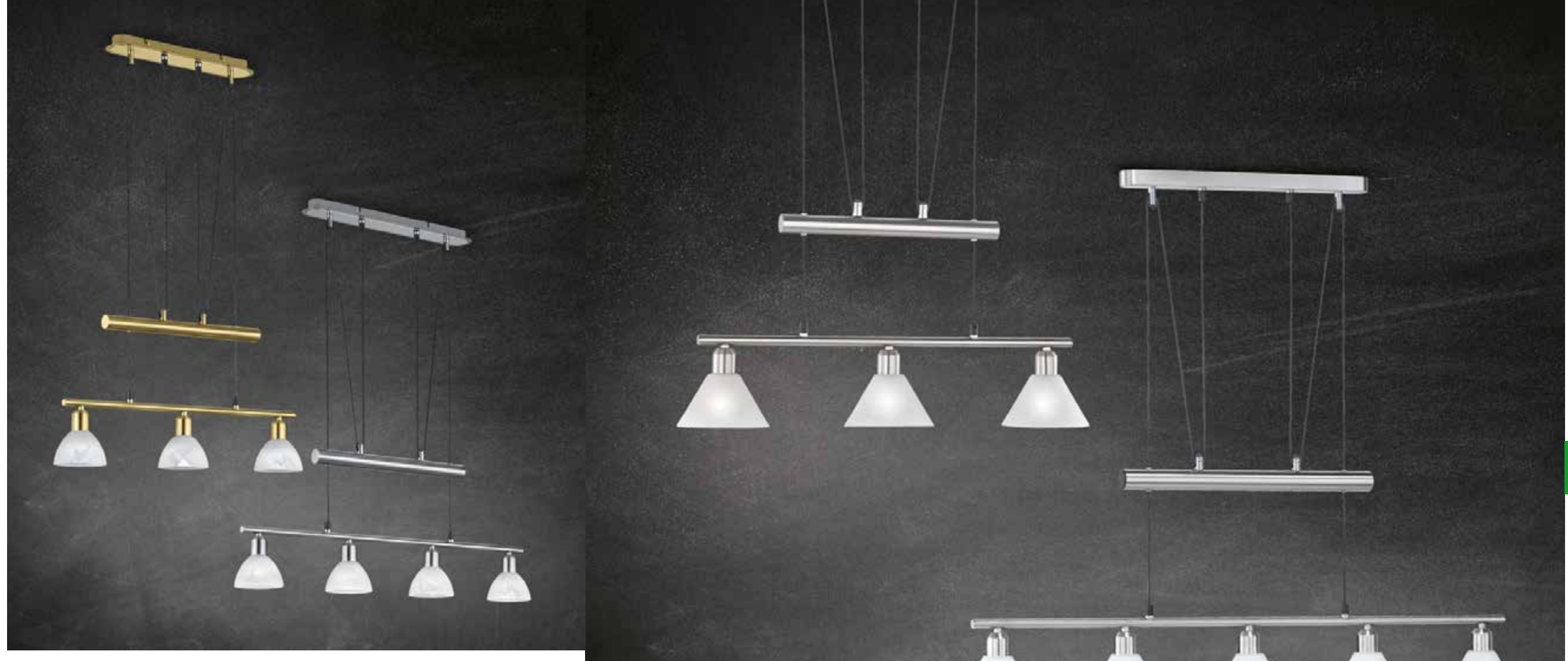

# FREDDY

Nickel matt, Glas matt · nickel mat, mat glass · nickel mat, verre mat · nikkel mat, mat glas · níquel mate, vidrio mate · nichel opaco, vetro sabbaiato · nichel mat, sticla mata · harjattu teräs, mattalasi · nikiel mat, szkło matowane

incl.  
LED E14, 4 W  
320 lm, 3.000 K



983-40

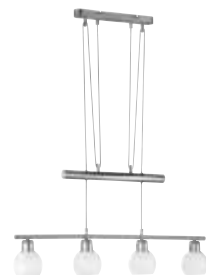

Pendelleuchte · Pendant  
↔ 78 cm, ↑ 85 - 180 cm  
incl. 4 x LED E14, 4 W  
4 x 320 lm, 3.000 K



324810407



# STAMINA

Nickel matt, Glas matt · nickel mat, mat glass · nickel mat, verre mat · nikkel mat, mat glas · níquel mate, vidrio mate · nichel opaco, vetro sabbaiato · nichel mat, sticla mata · harjattu teräs, mattalasi · nikiel mat, szkło matowane

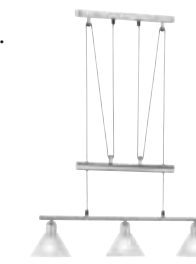

Pendelleuchte · Pendant  
↔ 66 x 14 cm, ↑ 80 - 180 cm  
excl. 3 x E14, max. 40 W



3751031-07

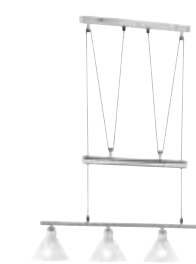

Pendelleuchte · Pendant  
↔ 80 x 14 cm, ↑ 80 - 180 cm  
excl. 4 x E14, max. 40 W



3751041-07



Pendelleuchte · Pendant  
↔ 102 x 14 cm, ↑ 80 - 180 cm  
excl. 5 x E14, max. 40 W



3751051-07





# COLIN

Nickel matt, Glas matt · nickel mat, mat glass ·  
nickel mat, verre mat · nikkel mat, mat glas ·  
níquel mate, vidrio mate · nichel opaco, vetro sabbato ·  
nichel mat, sticla mata · harjattu teräs, mattalasi ·  
nikiel mat, szkło matowane



242

Pendelleuchte · Pendant  
Ø 38,5 cm, ↑ 130 cm  
excl. 1 x E27, max. 60 W



3407011-07

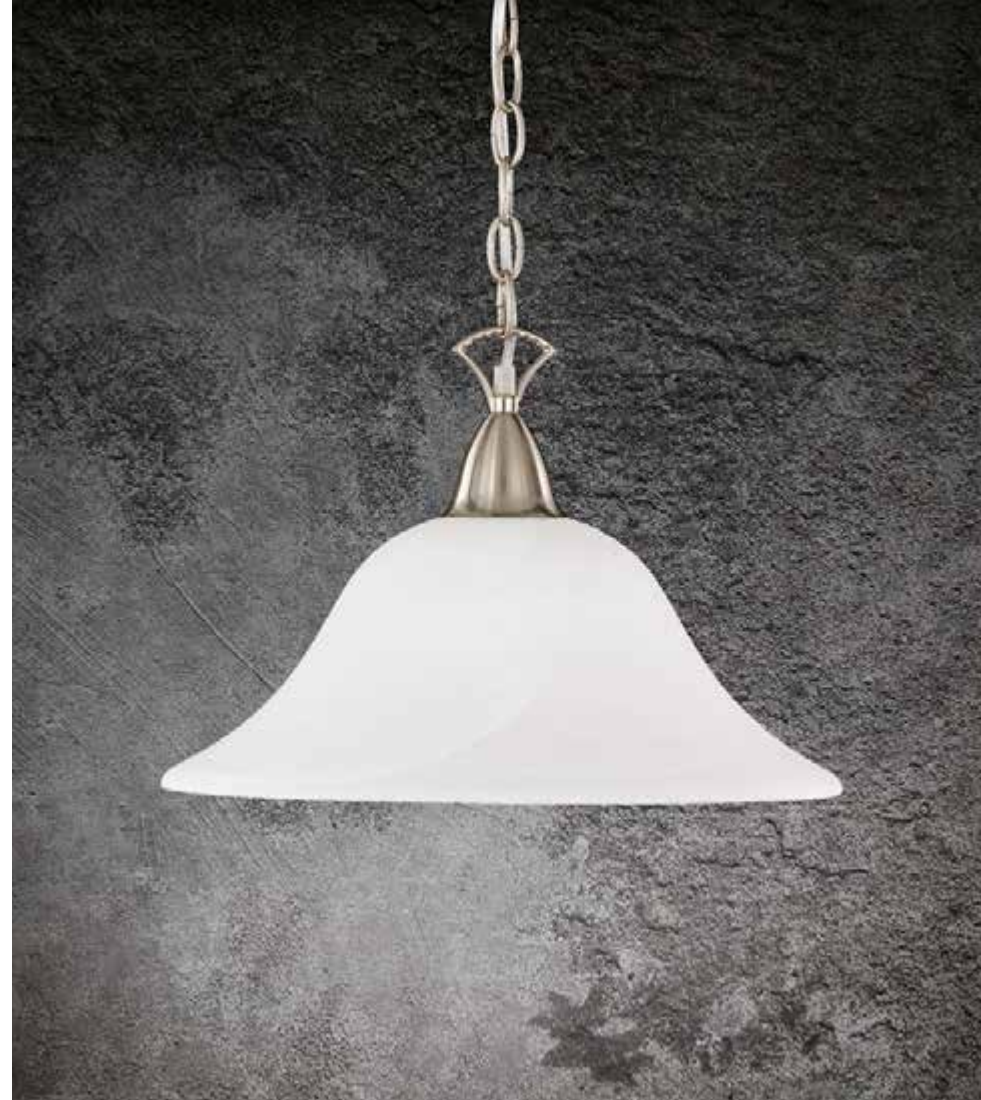

243

# DIEGO

Kunststoff, Weiß, Glas · plastic, white, glass ·  
Plastique, Blanc, Verre · Kunststof, Wit, Glas ·  
Plástico, Blanco, Vidrio · Plastica, Bianco, Vetro ·  
Plastic, Alb, Sticla · Muovi, Valkoinen, Lasi ·  
Plastik, Biały, Szkło



Pendelleuchte · Pendant  
Ø 30 cm, ↑ 125 cm  
excl. 1 x E27, max. 60 W



301400101



# VIOLA

Glas alabasterfarbig · alabaster-coloured glass ·  
verre couleur albâtre · albastkleurig glas · vidrio de color alabastro ·  
vetro colore alabastro · sticla culoare alabastru · lasi alabasteri väri ·  
szkło alabaster kolor



Pendelleuchte · Pendant  
Ø 38,5 cm, ↑ 70 - 130 cm  
excl. 1 x E27, max. 60 W



301700107 | Nickel matt · nickel mat  
301700108 | Messing matt · brass mat



# BAJO

Metall weiß · metal white ·  
metale blanc · metaal wit · metal blanco · metallo bianco ·  
metal alb · metalli valkoinen · metal biały

Pendelleuchte · Pendant

Ø 32,5 cm, ↑ 150 cm  
excl. 1 x E27, max. 40 W



307290101



# ZUCCA

Chrom, Acryl · chrome, acryl ·  
chrome, acryl · chroom, acryl · cromo, acrílico ·  
cromo, acrílico · crom, acrílic · kromi, akryyli · chrom, akryl



00 | Transparent · transparent



06 | Chrom · chrome

Pendelleuchte · Pendant

Ø 40 cm, ↑ 150 cm  
excl. 1 x E27, max. 60 W



304100100  
304100106



# PAPER

Papier, Weiß · paper, white ·  
papier, blanc · papier, wit · papel, blanco ·  
carta, bianco · hartie, alb · paperi, valkoinen · papier, biały



↑ 73,5 cm  
excl. 1 x E27, max. 60 W  
VE / moq: 25



3590010-01



Pendelleuchte · Pendant  
Ø 40 cm  
excl. 1 x E27, max. 60 W  
VE / moq: 25



3490400-00



Pendelleuchte · Pendant  
Ø 40 cm, ↑ 47 cm  
excl. 1 x E27, max. 60 W  
VE / moq: 25



3491400-00





## Leuchten im Vintage Stil

- Vintage style luminaires
- Luminaire style Vintage
- Armaturen in Vintage stijl
- Lámparas vintage
- Apparecchi stile vintage
- Corpuri de iluminat vintage
- Vintage valaisimet
- Lampy w stylu vintage



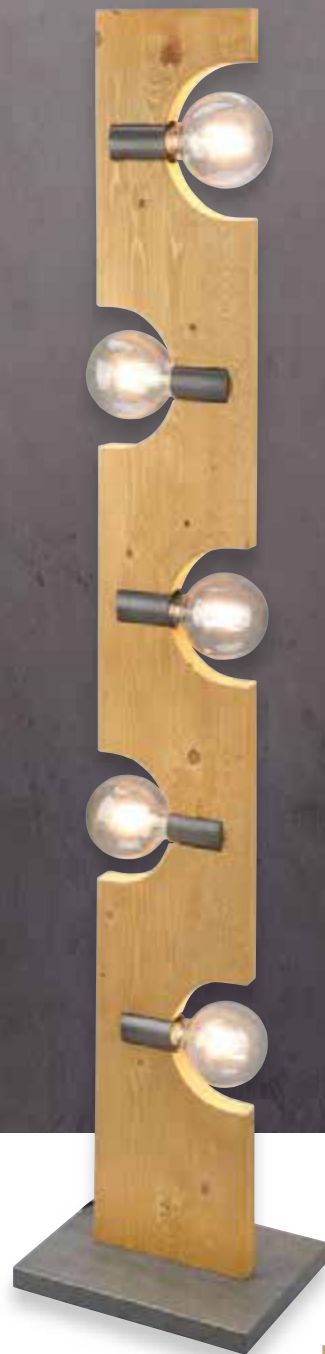
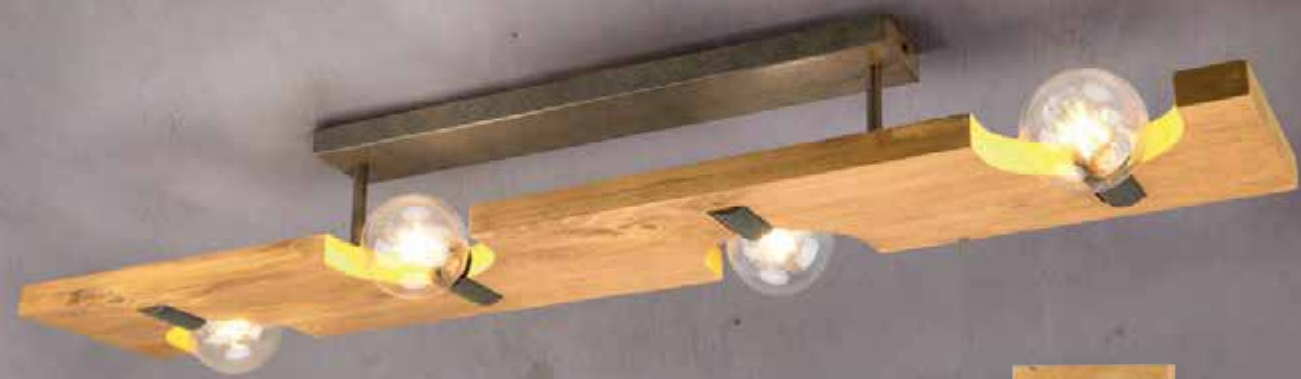

# TAILOR

Metall, Nickel antik, Holz · metal, nickel antique, wood ·  
metale, nickel antique, bois · metaal, antiek nikkel, hout · metal, níquel antiguo, madera ·  
metallo, nickel anticato, di legno · metal, nichel antic, lemn · metalli, antiikkiteräs, puu ·  
metal, aikiel antyczny, drewno



Deckenleuchte · Ceiling lamp  
↔ 115 x 20 cm, ↑ 15,7 cm  
excl. 4 x E27, max. 40 W



614300430



Pendelleuchte · Pendant  
↔ 115 x 20 cm, ↑ 150 cm  
excl. 4 x E27, max. 40 W



314300430



Tischleuchte · Table lamp  
↑ 52,5 cm, ↔ 22 x 15 cm  
excl. 2 x E27, max. 40 W



514300230



Stehleuchte · Floor lamp  
↑ 142,5 cm, ↔ 30 x 22 cm  
excl. 5 x E27, max. 40 W



414300530







# BRADLEY

Holz · wood · bois · hout · madera · di legno · lemn · puu · drewno



Empfohlen:  
recommended: Filament LED E27, 6 W  
600 lm, 2.700 K



987-679

Wandleuchte · Wall lamp  
↓ 16 x 10,5 cm, ↗ 10,5 cm  
excl. 2 x E27, max. 10 W



203000230



# BRAD

Nickel antik, Holz · nickel antique, wood · nickel antique, bois · antiek nikkel, hout · níquel antiguo, madera · nickel anticato, di legno · nichel antic, lemn · antiikkiteräs, puu · aikiel antyczny, drewno · antik nikel, tahta

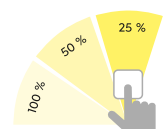

SWITCH DIMMER



Wandleuchte · Wall lamp  
↓ 11 x 11 cm, ↗ 11 cm  
incl. OSRAM-LED, 4,3 W  
430 lm, 3.000 K



223710130



Wandleuchte · Wall lamp  
↓ 11 x 37 cm, ↗ 11 cm  
incl. SMD-LED, 13,5 W  
1.500 lm, 3.000 K



223790130



Deckenleuchte · Ceiling lamp  
↔ 100 x 20 cm, ↓ 16,7 cm  
incl. SMD-LED, 27 W  
3.400 lm, 3.000 K



623710130



Pendelleuchte · Pendant  
↔ 100 x 20 cm, ↓ 150 cm  
incl. SMD-LED, 27 W  
3.400 lm, 3.000 K



323710130



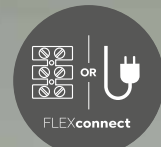

Seite/page 632



Deckenleuchte · Ceiling lamp  
↔ 40 x 40 cm, ↓ 20 cm  
excl. 4 x E27, max. 28 W



605500467

Wandleuchte · Wall lamp  
↓ 20 cm, ↔ 15 cm, ↗ 11 cm  
excl. 1 x E27, max. 28 W



205570167

Wandleuchte · Wall lamp  
↓ 20 cm, ↔ 35 cm, ↗ 11 cm  
excl. 2 x E27, max. 28 W



205570267

# KHAN

Nickel antik, Holz · nickel antique, wood ·  
nickel antique, bois · antiek nikkel, hout · níquel antiguo, madera ·  
nickel anticato, di legno · nichel antic, lemn · antiikkiteräs, puu ·  
aikiel antyczny, drewno · antik nikel, tahta

Empfohlen:  
recommended: Filament LED E27, 6 W  
600 lm, 2.700 K



987-679



Stehleuchte · Floor lamp  
↓ 153 cm, ↔ 25 x 25 cm  
excl. 3 x E27, max. 10 W



405500367



Pendelleuchte · Pendant  
↔ 100 x 15 cm, ↓ 150 cm  
excl. 4 x E27, max. 28 W



305500467





Pendelleuchte · Pendant  
↔ 107,5 cm, ↓ max. 215 cm, Ø 25,5 cm  
excl. 3 x E27, max. 42 W



303400367



Stehleuchte · Floor lamp  
↓ 150 cm, Ø 25,5 cm, ∠ 21,5 cm  
excl. 1 x E27, max. 42 W



403490167



## DELHI

Metall, Nickel antik, Holz · metal, nickel antique, wood ·  
metale, nickel antique, bois · metaal, antiek nikkel, hout · metal, níquel antiguo, madera ·  
metallo, nickel anticato, di legno · metal, nichel antic, lemn · metalli, antiikkiteräs, puu ·  
metal, aikiel antyczny, drewno

Empfohlen:  
recommended: Filament LED E27, 4 W  
470 lm, 2.700 K



987-400



Pendelleuchte · Pendant  
Ø 45 cm, ↓ 150 cm  
excl. 1 x E27, max. 60 W



303400167





## DELHI

Metall, Nickel antik, Holz · metal, nickel antique, wood ·  
 metale, nickel antique, bois · metaal, antiek nikkel, hout · metal, níquel antiguo, madera ·  
 metallo, nickel anticato, di legno · metal, nichel antic, lemn · metalli, antiikkiteräs, puu ·  
 metal, aikiel antycznz, drewno



Deckenleuchte · Ceiling lamp  
 Ø 11,6 cm, ↗ 20,5 cm  
 excl. 1 x E14, max. 40 W



803400167



Deckenleuchte · Ceiling lamp  
 ↔ 33 x 11,6 cm, ↑ 20,5 cm  
 excl. 2 x E14, max. 40 W



803400267



Deckenleuchte · Ceiling lamp  
 ↔ 58 x 11,6 cm, ↑ 20,5 cm  
 excl. 3 x E14, max. 40 W



803400367



Stehleuchte · Floor lamp  
 ↑ 158 cm, ↔ 66 cm, Ø 40 cm  
 excl. 1 x E27, max. 60 W



403400167







Wandleuchte · Wall lamp  
↓ 32 cm, ↔ 15 cm, ↗ 25,6 cm  
excl. 1 x E14, max. 10 W



209500167



Pendelleuchte · Pendant  
Ø 35 cm, ↓ 150 cm  
excl. 1 x E27, max. 28 W



309500167

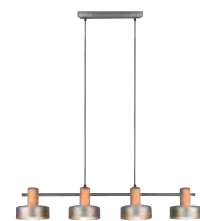

Pendelleuchte · Pendant  
↔ 90 x 15 cm, ↓ 150 cm  
excl. 4 x E14, max. 28 W



309500467



Stehleuchte · Floor lamp  
↓ 152 cm, ↗ 77 cm, Ø 35/25 cm  
excl. 1 x E27, max. 10 W



409500167

# GAYA

Metall, Nickel antik, Holz · metal, nickel antique, wood ·  
metale, nickel antique, bois · metaal, antiek nikkel, hout · metal, níquel antiguo, madera ·  
metallo, nickel anticato, di legno · metal, nichel antic, lemn · metalli, antiikkiteräs, puu ·  
metal, aikiel antyczny, drewno · metal, antik nikel, tahta

Empfohlen:  
recommended: Filament LED E27, 4 W  
470 lm, 2.700 K



987-400



Filament LED E14, 4 W  
470 lm, 3.000 K

983-400

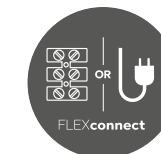





Deckenleuchte · Ceiling lamp  
↔ 42,5 x 14,5 cm, ↑ 23,2 cm  
excl. 2 x E14, max. 25 W



801900267



Deckenleuchte · Ceiling lamp  
↔ 58 x 10 cm, ↑ 23 cm  
excl. 3 x E14, max. 25 W



801900367



Wandleuchte · Wall lamp  
↔ 11 x 11 cm, ↑ 23,2 cm  
excl. 1 x E14, max. 25 W



801900167



Deckenleuchte · Ceiling lamp  
↔ 39 x 39 cm, ↑ 19,8 cm  
excl. 4 x E14, max. 25 W



601900467



Stehleuchte · Floor lamp  
↑ 150 cm, ↔ 25 x 25 cm  
excl. 3 x E14, max. 25 W



401900367



## BELL

Metall, Nickel antik, innen goldfarbig, Holz · metal, nickel antique, gold colored inside, wood ·  
metale, nickel antique, Or, bois · metaal, antiek nikkel, Binnenkant goudkleur, hout ·  
metal, níquel antiguo, Interior en color dorado, madera · metallo, nickel anticato,  
interno colore oro, di legno · metal, nichel antic, interior culoare aurie, lemn ·  
metalli, antiikkiteräs, sisäosa kullanvärinen, puu · metal, aikiel antyczny, wewnątrz złoty, drewno

Empfohlen:  
recommended: Filament LED E14, 4 W  
470 lm, 3.000 K



983-400



Pendelleuchte · Pendant  
↔ 100 x 21 cm, ↑ 150 cm  
excl. 4 x E14, max. 25 W



301900467





# HARRIS

Metall, Schwarz matt, innen goldfarbig, Holz · metal, black mat, gold colored inside, wood ·  
metale, noir mat, Or, bois · metaal, mat zwart, Binnenkant goudkleur, hout ·  
metal, estera negra, Interior en color dorado, madera · metallo, nero opaco, interno colore oro, di legno ·  
metal, negru mat, interior culoare aurie, lemn · metalli, mattamusta, sisäosa kullanvärinen, puu ·  
metal, czarny mat, wewnątrz złoty, drewno

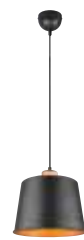

Pendelleuchte · Pendant  
↑ 150 cm, Ø 26 cm  
excl. 1 x E27, max. 60 W



312700132



Pendelleuchte · Pendant  
↑ 150 cm, ↔ 87 cm, Ø 18 cm  
excl. 4 x E27, max. 40 W



312700432



Stehleuchte · Floor lamp  
↑ 156 cm, ↗ 75 cm, Ø 26 cm  
excl. 1 x E27, max. 60 W



412700132







## RODRIGO

Metall, Nickel antik, innen goldfarbig, Holz · metal, nickel antique, gold colored inside, wood ·  
 metale, nickel antique, Or, bois · metaal, antiek nikkel, Binnenkant goudkleur, hout ·  
 metal, níquel antiguo, Interior en color dorado, madera · metallo, nickel anticato, interno colore oro, di legno ·  
 metal, nichel antic, interior culoare aurie, lemn · metalli, antiikkiteräs, sisäosa kullanvärinen, puu ·  
 metal, aikiel antyczny, wewnątrz złoty, drewno



Stehleuchte · Floor lamp  
 ↓ 165 cm, ↔ 26 cm, ↗ 41 cm  
 excl. 1 x E27, max. 60 W



402690167



## HENLEY

Metall, Schwarz matt, Holz · metal, black mat, wood ·  
 metale, noir mat, bois · metaal, mat zwart, hout · metal, estera negra, madera ·  
 metallo, nero opaco, di legno · metal, negru mat, lemn · metalli, mattamusta, puu ·  
 metal, czarny mat, drewno



Pendelleuchte · Pendant  
 Ø 40 cm, ↑ 150 cm  
 excl. 3 x E14, max. 40 W



310730332



Pendelleuchte · Pendant  
 ↔ 115 x 18 cm, ↑ 150 cm  
 excl. 4 x E14, max. 40 W



310700432



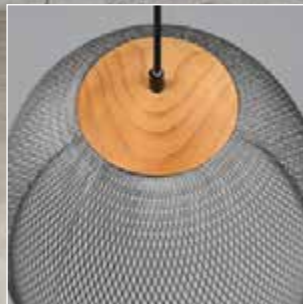

# IVAR

Metall, Nickel antik, Holz · metal, nickel antique, wood ·  
 metale, nickel antique, bois · metaal, antiek nikkel, hout ·  
 metal, níquel antiguo, madera · metallo, níquel anticato, di legno · metal, nichel antic, lemn ·  
 metalli, antiikkiteräs, puu · metal, aikiel antyczny, drewno

Empfohlen:  
 recommended: Filament LED E27, 6 W  
 660 lm, 2.700 K



988-679



Pendelleuchte · Pendant  
 Ø 25 cm, ↑ 150 cm  
 excl. 1 x E27, max. 40 W



309000167



Pendelleuchte · Pendant  
 Ø 40 cm, ↑ 150 cm  
 excl. 1 x E27, max. 40 W



309090167



Stehleuchte · Floor lamp  
 ↑ 150 - 186 cm, Ø 69 cm  
 excl. 1 x E27, max. 40 W



409000167





Empfohlen:  
recommended: Filament LED E27, 8 W  
806 lm, 2.700 K



987-6810

# MADRAS

silberfarbig antik, Holz · antique silver, wood ·  
argent antique, bois · antiek zilver, hout · plateado antiguo, madera · argento anticato, di legno ·  
argint antic, lemn · antiikkiihopea, puu · antyczne srebro, drewno · gümüş antika, tahta



Wandleuchte · Wall lamp  
↑ 23 x 14 cm, ↗ 14 x 17 cm  
excl. 1 x E27, max. 28 W



805300188



Deckenleuchte · Ceiling lamp  
↔ 30 x 14 cm, ↓ 28 cm  
excl. 2 x E27, max. 28 W



805300288



Deckenleuchte · Ceiling lamp  
↔ 60,5 x 14 cm, ↓ 28 cm  
excl. 3 x E27, max. 28 W



805300388



Deckenleuchte · Ceiling lamp  
↔ 80 x 14 cm, ↓ 28 cm  
excl. 4 x E27, max. 28 W



805300488



Pendelleuchte · Pendant  
↔ 90 x 14 cm, ↓ 150 cm  
excl. 4 x E27, max. 28 W



305300488







# FORESTER

Metall, Nickel antik, Holz · metal, nickel antique, wood ·  
 metale, nickel antique, bois · metaal, antiek nikkel, hout · metal, níquel antiguo, madera ·  
 metallo, nickel anticato, di legno · metal, nichel antic, lemn · metalli, antiikkiteräs, puu ·  
 metal, aikiel antyczny, drewno

Empfohlen:  
 recommended: Filament LED E27, 4 W  
 470 lm, 2.700 K



987-400



Pendelleuchte · Pendant  
 ↔ 100 x 10 cm, ↑ 200 cm  
 excl. 5 x E27, max. 42 W



308100567



# PLANT

Nickel antik, Sisal · nickel antique, Sisal ·  
 nickel antique, Sisal · antiek nikkel, Sisal ·  
 níquel antiguo, Sisal · nickel anticato, Sisal ·  
 nichel antic, Sisal · antiikkiteräs, Sisal ·  
 aikiel antyczny, Sisal

Deko-Pflanze nicht enthalten! · Decoration not included! ·  
 Décoration non incluse! · Decoratie niet inbegrepen! ·  
 Decoración no incluida. · Decorazione non inclusa! ·  
 Decorația nu este inclusă! · Koristus ei sisälly! ·  
 Nie zawiera dekoracji!

Empfohlen:  
 recommended: Filament LED E27, 4 W  
 470 lm, 2.700 K



987-400



92945



Pendelleuchte · Pendant  
 ↔ 115 x 22 cm, ↑ 150 cm  
 excl. 3 x E27, max. 40 W



301000367





# AGRA

Metall, Schwarz matt, Holz · metal, black mat, wood ·  
 metale, noir mat, bois · metaal, mat zwart, hout · metal, estera negra, madera ·  
 metallo, nero opaco, di legno · metal, negru mat, lemn · metalli, mattamusta, puu ·  
 metal, czarny mat, drewno

Empfohlen:  
 recommended: Filament LED E27, 4 W  
 470 lm, 2.700 K



987-400

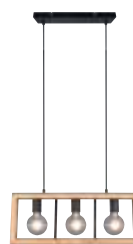

Pendelleuchte · Pendant  
 ↔ 60 x 8,5 cm, ↓ 150 cm  
 excl. 3 x E27, max. 10 W



313800332



Pendelleuchte · Pendant  
 ↔ 100 x 8,5 cm, ↓ 150 cm  
 excl. 5 x E27, max. 10 W



313800532



# TENALI

Metall, Schwarz matt, Holz · metal, black mat, wood ·  
 metale, noir mat, bois · metaal, mat zwart, hout · metal, estera negra, madera ·  
 metallo, nero opaco, di legno · metal, negru mat, lemn · metalli, mattamusta, puu ·  
 metal, czarny mat, drewno



Deckenleuchte · Ceiling lamp  
 ↔ 100 x 20 cm, ↓ 32,6 cm  
 excl. 4 x E27, max. 40 W



616500432



Pendelleuchte · Pendant  
 ↓ 150 cm, ↔ 100 x 20 cm  
 excl. 4 x E27, max. 40 W



316500432

Empfohlen:  
 recommended: Filament LED E27, 6 W  
 600 lm, 2.700 K



987-679





## TOSH

Metall, Schwarz matt, Holz · metal, black mat, wood ·  
 metale, noir mat, bois · metaal, mat zwart, hout · metal, estera negra, madera ·  
 metallo, nero opaco, di legno · metal, negru mat, lemn · metalli, mattamusta, puu ·  
 metal, czarny mat, drewno



Wandleuchte · Wall lamp  
 ↔ 9 x 13,7 cm, ↗ 19,5 cm  
 excl. 1 x E14, max. 15 W



804370132



Deckenleuchte · Ceiling lamp  
 ↔ 26 x 9 cm, ↓ 19,5 cm  
 excl. 2 x E14, max. 15 W



804370232



Deckenleuchte · Ceiling lamp  
 ↔ 44 x 9 cm, ↓ 19,5 cm  
 excl. 3 x E14, max. 40 W



804300332



Deckenleuchte · Ceiling lamp  
 ↔ 22 x 22 cm, ↓ 19,5 cm  
 excl. 4 x E14, max. 40 W



804300432



Pendelleuchte · Pendant  
 ↔ 65 x 9 cm, ↑ 150 cm  
 excl. 4 x E27, max. 40 W



304300432

Empfohlen:  
 recommended: Filament LED E14,  
 4 W,  
 470 lm, 3.000 K



983-400



Pendelleuchte · Pendant  
 Ø 10 cm, ↑ 150 cm  
 excl. 1 x E27, max. 40 W



304300132



Pendelleuchte · Pendant  
 Ø 28 cm, ↑ 150 cm  
 excl. 3 x E27, max. 40 W



304330332



Stehleuchte · Floor lamp  
 ↑ 150 cm, Ø 23 cm  
 excl. 3 x E14, max. 15 W



404300332



Tischleuchte · Table lamp  
 ↑ 40 cm, ↔ 15 x 18 cm  
 excl. 1 x E14, max. 15 W



504300132





## KORBA

Holz, Stoffschirm · wood, fabric shade ·  
 bois, abat-jour tissu · hout, Stoffen kap ·  
 madera, Pantalla de tela · di legno, paralume in tessuto ·  
 lemn, abajur textil · puu, kangas varjostin ·  
 drewno, Klosz z materiału · tahta, Kumaş şapka



Deckenleuchte · Ceiling lamp  
 Ø 40 cm, ↑ 37 cm  
 excl. 1 x E27, max. 60 W



601200101



Pendelleuchte · Pendant  
 ↑ 150 cm, Ø 40 cm  
 excl. 1 x E27, max. 60 W



301200101



Tischleuchte · Table lamp  
 ↑ 34 cm, Ø 20 cm  
 excl. 1 x E27, max. 60 W



501200101



Pendelleuchte · Pendant  
 ↑ 150 x 40 cm, ↔ 105 cm  
 excl. 2 x E27, max. 60 W



301200201



Stehleuchte · Floor lamp  
 ↑ 162 cm, Ø 40 cm  
 excl. 1 x E27, max. 60 W



401200101





# ELMAU

Holz, Stoffschirm · wood, fabric shade ·  
 bois, abat-jour tissu · hout, Stoffen kap · maderas, Pantalla de tela ·  
 di legno, paralume in tessuto · lemn, abajur textil · puu, kangas varjostin · drewno, Klosz z materiału



Deckenleuchte · Ceiling lamp  
 Ø 35 cm, ↑ 36,5 cm  
 excl. 1 x E27, max. 60 W



602100130

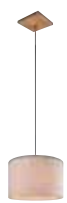

Pendelleuchte · Pendant  
 Ø 35 cm, ↑ 150 cm  
 excl. 1 x E27, max. 60 W



302100130



Pendelleuchte · Pendant  
 ↔ 100 x 20 cm, ↑ 150 cm  
 excl. 4 x E27, max. 60 W



302100430



Tischleuchte · Table lamp  
 ↑ 40 cm, Ø 18 cm  
 excl. 1 x E14, max. 40 W



502100130







## INGA

Rattangeflecht, Metall, Schwarz matt · rattan meshwork, metal, black mat ·  
 maillage rotin, métal, noir mat · rotan vlechtwerk, metaal, mat zwart · malla de Rattan, metal, estera negra ·  
 reticolo rattan, metallo, nero opaco · impletitura ratan, metal, negru mat · rottinki, metalli, mattamusta · rattan, metal, czarny mat



Deckenleuchte · Ceiling lamp  
 Ø 50 cm, ↑ 30 cm  
 excl. 3 x E27, max. 40 W



612200336



Pendelleuchte · Pendant  
 Ø 29 cm, ↑ 150 cm  
 excl. 1 x E27, max. 40 W



312200136



Pendelleuchte · Pendant  
 Ø 50 cm, ↑ 150 cm  
 excl. 3 x E27, max. 40 W



312200336



Tischleuchte · Table lamp  
 ↑ 30 cm, Ø 16,5 cm  
 excl. 1 x E27, max. 40 W



512200136





# COLINO

Metall, Holz · metal, wood ·  
 metale, bois · metaal, hout · metal, maderas · metallo, di legno ·  
 metal, lemn · metalli, puu · metal, drewno · metal, tahta

Empfohlen:  
 recommended: Filament LED E27, 4 W  
 470 lm, 2.700 K



987-400



32 | Schwarz matt · black mat



42 | naturbelassen · natural finish



Deckenleuchte · Ceiling lamp  
 Ø 40 cm, ↑ 26 cm  
 excl. 2 x E27, max. 40 W



615900232  
 615900242



Pendelleuchte · Pendant  
 Ø 40 cm, ↑ 150 cm,  
 excl. 1 x E27, max. 40 W



315900132  
 315900142





## HEDDA

Metall, Schwarz matt, Sisal · metal, black mat, Sisal ·  
metale, noir mat, Sisal · metaal, mat zwart, Sisal · metal, estera negra, Sisal ·  
metallo, nero opaco, Sisal · metal, negru mat, Sisal · metalli, mattamusta, Sisal ·  
metal, czarny mat, Sisal

Empfohlen:  
recommended: Filament LED E27, 4 W  
470 lm, 2.700 K



987-400



Deckenleuchte · Ceiling lamp  
Ø 52 cm, ↑ 28 cm  
excl. 2 x E27, max. 40 W



612300236



Pendelleuchte · Pendant  
Ø 52 cm, ↑ 150 cm  
excl. 1 x E27, max. 40 W



312300136



## RUNA

Metall, Schwarz matt, Sisal · metal, black mat, Sisal ·  
metale, noir mat, Sisal · metaal, mat zwart, Sisal · metal, estera negra, Sisal · metallo, nero opaco, Sisal ·  
metal, negru mat, Sisal · metalli, mattamusta, Sisal · metal, czarny mat, Sisal



Deckenleuchte · Ceiling lamp  
↑ 27,5 cm, ↔ 23 cm, ↗ 15 cm  
excl. 1 x E27, max. 40 W



203000132



Pendelleuchte · Pendant  
Ø 25 cm, ↑ 150 cm  
excl. 1 x E27, max. 40 W



303000132



Pendelleuchte · Pendant  
Ø 35 cm, ↑ 150 cm  
excl. 1 x E27, max. 40 W



303090132



Stehleuchte · Floor lamp  
↑ 150 cm, Ø 35 cm  
excl. 1 x E27, max. 40 W



403000132



# JUDITH

Glas klar · clear glass ·  
verre claire · helder glas ·  
vidrio claro · vetro chiaro ·  
sticla transparentă · kirkas lasi ·  
przezroczyste szkło



Pendelleuchte · Pendant

Ø 24,5 cm, ↑ 150 cm  
excl. 1 x E27, max. 60 W



302900102

Empfohlen:  
recommended: Filament LED E27, 6 W  
420 lm, 2.700 K



987-679



# RO TIN

Rattangeflecht, Grau antik · rattan meshwork, antique grey ·  
maillage rotin, gris ancien · rotan vlechtwerk, antiek grijs ·  
malla de rattan, gris antiguo · reticolo rattan, grigio antico ·  
impletitura ratan, antic gri · rottinki, antiikki harmaa ·  
rattan, starodawny szary



Pendelleuchte · Pendant

Ø 39 cm, ↑ 150 cm  
excl. 1 x E27, max. 42 W



310900111

Empfohlen:  
recommended: Filament LED E27, 7 W  
806 lm, 3.000 K



988-600



# ROPE

Metall, Altmessing · metal, old brass ·  
metale, laiton fumé · metaal, oud brons · metal, bronce viejo ·  
metallo, ottone invecchiato · metal, bronz antic ·  
metalli, antiikkimessinki · metal, patyna

Empfohlen:  
recommended: Filament LED E27, 7 W  
806 lm, 3.000 K



988-600

Filament LED E27, 6 W  
660 lm, 2.700 K



988-679



Pendelleuchte · Pendant  
Ø 12 cm, ↑ 150 cm  
excl. 1 x E27, max. 60 W



310100104



Pendelleuchte · Pendant  
Ø 12 cm, ↑ 150 cm  
excl. 2 x E27, max. 60 W



310100204







# GOTHAM

Metall, Silber antik · metal, antique silver ·  
 metale, argent antique · metaal, antiek zilver · metal, plateado antiguo ·  
 metallo, argento anticato · metal, argint antic · metalli, antiikkihopea ·  
 metal, antyczne srebro

Empfohlen:  
 recommended: Filament LED E27, 6 W  
 600 lm, 2.700 K



987-679



Wandleuchte · Wall lamp  
 ↑ 46,5 x 14,6 cm, ∅ 17,3 cm  
 excl. 1x E27, max. 60 W



207000188



Pendelleuchte · Pendant  
 ↓ 150 cm, Ø 14,6 cm  
 excl. 1 x E27, max. 60 W



307000188



Pendelleuchte · Pendant  
 ↔ 102 x 46 cm, ↓ 150 cm  
 excl. 6 x E27, max. 60 W



307000688







# TANJA

Metall, Schwarz · metal, black ·  
 metale, noir · metaal, zwart · metal, negro ·  
 metallo, nero · metal, negro · metalli, musta · metal, czarny



Pendelleuchte · Pendant  
 Ø 39 cm, ↑ 150 cm  
 excl. 1 x E27, max. 60 W



300700102

Empfohlen:  
 recommended: Filament LED E27, 7 W  
 806 lm, 3.000 K



988-600

# SANNA

Metall · metal ·  
 metale · metaal · metal · metallo · metal · metalli · metal



Pendelleuchte · Pendant  
 Ø 25 cm, ↑ 150 cm  
 excl. 1 x E27, max. 60 W



300900101  
 300900102

01 | Weiß · white

02 | Schwarz · black



Empfohlen:  
 recommended: Filament-LED E27, 4 W  
 470 lm, 2.700 K



987-400

# JOHANN

Metall, Grau antik oder Kupfer antik · metal, antique grey or antique copper ·  
 metale, gris ancien ou cuivre ancien · metaal, antiek grijs of antiek koper · metal, gris antiguo o cobre antiguo ·  
 metallo, grigio antico o rame antico · metal, antic gri sau cupru antic ·  
 metalli, antiikki harmaa tai antiikki kupari · metal, starodawny szary lub antyczne miedzi



32 | Schwarz matt · black mat



61 | Grau antik · antique grey



62 | Kupfer antik · antique copper



Deckenleuchte · Ceiling lamp  
 Ø 30 cm, ↑ 18 cm  
 excl. 1 x E27, max. 60 W



606903032  
 606903062



Deckenleuchte · Ceiling lamp  
 Ø 40 cm, ↑ 17 cm  
 excl. 1 x E27, max. 60 W



606900132  
 606900161  
 606900162



Deckenleuchte · Ceiling lamp  
 Ø 50 cm, ↑ 18 cm  
 excl. 1 x E27, max. 60 W



606905032  
 606905062



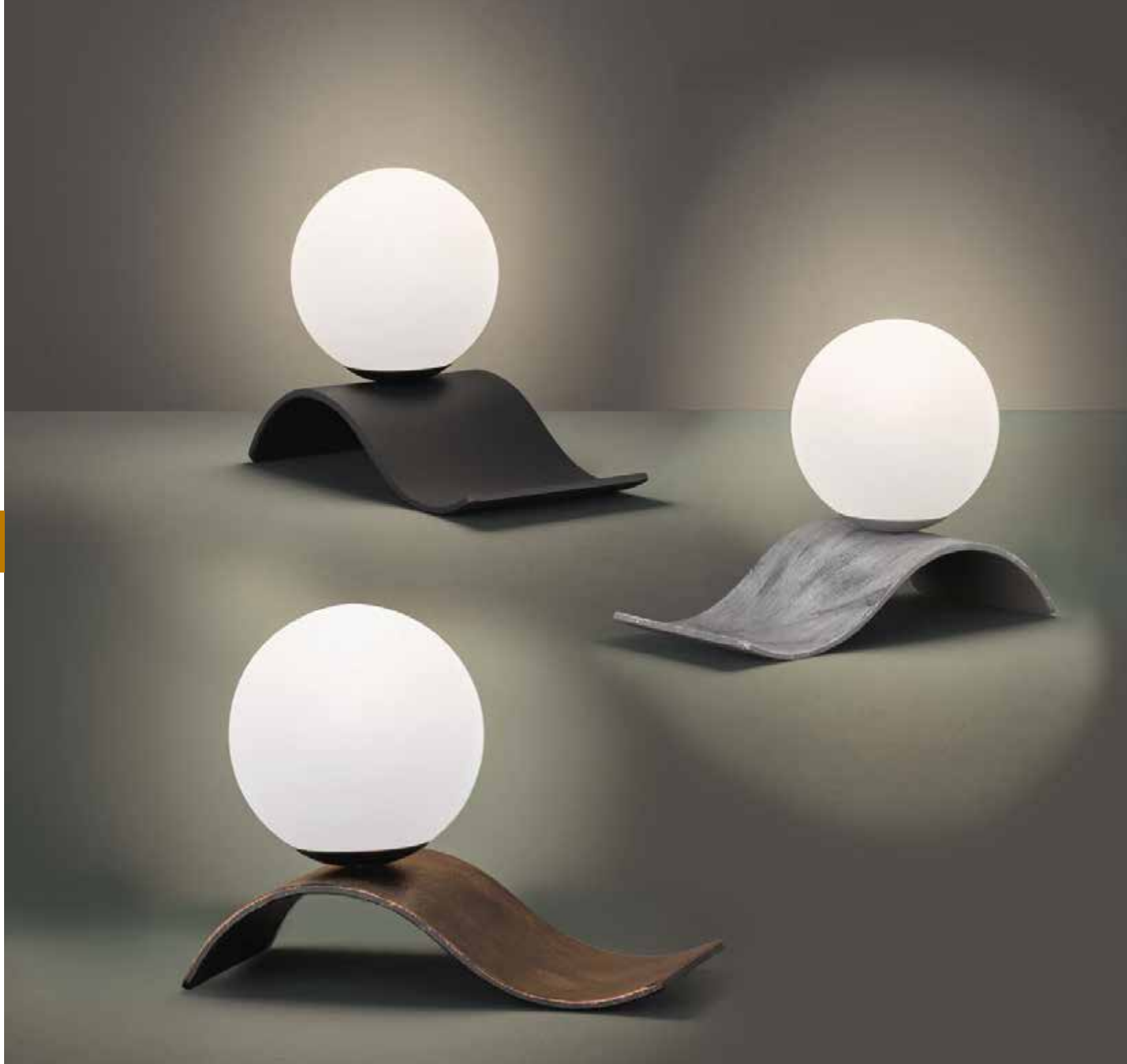

# LARA

Metall, Glas matt · metal, mat glass ·  
 metale, verre mat · metaal, mat glas · metal, vidrio mate ·  
 metallo, vetro sabbato · metal, sticla mata · metalli, mattalasi ·  
 metal, szkło matowane

**32** | Schwarz matt · black mat

**61** | Grau antik · antique grey

**62** | Kupfer antik · antique copper

Empfohlen:  
 recommended: LED E14, 4 W  
 320 lm, 3.000 K



**983-40**

Tischleuchte · Table lamp  
 ↔ 29 x 15 cm, ↑ 21 cm  
 excl. 1 x E14, max. 40 W



**508400132**  
**508400161**  
**508400162**

# CORD

Kupfer antik, Stoffkabel · antique copper, fabric sheathed cable ·  
 cuivre ancien, câble gainé de tissu · antiek koper, kabel met  
 stofmantel · cobre antiguo, cable forrado de tela · rame antico,  
 cavo rivestito in tessuto · cupru antic, țesătură din fibră de sticlă ·  
 antiikki kupari, kangaspäällysteinen kaapeli · antyczne miedzi,  
 kabel z osłoną z tkaniny

Empfohlen:  
 recommended: Filament LED E27, 6 W  
 660 lm, 2.700 K



**988-679**



Pendelleuchte · Pendant  
 Ø 12 cm, ↑ 150 cm  
 excl. 1 x E27, max. 60 W



**310100162**



Pendelleuchte · Pendant  
 ↑ 150 cm, ↔ max. 180 cm  
 excl. 5 x E27, max. 60 W



**310100562**





# JASMIN

Metall · metal ·  
metale · metaal · metal · metallo ·  
metal · metalli · metal

Pendelleuchte · Pendant  
Ø 19 cm, ↑ 150 cm  
excl. 1 x E14, max. 40 W



303700104  
303700161  
303700162

Empfohlen:  
recommended: Filament LED E14, 4 W  
470 lm, 2.700 K



989-400

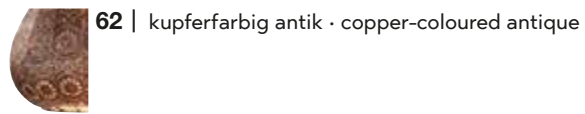
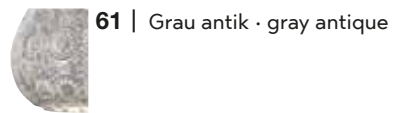
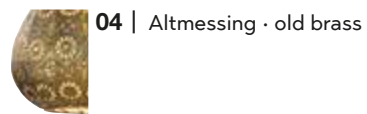

# FISHERMAN

Metall, Glas klar · metal, clear glass ·  
metale, verre claire · metaal, helder glas · metal, vidrio claro ·  
metallo, vetro chiaro · metal, sticlă transparentă · metalli, kirkas lasi · metal, przezroczyste szkło

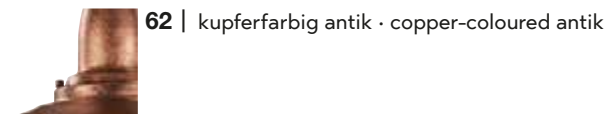
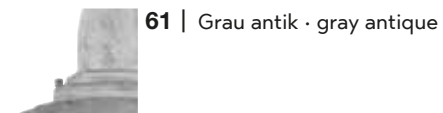
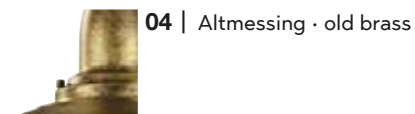

Empfohlen:  
recommended: Filament LED E27, 4 W  
470 lm, 2.700 K



987-400

Pendelleuchte · Pendant  
Ø 32 cm, ↑ 150 cm  
excl. 1 x E27, max. 28 W



304500104  
304500161  
304500162



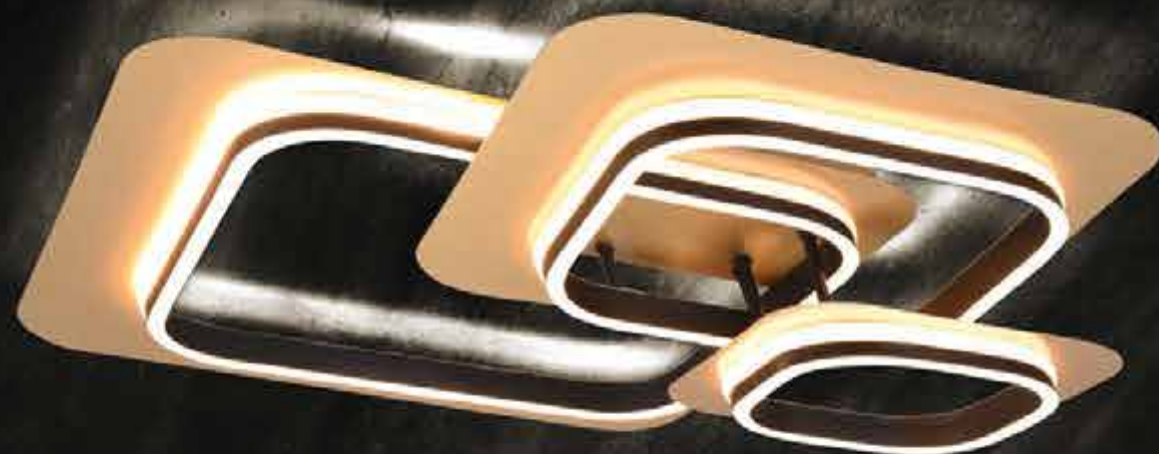

## Wand- & Deckenleuchten

Wall- & Ceiling lamps  
 Plafonniers & appliques  
 Wandlampen & plafonnières  
 Apliques y plafones  
 Applique e plafoniere  
 Plafoniere si aplice  
 Seinä- & katto  
 Sufitowe i ścienne





DIP SWITCH

Lichtfarben direkt an der Leuchte einstellbar · Colours directly adjustable at the lamp ·  
 Les couleurs de la lumière peuvent être réglées directement sur le luminaire ·  
 Lichtkleuren direct instelbaar op de lamp · Tonalidades de luz ajustables directamente en la lámpara ·  
 Colori della luce regolabili direttamente sulla lampada · Colori ale luminii reglabile direct de la bec ·  
 Valon väri asetettävissa suoraan valaisimesta · Barwy światła można ustawić bezpośrednio na oprawie

## CAYA

Aluminium gebürstet oder Messing matt, Schwarz matt · brushed aluminium or brass mat, black mat ·  
 Aluminium balayé ou Laiton mat, Noir mat · Geborsteld aluminium of Messing mat, Mat zwart ·  
 Aluminio pulido o Bronce mate, Estera negra · Alluminio spazzolato o Ottone satinato, Nero opaco ·  
 Aluminu lucios sau Bronz mat, Negru mat · Harjattu alumiini tai Mattamessinki, mattamusta ·  
 Aluminium szczotkowane lub Mosiądz mat, Czarny mat

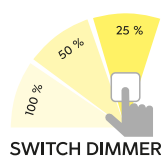

SWITCH DIMMER

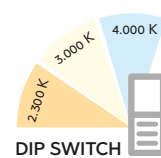

DIP SWITCH



**05** | Aluminium gebürstet / Schwarz matt ·  
 brushed aluminium / black mat

**08** | Messing matt / Schwarz matt ·  
 brass mat / black mat

Deckenleuchte · Ceiling lamp  
 Ø 50 cm, ↓ 9 cm  
 incl. SMD-LED, 58 W  
 6.800 lm, 2.300 + 3.000 + 4.000 K



641910205  
 641910208





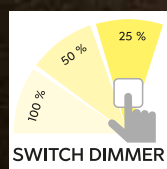

# LUGO

Metall, Schwarz matt, goldfarbig · metal, black mat, gold ·  
 Métal, Noir mat, Or · Metaal, Mat zwart, Goud · Metal, Estera negra, Oro · Metallo, Nero opaco, Oro ·  
 Metal, Negru mat, Aur · Metalli, mattamusta, Kultaa · Metal, Czarny mat, Złota



**Wandleuchte · Wall lamp**  
 ↔ 29 x 29 cm, ↗ 6,5 cm  
 incl. SMD-LED, 12 W  
 1.450 lm, 3.000 K



242910180



**Deckenleuchte · Ceiling lamp**  
 ↔ 52,5 x 54 cm, ↑ 10 cm  
 incl. SMD-LED, 28 W  
 3.400 lm, 3.000 K



642910280



**Deckenleuchte · Ceiling lamp**  
 ↔ 74 x 74 cm, ↑ 13 cm  
 incl. SMD-LED, 50 W  
 6.150 lm, 3.000 K



642910380







## GRANADA

Chrom, Weiß matt oder Schwarz matt, goldfarbig · chrome white mat, or black mat, gold · chrome blanc mat, ou noir mat, or · chroom wit mat, of mat zwart, goud · cromo estera blanca, o estera negra, oro · cromo bianco opaco, o nero opaco, oro · crom alb mat, sau negru mat, aur · kromi mattavalkoinen, tai mattamusta, kultaa · chrom biały mat, lub czarny mat, złota

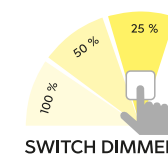

SWITCH DIMMER



Deckenleuchte · Ceiling lamp  
↔ 71,5 x 63,5 cm, ↑ 10,5 cm  
incl. SMD-LED, 36 W  
4.300 lm, 3.000 K



673810306  
673810332



Deckenleuchte · Ceiling lamp  
↔ 59 x 43 cm, ↑ 8,5 cm  
incl. SMD-LED, 29 W  
2.650 lm, 3.000 K



673810206  
673810232



Deckenleuchte · Ceiling lamp  
↔ 85 x 60 cm, ↑ 8,5 cm  
incl. SMD-LED, 36 W  
3.250 lm, 3.000 K



673890206  
673890232



06 | Chrom · chrome



32 | Schwarz matt · black mat



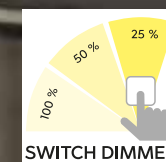
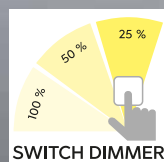

# GROOVY

Metall, Kristallglas · metal, crystalglass ·  
métal, cristalverre · metaal, kristalglas · metal, cristalvidrio ·  
metallo, cristallovetro · metal, cristalsticla · metalli, kristallilasi · metal, kryształszkło



Deckenleuchte · Ceiling lamp  
Ø 62,5 cm, ↑ 6 cm  
incl. SMD-LED, 30 W  
3.800 lm, 4.000 K

Deckenleuchte · Ceiling lamp  
↔ 95,5 x 40 cm, ↑ 6,5 cm  
incl. SMD-LED, 37 W  
4.800 lm, 4.000 K

Deckenleuchte · Ceiling lamp  
Ø 62,5 cm, ↑ 6 cm  
incl. SMD-LED, 30 W  
3.600 lm, 3.000 K

Deckenleuchte · Ceiling lamp  
↔ 95,5 x 40 cm, ↑ 6,5 cm  
incl. SMD-LED, 37 W  
4.600 lm, 3.000 K



642110331



642110431



642110332



642110432



31 | Weiß matt · white mat

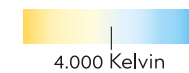

32 | Schwarz matt · black mat







## GALE

Metall, Nickel matt, Weiß matt oder Schwarz matt · metal, nickel mat, white mat or black mat ·  
 metale, nickel mat, blanc mat ou noir mat · metaal, nikkel mat, wit mat of mat zwart ·  
 metal, níquel mate, estera blanca o estera negra · metallo, nichel opaco, bianco opaco o nero  
 opaco · metal, nichel mat, alb mat sau negru mat · metalli, harjattu teräs, mattavalkoinen tai  
 mattamusta · metal, nikiel mat, biały mat lub czarny mat

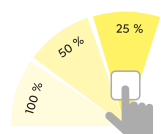

SWITCH DIMMER



07 | Nickel matt ·  
nickel mat



31 | Weiß matt ·  
white mat



32 | Schwarz matt ·  
black mat



Deckenleuchte · Ceiling lamp  
 ↔ 60 x 43 cm, ↑ 13,5 cm  
 incl. SMD-LED, 38,5 W  
 5.000 lm, 3.000 K



673916007  
 673916031  
 673916032



Deckenleuchte · Ceiling lamp  
 ↔ 80 x 65 cm, ↑ 14,5 cm  
 incl. SMD-LED, 50 W  
 7.000 lm, 3.000 K



673918007  
 673918031  
 673918032





# AVUS

Metall, Nickel matt · metal, nickel mat ·  
 metale, nickel mat · metaal, nikkel mat · metal, níquel mate ·  
 metallo, nichel opaco · metal, nichel mat · metalli, harjattu teräs ·  
 metal, nikiel mat

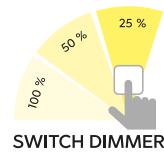

SWITCH DIMMER



308

Deckenleuchte · Ceiling lamp

↔ 90 x 25 cm, ↓ 9 cm  
 incl. SMD-LED, 35 W  
 3.700 lm, 3.000 K



629010107

# TIRIAC

Metall · metal ·  
 metale · metaal · metal · metallo · metal · metalli · metal

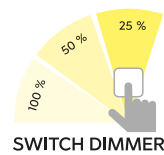

SWITCH DIMMER



07 | Nickel matt · nickel mat



31 | Weiß matt · white mat

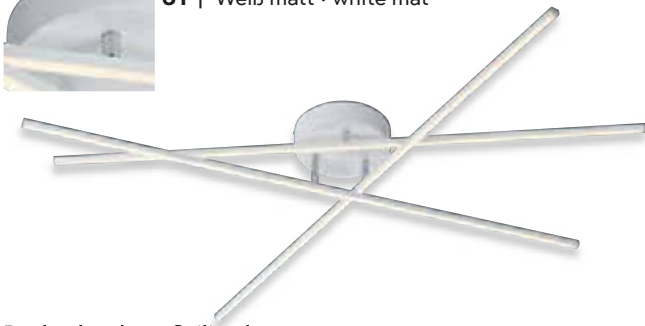

Deckenleuchte · Ceiling lamp

↔ 100 cm, ↓ 12 cm  
 incl. 3 x SMD, 8,5 W  
 3 x 950 lm, 3.000 K



671610307  
 671610331



309

# YAVA

Metall, Acryl · metal, acryl ·  
 metale, acryl · metaal, acryl · metal, acrílico ·  
 metallo, acrílico · metal, acrílic · metalli, akryyli · metal, akryl



Lichtfarbe stufenlos einstellbar ·  
 Light color infinitely variable



Integrierter Dimmer ·  
 Integrated dimmer



Deckenleuchte · Ceiling lamp

Ø 60 cm, ↓ 7 cm  
 incl. SMD-LED, 56 W  
 6.800 lm, 2.700 - 6.000 K



672310207  
 672310231  
 672310232



07 | Nickel matt · nickel mat



31 | Weiß matt · white mat



32 | Schwarz matt · black mat





DIP SWITCH

Lichtfarben direkt an der Leuchte einstellbar · Colours directly adjustable at the lamp ·  
 Les couleurs de la lumière peuvent être réglées directement sur le luminaire ·  
 Lichtkleuren direct instelbaar op de lamp · Tonalidades de luz ajustables directamente en la lámpara ·  
 Colori della luce regolabili direttamente sulla lampada · Culori ale luminii reglabile direct de la bec ·  
 Valon väri asetettävissä suoraan valaisimesta · Barwy światła można ustawić bezpośrednio na oprawie

## SALSA

Metall, Acryl · metal, acryl ·  
 metale, acryl · metaal, acryl · metal, acrilico ·  
 metallo, acrilico · metal, acrilic · metalli, akryyli · metal, akryl

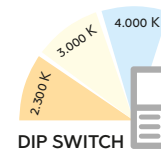

DIP SWITCH

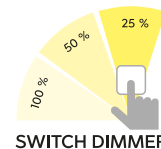

SWITCH DIMMER



31 | Weiß matt · white mat



32 | Schwarz matt · black mat



87 | titanfarbig · titan

Deckenleuchte · Ceiling lamp  
 ↔ 115 x 40,5 cm, ↑ 6,6 cm  
 incl. SMD-LED, 46 W  
 5.350 lm, 2.300 + 3.000 + 4.000 K



626710531  
 626710532  
 626710587



## CHARLESTON

Metall, Aluminium gebürstet oder Anthrazit · metal, brushed aluminium or anthracite ·  
 metale, aluminium balayé ou antracite · metaal, geborsteld aluminium of antraciet ·  
 metal, aluminio pulido o antracita · metallo, alluminio spazzolato o antracite ·  
 metal, aluminiu lucios sau antracit · metalli, harjattu alumiini tai antrasiitti ·  
 metal, aluminium szczotkowane lub antracyt



Getrennt schaltbar ·  
 Separately switchable



Memory Funktion ·  
 Memory function



1x



2x



3x



Deckenleuchte · Ceiling lamp

↔ 101 x 38 cm, ↑ 12,5 cm  
 incl. SMD-LED, 22 W  
 2.600 lm, 3.000 K  
 incl. SMD-LED, 12 W  
 1.600 lm, 3.000 K



672110505 | Aluminium gebürstet · brushed aluminium  
 672110542 | Anthrazit · anthracite





# SEDONA

Metall, Holznachbildung · metal, wood imitation ·  
metale, imitacion bois · metaal, houtimitatie ·  
metal, imitacion de madera · metallo, effetto legno ·  
metal, imitatie de lemn · metalli, puujäljitelmä ·  
metal, imitacja drewna

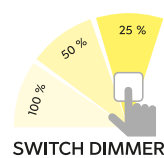

SWITCH DIMMER



31



06

Deckenleuchte · Ceiling lamp  
Ø 80 cm, ↑ 8 cm  
incl. SMD-LED, 40 W  
3.600 lm, 3.000 K



673210306 | Chrom · chrome  
673210331 | Weiß matt · white mat  
673210332 | Schwarz matt, Holznachbildung ·  
black mat, wood imitation



# TUCSON

Metall, Schwarz matt / Holznachbildung · metal, black mat / wood imitation ·  
Métal, Noir mat / imitation bois · Metaal, Mat zwart / houtimitatie · Metal, Estera negra / imitacion de madera ·  
Metallo, Nero opaco / effetto legno · Metal, Negru mat / imitatie de lemn · Metalli, mattamusta / puujäljitelmä ·  
Metal, Czarny mat / imitacja drewna

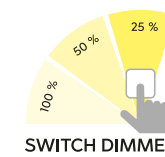

SWITCH DIMMER

Deckenleuchte · Ceiling lamp  
↔ 104 x 42 cm, ↑ 8,5 cm  
incl. SMD-LED, 35 W  
4.400 lm, 3.000 K



672610332



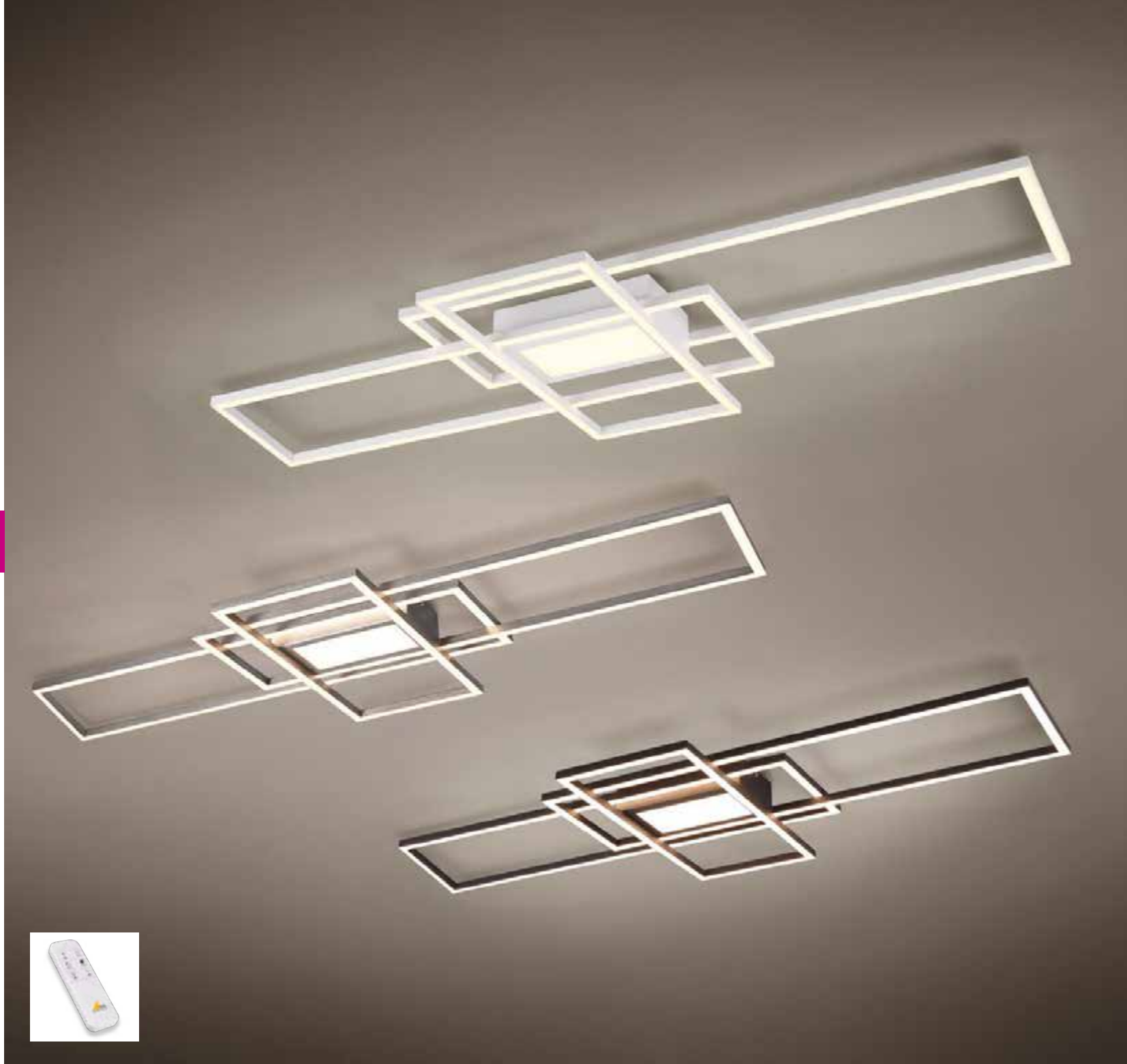



# IRVINE

Metall · metal ·  
metale · metaal · metal · metallo · metal · metalli · metal

 Lichtfarbe stufenlos einstellbar ·  
Light color infinitely variable

 Integrierter Dimmer ·  
Integrated dimmer

 Memory Funktion ·  
Memory function



Deckenleuchte · Ceiling lamp  
↔ 105 x 42 cm, ↑ 6,5 cm  
incl. SMD-LED, 60 W  
7.100 lm, 3.000 - 6.500 K



620010407  
620010408  
620010431  
620010442



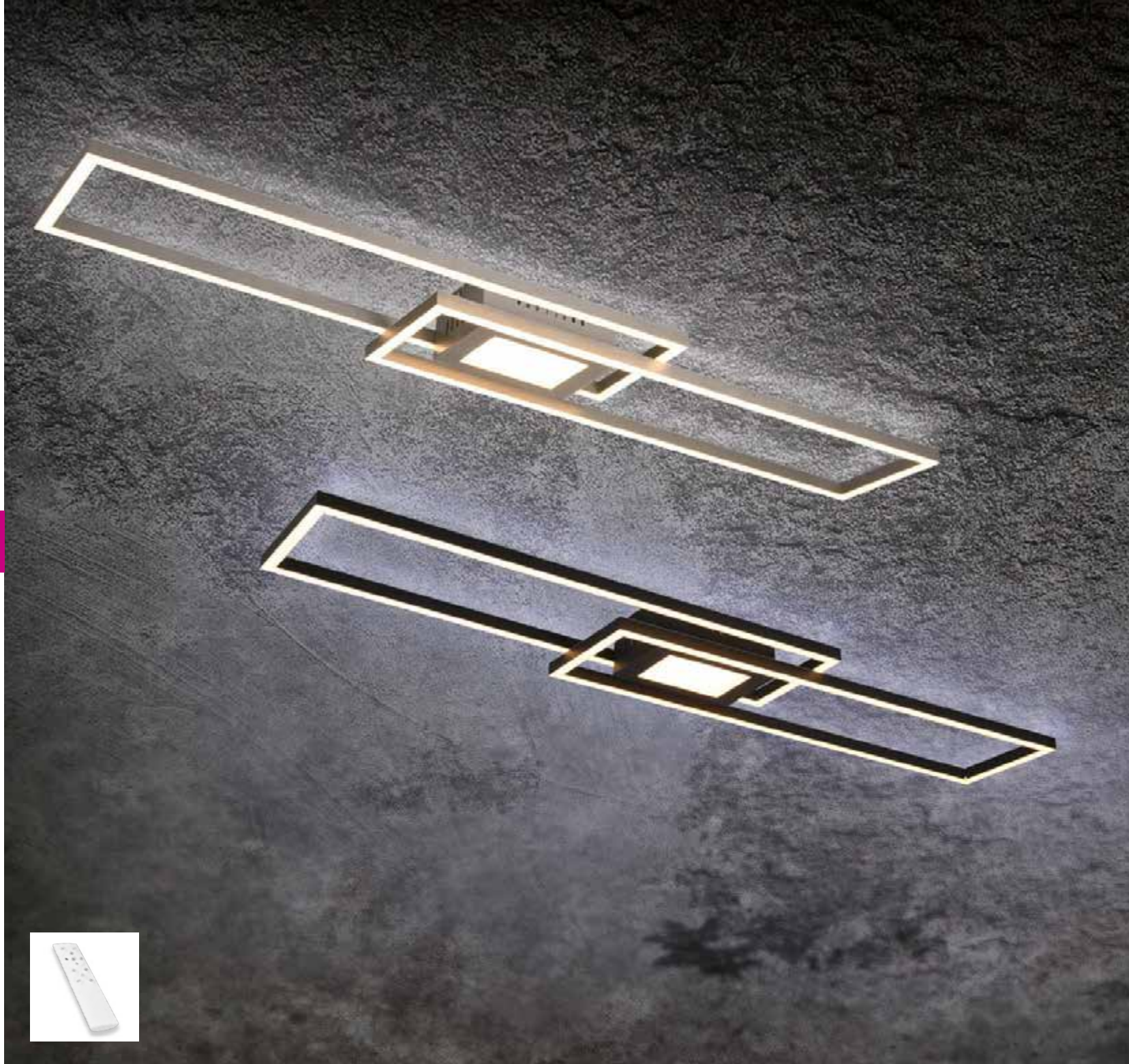

## GANADO

Metall, Nickel matt oder Schwarz matt · metal, nickel mat or black mat ·  
metale, nikel mat ou noir mat · metaal, nikkel mat of mat zwart · metal, níquel mate o estera negra ·  
metallo, nichel opaco o nero opaco · metal, nichel mat sau negru mat · metalli, harjattu teräs tai mattamusta ·  
metal, nikiel mat lub czarny mat



RGBW Farbwechsler ·  
RGBW Colorchanging



Lichtfarbe stufenlos einstellbar ·  
Light color infinitely variable



Getrennt schaltbar ·  
Separately switchable



indirekte Beleuchtung ·  
indirect lighting

### Deckenleuchte · Ceiling lamp

↔ 110 x 21,2 cm, ↑ 7 cm  
incl. SMD-LED, 37 W  
4.300 lm, 2.700 - 6.500 K  
incl. RGB-LED, 8 W



670710507 | Nickel matt · nickel mat  
670710532 | Schwarz matt · black mat



## WINONA

Metall, Nickel matt oder Schwarz matt · metal, nickel mat or black mat ·  
metale, nikel mat ou noir mat · metaal, nikkel mat of mat zwart ·  
metal, níquel mate o estera negra · metallo, nichel opaco o nero opaco ·  
metal, nichel mat sau negru mat · metalli, harjattu teräs tai mattamusta ·  
metal, nikiel mat lub czarny mat



RGBW Farbwechsler ·  
RGBW Colorchanging



Lichtfarbe stufenlos einstellbar ·  
Light color infinitely variable



Getrennt schaltbar ·  
Separately switchable



indirekte Beleuchtung ·  
indirect lighting



### Deckenleuchte · Ceiling lamp

↔ 78 x 62 cm, ↑ 11,5 cm  
incl. SMD-LED, 28 W  
3.200 lm, 2.700 - 6.500 K  
incl. RGB-LED, 10 W



670810607 | Nickel matt · nickel mat  
670810632 | Schwarz matt · black mat



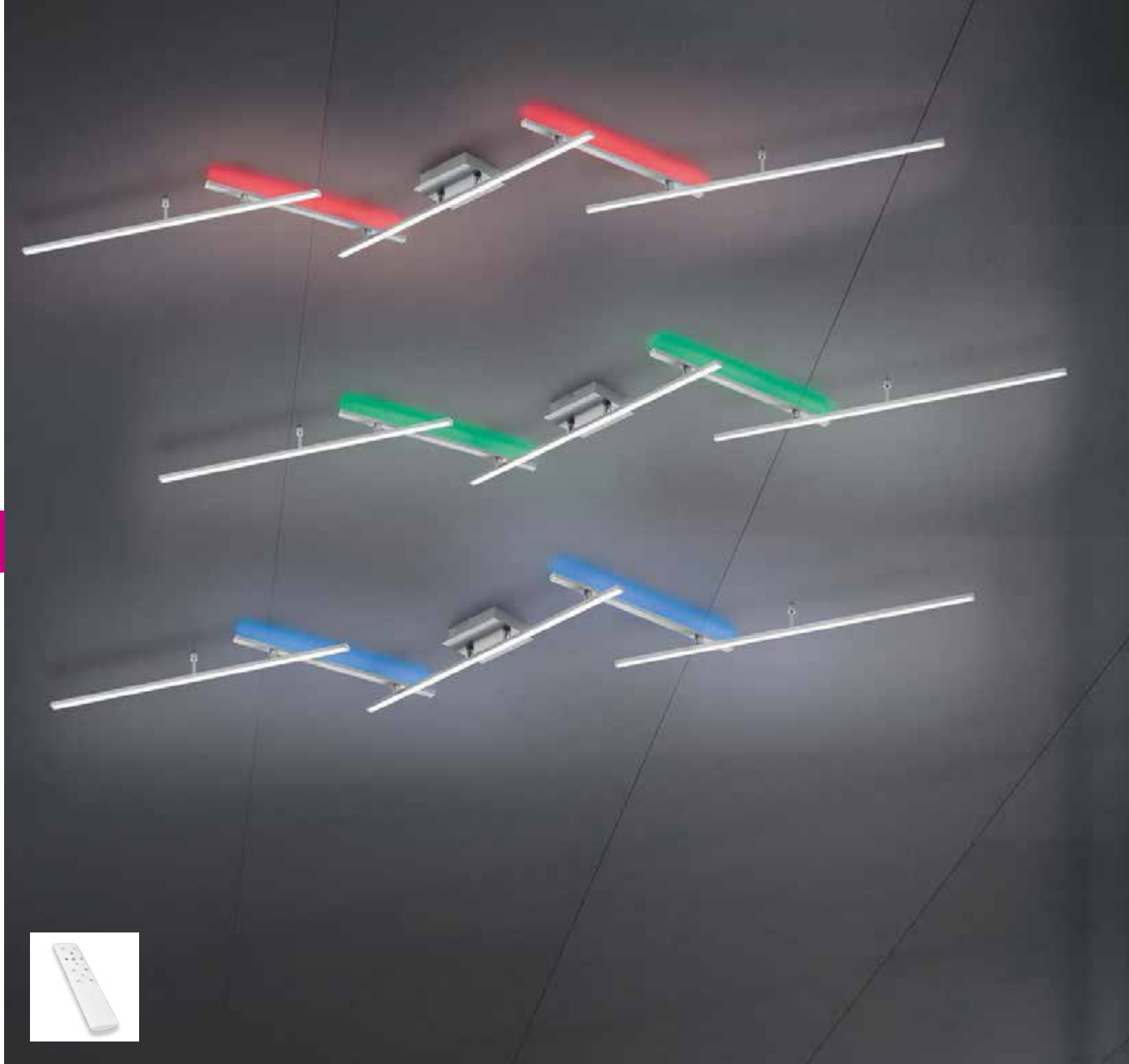

Gibt Licht nach oben und unten, getrennt schaltbar · up and down lighting, separately switchable ·  
 point lumineux en haut et en bas, interrupteurs séparés · lichtpunt boven en onder, gescheiden schakelbaar ·  
 luz de arriba y abajo, interruptores separados · luce su e giù, interruttori separati · sus și în jos lumina, intreruptoare separate ·  
 ylös ja alas valoa, erikseen kytkettävissä · w górę iw dół światło, oddzielny przełącznik



2.700 K

6.500 K



## ARVIN

Metall, Nickel matt oder Schwarz matt · metal, nickel mat or black mat ·  
 metale, nickel mat ou noir mat · metaal, nikkel mat of mat zwart · metal, níquel mate o estera negra ·  
 metallo, nichel opaco o nero opaco · metal, nichel mat sau negru mat · metalli, harjattu teräs tai mattamusta ·  
 metal, nikiel mat lub czarny mat



RGBW Farbwechsler ·  
 RGBW Colorchanging



Lichtfarbe stufenlos einstellbar ·  
 Light color infinitely variable



Getrennt schaltbar ·  
 Separately switchable



07 | Nickel matt · nickel mat

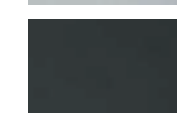

32 | Schwarz matt · black mat

### Deckenleuchte · Ceiling lamp

↔ max. 245 x 50 cm, ↑ 8,5 cm  
 incl. SMD-LED, 22 W  
 2.600 lm, 2.700 - 6.500 K  
 incl. RGB-LED, 8 W



628410507  
 628410532



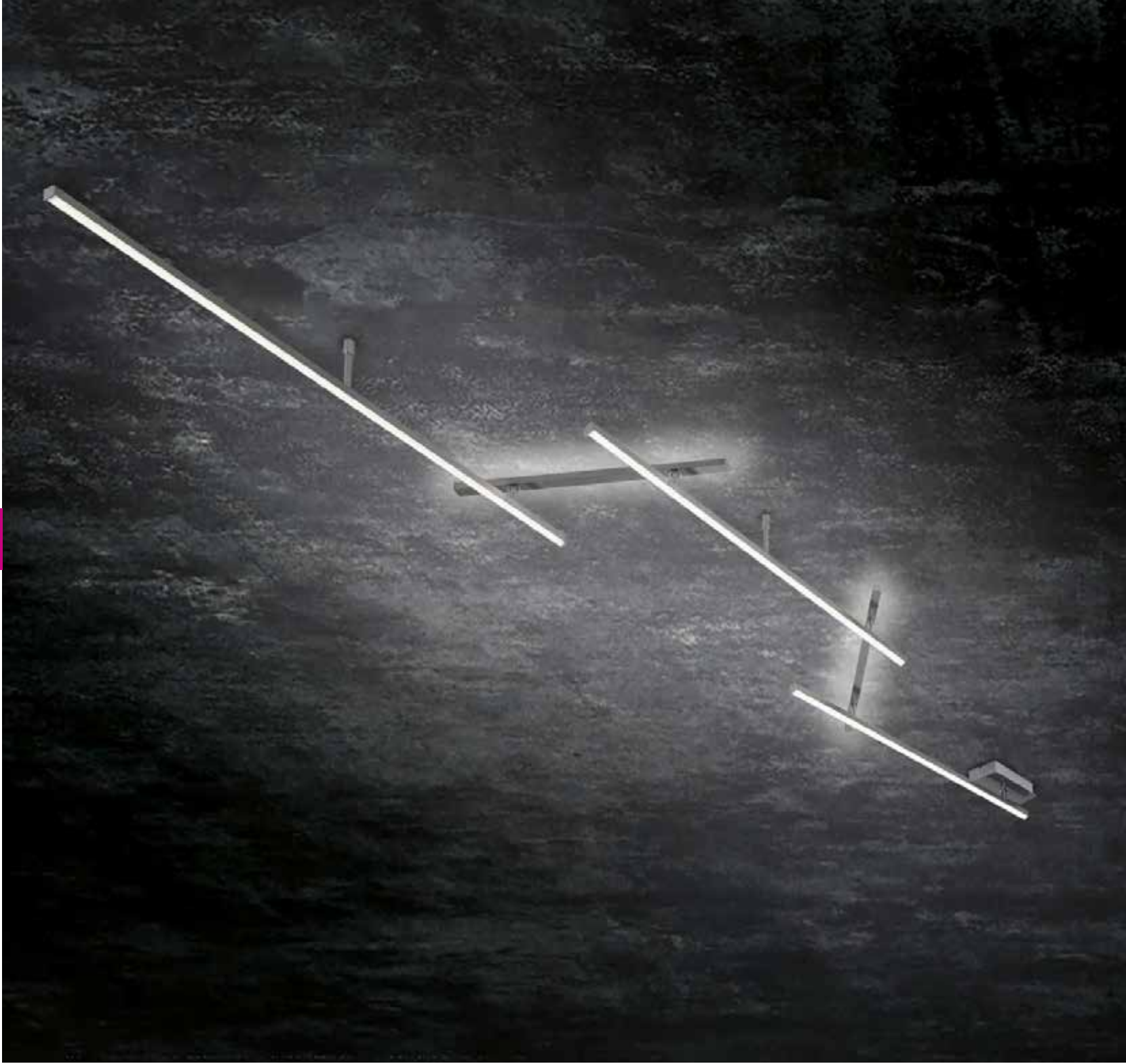

# INDIRA

Metall, Nickel matt, Acryl · metal, nickel mat, acryl ·  
 metale, nickel mat, acryl · metaal, nikkel mat, acryl · metal, níquel mate, acrílico ·  
 metallo, nichel opaco, acrílico · metal, nichel mat, acrílic · metalli, harjattu teräs, akryyli ·  
 metal, nikiel mat, akryl

Gibt Licht nach oben und unten · up and down lighting ·  
 point lumineux en haut et en bas · lichtpunt boven en onder · luz de arriba y abajo ·  
 luce su e giù · sus ši in jos lumina · ylös ja alas valoa · w górę iw dół światło

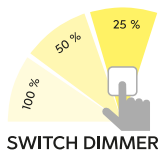

SWITCH DIMMER



Deckenleuchte · Ceiling lamp  
 ↔ max. 245 cm, ↑ 6,5 cm  
 incl. SMD-LED, 25 W  
 3.000 lm, 3.000 K



674610507

Deckenleuchte · Ceiling lamp  
 ↔ max. 345 cm, ↑ 6,5 cm  
 incl. SMD-LED, 28 W  
 3.500 lm, 3.000 K



674610707

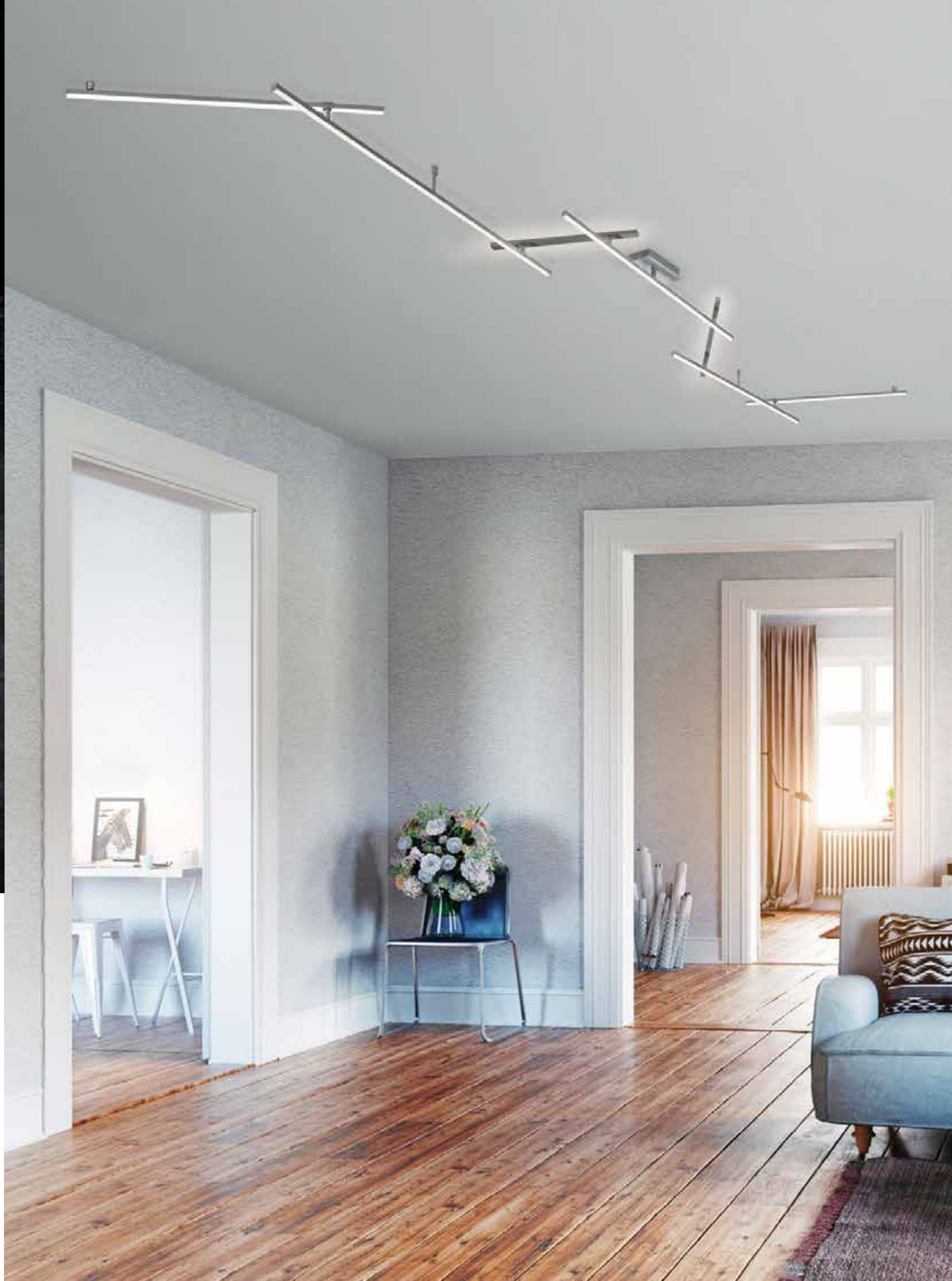



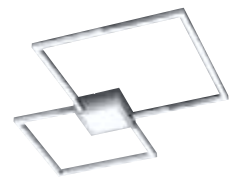
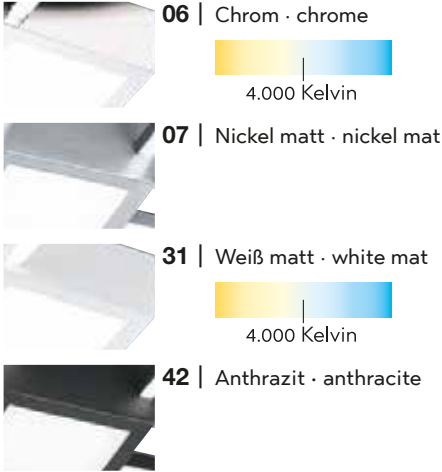
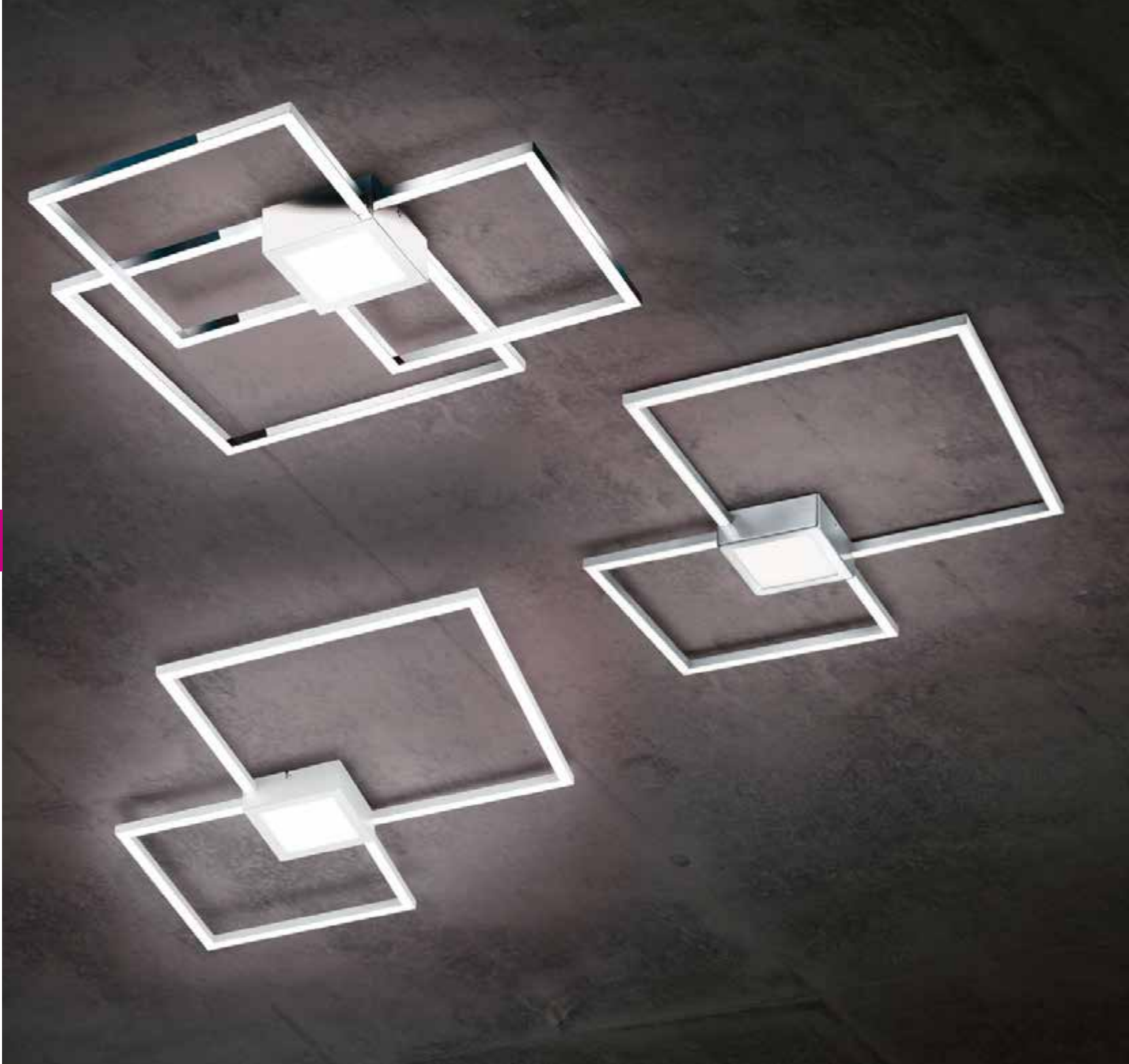

Deckenleuchte · Ceiling lamp  
↔ 65 x 65 cm, ↑ 5 cm  
incl. SMD-LED, 28 W  
3.200 lm, 4.000 K



676240306  
676240331

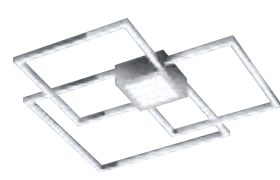

Deckenleuchte · Ceiling lamp  
↔ 65,5 x 66,5 cm, ↑ 6,5 cm  
incl. SMD-LED, 38 W  
4.400 lm, 4.000 K



676240406  
676240431

# HYDRA

Chrom, Nickel matt, Weiß matt oder Anthrazit · chrome, nickel mat, white mat or anthracite · chrome, nickel mat, blanc mat ou anthracite · chrom, nikel mat, wit mat of antraciet · cromo, níquel mate, estera blanca o antracita · cromo, nichel opaco, bianco opaco o antracite · crom, nichel mat, alb mat sau antracit · kromi, harjattu teräs, mattavalkoinen tai antrasiitti · chrom, nikel mat, biały mat lub antracyt

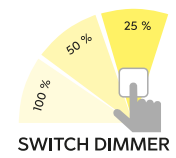

Deckenleuchte · Ceiling lamp  
↔ 65 x 65 cm, ↑ 5 cm  
incl. SMD-LED, 28 W  
2.600 lm, 3.000 K



676210307  
676210342

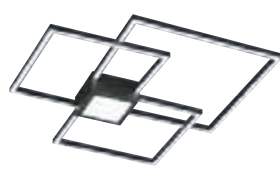

Deckenleuchte · Ceiling lamp  
↔ 65,5 x 66,5 cm, ↑ 6,5 cm  
incl. SMD-LED, 38 W  
4.000 lm, 3.000 K



676210407  
676210442



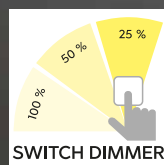

## OXFORD

Metall, Nickel matt, Weiß matt oder Anthrazit · metal, nickel mat, white mat or anthracite ·  
 metale, nickel mat, blanc mat ou antracite · metaal, nikkel mat, wit mat of antraciet · metal, níquel mate, estera blanca o antracita ·  
 metallo, nichel opaco, bianco opaco o antracite · metal, nichel mat, alb mat sau antracit · metalli, harjattu teräs, mattavalkoinen tai antrasiitti ·  
 metal, nikiel mat, biały mat lub antracyt

07 | Nickel matt · nickel mat



31 | Weiß matt · white mat



4.000 Kelvin

42 | Anthrazit · anthracite

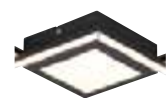

Deckenleuchte · Ceiling lamp  
 ↔ 102 x 78 cm, ↓ 5 cm  
 incl. SMD-LED, 27 W  
 3.000 lm, 3.000 K  
 (31 = 3.300 lm, 4.000 K)



674410307  
 674410331  
 674410342



2.700 K

6.500 K

## DOWNEY

Metall, Acryl · metal, acryl ·  
 metale, acryl · metaal, acryl · metal, acrilico ·  
 metallo, acrilico · metal, acrilic · metalli, akryyli · metal, akryl



Lichtfarbe stufenlos einstellbar ·  
 Light color infinitely variable



Integrierter Dimmer ·  
 Integrated dimmer



Memory Funktion ·  
 Memory function



Schwenkbar · tiltable

Deckenleuchte · Ceiling lamp  
 ↔ 64,5 x 86,5 cm, ↓ 89 cm  
 incl. SMD-LED, 33 W  
 4.600 lm, 2.700 - 6.500 K



620510307 | Nickel matt · nickel mat  
 620510331 | Weiß matt · white mat  
 620510332 | Schwarz matt · black mat





Getrennt schaltbar · Separately switchable

1x

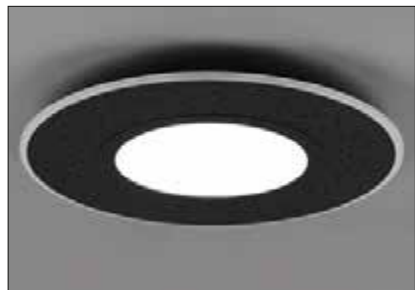

2x



3x



# VERUS

Metall, Acryl · metal, acryl ·  
metale, acryl · metaal, acryl · metal, acrilico ·  
metallo, acrilico · metal, acrilic · metalli, akryyli · metal, akryl

 Lichtfarbe stufenlos einstellbar ·  
Light color infinitely variable

 Integrierter Dimmer ·  
Integrated dimmer



07 | Nickel matt · nickel mat



32 | Schwarz matt · black mat



Deckenleuchte · Ceiling lamp  
Ø 50 cm, ↑ 7,2 cm  
incl. SMD-LED, 44 W  
5.300 lm, 3.000 K  
incl. SMD-LED, 20 W  
2.000 lm, 3.000 K



626910307  
626910332



Deckenleuchte · Ceiling lamp  
Ø 70 cm, ↑ 7,2 cm  
incl. SMD-LED, 70 W  
8.400 lm, 3.000 K  
incl. SMD-LED, 25 W  
2.500 lm, 3.000 K





626919307  
626919332





# TITUS

Metall, Weiß matt · metal, white mat ·  
 metale, blanc mat · metaal, wit mat · metal, estera blanca ·  
 metallo, bianco opaco · metal, alb mat · metalli, valkoinen matto ·  
 metal, biały mat

-  Lichtfarbe stufenlos einstellbar ·  
Light color infinitely variable
-  Integrierter Dimmer ·  
Integrated dimmer



**Deckenleuchte · Ceiling lamp**  
 ↔ 50 x 50 cm, ↑ 4,5 cm  
 incl. SMD-LED, 22 W  
 2.100 lm, 3.000 - 6.000 K



676615031



**Deckenleuchte · Ceiling lamp**  
 ↔ 75 x 75 cm, ↑ 4,5 cm  
 incl. SMD-LED, 36 W  
 3.300 lm, 3.000 - 6.000 K



676617531



**Deckenleuchte · Ceiling lamp**  
 ↔ 110 x 60 cm, ↑ 4,5 cm  
 incl. SMD-LED, 48 W  
 4.300 lm, 3.000 - 6.000 K



676611031



# RUBY

Metall Weiß matt · metal white mat ·  
 metale blanc mat · metaal wit mat ·  
 metal estera blanca · metallo bianco opaco ·  
 metal alb mat · metalli valkoinen matto ·  
 metal biały mat

-  Dimmbar ·  
Dimmable

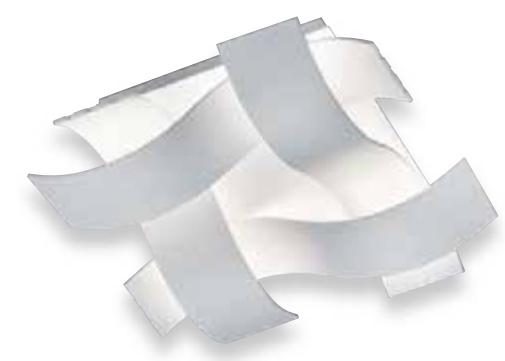

**Deckenleuchte · Ceiling lamp**  
 ↔ 35 x 35 cm, ↑ 11 cm  
 incl. SMD-LED, 18 W  
 1.800 lm, 3.000 K



623810431





## RAVEN

Schiefer, Schwarz · Shale, black ·  
Ardoise, noir · Leisteen, zwart · Pizarra, negro ·  
Ardesia, nero · Ardezie, negru · Savi, musta · łupek, czarny

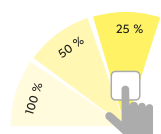

SWITCH DIMMER

 indirekte Beleuchtung ·  
indirect lighting



**Wandleuchte · Wall lamp**  
Ø 20 cm, ↗ 3,6 cm  
incl. SMD-LED, 9 W  
1.000 lm, 3.000 K



224290102



**Wandleuchte · Wall lamp**  
↔ 25 x 12 cm, ↗ 3,6 cm  
incl. SMD-LED, 9 W  
1.000 lm, 3.000 K



224210102

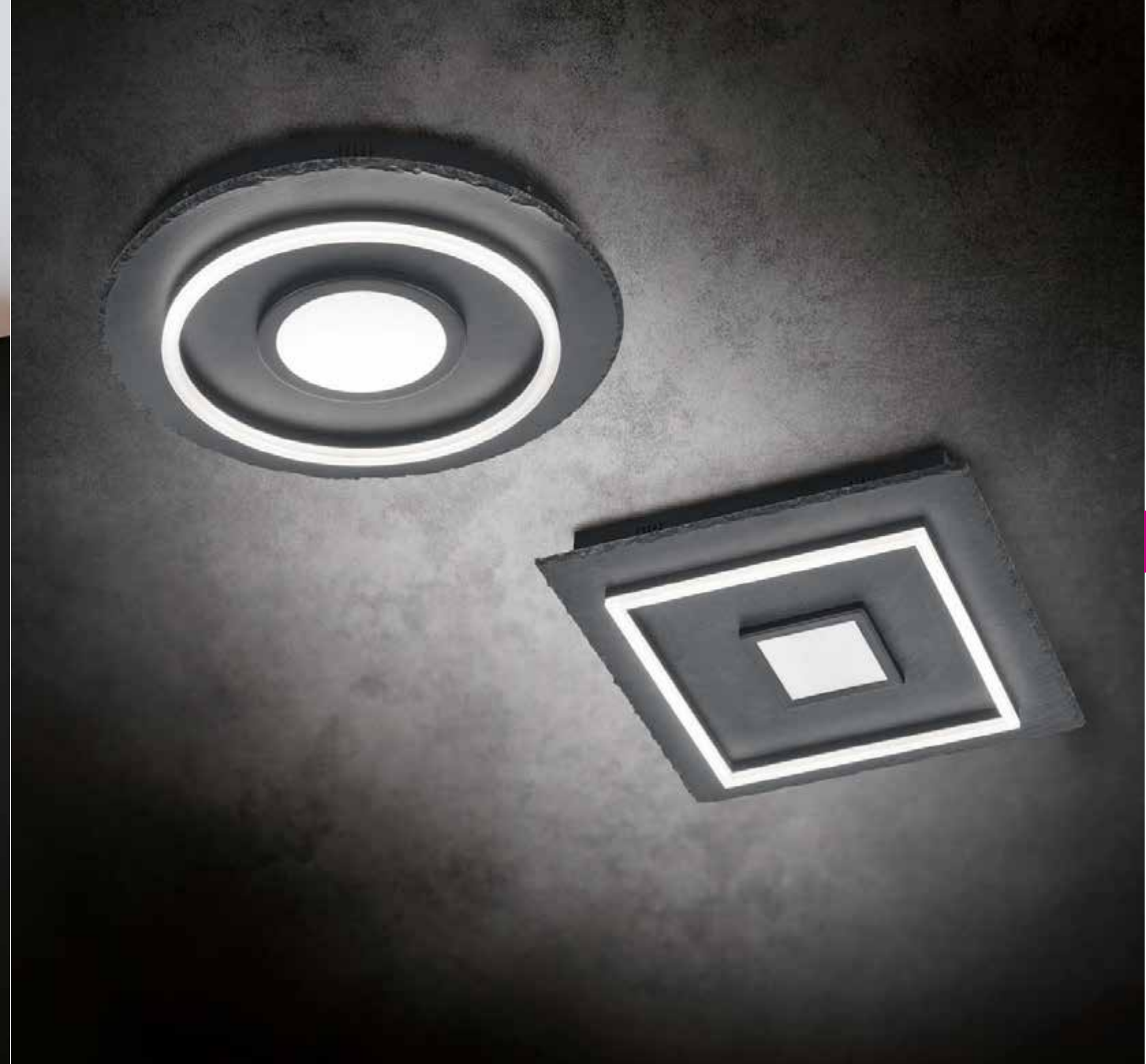

## CORBIE

Schiefer, Schwarz · Shale, black ·  
Ardoise, noir · Leisteen, zwart · Pizarra, negro · Ardesia, nero ·  
Ardezie, negru · Savi, musta · łupek, czarny

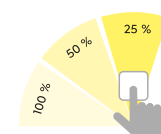

SWITCH DIMMER



**Wandleuchte · Wall lamp**  
Ø 40 cm, ↗ 6,4 cm  
incl. SMD-LED, 27 W  
3.100 lm, 3.000 K



672810202



**Wandleuchte · Wall lamp**  
↔ 40 x 40 cm, ↗ 6,4 cm  
incl. SMD-LED, 31 W  
3.600 lm, 3.000 K



672819202



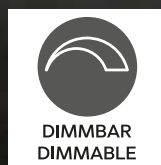
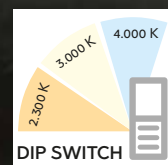

Lichtfarben direkt an der Leuchte einstellbar ·  
 Colours directly adjustable at the lamp ·  
 Les couleurs de la lumière peuvent être réglées directement sur le luminaire ·  
 Lichtkleuren direct instelbaar op de lamp ·  
 Tonalidades de luz ajustables directamente en la lámpara ·  
 Colori della luce regolabili direttamente sulla lampada ·  
 Culori ale luminii reglabile direct de la bec ·  
 Valon väri asetettävissa suoraan valaisimesta ·  
 Barwy światła można ustawić bezpośrednio na oprawie



2.300 K

3.000 K

4.000 K

## WACO

Metall, Acryl · metal, acryl ·  
 metale, acryl · metaal, acryl · metal, acrílico ·  
 metallo, acrílico · metal, acrílic · metalli, akryyli · metal, akryl

31 | Weiß matt · white mat

32 | Schwarz matt · black mat

87 | titanfarbig · titan



Deckenleuchte · Ceiling lamp  
 Ø 31 cm, ↓ 6,5 cm  
 incl. SMD-LED, 28 W  
 3.200 lm, 2.300 + 3.000 + 4.000 K



627413031  
 627413032  
 627413087



Deckenleuchte · Ceiling lamp  
 Ø 49,5 cm, ↓ 6,5 cm  
 incl. SMD-LED, 52,5 W  
 6.200 lm, 2.300 + 3.000 + 4.000 K



627415031  
 627415032  
 627415087



Deckenleuchte · Ceiling lamp  
 Ø 75 cm, ↓ 7 cm  
 incl. SMD-LED, 100 W  
 10.000 lm, 2.300 + 3.000 + 4.000 K



627417531  
 627417532  
 627417587





# PHOENIX

Metall, Schwarz matt, Acryl · metal, black mat, acryl ·  
métal, noir mat, acryl · metaal, mat zwart, acryl · metal, estera negra, acrílico ·  
metallo, nero opaco, acrilico · metal, negru mat, acrilic · metalli, mattamusta, akryyli ·  
metal, czarny mat, akryl



Deckenleuchte · Ceiling lamp  
Ø 30 cm, ↑ 4,2 cm  
incl. SMD-LED, 15 W  
1.700 lm, 3.000 K

Deckenleuchte · Ceiling lamp  
Ø 45 cm, ↑ 4,2 cm  
incl. SMD-LED, 26 W  
3.000 lm, 3.000 K

Deckenleuchte · Ceiling lamp  
Ø 62 cm, ↑ 4,2 cm  
incl. SMD-LED, 31 W  
3.600 lm, 3.000 K

Deckenleuchte · Ceiling lamp  
↔ 30 x 30 cm, ↑ 4,2 cm  
incl. SMD-LED, 15 W  
1.700 lm, 3.000 K

Deckenleuchte · Ceiling lamp  
↔ 45 x 45 cm, ↑ 4,2 cm  
incl. SMD-LED, 26 W  
3.000 lm, 3.000 K

Deckenleuchte · Ceiling lamp  
↔ 62 x 62 cm, ↑ 4,2 cm  
incl. SMD-LED, 31 W  
3.600 lm, 3.000 K

Deckenleuchte · Ceiling lamp  
↔ 120 x 30 cm, ↑ 4,2 cm  
incl. SMD-LED, 31 W  
3.600 lm, 3.000 K



674093032

674094532

674096232

674013032

674014532

674016232

674011232





## PHOENIX

Metall, Nickel matt, Acryl · metal, nickel mat, acryl ·  
 métal, nickel mat, acryl · metaal, nikkel mat, acryl · metal, níquel mate, acrílico ·  
 metallo, nichel opaco, acrilico · metal, nichel mat, acrilic · metalli, harjattu teräs, akryyli ·  
 metal, nikiel mat, akryl



Dimmbar ·  
Dimmable



Deckenleuchte · Ceiling lamp  
 Ø 30 cm, ↑ 4,2 cm  
 incl. SMD-LED, 15 W  
 1.700 lm, 3.000 K



674093007



Deckenleuchte · Ceiling lamp  
 Ø 45 cm, ↑ 4,2 cm  
 incl. SMD-LED, 26 W  
 3.000 lm, 3.000 K



674094507



Deckenleuchte · Ceiling lamp  
 Ø 62 cm, ↑ 4,2 cm  
 incl. SMD-LED, 31 W  
 3.600 lm, 3.000 K



674096207



Deckenleuchte · Ceiling lamp  
 ↔ 30 x 30 cm, ↑ 4,2 cm  
 incl. SMD-LED, 15 W  
 1.700 lm, 3.000 K



674013007



Deckenleuchte · Ceiling lamp  
 ↔ 45 x 45 cm, ↑ 4,2 cm  
 incl. SMD-LED, 26 W  
 3.000 lm, 3.000 K



674014507



Deckenleuchte · Ceiling lamp  
 ↔ 62 x 62 cm, ↑ 4,2 cm  
 incl. SMD-LED, 31 W  
 3.600 lm, 3.000 K



674016207



Deckenleuchte · Ceiling lamp  
 ↔ 120 x 30 cm, ↑ 4,2 cm  
 incl. SMD-LED, 31 W  
 3.600 lm, 3.000 K



674011207



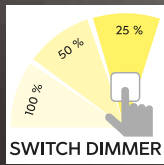

# GIRONA

Metall, Acryl · metal, acryl ·  
 metale, acryl · metaal, acryl · metal, acrilico ·  
 metallo, acrilico · metal, acrilic · metalli, akryyli · metal, akryl



Deckenleuchte · Ceiling lamp  
 Ø 45 cm, ↑ 11 cm  
 incl. SMD-LED, 27 W  
 3.200 lm, 3.000 K  
 (31 = 3.200 lm, 4.000 K)



671210131  
 671210132



Deckenleuchte · Ceiling lamp  
 Ø 60 cm, ↑ 12 cm  
 incl. SMD-LED, 48 W  
 5.600 lm, 2.700 - 6.000 K



671290131  
 671290132



2.700 K

6.500 K

31 | Weiß matt · white mat  
 4.000 Kelvin

32 | Schwarz matt · black mat





# ZEUS

Metall, Nickel matt oder Weiß matt · metal, nickel mat or white mat ·  
 metale, nickel mat ou blanc mat · metaal, nikkel mat of wit mat · metal, níquel mate o estera blanca ·  
 metallo, nichel opaco o bianco opaco · metal, nichel mat sau alb mat · metalli, harjattu teräs tai mattavalkoinen ·  
 metal, nikiel mat lub biały mat



01 | Weiß · white



07 | Nickel matt · nickel mat

**Deckenleuchte · Ceiling lamp**  
 ↔ 12 x 12 cm, ↓ 3,5 cm  
 incl. SMD-LED, 5,5 W  
 500 lm, 3.000 K

657110601  
 657110607

**Deckenleuchte · Ceiling lamp**  
 ↔ 18 x 18 cm, ↓ 3,5 cm  
 incl. SMD-LED, 15 W  
 1.500 lm, 3.000 K

657111201  
 657111207

**Deckenleuchte · Ceiling lamp**  
 ↔ 22,5 x 22,5 cm, ↓ 3,5 cm  
 incl. SMD-LED, 18 W  
 1.900 lm, 3.000 K

657111801  
 657111807

# CENTO

Metall, Nickel matt oder Weiß matt · metal, nickel mat or white mat ·  
 metale, nickel mat ou blanc mat · metaal, nikkel mat of wit mat · metal, níquel mate o estera blanca ·  
 metallo, nichel opaco o bianco opaco · metal, nichel mat sau alb mat · metalli, harjattu teräs tai mattavalkoinen ·  
 metal, nikiel mat lub biały mat



01 | Weiß · white



07 | Nickel matt · nickel mat

**Deckenleuchte · Ceiling lamp**  
 Ø 12 cm, ↓ 3,5 cm  
 incl. SMD-LED, 5,5 W  
 500 lm, 3.000 K

657010601  
 657010607

**Deckenleuchte · Ceiling lamp**  
 Ø 18 cm, ↓ 3,5 cm  
 incl. SMD-LED, 11,5 W  
 1.100 lm, 3.000 K

657011201  
 657011207

**Deckenleuchte · Ceiling lamp**  
 Ø 22,5 cm, ↓ 3,5 cm  
 incl. SMD-LED, 18 W  
 1.900 lm, 3.000 K

657011801  
 657011807





# FERNANDO

Metall, Weiß matt oder Schwarz matt · metal, white mat or black mat ·  
 metale, blanc mat ou noir mat · metaal, wit mat of mat zwart ·  
 metal, estera blanca o estera negra · metallo, bianco opaco o nero opaco ·  
 metal, alb mat sau negru mat · metalli, valkoinen matto tai musta matto ·  
 metal, biały mat lub czarny mat

Empfohlen:  
 recommended: LED GU10, 5 W  
 400 lm, 3.000 K



956-5936



31 | Weiß matt · white mat



32 | Schwarz matt · black mat



Deckenleuchte · Ceiling lamp  
 ↔ 23 x 20 cm, ↑ 15 cm  
 excl. 3 x GU10, max. 35 W



604900331  
 604900332



Deckenleuchte · Ceiling lamp  
 ↔ 37 x 30 cm, ↑ 15 cm  
 excl. 6 x GU10, max. 35 W



604900631  
 604900632





# COOKIE

Metall, Weiß matt oder Schwarz matt · metal, white mat or black mat ·  
metale, blanc mat ou noir mat · metaal, wit mat of mat zwart · metal, estera blanca o estera negra · metallo, bianco opaco o nero opaco ·  
metal, alb mat sau negru mat · metalli, valkoinen matto tai musta matto · metal, biały mat lub czarny mat

Empfohlen:  
recommended: LED GU10, 5 W  
400 lm, 3.000 K  
   
**956-5936**



Deckenleuchte · Ceiling lamp  
Ø 9,6 cm, ↑ 12,5 cm  
excl. 1 x GU10, max. 35 W



612900131  
612900132



Deckenleuchte · Ceiling lamp  
↔ 17,8 x 9,6 cm, ↑ 12,5 cm  
excl. 2 x GU10, max. 35 W



612900231  
612900232



Deckenleuchte · Ceiling lamp  
↔ 17,8 x 17,8 cm, ↑ 12,5 cm  
excl. 4 x GU10, max. 35 W



612900431  
612900432



# BISCUIT

Metall, Weiß matt oder Schwarz matt · metal, white mat or black mat ·  
metale, blanc mat ou noir mat · metaal, wit mat of mat zwart · metal, estera blanca o estera negra · metallo, bianco opaco o nero opaco ·  
metal, alb mat sau negru mat · metalli, valkoinen matto tai musta matto · metal, biały mat lub czarny mat

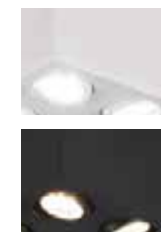

31 | Weiß matt · white mat

32 | Schwarz matt · black mat



Deckenleuchte · Ceiling lamp  
↔ 9,6 x 9,6 cm, ↑ 12,5 cm  
excl. 1 x GU10, max. 35 W



613000131  
613000132



Deckenleuchte · Ceiling lamp  
↔ 17,8 x 9,6 cm, ↑ 12,5 cm  
excl. 2 x GU10, max. 35 W



613000231  
613000232



Deckenleuchte · Ceiling lamp  
↔ 17,8 x 17,8 cm, ↑ 12,5 cm  
excl. 4 x GU10, max. 35 W



613000431  
613000432



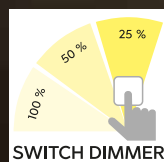

# LUGANO

Stoffschirm, Acryl · fabric shade, acryl · abat-jour tissu, acryl · Stoffen kap, acryl · Pantalla de tela, acrilico · paralume in tessuto, acrilico · abajur textil, acrilic · kangas varjostin, akryyli · Klosz z materiału, akryl



Lichtfarbe stufenlos einstellbar · Light color infinitely variable



Integrierter Dimmer · Integrated dimmer



Memory Funktion · Memory function



01 | Weiß · white



11 | Grau · grey



Deckenleuchte · Ceiling lamp  
Ø 30 cm, ↑ 9 cm  
incl. SMD-LED, 11 W  
1.200 lm, 3.000 K

621911201  
621911211



Deckenleuchte · Ceiling lamp  
Ø 40 cm, ↑ 10,5 cm  
incl. SMD-LED, 22 W  
2.200 lm, 3.000 K



621912401  
621912411



Deckenleuchte · Ceiling lamp  
Ø 60 cm, ↑ 10 cm  
incl. SMD-LED, 42 W  
4.900 lm, 3.000 - 5.000 K



621914001  
621914011



Deckenleuchte · Ceiling lamp  
Ø 75 cm, ↑ 10 cm  
incl. SMD-LED, 60 W  
5.000 lm, 3.000 - 5.000 K



621915501  
621915511





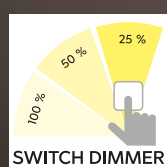

# LUGANO

Stoffschirm, Acryl · fabric shade, acryl · abat-jour tissu, acryl · Stoffen kap, acryl · Pantalla de tela, acrílico · paralume in tessuto, acrilico · abajur textil, acrilic · kangas varjostin, akryyli · Klosz z materiału, akryl

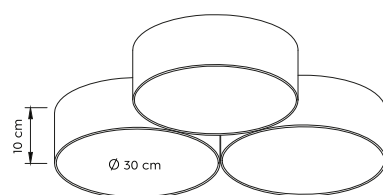

**Deckenleuchte · Ceiling lamp**  
↔ 64,5 x 64,5 cm, ↑ 14 cm  
incl. SMD-LED, 38 W  
4.200 lm, 3.000 K



621910301  
621910302  
621910317

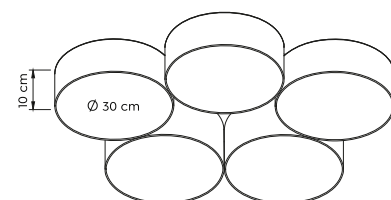

**Deckenleuchte · Ceiling lamp**  
↔ 86,5 x 69 cm, ↑ 14 cm  
incl. SMD-LED, 58 W  
6.300 lm, 3.000 K



621910501  
621910502  
621910517

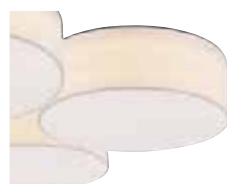

01 | Weiß · white



02 | Schwarz · black



17 | mehrfarbig · multicolor





# CRYSTEL

Chrom, Glas chrom bedampft, Acryl · chrome, chrome plated glass, acryl ·  
 Chrome, Verre plaqué chrome, Acryl · Chroom, Chroom opgedampt glas, Acryl · Cromo, Vidrio cromado, Acrílico ·  
 Cromo, Vetro verniciato cromo, Acrilico · Crom, Sticla cromata, Acrilic · Kromi, Kromipäällystetty lasi, Akryyli ·  
 Chrom, Szkło chromowane, Akryl

Empfohlen:  
 recommended: Filament LED E14, 4 W  
 470 lm, 2.700 K



983-400



Deckenleuchte · Ceiling lamp  
 Ø 34 cm, ↓ 17,5 cm  
 excl. 3 x E14, max. 28 W



616700306



Deckenleuchte · Ceiling lamp  
 Ø 50 cm, ↓ 23,5 cm  
 excl. 5 x E14, max. 28 W



616700506



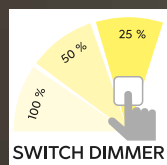

## BULLET

Metall, Glas · metal, glass ·  
metale, verre · metaal, glas · metal, vidrio ·  
metallo, vetro · metal, sticla · metalli, lasi · metal, szkło



**06** | Chrom, Glas chrom bedampft ·  
chrome, chrome plated glass



**07** | Nickel matt, Glas weiß matt ·  
nickel mat, white mat glass



**32** | Schwarz matt, Glas weiß matt ·  
black mat, white mat glass

Deckenleuchte · Ceiling lamp  
Ø 100 cm, ↑ 15,8 cm  
incl. 21 x SMD-LED, 1,5 W  
21 x 170 lm, 3.000 K



641412106  
641412107  
641412132







# PEACOCK

Metall, schwarz matt · metal, black mat ·  
metale, noir mat · metaal, mat zwart · metal, estera negra · metallo, nero opaco ·  
metal, negru mat · metalli, mattamusta · metal, czarny mat

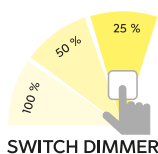

SWITCH DIMMER

Deckenleuchte · Ceiling lamp  
↔ 115 x 97,5 cm, ↑ 10,5 cm  
incl. 15 x SMD-LED, 2,6 W  
15 x 270 lm, 3.000 K





679511532



# BODRUM

Chrom · chrome ·  
chrome · chroom · cromo · cromo · crom · kromi · chrom · krom

 Lichtfarbe stufenlos einstellbar ·  
Light color infinitely variable

 Memory Funktion ·  
Memory function



3.000 K

6.500 K

Deckenleuchte · Ceiling lamp  
Ø 100 cm, ↑ 8,5 cm  
incl. 12 x SMD-LED, 2,2 W  
12 x 250 lm, 3.000 - 6.500 K  
incl. 1 x SMD-LED, 5 W  
550 lm, 3.000 - 6.500 K



673311306





# MITA

Metall Weiß matt, Acryl · metal white mat, acryl ·  
metale blanc mat, acryl · metaal wit mat, acryl ·  
metal estera blanca, acrílico · metallo bianco opaco, acrilico ·  
metal alb mat, acrylic · metalli valkoinen matto, akryyli · metal biały mat, akryl



Lichtfarbe stufenlos einstellbar ·  
Light color infinitely variable



Integrierter Dimmer ·  
Integrated dimmer



Deckenleuchte · Ceiling lamp  
Ø 51 cm, ↑ 7 cm  
incl. SMD-LED, 74 W  
9.000 lm, 2.700 - 6.000 K



629210331



Deckenleuchte · Ceiling lamp  
↔ 51,5 x 51,5 cm, ↑ 7 cm  
incl. SMD-LED, 76 W  
9.250 lm, 2.700 - 6.000 K



629219331



2.700 K

6.000 K







# KAGAWA

Metall Weiß matt, Acryl · metal white mat, acryl ·  
metale blanc mat, acryl · metaal wit mat, acryl ·  
metal estera blanca, acrílico · metallo bianco opaco, acrilico ·  
metal alb mat, acrylic · metalli valkoinen matto, akryyli · metal biały mat, akryl

- Lichtfarbe stufenlos einstellbar · Light color infinitely variable
- Memory Funktion · Memory function
- Nachtlcht · Night light



Deckenleuchte · Ceiling lamp  
Ø 50 cm, ↑ 6 cm  
incl. SMD-LED, 40 W  
5.000 lm, 2.700 - 6.000 K

625815031

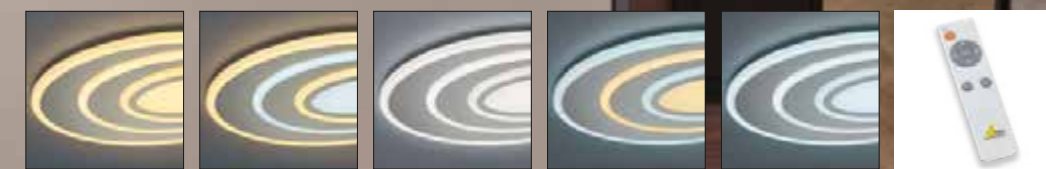
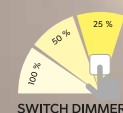

# SUBARA

Metall Weiß matt, Acryl · metal white mat, acryl ·  
metale blanc mat, acryl · metaal wit mat, acryl ·  
metal estera blanca, acrílico · metallo bianco opaco, acrilico ·  
metal alb mat, acrylic · metalli valkoinen matto, akryyli · metal biały mat, akryl

- Lichtfarbe stufenlos einstellbar · Light color infinitely variable
- Memory Funktion · Memory function



Deckenleuchte · Ceiling lamp  
↔ 40 x 26 cm, ↑ 5,6 cm  
incl. SMD-LED, 20 W  
2.100 lm, 3.000 + 4.000 K

274510107



Deckenleuchte · Ceiling lamp  
↔ 88 x 58 cm, ↑ 6,4 cm  
incl. SMD-LED, 58 W  
5.400 lm, 3.000 - 5.500 K

674510107



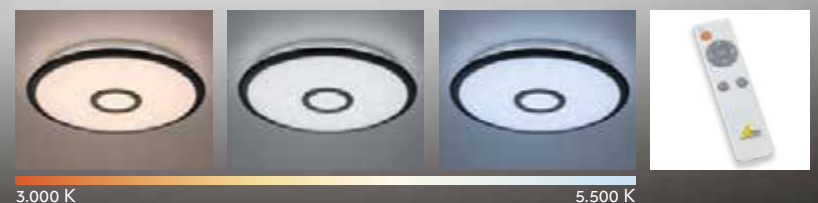
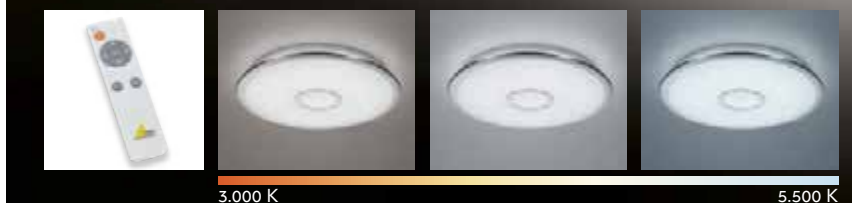

# OSAKA

Chrom, Acryl, Starlight-Effekt · chrome, acryl, starlight effect ·  
 chrome, acryl, effet étoile · chrom, acryl, sterlicht effect · cromo, acrílico, efecto de la luz · cromo, acrilico, effetto di stelle ·  
 crom, acrilic, efect lumina stelelor · kromi, akryyli, starlight vaikutus · chrom, akryl, efekt starlight

- 

**Deckenleuchte · Ceiling lamp**  
 Ø 21 cm, ↓ 5 cm  
 incl. SMD-LED, max. 12 W  
 max. 1.160 lm, 3.000 K



678711206
- 

**Deckenleuchte · Ceiling lamp**  
 Ø 42 cm, ↓ 7 cm  
 incl. SMD-LED, max. 27 W  
 max. 3.100 lm, 3.000 - 5.500 K



678713006
- 

**Deckenleuchte · Ceiling lamp**  
 Ø 67 cm, ↓ 10 cm  
 incl. SMD-LED, max. 91,5 W  
 max. 11.000 lm, 3.000 - 5.500 K



678710006

# OKINAWA

Metall, Acryl, Schwarz matt · metal, acryl, black mat ·  
 metale, acryl, noir mat · metaal, acryl, mat zwart · metal, acrílico, estera negra ·  
 metallo, acrilico, nero opaco · metal, acrilic, negru mat · metalli, akryyli, mattamusta · metal, akryl, czarny mat

- 

**Deckenleuchte · Ceiling lamp**  
 Ø 21 cm, ↓ 5 cm  
 incl. SMD-LED, 12 W  
 1.160 lm, 3.000 K



679112132
- 

**Deckenleuchte · Ceiling lamp**  
 Ø 42 cm, ↓ 7,5 cm  
 incl. SMD-LED, 18 W  
 1.800 lm, 3.000 - 5.500 K



679114232
- 

**Deckenleuchte · Ceiling lamp**  
 Ø 65 cm, ↓ 10 cm  
 incl. SMD-LED, 45 W  
 5.300 lm, 3.000 - 5.500 K





679110032



# SEIKO

Acryl, Starlight-Effekt · acryl, starlight effect · acryl, effet étoile · acryl, sterlicht effect · acrílico, efecto de la luz · acrilico, effetto di stelle · acrilic, efect lumina stelelor · akryyli, starlight vaikutus · akryl, efekt starlight

 Lichtfarbe stufenlos einstellbar · Light color infinitely variable

 Memory Funktion · Memory function



## Deckenleuchte · Ceiling lamp

Ø 42,5 cm, ↑ 6 cm  
incl. SMD-LED, 21,5 W  
2.400 lm, 3.000-5.500 K



678513001

# TOKYO

Acryl · acryl · acryl · acrílico · acrilico · acrilic · akryyli · akryl

 Lichtfarbe stufenlos einstellbar · Light color infinitely variable

 Memory Funktion · Memory function



## Deckenleuchte · Ceiling lamp

Ø 60 cm, ↑ 6,5 cm  
incl. SMD-LED, 45 W  
4.000 lm, 3.000 - 5.500 K



628915001



# MIKO

Chrom, Acryl, Starlight-Effekt · chrome, acryl, starlight effect · chrome, acryl, effet étoile · chroom, acryl, sterlicht effect · cromo, acrílico, efecto de la luz · cromo, acrilico, effetto di stelle · crom, acrilic, efect lumina stelelor · kromi, akryyli, starlight vaikutus · chrom, akryl, efekt starlight · krom, akrilik, starlight etkisi

 Lichtfarbe stufenlos einstellbar · Light color infinitely variable

 Integrierter Dimmer · Integrated dimmer

 Memory Funktion · Memory function



3.000 K

5.500 K

## Deckenleuchte · Ceiling lamp

Ø 85 cm, ↑ 12,5 cm  
incl. SMD-LED, 90 W  
10.800 lm, 3.000 - 5.500 K





675610106



# SHOGUN

Acryl, Starlight-Effekt · acryl, starlight effect · acryl, effet étoile · acryl, sterlicht effect · acrílico, efecto de la luz · acrilico, effetto di stelle · acrilic, efect lumina stelelor · akryyli, starlight vaikutus · akryl, efekt starlight

 Lichtfarbe stufenlos einstellbar · Light color infinitely variable

 Memory Funktion · Memory function

Deckenleuchte · Ceiling lamp

Ø 42,5 cm, ↑ 6 cm  
incl. SMD-LED, 21,5 W  
2.400 lm, 3.000-5.500 K



628513001

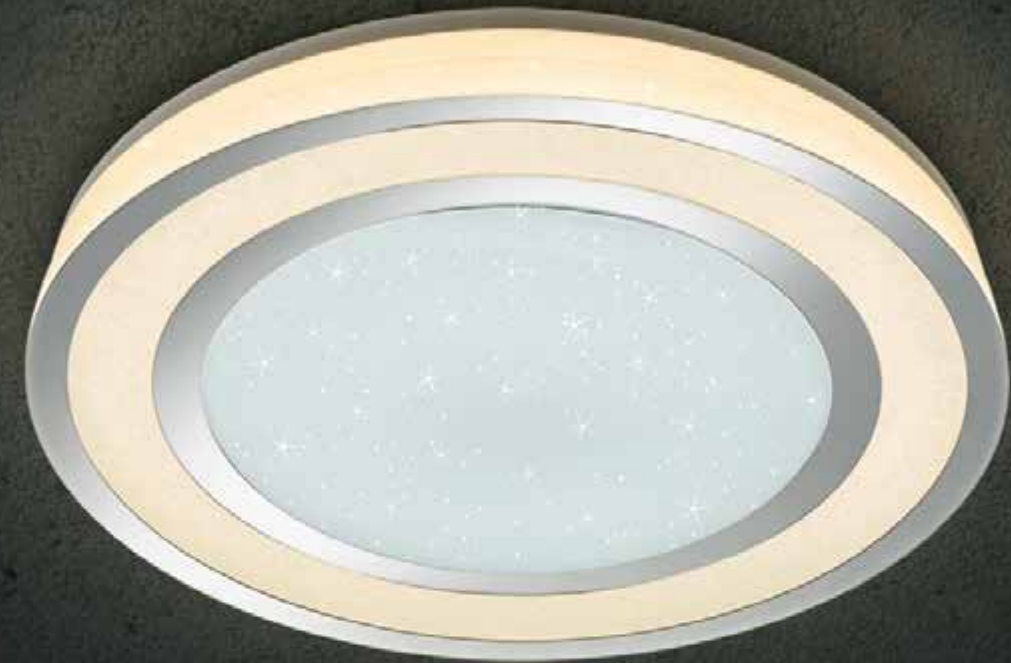

# SAMURAI

Acryl, Starlight-Effekt · acryl, starlight effect · acryl, effet étoile · acryl, sterlicht effect · acrílico, efecto de la luz · acrilico, effetto di stelle · acrilic, efect lumina stelelor · akryyli, starlight vaikutus · akryl, efekt starlight

 Lichtfarbe stufenlos einstellbar · Light color infinitely variable

 Memory Funktion · Memory function

Deckenleuchte · Ceiling lamp

↔ 42,5 x 42,5 cm, ↑ 6 cm  
incl. SMD-LED, 21,5 W  
2.400 lm, 3.000-5.500 K



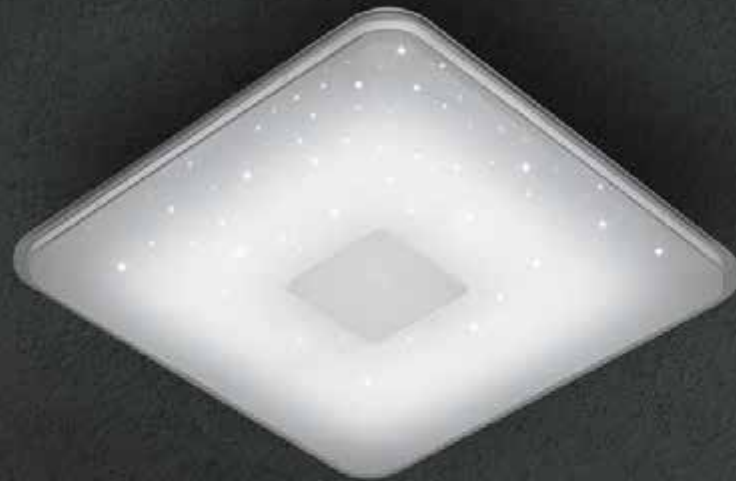

628613001



# NORIAKI

Chrom, Acryl, Starlight-Effekt · chrome, acryl, starlight effect · chrome, acryl, effet étoile · chroom, acryl, sterlicht effect · cromo, acrílico, efecto de la luz · cromo, acrilico, effetto di stelle · crom, acrilic, efect lumina stelelor · kromi, akryyli, starlight vaikutus · chrom, akryl, efekt starlight

 Lichtfarbe stufenlos einstellbar · Light color infinitely variable

 Integrierter Dimmer · Integrated dimmer

 Memory Funktion · Memory function

 Getrennt schaltbar · Separately switchable



Deckenleuchte · Ceiling lamp

Ø 59,5 cm, ↑ 10 cm  
incl. SMD-LED, 40 W  
4.750 lm, 3.000-5.500 K



679210106





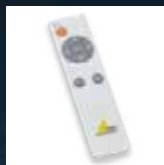

# LUNAR

Kunststoff · plastic · plastique · kunststof · plástico · plastica · plastic · muovi · plastik · plastik

Mondphasen individuell einstellbar · Phases of the moon individually adjustable · Phases de lune réglables · Maanstanden apart instelbaar · Fases lunares ajustables individualmente · Fasi lunari regolabili individualmente · Fazele lunii reglabile individual · Kuun vaiheet erikseen säädettävissä · Cykl księżyca indywidualnie regulowany

 **Musterschutz · Registered model**

 **Integrierter Dimmer · Integrated dimmer**



**Deckenleuchte · Ceiling lamp**  
 Ø 40 cm, ↓ 10 cm  
 incl. SMD-LED, 22 W  
 2.460 lm, 3.000 K



627514000



**Deckenleuchte · Ceiling lamp**  
 Ø 60 cm, ↓ 12 cm  
 incl. SMD-LED, 40 W  
 3.500 lm, 3.000 K





627516000



# NAGANO

Acryl, Starlight-Effekt · acryl, starlight effect · acryl, effet étoile · acryl, sterlicht effect · acrílico, efecto de la luz · acrilico, effetto di stelle · acrilic, efect lumina stelelor · akryyli, starlight vaikutus · akryl, efekt starlight

 **Lichtfarbe stufenlos einstellbar · Light color infinitely variable**

 **Memory Funktion · Memory function**



3.000 K

5.500 K

**Deckenleuchte · Ceiling lamp**  
 Ø 80 cm, ↓ 10,8 cm  
 incl. SMD-LED, max. 72 W  
 max. 8.500 lm, 3.000 - 5.500 K



677718000





## GONZALO

Kunststoff, Weiß oder titanfarbig · plastic, white or titan ·  
 plastique, blanc ou titane · kunststof, wit of titaan · plástico, blanco o titán ·  
 plastica, bianco o titano · plastic, alb sau titaniu · muovi, valkoinen tai titaani ·  
 plastik, biały lub tytanowy



Deckenleuchte · Ceiling lamp  
 Ø 29 cm, ↑ 8 cm  
 incl. SMD-LED, 9 W  
 900 lm, 3.000 K



626510987



Deckenleuchte · Ceiling lamp  
 Ø 34 cm, ↑ 9 cm  
 incl. SMD-LED, 12 W  
 1.050 lm, 3.000 K



626511287



Deckenleuchte · Ceiling lamp  
 Ø 42 cm, ↑ 10 cm  
 incl. SMD-LED, 25 W  
 2.300 lm, 3.000 K



626512587

## CESAR

Chrom, Acryl mit Kristalleffekt · chrome, broken glass optic ·  
 chrome, optique verre pilé · chroom, Gebroken glas optiek · cromo, Efecto cristal roto ·  
 cromo, effetto ottico vetro rotto · crom, aspect de sticla sparta · kromi, lasi efekti optiikka · chrom, Optyczne rozbite szkło

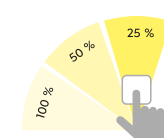

SWITCH DIMMER



Deckenleuchte · Ceiling lamp  
 Ø 26 cm, ↑ 3 cm  
 incl. SMD-LED, 13 W  
 1.500 lm, 3.000 K



656411506



Deckenleuchte · Ceiling lamp  
 Ø 40 cm, ↑ 3 cm  
 incl. SMD-LED, 22 W  
 2.700 lm, 3.000 K



656412406



Deckenleuchte · Ceiling lamp  
 ↔ 30 x 30 cm, ↑ 3 cm  
 incl. SMD-LED, 16 W  
 1.900 lm, 3.000 K



656511806



Deckenleuchte · Ceiling lamp  
 ↔ 40 x 40 cm, ↑ 3 cm  
 incl. SMD-LED, 22 W  
 2.700 lm, 3.000 K



656512006









# MOONY

Stoffschild · fabric shade · abat-jour tissu · Stoffen kap · Pantalla de tela · paralume in tessuto · abajur textil · kangas varjostin · Klosz z materiału

-  **01** | Weiß · white
-  **45** | Pastellblau · pastel blue
-  **94** | Pastellrosa · pastel pink

Empfohlen:  
recommended: LED E27, 6 W  
470 lm, 3.000 K



**987-60**

Deckenleuchte · Ceiling lamp  
Ø 40 cm, ↑ 20,5 cm  
excl. 3 x E27, max. 10 W



**602300301**  
**602300345**  
**602300394**



# CURVA

Nickel matt, Glas matt · nickel mat, mat glass · nickel mat, verre mat · nikkil mat, mat glas · níquel mate, vidrio mate · nichel opaco, vetro sabbaiato · nichel mat, sticla mata · harjattu teräs, mattalasi · nikiel mat, szkło matowane

Empfohlen:  
recommended: LED E14, 4,9 W  
470 lm, 3.000 K



**983-60**



Deckenleuchte · Ceiling lamp  
↔ 50 x 20 cm, ↑ 27 cm  
excl. 3 x E14, max. 40 W



**605600307**



Deckenleuchte · Ceiling lamp  
↔ 72 x 28 cm, ↑ 27 cm  
excl. 5 x E14, max. 40 W



**605600507**





## QUINTA

rostfarbig, Glas alabasterfarbig · rusty, alabaster-coloured glass ·  
rouille, verre couleur albâtre · roestkleur, albastkleurig glas · óxido, vidrio de color alabastro ·  
ruggine, vetro colore alabastro · ruginiu, sticla culoare alabastru · rustiikki, lasi alabasteri väri · miedz, szkło alabaster kolor



Deckenleuchte · Ceiling lamp  
Ø 33 cm, ↑ 20 cm  
excl. 2 x E27, max. 42 W



608100224



Deckenleuchte · Ceiling lamp  
Ø 42 cm, ↑ 32 cm  
excl. 3 x E27, max. 60 W



608100324



## REPOSA

rostfarbig antik, Glas matt · antique rust, mat glass ·  
rouille antique, verre mat · roestkleur antiek, mat glas · oxido, vidrio mate ·  
ruggine anticato, vetro sabbaiato · ruginiu antic, sticla mata · rustiikki, mattalasi · antyczny rdzawy, szkło matowane



Deckenleuchte · Ceiling lamp  
Ø 80 cm, ↑ 10,5 cm  
incl. 15 x SMD-LED, 1,1 W  
15 x 115 lm, 3.000 K



622811528





# SAESONS

Holz naturbelassen, Stoff · wood natural finish, fabric · bois finition naturelle, tissu · hout natuurlijke afwerking, textiel · maderas acabado natural, tela · di legno finitura naturale, tessuto · lemn finisaj natural, textil · puu luonnollinen viimeistely, tekstiili · drewno naturalne wykończenie, tkanina



Deckenleuchte · Ceiling lamp  
 Ø 30 cm, ↓ 22 cm  
 excl. 2 x E14, max. 40 W



611500201  
 611500202



Deckenleuchte · Ceiling lamp  
 Ø 50 cm, ↓ 22 cm  
 excl. 3 x E27, max. 40 W



611500301  
 611500302







## PALI

Holz, Glas satiniert · wood, satinated glass ·  
bois, Verre satiné · hout, Gesatineerd glas · madera, Vidrio satinado ·  
di legno, Vetro satinato · lemn, Sticla satinata · puu, Satinoitu lasi ·  
drewno, Szko satynowe



Wandleuchte · Wall lamp  
↑ 25 x 25 cm, ↗ 9 cm  
excl. 1 x E27, max. 40 W



212600130  
212600156



Wandleuchte · Wall lamp  
↑ 45 x 14 cm, ↗ 10,5 cm  
excl. 2 x E27, max. 40 W



212600230  
212600256



Deckenleuchte · Ceiling lamp  
Ø 32 cm, ↓ 9 cm  
excl. 2 x E27, max. 40 W



612600230  
612600256



30 | Holz naturbelassen · wood natural finish

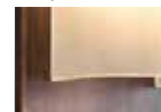

56 | Holz dunkel · old wood



# CLEO

Metall, goldfarbig · metal, gold ·  
metale, or · metaal, goud · metal, oro · metallo, oro ·  
metal, aur · metalli, kultaa · metal, zlota

Empfohlen:  
recommended: LED GU10, 4,5 W  
345 lm, 3.000 K



956-55



Wandleuchte · Wall lamp  
↑ 15 x 8 cm, ↗ 8 cm  
excl. 2 x GU10, max. 35 W

Wandleuchte · Wall lamp  
↑ 16,5 x 6 cm, ↗ 10 cm  
excl. 2 x GU10, max. 35 W



206500279

206400279

# AURORA

Metall, goldfarbig · metal, gold ·  
metale, or · metaal, goud · metal, oro · metallo, oro ·  
metal, aur · metalli, kultaa · metal, zlota



Wandleuchte · Wall lamp  
↗ 12 cm, Ø 20 cm  
incl. 1 x SMD-LED, 3,1 W, 310 lm  
incl. 1 x SMD-LED, 3 W, 200 lm  
3.000 K



223810279



# CHIROS

Metall, goldfarbig, Glas satiniert · metal, gold, satinated glass ·  
metale, or, verre satiné · metaal, goud, gesatineerd glas · metal, oro, vidrio satinado ·  
metallo, oro, vetro satinato · metal, aur, sticla satinata · metalli, kultaa, satinoitu lasi ·  
metal, złota, szkło satynowe



Wandleuchte · Wall lamp  
Ø 22 cm, ↗ 6,5 cm  
incl. 1 x SMD-LED, 8 W  
700 lm, 3.000 K



224110179



Deckenleuchte · Ceiling lamp  
Ø 32 cm, ↓ 6 cm  
incl. 1 x SMD-LED, 12 W, 1.280 lm  
incl. 1 x SMD-LED, 3,5 W, 350 lm  
3.000 K

624110279





# MARRIOT

Nickel matt oder goldfarbig, Stoffschirm · nickel mat or gold, fabric shade · nickel mat ou or, abat-jour tissu · nikkel mat of goud, Stoffen kap · níquel mate o oro, Pantalla de tela · nichel opaco o oro, paralume in tessuto · nichel mat sau aur, abajur textil · harjattu teräs tai kultaa, kangas varjostin · nikiel mat lub złota, Klosz z materiału

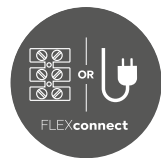

Seite/page 632

Wandleuchte · Wall lamp  
↓ 30,8 x 14 cm, ↗ 17,6 cm  
incl. 1 x SMD-LED, 3,1 W  
310 lm, 3.000 K  
excl. 1 x E14, max. 40 W



271470207  
271470279

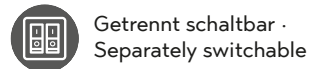

07 | Nickel matt · nickel mat



79 | goldfarbig · gold



# JORDAN

Nickel matt, Weiß matt oder Schwarz matt, Acryl · nickel mat, white mat or black mat, acryl · nickel mat, blanc mat ou noir mat, acryl · nikkel mat, wit mat of mat zwart, acryl · níquel mate, estera blanca o estera negra, acrílico · nichel opaco, bianco opaco o nero opaco, acrilico · nichel mat, alb mat sau negru mat, acrilic · harjattu teräs, mattavalkoinen tai mattamusta, akryyli · nikiel mat, biały mat lub czarny mat, akryl

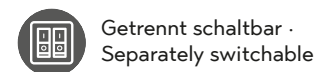

07 | Nickel matt · nickel mat



31 | Weiß matt · white mat



32 | Schwarz matt · black mat



Seite/page 632

Wandleuchte · Wall lamp  
Ø 15 cm, ↗ 12 cm  
incl. 1 x SMD-LED, 5 W  
550 lm, 3.000 K  
incl. 1 x SMD-LED, 2 W  
200 lm, 3.000 K



229210207  
229210231  
229210232



# MARIO

Metall, Weiß matt oder Schwarz matt · metal, white mat or black mat ·  
metale, blanc mat ou noir mat · metaal, wit mat of mat zwart ·  
metal, estera blanca o estera negra · metallo, bianco opaco o nero  
opaco · metal, alb mat sau negru mat · metalli, valkoinen matto  
tai musta matto · metal, biały mat lub czarny mat



Getrennt schaltbar ·  
Separately switchable

## Wandleuchte · Wall lamp

Ø 16 cm, ∅ 10,5 cm  
incl. 1 x SMD-LED, 6 W  
600 lm, 3.000 K  
incl. 1 x SMD-LED, 2,3 W  
200 lm, 3.000 K



222370231 | Weiß matt · white mat  
222370232 | Schwarz matt · black mat



Seite/page 632



# LUIGI

Metall, Weiß matt oder Schwarz matt · metal, white mat or black mat ·  
metale, blanc mat ou noir mat · metaal, wit mat of mat zwart ·  
metal, estera blanca o estera negra · metallo, bianco opaco o nero  
opaco · metal, alb mat sau negru mat · metalli, valkoinen matto  
tai musta matto · metal, biały mat lub czarny mat



Getrennt schaltbar ·  
Separately switchable

## Wandleuchte · Wall lamp

↓ 20 x 13,5 cm, ∅ 11 cm  
incl. 1 x SMD-LED, 5 W  
500 lm, 3.000 K  
incl. 1 x SMD-LED, 2,3 W  
200 lm, 3.000 K



222270231 | Weiß matt · white mat  
222270232 | Schwarz matt · black mat

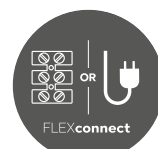

Seite/page 632



# ELEMENT

Metall, Weiß matt oder Schwarz matt · metal, white mat or black mat ·  
metale, blanc mat ou noir mat · metaal, wit mat of mat zwart · metal, estera blanca o estera negra ·  
metallo, bianco opaco o nero opaco · metal, alb mat sau negru mat · metalli, valkoinen matto tai musta matto ·  
metal, biały mat lub czarny mat



USB Anschluss mit Ladefunktion ·  
Recharging USB connection



Getrennt schaltbar ·  
Separately switchable



indirekte Beleuchtung ·  
indirect lighting

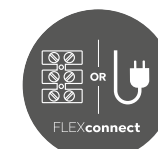

Seite/page 632



## Wandleuchte · Wall lamp

↓ 20 x 16 cm, ∅ 14 cm  
incl. 1 x SMD-LED, 3 W  
220 lm, 3.000 K  
incl. 2 x SMD, 1,5 W  
2 x 150 lm, 3.000 K



222570231 | Weiß matt · white mat  
222570232 | Schwarz matt · black mat





# ANDREUS

Metall, weiß matt oder schwarz matt, Stoffschirm · metal, white mat or black mat, fabric shade ·  
metale, blanc mat ou noir mat, abat-jour tissu · metaal, wit mat of mat zwart, Stoffen kap ·  
metal, estera blanca o estera negra, Pantalla de tela · metallo, bianco opaco o nero opaco,  
paralume in tessuto · metal, alb mat sau negru mat, abajur textil · metalli, valkoinen matto  
tai musta matto, kangas varjostin · metal, biały mat lub czarny mat, Klosz z materiału

Empfohlen:  
recommended: Filament LED E14, 4 W  
400 lm, 2.700 K



989-479

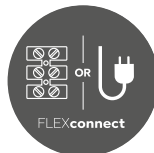

Seite/page 632



Wandleuchte · Wall lamp  
Ø 15 cm, ↑ 26,5 cm, ↗ 19,5 cm  
excl. 1 x E14, max. 40 W



207500179 | goldfarbig, Schwarz matt · gold, black mat  
207500189 | silberfarbig, Weiß mat · silver, white mat



# WANDA

Metall, Kunststoff · metal, plastic ·  
metale, plastique · metaal, kunststof · metal, plástico ·  
metallo, plastica · metal, plastic · metalli, muovi · metal, plastik

Empfohlen:  
recommended: LED GU10, 3 W  
250 lm, 3.000 K



956-30

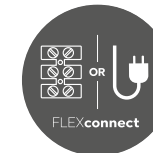

Seite/page 632



Wandleuchte · Wall lamp  
↑ 23,5 cm, ↔ 8,5 cm, ↗ 22 cm  
excl. 1 x GU10, max. 35 W



202670107 | Nickel matt · nickel mat  
202670108 | Messing matt · brass mat  
202670131 | Weiß matt · white mat  
202670132 | Schwarz matt · black mat



# BALDO

Metall, schwarz matt · metal, black mat ·  
metale, noir mat · metaal, mat zwart · metal, estera negra ·  
metallo, nero opaco · metal, negru mat · metalli, mattamusta ·  
metal, czarny mat

Empfohlen:  
recommended: Filament LED E27, 7 W  
806 lm, 2.700 K



987-6810



Wandleuchte · Wall lamp  
↔ 28 cm, ↑ 28,3 cm, ↗ max. 150 cm,  
excl. 1 x E27, max. 40 W



200600132

# LINE

Metall, schwarz matt · metal, black mat ·  
metale, noir mat · metaal, mat zwart · metal, estera negra ·  
metallo, nero opaco · metal, negru mat · metalli, mattamusta ·  
metal, czarny mat

Empfohlen:  
recommended: Filament LED E27, 7 W  
806 lm, 3.000 K



988-600



Wandleuchte · Wall lamp  
↔ 5,5 cm, ↑ 25 cm, ↗ max. 150 cm  
excl. 1 x E27, max. 40 W



200200132

# BOLDER

Metall, schwarz matt · metal, black mat ·  
metale, noir mat · metaal, mat zwart · metal, estera negra ·  
metallo, nero opaco · metal, negru mat · metalli, mattamusta ·  
metal, czarny mat

Empfohlen:  
recommended: Filament LED E27, 8 W  
806 lm, 2.700 K



985-6810

Wandleuchte · Wall lamp  
↔ 35 cm, ↑ 29 cm, ↗ max. 150 cm  
excl. 1 x E27, max. 40 W



200300132





## CUADRO

Altmessing oder Nickel matt · old brass or nickel mat ·  
 laiton fumé ou nickel mat · oud brons of nikkel mat · bronce viejo o níquel mate ·  
 ottone invecchiato o nichel opaco · bronz antic sau nichel mat ·  
 antiikkimessinki tai harjattu teräs · patyna lub nikiel mat

Wandleuchte · Wall lamp  
 ↔ 48 x 10,5 cm, √ 10 cm  
 incl. 1 x SMD-LED, 8 W  
 900 lm, 3.000 K

225210104 | Altmessing · old brass  
 225210107 | Nickel matt · nickel mat



## CURTIS

Altmessing, Nickel matt, Messing matt oder Schwarz matt · old brass, nickel mat, brass mat or black mat ·  
 Laiton fumé, Nickel mat, Laiton mat ou Noir mat · Oud brons, Nikkel mat, Messing mat of Mat zwart ·  
 Bronce viejo, Níquel mate, Bronce mate o Estera negra · Ottone invecchiato, Nichel opaco, Ottone satinato o Nero opaco ·  
 Bronz antic, Nichel mat, Bronz mat sau Negru mat · Antiikkimessinki, Harjattu teräs, Mattamessinki tai mattamusta ·  
 Patyna, Nikiel mat, Mosiądz mat lub Czarny mat

 Integrierter Dimmer ·  
 Integrated dimmer

04 | Altmessing ·  
 old brass



07 | Nickel matt ·  
 nickel mat



08 | Messing matt ·  
 brass mat



32 | Schwarz matt ·  
 black mat



Wandleuchte · Wall lamp  
 ↔ 18 cm, √ max. 35 cm  
 incl. SMD-LED, 4 W  
 380 lm, 3.000 K



279770104  
 279770107  
 279770108  
 279770132







Wandleuchte · Wall lamp  
 ↔ 12 x 12 cm, √ 10 cm  
 incl. SMD-LED, 4,3 W  
 400 lm, 3.000 K



224810131  
 224810132  
 224810167

# ARINO

Metall, Holz · metal, wood ·  
 metale, bois · metaal, hout · metal, madera ·  
 metallo, di legno · metal, lemn · metalli, puu · metal, drewno

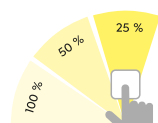

SWITCH DIMMER



31 | Weiß matt · white mat



32 | Schwarz matt · black matt



67 | Nickel antik · nickel antique



Wandleuchte · Wall lamp  
 ↔ 35,2 x 12 cm, √ 10 cm  
 incl. SMD-LED, 13,5 W  
 1.500 lm, 3.000 K



224819131  
 224819132  
 224819167

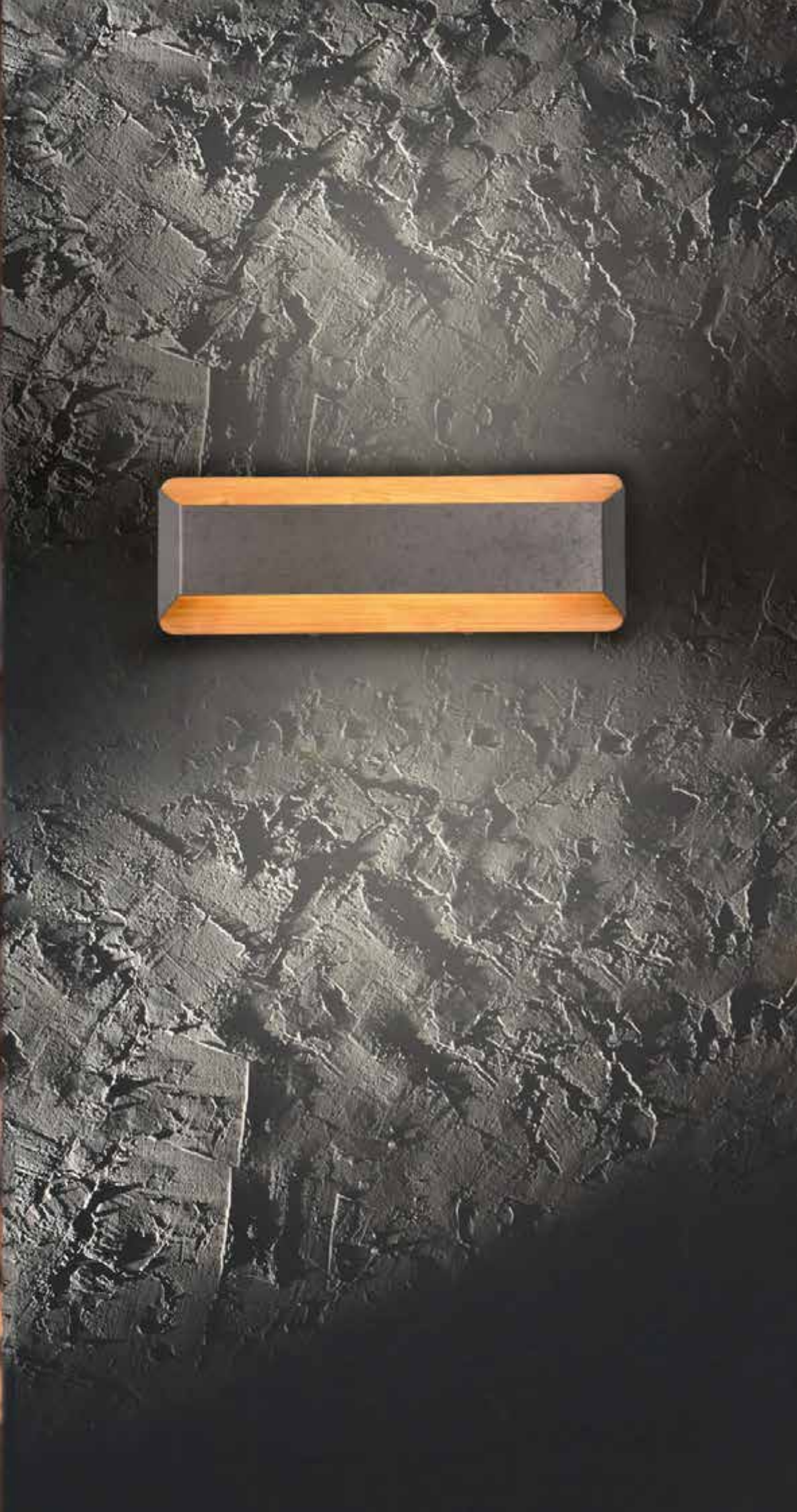





# LACAPO

Metall · metal ·  
metale · metaal · metallo · metal · metalli · metal

Wandleuchte · Wall lamp  
↔ 10,5 cm, ↑ 6 cm, ↗ 15 cm  
incl. SMD-LED, 4,3 W  
430 lm, 3.000 K



223410131  
223410132



31 | Weiß matt · white mat



32 | Schwarz matt · black mat



# LOUIS

Metall · metal ·  
metale · metaal · metallo · metal · metalli · metal · metal

Wandleuchte · Wall lamp  
↑ 10 x 10 cm, ↗ 10 cm  
incl. 1 x OSRAM-LED, 4,3 W  
430 lm, 3.000 K



223310105  
223310131  
223310132



05 | Aluminium gebürstet · brushed aluminium



31 | Weiß matt · white mat



32 | Schwarz matt · black mat





# MIGUEL

Metall, Weiß matt oder Schwarz matt · metal, white mat or black mat ·  
 metale, blanc mat ou noir mat · metaal, wit mat of mat zwart · metal, estera blanca o estera negra ·  
 metallo, bianco opaco o nero opaco · metal, alb mat sau negru mat · metalli, valkoinen matto tai musta matto · metal,  
 biały mat lub czarny mat

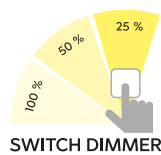

**31** | Weiß matt · white mat



**32** | Schwarz matt · black mat

**Wandleuchte · Wall lamp**  
 ↔ 20,5 x 16,5 cm, √ 8,3 cm  
 incl. SMD-LED, 2 x 6 W  
 2 x 600 lm, 3.000 K



224910231  
 224910232



# MELVIN

Metall, Schwarz matt oder Nickel antik · metal, black mat or nickel antique ·  
 metale, noir mat ou nickel antique · metaal, mat zwart of antiek nikkel ·  
 metal, estera negra o níquel antiguo · metallo, nero opaco o nickel anticato ·  
 metal, negru mat sau nichel antic · metalli, mattamusta tai antiikkiteräs ·  
 metal, czarny mat lub aikiel antyczny

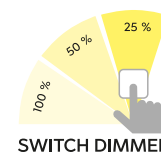

**32** | Schwarz matt · black mat

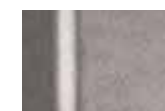

**67** | Nickel antik · nickel antique

**Wandleuchte · Wall lamp**  
 † 8,5 x 11 cm, √ 10 cm  
 incl. OSRAM-LED, 4,3 W  
 430 lm, 3.000 K



223910132  
 223910167



# WALES

Nickel matt · nickel mat ·  
nickel mat · nikkel mat · níquel mate ·  
nichel opaco · nichel mat · harjattu teräs · nikiel mat



396

Wandleuchte · Wall lamp  
↔ 9 cm, ↑ 9 cm, ∠ 5,8 cm  
incl. 2 x SMD-LED, 3,1 W  
2 x 310 lm, 3.000 K



225510207

# CUBE

Beton · concrete ·  
béton · beton · hormigón ·  
cemento · beton · betoni · beton

Empfohlen:  
recommended: LED GU10, 5 W  
400 lm, 3.000 K



956-55



Wandleuchte · Wall lamp  
↑ 15 x 10 cm, ∠ 9 cm  
excl. 2 x GU10, max. 35 W



206600278



# ZORRO

Metall, Weiß matt oder Schwarz matt · metal, white mat or black mat ·  
metale, blanc mat ou noir mat · metaal, wit mat of mat zwart · metal, estera blanca o estera negra ·  
metallo, bianco opaco o nero opaco · metal, alb mat sau negru mat · metalli, valkoinen matto tai musta matto ·  
metal, biały mat lub czarny mat



31 | Weiß matt · white mat



32 | Schwarz matt · black mat



Wandleuchte · Wall lamp  
↔ 18 x 14,5 cm, ∠ 6,5 cm  
incl. 1 x SMD-LED, 6,5 W  
700 lm, 3.000 K

223210131  
223210132

397



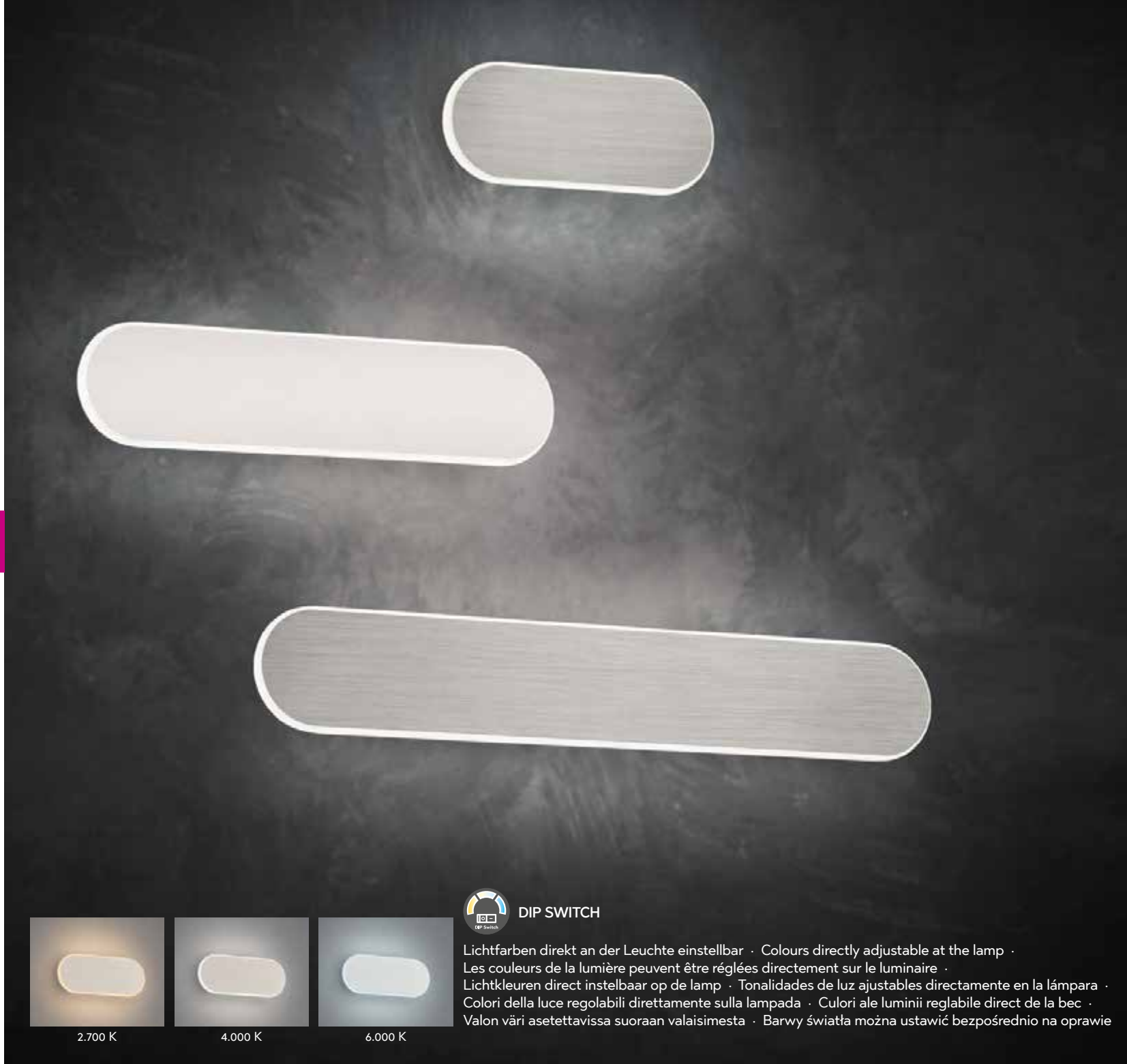

DIP SWITCH

Lichtfarben direkt an der Leuchte einstellbar · Colours directly adjustable at the lamp ·  
 Les couleurs de la lumière peuvent être réglées directement sur le luminaire ·  
 Lichtkleuren direct instelbaar op de lamp · Tonalidades de luz ajustables directamente en la lámpara ·  
 Colori della luce regolabili direttamente sulla lampada · Colori ale luminii reglabile direct de la bec ·  
 Valon väri asetettävissa suoraan valaisimesta · Barwy światła można ustawić bezpośrednio na oprawie



2.700 K      4.000 K      6.000 K



# CARLO

Metall, Nickel matt oder Weiß matt · metal, nickel mat or white mat ·  
 metale, nickel mat ou blanc mat · metaal, nikkel mat of wit mat · metal, níquel mate o estera blanca · metallo, nichel opaco o bianco opaco ·  
 metal, nichel mat sau alb mat · metalli, harjattu teräs tai mattavalkoinen · metal, nikiel mat lub biały mat

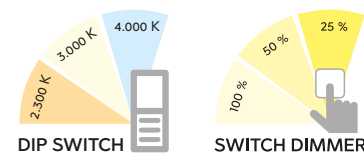

-  **07** | Nickel matt · nickel mat
-  **31** | Weiß matt · white mat



**Wandleuchte · Wall lamp**  
 ↔ 20 x 8 cm, √ 4,8 cm  
 incl. SMD-LED, 8,5 W  
 850 lm, 2.700 + 4.000 + 6.000 K



**225271007**  
**225271031**



**Wandleuchte · Wall lamp**  
 ↔ 35 x 8 cm, √ 4,8 cm  
 incl. SMD-LED, 14 W  
 1.400 lm, 2.700 + 4.000 + 6.000 K



**225271507**  
**225271531**



**Wandleuchte · Wall lamp**  
 ↔ 50 x 8 cm, √ 4,8 cm  
 incl. SMD-LED, 18 W  
 1.800 lm, 2.700 + 4.000 + 6.000 K



**225272007**  
**225272031**

# CONCHA

rostfarbig, Weiß matt oder Anthrazit · rusty, white mat or anthracite ·  
 rouille, blanc mat ou antracite · roestkleur, wit mat of antraciet · óxido, estera blanca o antracita ·  
 ruggine, bianco opaco o antracite · ruginiu, alb mat sau antracit · rustiikki, mattavalkoinen tai antrasiitti ·  
 miedź, biały mat lub antracyt

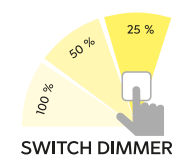

**24** | rostfarbig · rusty

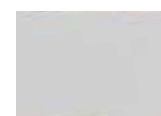

**31** | Weiß matt · white mat



**42** | Anthrazit · anthracite



**Wandleuchte · Wall lamp**  
 ↔ 28 x 8 cm, √ 4,5 cm  
 incl. 2 x SMD-LED, 6 W  
 2 x 600 lm, 3.000 K



**225172924**  
**225172931**  
**225172942**



**Wandleuchte · Wall lamp**  
 ↔ 47 x 8 cm, √ 4,5 cm  
 incl. 2 x SMD-LED, 9 W  
 2 x 900 lm, 3.000 K



**225174724**  
**225174731**  
**225174742**



# PLATON

Aluminium gebürstet, Acryl · brushed aluminium, acryl · aluminium balayé, acryl · geborsteld aluminium, acryl · aluminio pulido, acrílico · alluminio spazzolato, acrilico · aluminiu lucios, acrilic · harjattu alumiini, akryyli · aluminium szczotkowane, akryl



Wandleuchte · Wall lamp  
↔ 13 x 18 cm, ∟ 9 cm  
incl. 1 x SMD-LED, 4,3 W  
430 lm, 3.000 K

Wandleuchte · Wall lamp  
↔ 30 x 18 cm, ∟ 11 cm  
incl. 2 x SMD-LED, 4,3 W  
2 x 430 lm, 3.000 K



274670105

274670205



# TRINITY

Aluminium gebürstet, Acryl · brushed aluminium, acryl · aluminium balayé, acryl · geborsteld aluminium, acryl · aluminio pulido, acrílico · alluminio spazzolato, acrilico · aluminiu lucios, acrilic · harjattu alumiini, akryyli · aluminium szczotkowane, akryl

 Lichtfarbe einstellbar · Adjustable light color



3.000 K

4.000 K

5.500 K

Wandleuchte · Wall lamp  
↑ 30 x 20 cm, ∟ 7 cm  
incl. SMD-LED, 10 W  
800 lm, 3.000+4.000+5.500 K



274813005



# ADRIANO

Aluminium gebürstet oder Weiß · brushed aluminium or white · aluminium balayé ou blanc · geborsteld aluminium of wit · aluminio pulido o blanco · alluminio spazzolato o bianco · aluminiu lucios sau alb · harjattu alumiini tai valkoinen · aluminium szczotkowane lub biały



01 | Weiß · white



05 | Aluminium gebürstet · brushed aluminium

Wandleuchte · Wall lamp  
↔ 30 x 6 cm, ∟ 8 cm  
incl. 2 x SMD-LED, 3,1 W  
2 x 310 lm, 3.000 K



220810201  
220810205





# MARTA

Chrom, Glas · chrome, glass ·  
chrome, verre · chroom, glas · cromo, vidrio ·  
cromo, vetro · crom, sticla · kromi, lasi · chrom, szkło

Empfohlen:  
recommended: LED E14, 3,5 W  
320 lm, 3.000 K



989-40



Wandleuchte · Wall lamp  
↔ 20 x 20 cm, ↗ 8,5 cm  
excl. 1 x E14, max. 40 W



2523011-01

# DIVO

Chrom, Glas · chrome, glass ·  
chrome, verre · chroom, glas · cromo, vidrio ·  
cromo, vetro · crom, sticla · kromi, lasi · chrom, szkło

Empfohlen:  
recommended: LED E14, 3,5 W  
320 lm, 3.000 K



989-40



Wandleuchte · Wall lamp  
↔ 20 x 20 cm, ↗ 7,5 cm  
excl. 1 x E14, max. 40 W



2522011-06

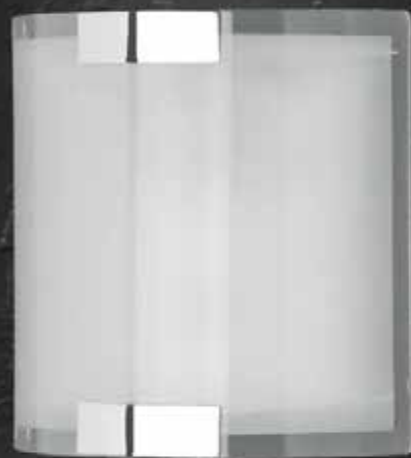

# TOULON

Metall, Glas matt · metal, mat glass ·  
metale, verre mat · metaal, mat glas · metal, vidrio mate · metallo, vetro sabbaiato ·  
metal, sticla mata · metalli, mattalasi · metal, szkło matowane

Empfohlen:  
recommended: LED E27, 7 W  
560 lm, 3.000 K



988-700



Wandleuchte · Wall lamp  
↔ 13 cm, ↓ 44 cm, ↗ 13 cm  
excl. 1 x E27, max. 60 W



204700101





# CONO

Nickel matt, Glas matt · nickel mat, mat glass ·  
nickel mat, verre mat · nikkel mat, mat glas ·  
níquel mate, vidrio mate · nichel opaco, vetro sabbiato ·  
nichel mat, sticla mata · harjattu teräs, mattalasi ·  
nikiel mat, szkło matowane

Empfohlen:  
recommended: LED E14, 3,5 W  
320 lm, 3.000 K



989-40



404

Wandleuchte · Wall lamp  
↑ 35 cm, ↔ 10 cm, ↗ 15 cm  
excl. 1 x E14, max. 60 W



2502211-07

# CAMPO

rostfarbig, Scavo glas · rusty, scavo glass ·  
rouille, verre scavo · roestkleur, scavo glas ·  
óxido, vidrio scavo · ruggine, vetro scavo ·  
ruginiu, sticla scavo · rustiikki, scavo-lasi ·  
miedź, szkło scavo

Empfohlen:  
recommended: Filament LED E14, 4 W  
470 lm, 2.700 K



989-400



Wandleuchte · Wall lamp  
↑ 44 cm, ↔ 12 cm, ↗ 16 cm  
excl. 1 x E14, max. 40 W



200970124

# PURA

Metall, Glas · metal, glass ·  
metale, verre · metaal, glas · metal, vidrio ·  
metallo, vetro · metal, sticla · metalli, lasi · metal, szkło

Empfohlen:  
recommended: Filament LED E27, 7 W  
806 lm, 2.700 K



987-6810



04 | Altmessing · old brass



07 | Nickel matt · nickel mat



Wandleuchte · Wall lamp  
↑ 20 cm, ↔ 20 cm, ↗ 7,5 cm  
excl. 1 x E27, max. 40 W



212700104  
212700107



Wandleuchte · Wall lamp  
↑ 40 cm, ↔ 20 cm, ↗ 7,5 cm  
excl. 2 x E27, max. 40 W



212700204  
212700207

405





# ADRIAN

Glas alabasterfarbig · alabaster-coloured glass · verre couleur albâtre · albastkleurig glas · vidrio de color alabastro · vetro colore alabastro · sticla culoare alabastru · lasi alabasteri väri · szkło alabaster kolor



Deckenleuchte · Ceiling lamp  
Ø 30 cm, ↓ 9 cm  
excl. 1 x E27, max. 40 W

Deckenleuchte · Ceiling lamp  
Ø 40 cm, ↓ 10 cm  
excl. 2 x E27, max. 40 W



6105011-01



6105021-01

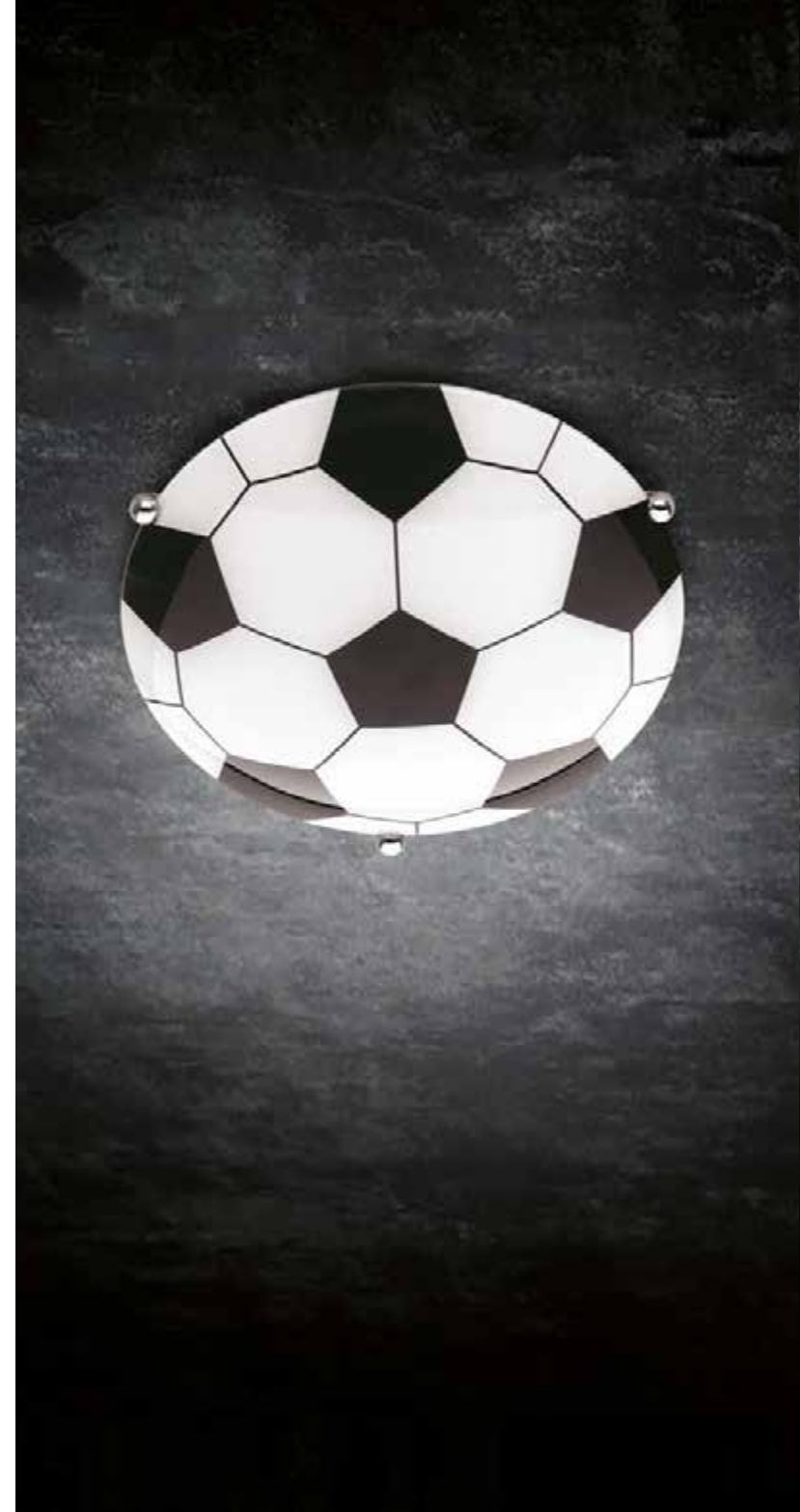

# CHICO

Glas · glass · verre · glas · vidrio · vetro · sticla · lasi · szkło



Deckenleuchte · Ceiling lamp  
Ø 30 cm, ↓ 9 cm  
excl. 1 x E27, max. 60 W



6160011-00



# LANA

Glas Weiß matt oder alabasterfarbig · glass white mat or alabaster coloured · verre blanc mat ou couleur albâtre · glas wit mat of albastkleurig · vidrio estera blanca o Color alabastro · vetro bianco opaco o color alabastro · sticla alb mat sau Colorat în alabastru · lasi mattaval-koinen tai alabasterin värinen · szkło biały mat lub kolor alabastrowy



Deckenleuchte · Ceiling lamp  
Ø 25 cm, ↓ 9 cm  
excl. 1 x E27, max. 40 W

Deckenleuchte · Ceiling lamp  
Ø 25 cm, ↓ 9 cm  
excl. 1 x E27, max. 40 W



6196011-01



6196011-07



# PRIMO

Metall, Glas · metal, glass · metale, verre · metaal, glas · metal, vidrio · metallo, vetro · metal, sticla · metalli, lasi · metal, szkło



01 | Weiß · white



07 | Nickel matt · nickel mat

Deckenleuchte · Ceiling lamp  
Ø 30 cm, ↓ 7,5 cm  
excl. 1 x E27, max. 60 W



6101011-01  
6101011-07



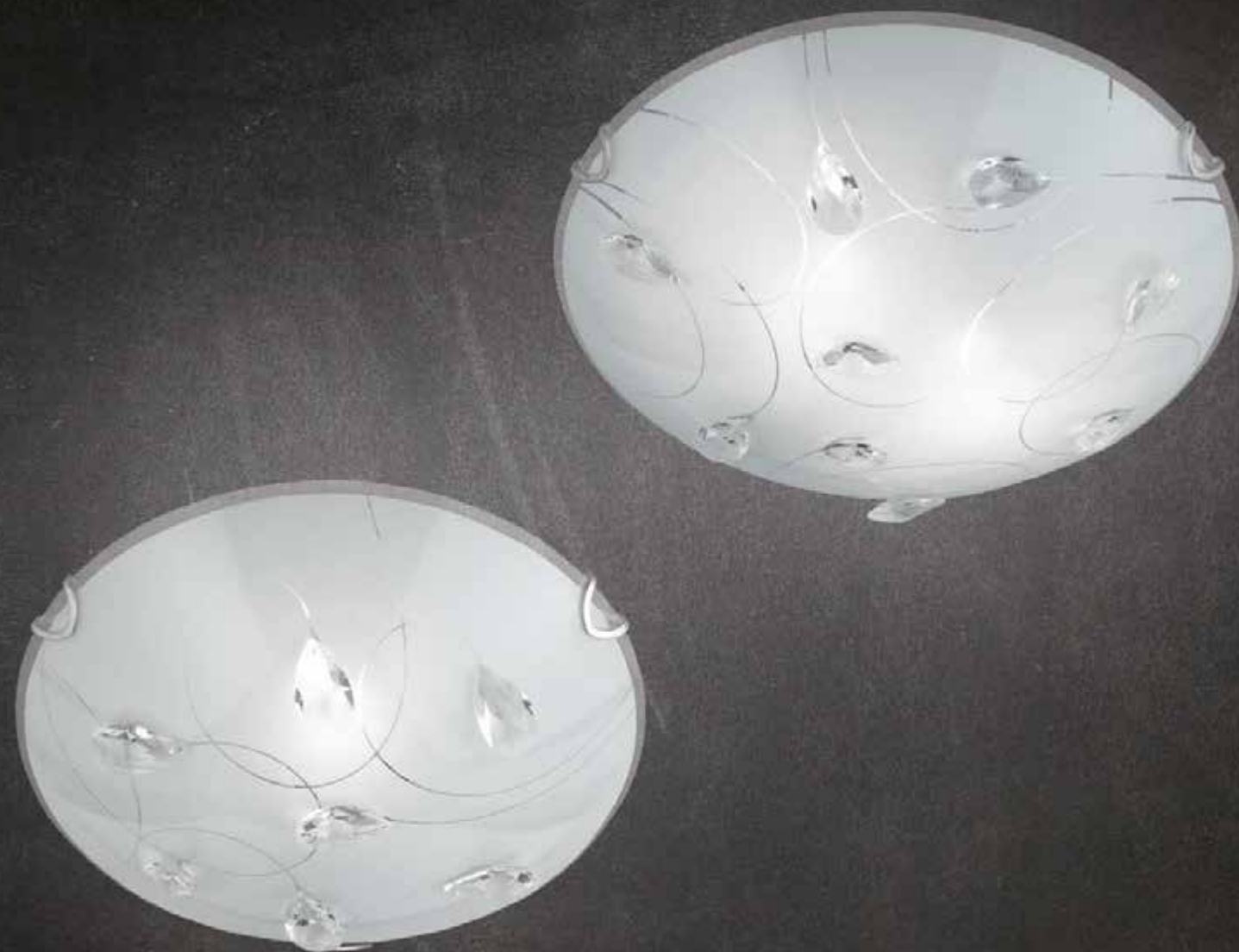

## CARBONADO

Dekorglas · glas decorated ·  
verre décoré · decoratief glas · vidrio decorado ·  
vetro decorato · sticla decorativa · ornamentilasi · szkło dekoracyjne



Wandleuchte · Wall lamp  
↔ 20 x 22 cm, ↑ 10 cm  
excl. 1 x E14, max. 40 W



202400106



Deckenleuchte · Ceiling lamp  
Ø 25 cm, ↑ 9,5 cm  
excl. 1 x E27, max. 40 W



602400106



Deckenleuchte · Ceiling lamp  
Ø 30 cm, ↑ 10,5 cm  
excl. 2 x E27, max. 40 W



602400206



## COLINA

Dekorglas · glas decorated ·  
verre décoré · decoratief glas · vidrio decorado ·  
vetro decorato · sticla decorativa · ornamentilasi · szkło dekoracyjne



Wandleuchte · Wall lamp  
↔ 17 cm, ↑ 23 cm, ↑ 8,5 cm  
excl. 1 x E27, max. 40 W



200400100

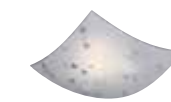

Deckenleuchte · Ceiling lamp  
↔ 30 x 30 cm, ↑ 9 cm  
excl. 1 x E27, max. 40 W



600400100



Deckenleuchte · Ceiling lamp  
↔ 40 x 40 cm, ↑ 9,5 cm  
excl. 2 x E27, max. 40 W



600400200



# LILLY

Empfohlen:  
recommended: Filament LED E27, 7 W  
680 lm, 2.700 K



988-710



Deckenleuchte · Ceiling lamp  
Ø 30 cm, ↑ 6 cm  
excl. 1 x E27, max. 40 W



603300101

Überstreichbare Gipsleuchten ·  
Gypsum lights that can be painted · Lampes en gypse à peindre ·  
overschilderbare gipslampen · Lámparas de yeso que pueden  
pintarse · Le lampade in gesso possono essere verniciate ·  
Lāmpi de ipsos, ce pot fi vopsite · Maalattava kipsivalaisin ·  
Oświetlenie gipsowe, które można pomalować

# ZAZOU

Empfohlen:  
recommended: LED GU10, 5 W  
400 lm, 3.000 K



955-50



Wandleuchte · Wall lamp  
↑ 16,5 cm, ↔ 7,5 cm, ↗ 7 cm  
excl. 2 x GU10, max. 10 W



201100201



# ROMA

Überstreichbare Gipsleuchte · Gypsum lights that can be painted ·  
Lampes en gypse à peindre · overschilderbare gipslampen ·  
Lámparas de yeso que pueden pintarse · Le lampade in gesso possono essere verniciate ·  
Lāmpi de ipsos, ce pot fi vopsite · Maalattava kipsivalaisin ·  
Oświetlenie gipsowe, które można pomalować

Empfohlen:  
recommended: LED E14, 4,9 W  
470 lm, 3.000 K



983-60



Wandleuchte · Wall lamp  
↔ 24,5 x 9,5 cm, ↗ 12 cm  
excl. 1 x E14, max. 28 W



201000101





# LAON

Nickel matt · nickel mat ·  
nickel mat · nikkel mat · níquel mate ·  
nichel opaco · nichel mat · harjattu teräs · nikiel mat

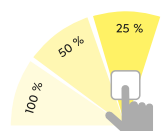

SWITCH DIMMER

Empfohlen:  
recommended: LED GU10, 4,5 W  
345 lm, 3.000 K



956-55

Steckerleuchte · Plug light

↑ 40 cm, ↔ 4,7 cm, ∠ max. 16 cm  
incl. 1 x LED GU10, 5 W  
400 lm, 3.000 K



899670107



412

# LIGARA

Kunststoff · plastic ·  
plastique · kunststof · plástico ·  
plastica · plastic · muovi · plastik

Empfohlen:  
recommended: LED E14, 3,5 W  
320 lm, 3.000 K



983-40

Steckerleuchte · Plug light

↑ 28 cm, ↔ 6,9 cm, ∠ max. 20 cm  
excl. 1 x E14, max. 40 W



8911211-07



# LEVISTO

Glas alabasterfarbig · alabaster-coloured glass ·  
verre couleur albâtre · albastkleurig glas ·  
vidrio de color alabastro · vetro colore alabastro ·  
sticla culoare alabastru · lasi alabasteri väri ·  
szkło alabaster kolor

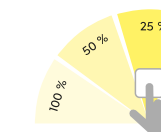

SWITCH DIMMER

Empfohlen:  
recommended: LED E14, 4,9 W  
470 lm, 3.000 K



983-66

Steckerleuchte · Plug light

↑ 40 cm, ↔ 4,7 cm, ∠ max. 22 cm  
incl. 1 x LED E14, 6 W  
470 lm, 3.000 K



891010107



413

# FRED

Glas matt · mat glass ·  
verre mat · mat glas · vidrio mate ·  
vetro sabbato · sticla mata · mattalasi · szkło matowane

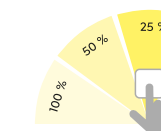

SWITCH DIMMER

Empfohlen:  
recommended: LED G9, 2,3 W  
200 lm, 3.000 K



929-220 Set 2

Steckerleuchte · Plug light

↑ 40 cm, ↔ 4,7 cm, ∠ max. 20 cm  
incl. 1 x LED G9, 3 W  
300 lm, 3.000 K



891770107





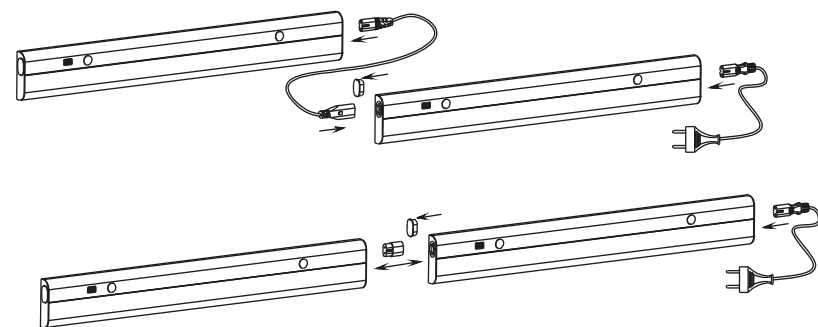
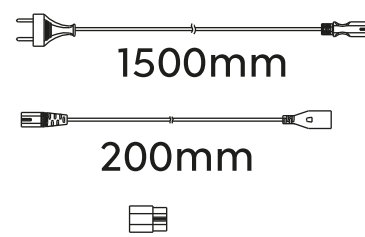

# SIMEO

Kunststoff, Weiß · plastic, white ·  
 plastique, blanc · kunststof, wit · plástico, blanco ·  
 plastica, bianco · plastic, alb · muovi, valkoinen · plastik, biały



Gestensteuerung · Gesture control ·  
 Contrôle gestuel · Gebaarbediening · Control gestual ·  
 Controllo gestuale · Control prin gesturi/miscarea mainii ·  
 Kädellä ohjattava liiketunnistin · Sterowana gestami



Unterbauleuchte · cabinet lighting  
 ↔ 52,8 x 6,8 cm, ↑ 1,8 cm  
 incl. SMD-LED, 10 W  
 850 lm, 3.000 K



273271201



Unterbauleuchte · cabinet lighting  
 ↔ 77 x 6,8 cm, ↑ 1,8 cm  
 incl. SMD-LED, 15,5 W  
 1.300 lm, 3.000 K



273271801





## ARAGON

Kunststoff, Weiß oder titanfarbig · plastic, white or titan ·  
 plastique, blanc ou titane · kunststof, wit of titaan · plástico, blanco o titán ·  
 plastica, bianco o titano · plastic, alb sau titaniu · muovi, valkoinen tai titaani ·  
 plastik, biały lub tytanowy



01 | Weiß · white

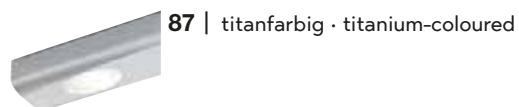

87 | titanfarbig · titanium-coloured



**Unterbauleuchte · cabinet lighting**  
 ↔ 40 x 4 cm, ↓ 2 cm  
 incl. 3 x SMD-LED, 1 W  
 3 x 80 lm, 3.000 K



273170301  
 273170387



**Unterbauleuchte · cabinet lighting**  
 ↔ 55 x 4 cm, ↓ 2 cm  
 incl. 4 x SMD-LED, 1 W  
 4 x 90 lm, 3.000 K



273170401  
 273170487



## ALINO

Kunststoff, Weiß oder titanfarbig · plastic, white or titan ·  
 plastique, blanc ou titane · kunststof, wit of titaan · plástico, blanco o titán ·  
 plastica, bianco o titano · plastic, alb sau titaniu · muovi, valkoinen tai titaani ·  
 plastik, biały lub tytanowy

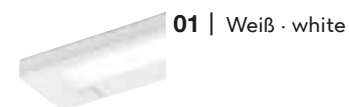

01 | Weiß · white

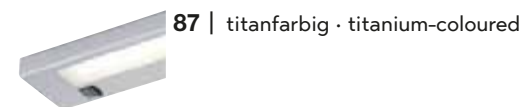

87 | titanfarbig · titanium-coloured



**Unterbauleuchte · cabinet lighting**  
 ↔ 34 x 7 cm, ↓ 2 cm  
 incl. SMD-LED, 4 W  
 350 lm, 3.000 K



272970401  
 272970487



**Unterbauleuchte · cabinet lighting**  
 ↔ 55 x 7 cm, ↓ 2 cm  
 incl. SMD-LED, 7 W  
 600 lm, 3.000 K



272970701  
 272970787





# ECCO

Nickel matt · nickel mat ·  
 nickel mat · nikkell mat · níquel mate ·  
 nichel opaco · nichel mat · harjattu teräs · nikiel mat

Unterbauleuchte · cabinet lighting  
 ↔ 12,4 x 11,5 cm, ↑ 4,3 cm  
 incl. 3 x SMD-LED, 3 W  
 3 x 200 lm, 3.000 K



273370307 Set: 3 St./3 pc.



# RAMON

Kunststoff · plastic ·  
 plastique · kunststof · plástico ·  
 plastica · plastic · muovi · plastik



Unterbauleuchte · cabinet lighting  
 ↔ 28 x 2,5 cm, ↑ 4 cm  
 incl. 1 x SMD-LED, 3,5 W  
 400 lm, 3.000 K



273070401



Unterbauleuchte · cabinet lighting  
 ↔ 51 x 2,5 cm, ↑ 4 cm  
 incl. 1 x SMD-LED, 6,5 W  
 700 lm, 3.000 K



273070701



Unterbauleuchte · cabinet lighting  
 ↔ 84 x 2,5 cm, ↑ 4 cm  
 incl. 1 x SMD-LED, 12 W  
 1.400 lm, 3.000 K



273071301



Unterbauleuchte · cabinet lighting  
 ↔ 114 x 2,5 cm, ↑ 4 cm  
 incl. 1 x SMD-LED, 16,5 W  
 1.850 lm, 3.000 K



273071801





## Tisch- & Stehleuchten

Table- & floor lamps  
 Lampes de table & lampadaires  
 Tafel- & vloerlampen  
 Sobremesas y lámparas de pie  
 Lampade da tavolo e piantane  
 Veioze si lampadare  
 Pöytä- & lattia  
 Stołowe i podłogowe



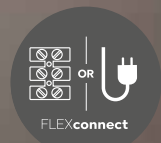

Seite/page 632



# CASSIO

Metall, Stoff · metal, fabric ·  
 metale, tissu · metaal, textiel · metal, tela ·  
 metallo, tessuto · metal, textil · metalli, tekstiili · metal, tkanina

**07** | Nickel matt · nickel mat

**08** | Messing matt · brass mat

**32** | Schwarz matt · black mat



**Wandleuchte · Wall lamp**  
 † 27,9 cm, Ø 23 cm, † 25,9 cm  
 excl. 1 x E27, max. 40 W



214470107  
 214470108  
 214470132



**Tischleuchte · Table lamp**  
 † 48 cm, Ø 28 cm  
 excl. 1 x E27, max. 40 W



514400107  
 514400108  
 514400132



**Stehleuchte · Floor lamp**  
 † 153,3 cm, Ø 50 cm  
 excl. 1 x E27, max. 40 W



414400107  
 414400108  
 414400132



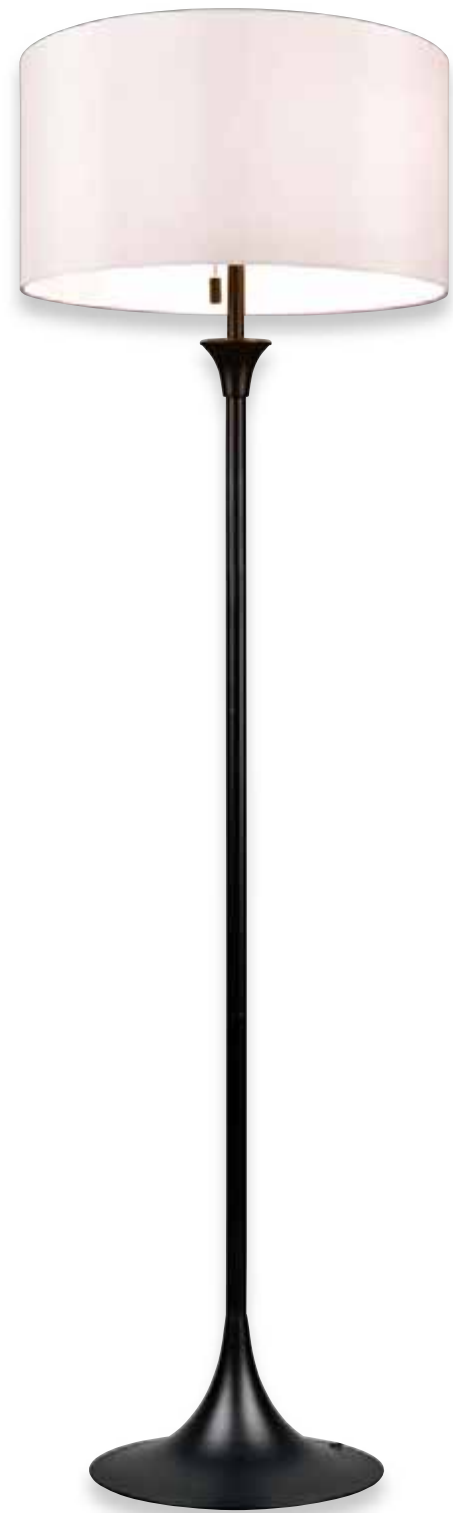

# SABIA

Nickel matt oder Schwarz matt, Stoff · nickel mat or black mat, fabric · nickel mat ou noir mat, tissu · nikkell mat of mat zwart, textiel · níquel mate o estera negra, tela · nichel opaco o nero opaco, tessuto · nichel mat sau negru mat, textil · harjattu teräs tai mattamusta, tekstiili · nikiel mat lub czarny mat, tkanina



Tischleuchte · Table lamp  
↑ 35 cm, Ø 20 cm  
excl. 1 x E27, max. 40 W



515790107  
515790132



Tischleuchte · Table lamp  
↑ 62,5 cm, Ø 40 cm  
excl. 1 x E27, max. 40 W



515700107  
515700132



Stehleuchte · Floor lamp  
↑ 155 cm, Ø 45,7 cm  
excl. 3 x E27, max. 40 W



415700307  
415700332







## CANNES II

Chrom / Aluminium gebürstet, Acryl, Stoffschirm · chrome / brushed aluminium, acryl, fabric shade · chrome / aluminium balayé, acryl, abat-jour tissu · chrom / geborsteld aluminium, acryl, Stoffen kap · cromo / aluminio pulido, acrílico, Pantalla de tela · cromo / alluminio spazzolato, acrilico, paralume in tessuto · crom / aluminiu lucios, acrilic, abajur textil · kromi / harjattu alumiini, akryyli, kangas varjostin · chrom / aluminium szczotkowane, akryl, Klosz z materiału

Stehleuchte · Floor lamp  
 † 165 cm, Ø 38 cm  
 incl. SMD-LED, 15,5 W  
 1.370 lm, 3.000 K  
 excl. 1 x E27, max. 60 W



422970206

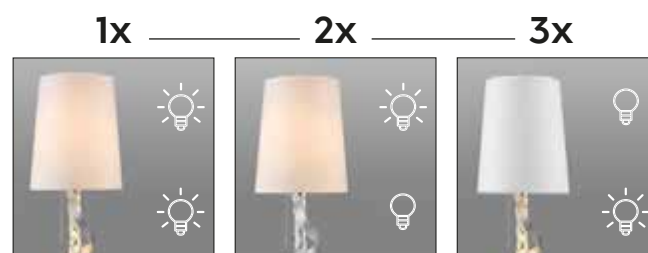

Getrennt schaltbar · Separately switchable · Interrupteurs séparés · Gescheiden schakelbaar · Interruptores separados · Interruttori separati · Intreruptoare separate · Erikseen kytkettävissä · Oddzileny przełącznik



## TANDORI

Nickel matt, Stoff · nickel mat, fabric · nickel mat, tissu · nikkel mat, tekstil · níquel mate, tela · nichel opaco, tessuto · nichel mat, textil · harjattu teräs, tekstiili · nikiel mat, tkanina



Getrennt schaltbar · Separately switchable  
 Interrupteurs séparés · Gescheiden schakelbaar · Interruptores separados · Interruttori separati · Intreruptoare separate · Erikseen kytkettävissä · Oddzileny przełącznik



Tischleuchte · Table lamp  
 † 53 cm, Ø 25 cm  
 incl. 3 x SMD-LED, 1,8 W  
 3 x 150 lm, 3.000 K  
 excl. 1 x E27, max. 40 W



575410207



Stehleuchte · Floor lamp  
 † 156 cm, Ø 40 cm  
 incl. 3 x SMD-LED, 5 W  
 3 x 470 lm, 3.000 K  
 excl. 1 x E27, max. 40 W



475410207



1x — 2x — 3x



Getrennt schaltbar · Separately switchable  
Interrupteurs séparés · Gescheiden schakelbaar ·  
Interruttori separati · Interrupatoare separate ·  
Erikseen kytkettävissä · Oddzileny przełącznik



## NANDOR

Metall, Stoff · metal, fabric ·  
metale, tissu · metaal, textiel · metal, tela ·  
metallo, tessuto · metal, textil · metalli, tekstiili · metal, tkanina



**Tischleuchte · Table lamp**  
↑ 62 cm, Ø 30 cm  
incl. 2 x SMD, 3 W  
2 x 300 lm, 3.000 K  
excl. 1 x E27, max. 40 W



575310307  
575310379



**Stehleuchte · Floor lamp**  
↑ 160,5 cm, Ø 40 cm  
incl. 2 x SMD, 7 W  
2 x 600 lm, 3.000 K  
excl. 1 x E27, max. 60 W



475310307  
475310379

07 | Nickel matt · nickel mat

79 | goldfarbig · gold





# CLAAS

Metall, Stoff · metal, fabric ·  
 metale, tissu · metaal, textiel · metal, tela ·  
 metallo, tessuto · metal, textil · metalli, tekstiili · metal, tkanina

USB Anschluss mit Ladefunktion ·  
 Recharging USB connection

**07** | Nickel matt · nickel mat

**32** | Schwarz matt · black mat



**Stehleuchte · Floor lamp**  
 ↑ 160 cm, ↔ 40 cm, ↗ 40 cm  
 excl. 1 x E27, max. 60 W



400400107  
 400400132



# PARIS II

Nickel matt oder Messing matt · nickel mat or brass mat ·  
 nickel mat ou laiton mat · nikkell mat of messing mat ·  
 níquel mate o bronze mate · nichel opaco o ottone satinato ·  
 nichel mat sau bronz mat · harjattu teräs tai mattamessinki ·  
 nikiel mat lub mosiądz mat

**07** | Nickel matt · nickel mat

**08** | Messing matt · brass mat



**Tischleuchte · Table lamp**  
 ↑ 58 cm, Ø 35 cm  
 excl. 1 x E27, max. 60 W



500200107  
 500200108



**Stehleuchte · Floor lamp**  
 ↑ 160 cm, Ø 50 cm  
 excl. 1 x E27, max. 60 W



400200107  
 400200108





# HOTEL

Metall, Stoffschirm · metal, fabric shade ·  
 metale, abat-jour tissu · metaal, Stoffen kap ·  
 metal, Pantalla de tela · metallo, paralume in tessuto ·  
 metal, abajur textil · metalli, kangas varjostin ·  
 metal, Klosz z materiału

Stehleuchte · Floor lamp  
 † 170 cm, Ø 40 cm, † 35 cm  
 excl. 1 x E27, max. 60 W  
 excl. 1 x E14, max. 18 W



403900201  
 403900208  
 403900211

**01** | Nickel matt, Schirm Weiß ·  
 nickel mat, shade white

**08** | Messing matt, Schirm Creme-Weiß ·  
 brass mat, shade cream white

**11** | Nickel matt, Schirm Grau ·  
 nickel mat, shade grey



# MOTEL

Metall, Stoffschirm · metal, fabric shade ·  
 metale, abat-jour tissu · metaal, Stoffen kap · metal, Pantalla de tela · metallo, paralume in tessuto ·  
 metal, abajur textil · metalli, kangas varjostin · metal, Klosz z materiału

**07** | Nickel matt, Schirm Schwarz/Weiß ·  
 nickel mat, shade black/white

**08** | Messing matt, Schirm Schwarz/goldfarbig ·  
 brass mat, shade black/gold



Stehleuchte · Floor lamp  
 † 164 cm, Ø 40 cm, † 54 cm  
 excl. 1 x E27, max. 60 W  
 excl. 1 x E14, max. 18 W



416900207  
 416900208







# CLARK

Metall, Schwarz matt, Stoffschirm mehrfarbig · metal, black mat, fabric shade multicolor ·  
 metale, noir mat, abat-jour tissu multicolore · metaal, mat zwart, Stoffen kap multicolor ·  
 metal, estera negra, Pantalla de tela multicolor · metallo, nero opaco, paralume in tessuto multicolore ·  
 metal, negru mat, abajur textil multicolor · metalli, mattamusta, kangas varjostin monivärinen ·  
 metal, czarny mat, Klosz z materiału multi-kolor



Stehleuchte · Floor lamp  
 † 198 cm, ↔ 35 cm, ↗ 170 cm  
 excl. 3 x E27, max. 60 W



401700317



# PONTE

Metall, Stoff · metal, fabric ·  
 metale, tissu · metaal, textiel · metal, tela ·  
 metallo, tessuto · metal, textil · metalli, tekstiili · metal, tkanina



31 | Weiß matt · white mat

32 | Schwarz matt · black mat



Stehleuchte · Floor lamp  
 † max. 168 cm, ↗ max. 125 cm, Ø 40 cm  
 excl. 1 x E27, max. 60 W



401600131  
 401600132





# PEREZ

Chrom, Marmor, Stoff · chrome, marble, fabric ·  
 chrome, marbre, tissu · chroom, marmer, textiel ·  
 cromo, mármol, tela · cromo, marmo, tessuto ·  
 crom, marmura, textil · kromi, marmori, tekstiili ·  
 chrom, marmur, tkanina

Stehleuchte · Floor lamp  
 † 170 - 200 cm, √ 170 cm, Ø 50 cm  
 excl. 3 x E27, max. 60 W



421100301  
 421100302



01 | Weiß · white

02 | Schwarz · black



# TRACY

Metall, Schwarz matt, Stoffschirm · metal, black mat, fabric shade ·  
 metale, noir mat, abat-jour tissu · metaal, mat zwart, Stoffen kap · metal, estera negra, Pantalla de tela ·  
 metallo, nero opaco, paralume in tessuto · metal, negru mat, abajur textil · metalli, mattamusta, kangas varjostin ·  
 metal, czarny mat, Klosz z materiału

Stehleuchte · Floor lamp  
 † 175 cm, Ø 40 cm, √ max. 105 cm  
 excl. 1 x E27, max. 60 W



462100132





# SOLA

Chrom, Marmor, Acryl · chrome, marble, acryl ·  
 chrome, marbre, acryl · chroom, marmer, acryl ·  
 cromo, márml, acrílico · cromo, marmo, acrílico ·  
 crom, marmura, acrilic · kromi, marmori, akryyli ·  
 chrom, marmur, akryl

Stehleuchte · Floor lamp  
 † 176 - 200 cm, √ 180 cm, Ø 40 cm  
 excl. 1 x E27, max. 75 W



4200011-06



# ARGENTINA

Messing matt, Marmor · brass mat, marble ·  
 laiton mat, marbre · messing mat, marmer · bronze mate, márml ·  
 ottone satinato, marmo · bronz mat, marmura · mattamessinki, marmori ·  
 mosiądz mat, marmur

Stehleuchte · Floor lamp  
 † 200 cm, Ø 38 cm, √ 172,5 cm  
 excl. 1 x E27, max. 75 W



411700108







# BANGKOK

Metall, Schwarz matt, Marmor · metal, black mat, marble ·  
 métal, noir mat, marbre · metaal, mat zwart, marmer · metal, estera negra, mármol ·  
 metallo, nero opaco, marmo · metal, negru mat, marmura · metalli, mattamusta, marmori ·  
 metal, czarny mat, marmur

 Integrierter Dimmer ·  
 Integrated dimmer

**Stehleuchte · Floor lamp**  
 † 180 cm, ↔ 22 x 23 cm, ∇ 127,5 cm  
 incl. SMD-LED, 18 W  
 2.200 lm, 3.000 K





426511832



# SHANGHAI

Metall · metal ·  
 metale · metaal · metallo ·  
 metal · metalli · metal

 Integrierter Dimmer ·  
 Integrated dimmer

-  **01** | Weiß · white
-  **02** | Schwarz · black
-  **87** | titanfarbig · titanium-coloured



**Stehleuchte · Floor lamp**  
 † 210 cm, ↔ 65 cm, ∇ 200 cm  
 incl. SMD-LED, 18 W  
 1.800 lm, 3.000 K



427511801  
 427511802  
 427511887





3.000 K

4.500 K

6.500 K

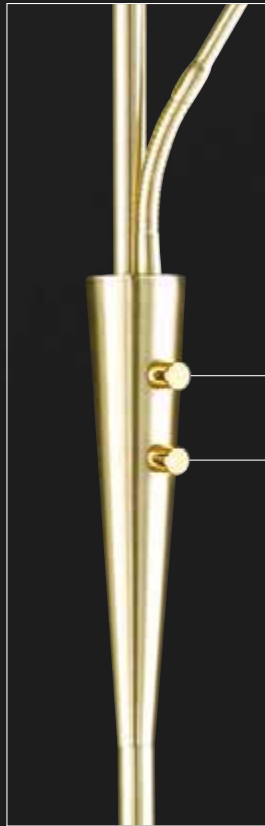



Dimmen und Lichtfarbe einstellen ·  
 Dimming and adjusting light color ·  
 Varier et choisir la couleur de la lumière ·  
 Dimmen en lichtkleur instellen ·  
 Atenuación y ajuste del color de la luz ·  
 Variare e scegliere il colore della luce ·  
 Variati lumina si ajustati culoarea luminii ·  
 Himmennys ja värilämpötilan säätö vakiokytkimellä ·  
 ściemniać i jasność ustawić



## QUEBEC

Nickel matt oder Messing matt · nickel mat or brass mat ·  
 nickel mat ou laiton mat · nikkell mat of messing mat ·  
 níquel mate o bronce mate · nichel opaco o ottone satinato ·  
 nichel mat sau bronz mat · harjattu teräs tai mattamessinki ·  
 nikiel mat lub mosiądz mat

-  Lichtfarbe einstellbar ·  
Adjustable light color
-  Integrierter Dimmer ·  
Integrated dimmer
-  Memory Funktion ·  
Memory function



07 | Nickel matt · nickel mat

08 | Messing matt · brass mat

Stehleuchte · Floor lamp  
 † 180 cm, ∅ 50 cm  
 incl. SMD-LED, 35 W  
 4.200 lm, 3.000 + 4.500 + 6.500 K  
 incl. SMD-LED, 5,5 W  
 600 lm, 3.000 + 4.500 + 6.500 K



422710307  
 422710308





# GRANBY

Metall · metal ·  
metale · metaal · metal · metallo · metal · metalli · metal

 Lichtfarbe einstellbar ·  
Adjustable light color

 Sensordimmer ·  
Sensor dimmer

 Memory Funktion ·  
Memory function

-  **04** | Altmessing · old brass
-  **07** | Nickel matt · nickel mat
-  **08** | Messing matt · brass mat
-  **32** | Schwarz matt · black mat

**Stehleuchte · Floor lamp**  
180 cm, ↔ 29,5 cm, 46 cm  
incl. SMD-LED, 29 W  
3.400 lm, 2.700 + 3.200 + 4.000 K  
incl. SMD-LED, 6,5 W  
650 lm, 2.700 + 3.200 + 4.000 K



424310204  
424310207  
424310208  
424310232









# BRANTFORD





Metall · metal ·  
metale · metaal · metal · metallo · metal · metalli · metal

 Lichtfarbe einstellbar ·  
Adjustable light color

 Sensordimmer ·  
Sensor dimmer

 Memory Funktion ·  
Memory function



-  **04** | Altmessing · old brass
-  **07** | Nickel matt · nickel mat
-  **08** | Messing matt · brass mat
-  **32** | Schwarz matt · black mat

**Stehleuchte · Floor lamp**  
 † 180 cm, ↔ 30 cm, ∠ 41,6 cm  
 incl. SMD-LED, 30 W  
 3.500 lm, 2.700 + 3.200 + 4.000 K  
 incl. SMD-LED, 6,5 W  
 650 lm, 2.700 + 3.200 + 4.000 K



425610204  
 425610207  
 425610208  
 425610232



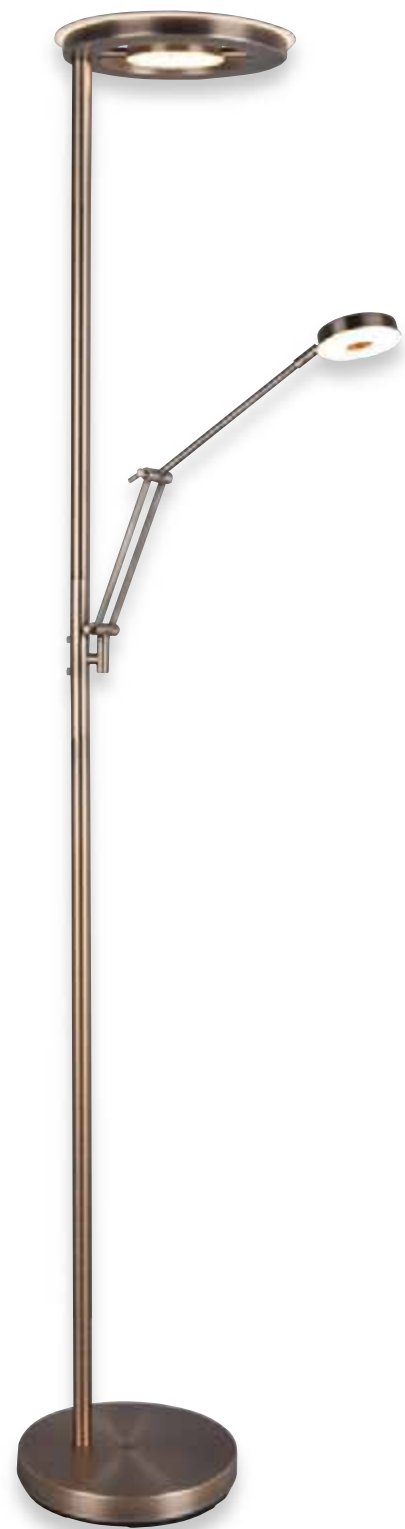

# BARRIE

Metall · metal ·  
metale · metaal · metal · metallo ·  
metal · metalli · metal

Lichtfarbe einstellbar ·  
Adjustable light color

Sensordimmer ·  
Sensor dimmer

Memory Funktion ·  
Memory function

04 | Altmessing · old brass

07 | Nickel matt · nickel mat

32 | Schwarz matt · black mat



**Stehleuchte · Floor lamp**  
‡ 181 cm, Ø 30 cm, † 70 cm  
incl. SMD-LED, 32 W, 3.700 lm  
incl. SMD-LED, 6 W, 700 lm  
2.700 + 4.000 K



424210304  
424210307  
424210332







# ARANGO

Nickel matt oder Altmessing · nickel mat or old brass · nickel mat ou laiton fumé · nikkell mat of oud brons · níquel mate o bronze viejo · nichel opaco o ottone invecchiato · nichel mat sau bronz antic · harjattu teräs tai antiikkimessinki · nikiel mat lub patyna

 Integrierter Dimmer · Integrated dimmer

**Stehleuchte · Floor lamp**  
↑ 180 cm, Ø 31 cm  
incl. 1 x SMD-LED, 18 W  
2.000 lm, 3.000 K



429110104 | Altmessing · old brass  
429110107 | Nickel matt · nickel mat



# ARIZONA

Nickel matt oder Messing matt · nickel mat or brass mat · nickel mat ou laiton mat · nikkell mat of messing mat · níquel mate o bronze mate · nichel opaco o ottone satinato · nichel mat sau bronz mat · harjattu teräs tai mattamessinki · nikiel mat lub mosiądz mat

 Sensordimmer · Sensor dimmer

**Stehleuchte · Floor lamp**  
↑ 180 cm, Ø 25,5 cm, √ 40 cm  
incl. SMD-LED, 20 W, 2.000 lm, 3.000 K  
incl. 1 x SMD-LED, 5 W, 500 lm, 3.000 K



426410207 | Nickel matt · nickel mat  
426410208 | Messing matt · brass mat



# SANTO II

Metall, Glas alabasterfarbig · metal, alabaster-coloured glass · metale, verre couleur albâtre · metaal, albastkleurig glas · metal, vidrio de color alabastro · metallo, vetro colore alabastro · metal, sticla culoare alabastru · metalli, lasi alabasteri väri · metal, szkło alabaster kolor

 Integrierter Dimmer · Integrated dimmer



07 | Nickel matt · nickel mat

28 | rostfarbig antik · antique rust



**Stehleuchte · Floor lamp**  
↑ 180 cm, Ø 25,5 cm, √ 40 cm  
incl. 4 x SMD-LED, 4,8 W, 4 x 450 lm, 3.000 K  
incl. 1 x SMD-LED, 4,8 W, 450 lm, 3.000 K



421910207  
421910228





# CHRIS

Chrom, Acryl mit Kristalleffekt · chrome, broken glass optic · chrome, optique verre pilé · chroom, gebroken glas optiek · cromo, efecto cristal roto · cromo, effetto ottico vetro rotto · crom, aspect de sticla sparta · kromi, lasi efekti optiikka · chrom, optyczne rozbite szkło

 Integrierter Dimmer · Integrated dimmer



Deckenleuchte · Ceiling lamp  
↓ 180 cm, ↗ 52 cm  
incl. 1 x SMD-LED, 18 W, 2.000 lm, 3.000 K  
incl. 1 x SMD-LED, 3,8 W, 350 lm, 3.000 K

    
478310206





 Stufenlos dimmbar, Lichtfarbe stufenlos einstellbar · infinitely dimmable, light color infinitely variable · infiniment dimmable, couleur de lumière infiniment variable · traploos dimbaar, lichtkleur traploos instelbaar · sin etapas regulable, color de luz infinitamente variable · infinitamente dimmerabile, colore della luce infinitamente variabile · variator de lumina fara trepte, cu intrerupator standard de lumina · portaaton himmennys, valon väri portaattomasti · bezstopniowe ściemnianie, jasny kolor bezstopniowo

# SPLIT



Nickel matt · nickel mat · nickel mat · nikkell mat · níquel mate · nichel opaco · nichel mat · harjattu teräs · nikiel mat

 Lichtfarbe stufenlos einstellbar · Light color infinitely variable

 Integrierter Dimmer · Integrated dimmer

 Memory Funktion · Memory function

Stehleuchte · Floor lamp  
↓ 181 cm, ↔ 33 cm, ↗ 43 cm  
incl. SMD-LED, 20 W  
2.000 lm, 3.000 - 6.500 K  
incl. 1 x SMD-LED, 3,5 W  
400 lm, 3.000 - 6.500 K

    
424910207





## PAVIA

Metall, Altmessing, Schwarz matt oder Weiß matt · metal, old brass, black mat or white mat ·  
 métal, laiton fumé, noir mat ou blanc mat · metaal, oud brons, mat zwart of wit mat ·  
 metal, bronce viejo, estera negra o estera blanca · metallo, ottone invecchiato, nero opaco  
 o bianco opaco · metal, bronz antic, negru mat sau alb mat · metalli, antiikkimessinki,  
 mattamusta tai mattavalkoinen · metal, patyna, czarny mat lub biały mat



Lichtfarbe einstellbar ·  
 Adjustable light color



**04** | Altmessing · old brass



**31** | Weiß matt · white mat



**32** | Schwarz matt · black mat



Sensordimmer ·  
 Sensor dimmer



Integrierter Dimmer ·  
 Integrated dimmer



Tischleuchte · Table lamp  
 ↑ 38,5 cm, ↔ 14 cm, ↗ 43 cm  
 incl. SMD-LED, 12 W  
 1.400 lm, 2.300 + 3.000 + 4.000 K



570310104  
 570310131  
 570310132



Stehleuchte · Floor lamp  
 ↑ 130,5 cm, ↔ 16 cm, ↗ 48 cm  
 incl. SMD-LED, 12 W  
 1.400 lm, 2.300 + 3.000 + 4.000 K



470310104  
 470310131  
 470310132







Tischleuchte · Table lamp  
↑ 57 cm, ↔ 19 cm, ↗ 46 cm  
incl. SMD-LED, 12 W  
1.400 lm, 2.300 + 3.000 + 4.000 K



523310107  
523310108  
523310132



Stehleuchte · Floor lamp  
↑ 145 cm, ↔ 25 cm, ↗ 50 cm  
incl. SMD-LED, 12 W  
1.400 lm, 2.300 + 3.000 + 4.000 K



423310107  
423310108  
423310132

# MONZA

Metall · metal ·  
metale · metaal · metal ·  
metallo · metal · metalli · metal

Lichtfarbe einstellbar ·  
Adjustable light color

Sensordimmer ·  
Sensor dimmer

Memory Funktion ·  
Memory function

07 | Nickel matt · nickel mat

08 | Messing matt · brass mat

32 | Schwarz matt · black mat







# BERGAMO



Nickel matt oder Messing matt · nickel mat or brass mat · nickel mat ou laiton mat · nikkell mat of messing mat · níquel mate o bronze mate · nichel opaco o ottone satinato · nichel mat sau bronz mat · harjattu teräs tai mattamessinki · nikiel mat lub mosiądz mat

 Sensordimmer · Sensor dimmer

-  **07** | Nickel matt · nickel mat
-  **08** | Messing matt · brass mat





**Tischleuchte · Table lamp**  
 † 50 cm, † 40 cm  
 incl. 1 x SMD-LED, 12 W  
 1.100 lm, 3.000 K

   
**520910107**  
**520910108**



**Stehleuchte · Floor lamp**  
 † 135 cm, † 50 cm  
 incl. 1 x SMD-LED, 12 W  
 1.100 lm, 3.000 K

   
**420910107**  
**420910108**



# VERONA

Nickel matt · nickel mat · nickel mat · nikkell mat · níquel mate · nichel opaco · nichel mat · harjattu teräs · nikiel mat



 Sensordimmer · Sensor dimmer · Variateur tactile · Touchdimmer · Regulador con sensor · Touchdimmer · Variator cu senzor · Kosketushimmennin · Czujnik ściemniania ·



**Stehleuchte · Floor lamp**  
 † 126 cm, † 60 cm  
 incl. 1 x SMD-LED, 12 W  
 1.100 lm, 3.000 K

  
**420810107**



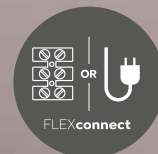

Seite/page 632

## KAZAN

Nickel matt oder Schwarz matt · nickel mat or black mat ·  
 nickel mat ou noir mat · nikkell mat of mat zwart ·  
 níquel mate o estera negra · nichel opaco o nero opaco ·  
 nichel mat sau negru mat · harjattu teräs tai musta matto ·  
 nikiel mat lub czarny mat



07 | Nickel matt · nickel mat

32 | Schwarz matt · black mat



**Wandleuchte · Wall lamp**  
 Ø 14 cm, √ max. 55 cm  
 incl. 1 x SMD, 8 W  
 800 lm, 3.000 K



274770107  
 274770132



**Stehleuchte · Floor lamp**  
 † 121,5 cm, ↔ 24 cm, √ max. 61,5 cm  
 incl. 1 x SMD, 8 W  
 800 lm, 3.000 K



474790107  
 474790132





## CALCIO

Nickel matt oder Messing matt · nickel mat or brass mat ·  
nickel mat ou laiton mat · nikkell mat of messing mat · níquel mate o bronze mate ·  
nichel opaco o ottone satinato · nichel mat sau bronz mat · harjattu teräs tai mattamessinki ·  
nikiel mat lub mosiądz mat



Integrierter Dimmer ·  
Integrated dimmer



07 | Nickel matt · nickel mat

08 | Messing matt · brass mat



Tischleuchte · Table lamp  
↓ 43 cm, ↗ 50 cm  
incl. 1 x SMD-LED, 6 W  
560 lm, 3.000 K



572410107  
572410108



Stehleuchte · Floor lamp  
↓ 120 - 140 cm, ↗ max. 71 cm  
incl. 1 x SMD-LED, 10 W  
1.050 lm, 3.000 K



422410107  
422410108







Tischleuchte · Table lamp  
 ↑ 45 cm, ↔ 12 cm, ↗ 25 cm  
 excl. 1 x GU10, max. 5 W



- 512400107
- 512400108
- 512400131
- 512400132



Stehleuchte · Floor lamp  
 ↑ 151 cm, ↔ 23 cm, ↗ 39 cm  
 excl. 1 x GU10, max. 5 W



- 412400107
- 412400108
- 412400131
- 412400132

## MARLEY

Metall · metal ·  
 metale · metaal · metal · metallo · metal · metalli · metal

Empfohlen:  
 recommended: LED GU10, 4,5 W  
 345 lm, 3.000 K



956-55



07 | Nickel matt · nickel mat



08 | Messing matt / Schwarz matt  
 brass matt / black mat



31 | Weiß matt · white mat



32 | Schwarz matt · black mat





# NARCOS

Nickel matt, Weiß matt oder Schwarz matt · nickel mat, white mat or black mat ·  
nickel mat, blanc mat ou noir mat · nikkell mat, wit mat of mat zwart · níquel mate, estera blanca o estera negra ·  
nichel opaco, bianco opaco o nero opaco · nichel mat, alb mat sau negru mat · harjattu teräs, valkoinen matto tai musta matto ·  
nikiel mat, biały mat lub czarny mat

4 fach TOUCH ·  
4 level Touch function

Stehleuchte · Floor lamp  
↑ 154 cm, ↔ 28 cm  
incl. 3 x SMD-LED, 4,7 W  
3 x 470 lm, 3.000 K



473190307  
473190331  
473190332

- 07 | Nickel matt · nickel mat
- 31 | Weiß matt · white mat
- 32 | Schwarz matt · black mat



# FILIGRAN

Nickel matt oder Schwarz matt · nickel mat or black mat ·  
nickel mat ou noir mat · nikkell mat of mat zwart · níquel mate o estera negra ·  
nichel opaco o nero opaco · nichel mat sau negru mat · harjattu teräs tai mattamusta · nikiel mat lub czarny mat

Sensordimmer ·  
Sensor dimmer

Stehleuchte · Floor lamp  
↑ 162 cm, ↗ 52 cm  
incl. 1 x SMD-LED, 6 W  
560 lm, 3.000 K



420490107  
420490132

- 07 | Nickel matt · nickel mat
- 32 | Schwarz matt · black mat

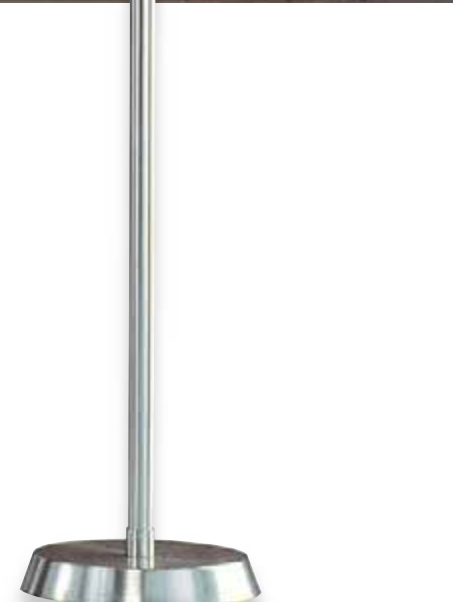





## DAKOTA

Metall, schwarz matt · metal, black mat ·  
metale, noir mat · metaal, mat zwart · metal, estera negra ·  
metallo, nero opaco · metal, negru mat · metalli, mattamusta · metal, czarny mat

Empfohlen:  
recommended: LED G9, 3 W  
300 lm, 3.000 K



929-230

Stehleuchte · Floor lamp  
↓ 155 cm, ↔ 23 cm  
excl. 3 x G9, max. 28 W



404600332



## EDWARD

Metall, Schwarz matt · metal, black mat ·  
metale, noir mat · metaal, mat zwart ·  
metal, estera negra · metallo, nero opaco ·  
metal, negru mat · metalli, mattamusta ·  
metal, czarny mat

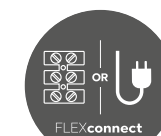

Seite/page 632



Wandleuchte · Wall lamp  
↓ 25 cm, ↔ 12 cm, ↗ 50 cm  
excl. 1 x E14, max. 40 W



208870132



Stehleuchte · Floor lamp  
↓ 160 cm, ↔ 38 cm  
excl. 3 x E14, max. 40 W



408800332





# FREDDY

Nickel matt, Glas matt · nickel mat, mat glass · nickel mat, verre mat · nikkel mat, mat glas · níquel mate, vidrio mate · nichel opaco, vetro sabbiato · nichel mat, sticla mata · harjattu teräs, mattalasi · nikiel mat, szkło matowane



incl.  
LED E14, 3,5 W  
320 lm, 3.000 K

983-40



**Stehleuchte · Floor lamp**  
‡ 125 cm, † 55 cm  
incl. 2 x LED E14, 4 W  
2 x 320 lm, 3.000 K



424810207



**Stehleuchte · Floor lamp**  
‡ 150 cm, † 55 cm  
incl. 1 x LED E14, 4 W  
320 lm, 3.000 K



424810107



# ICARO

Metall, Glas matt · metal, mat glass · metale, verre mat · metaal, mat glas · metal, vidrio mate · metallo, vetro sabbiato · metal, sticla mata · metalli, mattalasi · metal, szkło matowane

**Stehleuchte · Floor lamp**  
‡ 165 cm, † 54 cm  
excl. 1 x E27, max. 60 W



4035011-04  
4035011-07  
4035011-08



04 | Altmessing · old brass



07 | Nickel matt · nickel mat



08 | Messing matt · brass mat





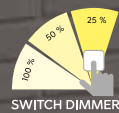

# TEXEL

Metall Schwarz matt/goldfarbig · metal black mat/gold ·  
 metale noir mat/or · metaal mat zwart/goud · metal estera negra/oro ·  
 metallo nero opaco/oro · metal negru mat/aur · metalli musta matto/kultaa ·  
 metal czarny mat/zlota



**Tischleuchte · Table lamp**  
 ↓ 47,5 cm, Ø 16 cm  
 incl. 1 x SMD-LED, 6,8 W  
 650 lm, 3.000 K



574410179



**Stehleuchte · Floor lamp**  
 ↓ 142,5 cm, Ø 25 cm  
 incl. 1 x SMD-LED, 15 W  
 1.450 lm, 3.000 K



474410179



# LIÈGE

Holz, Metall, Schwarz matt/goldfarbig · wood, metal, black mat/gold ·  
 bois, metale, noir mat/or · hout, metaal, mat zwart/goud ·  
 madera, metal, estera negra/oro · di legno, metallo, nero opaco/oro ·  
 lemn, metal, negru mat/aur · puu, metalli, mattamusta/kultaa ·  
 drewno, metal, czarny mat/zlota

Empfohlen:  
 recommended: Filament LED E27, 7 W  
 806 lm, 2.700 K



987-6810



**Stehleuchte · Floor lamp**  
 ↓ 120 - 160 cm, ↔ 80 cm  
 excl. 1 x E27, max. 60 W



407800132





# LANCE

Metall, Chrom oder Schwarz, Glas rauchfarbig oder mehrfarbig ·  
 metal, chrome or black, glass smoke or multicolor ·  
 metale, chrome ou noir, verre fumé ou multicolore ·  
 metaal, chrom of zwart, glas rookkleur of multicolor ·  
 metal, cromo o negro, vidrio humo o multicolor ·  
 metallo, cromo o nero, vetro fume' o multicolore ·  
 metal, crom sau negru, sticla fumuriu sau multicolor ·  
 metalli, kromi tai musta, lasi savu tai monivärinen ·  
 metal, chrom lub czarny, szkło przydymiony lub multi-kolor

Stehleuchte · Floor lamp  
 † 156 cm, Ø 60 cm  
 excl. 3 x E14, max. 28 W



403400317 | mehrfarbig · multicolor  
 403400354 | rauchfarbig · smoke



Chrom, Glas rauchfarbig ·  
 chrome, glass smoke



Schwarz matt, Glas multicolor ·  
 black mat, glass multicolor





# JOOST II

Nickel matt, Glas matt · nickel mat, mat glass ·  
nickel mat, verre mat · nikkel mat, mat glas ·  
níquel mate, vidrio mate · nichel opaco, vetro sabbaiato ·  
nichel mat, sticla mata · harjattu teräs, mattalasi ·  
nikiel mat, szkło matowane



On/Off Touch Funktion ·  
On/Off Touch function

Empfohlen:  
recommended: LED E27, 4,9 W  
470 lm, 3.000 K



987-60



Tischleuchte · Table lamp  
↑ 39 cm, Ø 19 cm  
excl. 1 x E27, max. 60 W



592300107

# HENK II

Metall, Glas alabasterfarbig · metal, alabaster-coloured glass ·  
metale, verre couleur albâtre · metaal, albastkleurig glas ·  
metal, vidrio de color alabastro · metallo, vetro colore alabastro ·  
metal, sticla culoare alabastru · metalli, lasi alabasteri väri ·  
metal, szkło alabaster kolor

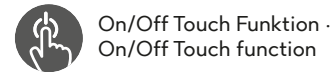

On/Off Touch Funktion ·  
On/Off Touch function



07 | Nickel matt · nickel mat



08 | Messing matt · brass mat

Tischleuchte · Table lamp  
↑ 37 cm, Ø 26 cm  
excl. 1 x E14, max. 40 W



592600107  
592600108



Empfohlen:  
recommended: LED E14, 3,5 W  
320 lm, 3.000 K



983-43



# BERLIN

Metall, Glas matt · metal, mat glass ·  
metale, verre mat · metaal, mat glas ·  
metal, vidrio mate · metallo, vetro sabbaiato ·  
metal, sticla mata · metalli, mattalasi ·  
metal, szkło matowane · metal, mat cam



4 fach TOUCH ·  
4 level Touch function



Tischleuchte · Table lamp  
↑ 39 cm, Ø 19,5 cm  
incl. 1 x SMD-LED, 4 W  
350 lm, 3.000 K



527590107 | Nickel matt · nickel mat  
527590132 | Schwarz matt · black mat  
527590179 | goldfarbig · gold



# CRISTO

Chrom oder Nickel matt, Glas · chrome or nickel mat, glass · chrome ou nickel mat, verre · chrom of nikkel mat, glas · cromo o níquel mate, vidrio · cromo o nichel opaco, vetro · crom sau nichel mat, sticla · kromi tai harjattu teräs, lasi · chrom lub nikiel mat, szkło

 4 fach TOUCH · 4 level Touch function

 **00** | Chrome, Transparent · chrome, transparent

 **07** | Nickel matt, Glas weiß · nickel mat, glass white



478 Tischleuchte · Table lamp

↑ 14,5 cm, Ø 11 cm  
incl. 1 x SMD-LED, 4,3 W  
430 lm, 3.000 K



529690100  
529690107



# DONNA

Metall, Glas alabasterfarbig · metal, alabaster-coloured glass · metale, verre couleur albâtre · metaal, albastkleurig glas · metal, vidrio de color alabastro · metallo, vetro colore alabastro · metal, sticla culoare alabastru · metalli, lasi alabasteri väri · metal, szkło alabaster kolor

 4 fach TOUCH · 4 level Touch function

 **07** | Nickel matt · nickel mat

 **08** | Messing matt · brass mat

Tischleuchte · Table lamp

↑ 30 cm, Ø 22,5 cm  
incl. 1 x SMD-LED, 4,5 W  
450 lm, 3.000 K



525790107  
525790108



# VENTURA

Metall, Glas matt · metal, mat glass · metale, verre mat · metaal, mat glas · metal, vidrio mate · metallo, vetro sabbato · metal, sticla mata · metalli, mattalasi · metal, szkło matowane

 4 fach TOUCH · 4 level Touch function

 **03** | Messing poliert · polished brass

 **07** | Nickel matt · nickel mat



Tischleuchte · Table lamp

↑ 29 cm, Ø 15,5 cm  
incl. 1 x SMD-LED, 4 W  
350 lm, 3.000 K



529990103  
529990107





# LUIS II

Metall, Glas alabasterfarbig · metal, alabaster-coloured glass ·  
metale, verre couleur albâtre · metaal, albastkleurig glas ·  
metal, vidrio de color alabastro · metallo, vetro colore alabastro ·  
metal, sticla culoare alabastru · metalli, lasi alabasteri väri ·  
metal, szkło alabaster kolor



On/Off Touch Funktion ·  
On/Off Touch function



06 | Chrom · chrome



07 | Nickel matt · nickel mat



08 | Messing matt · brass mat

Tischleuchte · Table lamp  
↓ 32 cm, Ø 12  
excl. 1 x E14, max. 40 W



Empfohlen:  
recommended: LED E14, 3,5 W  
320 lm, 3.000 K



983-40

595700106  
595700107  
595700108



# EMERALD

Metall, Glas matt · metal, mat glass ·  
metale, verre mat · metaal, mat glas · metal, vidrio mate ·  
metallo, vetro sabbaiato · metal, sticla mata · metalli, mattalasi ·  
metal, szkło matowane



4 fach TOUCH ·  
4 level Touch function



06 | Chrom · chrome



07 | Nickel matt · nickel mat

Tischleuchte · Table lamp  
↓ 29 cm, Ø 15 cm  
incl. 1 x SMD-LED, 4,5 W  
450 lm, 3.000 K



525490106  
525490107



# FYNN II

Metall, Glas alabasterfarbig · metal, alabaster-coloured glass ·  
metale, verre couleur albâtre · metaal, albastkleurig glas · metal, vidrio de color alabastro ·  
metallo, vetro colore alabastro · metal, sticla culoare alabastru · metalli, lasi alabasteri väri ·  
metal, szkło alabaster kolor



On/Off Touch Funktion ·  
On/Off Touch function

Empfohlen:  
recommended: LED E14, 3,5 W  
320 lm, 3.000 K



983-40



Tischleuchte · Table lamp  
↓ 21 cm, Ø 15 cm  
excl. 1 x E14, max. 40 W



599100106 | Chrom · chrome  
599100107 | Nickel matt · nickel mat  
599100108 | Messing matt · brass mat  
599100118 | Orange · orange  
599100124 | rostfarbig · rusty



# ARY II

Metall, Glas matt · metal, mat glass ·  
metale, verre mat · metaal, mat glas · metal, vidrio mate ·  
metallo, vetro sabbaiato · metal, sticla mata · metalli, matalasi ·  
metal, szklo matowane

 On/Off Touch Funktion ·  
On/Off Touch function

 **07** | Nickel matt · nickel mat

 **32** | Schwarz matt · black mat

482

Tischleuchte · Table lamp

↑ 15 cm, Ø 9 cm  
excl. 1 x E14, max. 40 W



591000107  
591000132



Empfohlen:  
recommended: LED E14, 3,5 W  
320 lm, 3.000 K



983-40

483



# TILL II

Metall, Glas matt · metal, mat glass ·  
metale, verre mat · metaal, mat glas · metal, vidrio mate ·  
metallo, vetro sabbaiato · metal, sticla mata · metalli, matalasi ·  
metal, szklo matowane

 On/Off Touch Funktion ·  
On/Off Touch function

 **07** | Nickel matt · nickel mat

 **32** | Schwarz matt · black mat

Tischleuchte · Table lamp

↑ 14,5 cm, ↔ 10 x 15 cm  
excl. 1 x E14, max. 40 W



590200107  
590200132



Empfohlen:  
recommended: LED E14, 3,5 W  
320 lm, 3.000 K



983-40

# DAVI II

Metall, Glas matt · metal, mat glass ·  
metale, verre mat · metaal, mat glas · metal, vidrio mate ·  
metallo, vetro sabbaiato · metal, sticla mata · metalli, matalasi ·  
metal, szklo matowane

 On/Off Touch Funktion ·  
On/Off Touch function

Empfohlen:  
recommended: LED E14, 3,5 W  
320 lm, 3.000 K



983-40

 **07** | Nickel matt ·  
nickel mat

 **32** | Schwarz matt ·  
black mat



Tischleuchte · Table lamp  
↑ 15 cm, ↔ 10 x 15 cm  
excl. 1 x E14, max. 40 W



590100107  
590100132







# MATS II

Nickel matt, Stoff · nickel mat, fabric ·  
 nickel mat, tissu · nikkel mat, textiel · níquel mate, tela ·  
 nichel opaco, tessuto · nichel mat, textil · harjattu teräs, tekstiili · nikiel mat, tkanina

 On/Off Touch Funktion ·  
 On/Off Touch function

 **01** | Weiß · white

 **42** | Anthrazit · anthracite

 **15** | Grün · green

 **19** | Türkis · turquoise

Tischleuchte · Table lamp  
 ↓ 24 cm, Ø 14 cm  
 excl. 1 x E14, max. 40 W



599700101  
 599700115  
 599700119  
 599700142

Empfohlen:  
 recommended: LED E14, 3,5 W  
 320 lm, 3.000 K



983-40

# PIET II

Nickel matt, Stoff · nickel mat, fabric ·  
 nickel mat, tissu · nikkel mat, textiel · níquel mate, tela ·  
 nichel opaco, tessuto · nichel mat, textil · harjattu teräs, tekstiili · nikiel mat, tkanina

 On/Off Touch Funktion ·  
 On/Off Touch function

 **01** | Weiß · white

 **02** | Schwarz · black

 **42** | Anthrazit · anthracite

Empfohlen:  
 recommended: LED E14, 3,5 W  
 320 lm, 3.000 K



983-40

Tischleuchte · Table lamp  
 ↓ 35 cm, ↔ 12 x 12 cm  
 excl. 1 x E14, max. 40 W



591600101  
 591600102  
 591600142





# AMSTERDAM

Metall, Weiß oder Schwarz · metal, white or black ·  
metale, blanc ou noir · metaal, wit of zwart · metal, blanco o negro ·  
metallo, bianco o nero · metal, alb sau negru · metalli, valkoinen tai musta ·  
metal, biały lub czarny



Tischleuchte · Table lamp  
↑ max. 90 cm, ↗ max. 90 cm, Ø 18 cm  
incl. 1 x COB-LED, 5 W  
500 lm, 3.000 K



527920101 | Weiß · white  
527920102 | Schwarz · black



# AVA

Kunststoff · plastic ·  
plastique · kunststof · plástico ·  
plastica · plastic · muovi · plastik

-  Lichtfarbe einstellbar ·  
Adjustable light color
-  Sensordimmer ·  
Sensor dimmer
-  USB Anschluss mit Ladefunktion ·  
Recharging USB connection
-  Memory Funktion ·  
Memory function



Tischleuchte · Table lamp  
↑ 40,4 cm, ↔ 17,1 cm, ↗ 30,5 cm  
incl. SMD-LED, 5,2 W  
600 lm, 3.000 + 4.000 + 6.300 K



523090131 | Weiß matt · white mat  
523090132 | Schwarz matt · black mat



# RODERIC

Metall, Anthrazit, Kunststoff · metal, anthracite, plastic ·  
 métal, anthracite, plastique · metaal, antraciet, kunststof ·  
 metal, antracita, plástico · metallo, antracite, plastica ·  
 metal, antracit, plastic · metalli, antrasiitti, muovi ·  
 metal, antracyt, plastik



Tischleuchte · Table lamp  
 ↓ 50 cm, ↔ 19 cm, ↗ 55 cm  
 incl. 1 x SMD-LED, 6 W  
 800 lm, 3.000 K



527410142



# VARIO

Metall, Kunststoff · metal, plastic ·  
 metale, plastique · metaal, kunststof · metal, plástico ·  
 metallo, plastica · metal, plastic · metalli, muovi · metal, plastik



02 | Schwarz · black

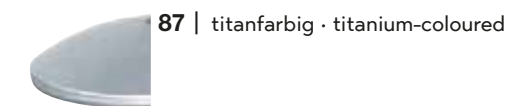

87 | titanfarbig · titanium-coloured



Tischleuchte · Table lamp  
 ↓ max. 64,5 cm, ↗ max. 50 cm  
 incl. SMD-LED, 3,6 W  
 200 lm, 3.000 K



522520102  
 522520187



# RADO

Metall, Kunststoff · metal, plastic ·  
 metale, plastique · metaal, kunststof · metal, plástico ·  
 metallo, plastica · metal, plastic · metalli, muovi · metal, plastik



Lichtfarbe einstellbar ·  
 Adjustable light color



4 fach TOUCH ·  
 4 level Touch function

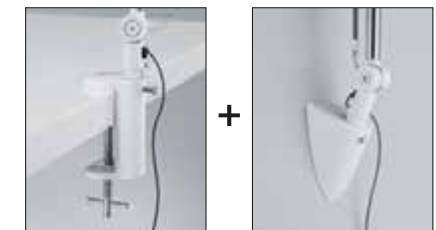

31 | Weiß matt · white mat

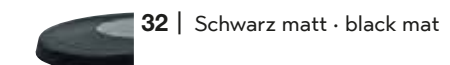

32 | Schwarz matt · black mat

Tischleuchte · Table lamp  
 ↓ 70 cm, ↗ 38 cm  
 incl. 1 x SMD-LED, 5 W  
 700 lm, 3.000 + 4.000 + 5.000 K



527690131  
 527690132





4 fach TOUCH ·  
4 level Touch function

## CURTIS

Altmessing, Nickel matt oder Messing matt · old brass, nickel mat or brass mat ·  
laiton fumé, nickel mat ou laiton mat · oud brons, nikkell mat of messing mat · bronce viejo,  
níquel mate o bronce mate · ottone invecchiato, nichel opaco o ottone satinato ·  
bronz antic, nichel mat sau bronz mat · antiikkimessinki, harjattu teräs tai mattamessinki ·  
patyna, nikiel mat lubmosiądz mat



04 | Altmessing · old brass



07 | Nickel matt · nickel mat



08 | Messing matt · brass mat



32 | Schwarz matt · black mat



Tischleuchte · Table lamp  
↓ 35 cm, ↔ 18 cm, ∠ max. 15 cm  
incl. SMD-LED, 4 W  
380 lm, 3.000 K



579790104  
579790107  
579790108  
579790108



Wandleuchte · Wall lamp  
↓ 35 cm, ↔ 18 cm, ∠ max. 35 cm  
incl. SMD-LED, 4 W  
380 lm, 3.000 K



279770104  
279770107  
279770108  
279770108



Integrierter Dimmer ·  
Integrated dimmer





# POLO

Kunststoff · plastic · plastique · kunststof · plástico · plastica · plastic · muovi · plastik



Lichtfarbe einstellbar · Adjustable light color



4 fach TOUCH · 4 level Touch function



## Tischleuchte · Table lamp

↑ 41 cm, ↗ 40 cm  
incl. 1 x SMD-LED, 5 W  
550 lm, 3.000 + 4.000 + 5.000 K



527090111 | Grau · grey  
527090131 | Weiß matt · white mat



# POLLY

Kunststoff · plastic · plastique · kunststof · plástico · plastica · plastic · muovi · plastik



4 fach TOUCH · 4 level Touch function



## Tischleuchte · Table lamp

↑ 40 cm, ↔ 16 x 16 cm, ↗ 39 cm  
incl. 1 x SMD, 4,8 W  
700 lm, 3.000 K



573910101 | Weiß · white  
573910106 | Chrom · chrome



# LUPO

Kunststoff · plastic · plastique · kunststof · plástico · plastica · plastic · muovi · plastik



4 fach TOUCH · 4 level Touch function



01 | Weiß · white



02 | Schwarz · black



## Tischleuchte · Table lamp

↑ 35 cm, Ø 13,5 cm, ↗ 30 cm  
incl. 1 x SMD-LED, 5 W  
550 lm, 3.500 K



527290101  
527290102







# KIMI

Metall, Holz · metal, wood ·  
metale, bois · metaal, hout · metal, madera ·  
metallo, di legno · metal, lemn · metalli, puu · metal, drewno

Empfohlen:  
recommended: LED E27, 4 W  
320 lm, 3.000 K



986-40



Tischleuchte · Table lamp  
↑ max. 50 cm, Ø 16 cm, ↗ max. 37,5 cm  
excl. 1 x E27, max. 42 W



508300131 | Weiß matt · white mat  
508300132 | Schwarz matt · black mat



# PERRY

Metall · metal ·  
metale · metaal · metal · metallo · metal · metalli · metal

Empfohlen:  
recommended: LED E27, 4,9 W  
470 lm, 3.000 K



987-60



Tischleuchte · Table lamp  
↑ 46 cm, ↔ 16 cm, ↗ 28 cm  
excl. 1 x E27, max. 42 W



504900104 | Altmessing · old brass  
504900107 | Nickel matt · nickel mat  
504900131 | Weiß matt · white mat  
504900132 | Schwarz matt · black mat



# PRONTO

Metall, Kunststoff · metal, plastic ·  
metale, plastique · metaal, kunststof · metal, plástico ·  
metallo, plastica · metal, plastic · metalli, muovi · metal, plastik

 **01** | Weiß · white

 **17** | mehrfarbig · multicolor

 **47** | silberfarbig · silver-coloured



496

Tischleuchte · Table lamp  
↑ 30 cm, Ø 13,1 cm, √ 22 cm  
excl. 1 x E27, max. 18 W



5027011-01  
5027011-17  
5027011-47

497

# FLEXO

Metall, Kunststoff · metal, plastic ·  
metale, plastique · metaal, kunststof · metal, plástico ·  
metallo, plastica · metal, plastic · metalli, muovi · metal, plastik

 **01** | Weiß · white

 **02** | Schwarz · black

 **17** | mehrfarbig · multicolor

 **47** | silberfarbig · silver-coloured

Tischleuchte · Table lamp  
↑ 30 cm, √ 30 cm  
excl. 1x E14, max. 18 W





5028010-01  
5028010-02  
5028010-17  
5028010-47



# TAJO

Metall · metal ·  
metale · metaal · metal ·  
metallo · metal · metalli · metal

 **01** | Weiß · white

 **47** | silberfarbig · silver-coloured



Tischleuchte · Table lamp  
↑ 73,5 cm, Ø 16,8 cm, √ 51 cm  
excl. 1 x E27, max. 40 W



5029010-01  
5029010-47





## Spotserien

- Spots
- Spotterie
- Spots
- Focos
- Faretti
- Spoturi
- Spotit
- Reflektorki



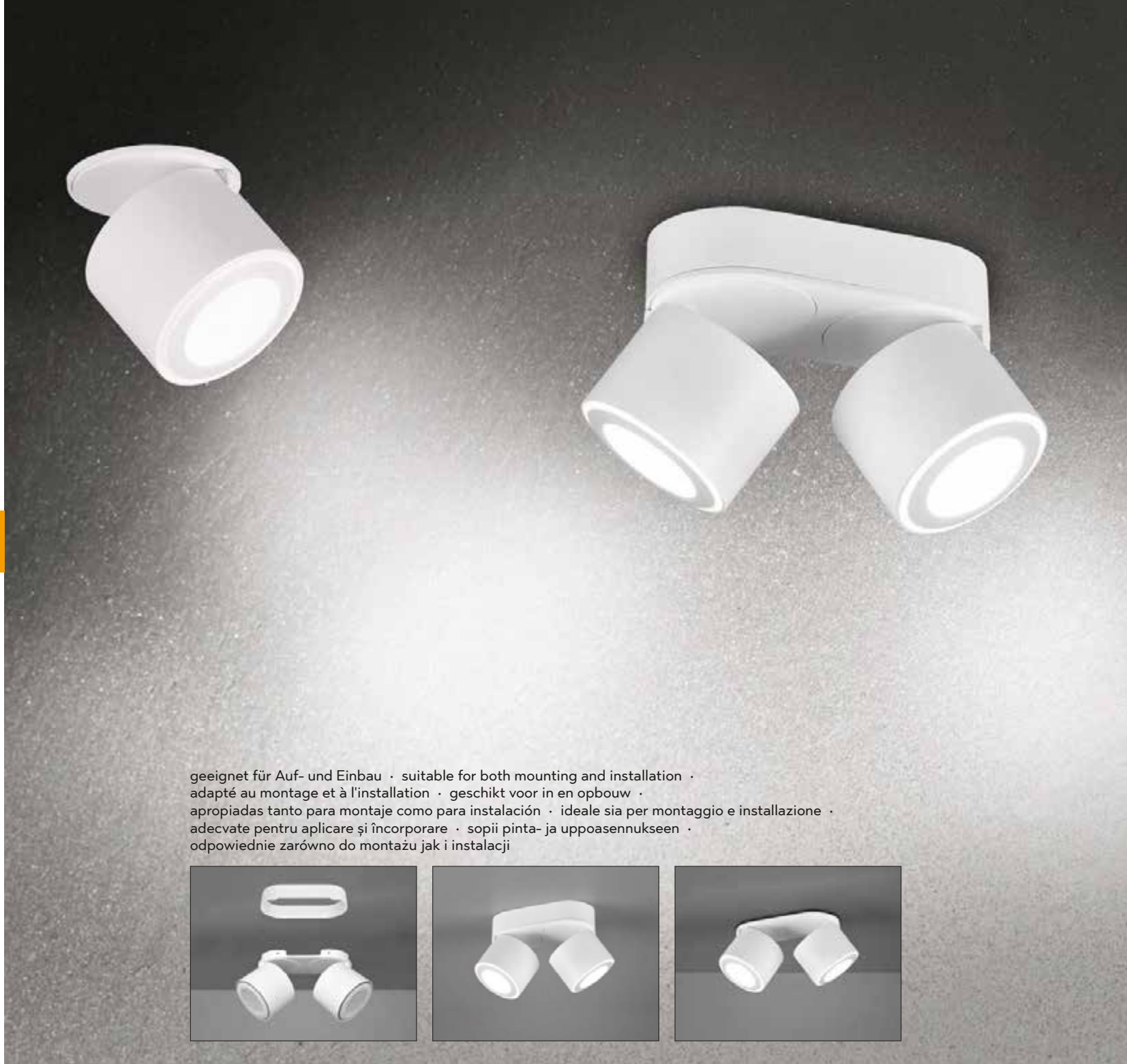

geeignet für Auf- und Einbau · suitable for both mounting and installation · adapté au montage et à l'installation · geschikt voor in en opbouw · apropiadas tanto para montaje como para instalación · ideale sia per montaggio e installazione · adecvate pentru aplicare și încorporare · sopii pinta- ja uppoasennukseen · odpowiednie zarówno do montażu jak i instalacji

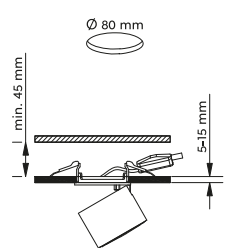

**Strahler · Spot**  
 Ø 8,7 cm, ↑ 10,6 cm  
 incl. SMD-LED, 5 W  
 450 lm, 3.000 K  
 incl. SMD-LED, 1,5 W  
 110 lm, 3.000 K

652910131  
 652910132

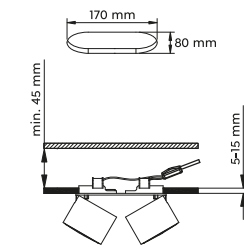

**Strahler · Spot**  
 ↔ 18 x 8,7 cm, ↑ 10,6 cm  
 incl. 2 x SMD-LED, 5 W  
 2 x 450 lm, 3.000 K  
 incl. 2 x SMD-LED, 1,5 W  
 2 x 110 lm, 3.000 K

652910231  
 652910232

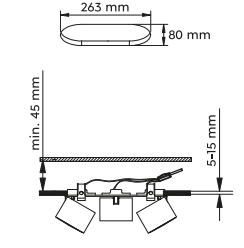

**Strahler · Spot**  
 ↔ 27,3 x 8,7 cm, ↑ 10,6 cm  
 incl. 3 x SMD-LED, 5 W  
 3 x 450 lm, 3.000 K  
 incl. 3 x SMD-LED, 1,5 W  
 3 x 110 lm, 3.000 K

652910331  
 652910332

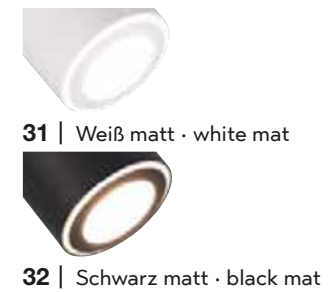

31 | Weiß matt · white mat

32 | Schwarz matt · black mat

# TAURUS

Metall, Weiß matt oder Schwarz matt · metal, white mat or black mat ·  
 metale, blanc mat ou noir mat · metaal, wit mat of mat zwart · metal, estera blanca o estera negra ·  
 metallo, bianco opaco o nero opaco · metal, alb mat sau negru mat · metalli, valkoinen matto tai musta matto · metal, biały mat lub czarny mat

Getrennt schaltbar · Separately switchable







## CLAPTON

Aluminium gebürstet, Chrom, Glas Weiß gewischt · brushed aluminium, chrome, glass white brushed glass · aluminium balayé, chrome, verre blanc balayé · geborsteld aluminium, chroom, wit geborsteld glas · aluminio pulido, cromo, blanco pulido · alluminio spazzolato, cromo, vetro bianco spazzolato · aluminiu lucios, crom, alb lucios · harjattu alumiini, kromi, lasi harjattu valkoinen · aluminium szczotkowane, chrom, szkło białe otarła



**Strahler · Spot**  
↔ 36 x 7 cm, ↑ 18,5 cm  
incl. 2 x SMD-LED, 4,3 W  
2 x 430 lm, 3.000 K



821470205



**Strahler · Spot**  
↔ 50 x 7 cm, ↑ 18,5 cm  
incl. 3 x SMD-LED, 4,3 W  
3 x 430 lm, 3.000 K



821410305



**Strahler · Spot**  
↔ 96,5 x 8 cm, ↑ 18,5 cm  
incl. 4 x SMD-LED, 4,3 W  
4 x 430 lm, 3.000 K



821410405



**Strahler · Spot**  
↔ max.150 x 8 cm, ↑ 24 cm  
incl. 6 x SMD-LED, 4,3 W  
6 x 430 lm, 3.000 K



821410605



**Strahler · Spot**  
↑ 20 x 7 cm, ∅ 16 cm  
incl. 1 x SMD-LED, 4,3 W  
430 lm, 3.000 K



821470105



**Strahler · Spot**  
↔ 31 x 22 cm, ↑ 18,5 cm  
incl. 4 x SMD-LED, 4,3 W  
4 x 430 lm, 3.000 K



821430405



**Strahler · Spot**  
↔ 70 x 50 cm, ↑ 23 cm  
incl. 5 x SMD-LED, 4,3 W  
5 x 430 lm, 3.000 K



621410505





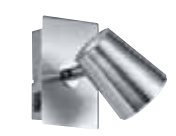

**Strahler · Spot**  
 ↓ 12 x 7,5 cm, ∅ 16 cm  
 incl. SMD-LED, 6,5 W  
 650 lm, 3.000 K



873170107  
 873170131



**Strahler · Spotp**  
 ↔ 28,5 x 9,5 cm, ∅ 16 cm  
 incl. 2 x SMD-LED, 6,5 W  
 2 x 650 lm, 3.000 K



873170207  
 873170231

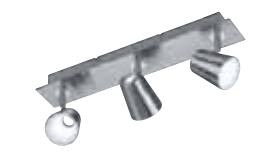

**Strahler · Spot**  
 ↔ 45 x 9,5 cm, ↓ 16 cm  
 incl. 3 x SMD-LED, 6,5 W  
 3 x 650 lm, 3.000 K



873110307  
 873110331

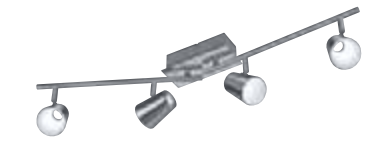

**Strahler · Spot**  
 ↔ 81,5 x 8 cm, ↓ 20 cm  
 incl. 4 x SMD-LED, 6,5 W  
 4 x 650 lm, 3.000 K



873110407  
 873110431

# NARCOS

Nickel matt oder weiß · nickel mat or white ·  
 nickel mat ou blanc · nikkell mat of wit · níquel mate o blanco · nichel opaco o bianco ·  
 nichel mat sau alb · harjattu teräs tai valkoinen · nikiel mat lub biały



07 | Nickel matt · nickel mat



31 | Weiß matt · white mat

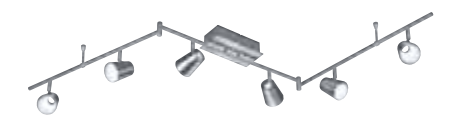

**Strahler · Spot**  
 ↔ 177 x 10 cm, ↓ 23 cm  
 incl. 6 x SMD-LED, 6,5 W  
 6 x 650 lm, 3.000 K



873110607  
 873110631



**Tischleuchte · Table lamp**  
 ↓ 38 cm, ∅ 23 cm  
 incl. SMD-LED, 4,7 W  
 470 lm, 3.000 K



573190107  
 573190131



**Stehleuchte · Floor lamp**  
 ↓ 154 cm, ↔ 28 cm  
 incl. 3 x SMD-LED, 4,7 W  
 3 x 470 lm, 3.000 K



473190307  
 473190331







## PAGO

Metall, Weiß matt oder Schwarz matt · metal, white mat or black mat ·  
 metale, blanc mat ou noir mat · metaal, wit mat of mat zwart ·  
 metal, estera blanca o estera negra · metallo, bianco opaco o nero opaco ·  
 metal, alb mat sau negru mat · metalli, valkoinen matto tai musta matto ·  
 metal, biały mat lub czarny mat

Empfohlen:  
 recommended: LED GU10, 4,5 W  
 345 lm, 3.000 K



956-55



31 | Weiß matt · white mat



32 | Schwarz matt · black mat



Strahler · Spot  
 Ø 10 cm, 15 cm  
 excl. 1 x GU10, max. 35 W



803500131  
 803500132



Strahler · Spot  
 ↔ 24 x 7 cm, ↓ 15 cm  
 excl. 2 x GU10, max. 35 W



803500231  
 803500232



Strahler · Spot  
 ↔ 41 x 7 cm, ↓ 15 cm  
 excl. 3 x GU10, max. 35 W



803500331  
 803500332



Strahler · Spot  
 ↔ 24 x 24 cm, ↓ 15 cm  
 excl. 4 x GU10, max. 35 W



803590431  
 803590432





## LEON

Nickel matt, Weiß matt oder Schwarz matt · nickel mat, white mat or black mat ·  
 nickel mat, blanc mat ou noir mat · nikkell mat, wit mat of mat zwart ·  
 níquel mate, estera blanca o estera negra · nichel opaco, bianco opaco o nero opaco ·  
 nichel mat, alb mat sau negru mat · harjattu teräs, valkoinen matto tai musta matto ·  
 nikiel mat, biały mat lub czarny mat



Strahler · Spot  
 ↔ 11 x 16 cm, ℓ 19 cm  
 excl. 1 x GU10, max. 35 W



800700107  
 800700131  
 800700132



Strahler · Spot  
 ↔ 28 x 16 cm, ℓ 19 cm  
 excl. 2 x GU10, max. 35 W



800700207  
 800700231  
 800700232



Strahler · Spot  
 ↔ 44 x 16 cm, ℓ 19 cm  
 excl. 3 x GU10, max. 35 W



800700307  
 800700331  
 800700332



Strahler · Spot  
 ↔ 60 x 16 cm, ℓ 19 cm  
 excl. 4 x GU10, max. 35 W



800700407  
 800700431  
 800700432

Empfohlen:  
 recommended: LED GU10, 4,5 W  
 345 lm, 3.000 K



956-55



07 | Nickel matt · nickel mat



31 | Weiß matt · white mat



32 | Schwarz matt · black mat





Empfohlen:  
recommended: LED GU10, 4,5 W  
345 lm, 3.000 K



956-55



# MARLEY

Metall, Schwarz-Gold · metal, black-gold ·  
métal, noir et or · metaal, zwart-goud · metal, negro-oro ·  
metallo, oro nero · metal, negru-auriu · metalli, musta-kulta · metal, czarno złoty



Strahler · Spot  
↓ 12 x 12 cm, ↗ 15 cm  
excl. 1 x GU10, max. 25 W



802400180



Strahler · Spot  
↔ 30 x 9 cm, ↓ 15 cm  
excl. 2 x GU10, max. 35 W



802400280



Strahler · Spot  
↔ 48 x 9 cm, ↓ 15 cm  
excl. 3 x GU10, max. 35 W



802400380



Strahler · Spot  
↔ 24 x 24 cm, ↓ 15 cm  
excl. 4 x GU10, max. 35 W



802430480

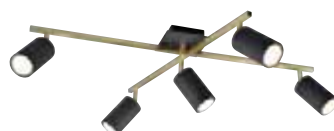

Strahler · Spot  
↔ 77,4 x 57,4 cm, ↓ 22,4 cm  
excl. 5 x GU10, max. 35 W



612400580





# MARLEY

Metall · metal ·  
metale · metaal · metal · metallo · metal · metalli · metal



**Strahler · Spot**  
↑ 12 x 12 cm, ∠ 15 cm  
excl. 1 x GU10, max. 25 W



802400101  
802400124  
802400132



**Strahler · Spot**  
↔ 30 x 9 cm, ↑ 15 cm  
excl. 2 x GU10, max. 35 W



802400201  
802400224  
802400232



**Strahler · Spot**  
↔ 48 x 9 cm, ↑ 15 cm  
excl. 3 x GU10, max. 35 W



802400301  
802400324  
802400332



**Strahler · Spot**  
↔ 77,4 x 57,4 cm, ↑ 22,4 cm  
excl. 5 x GU10, max. 35 W



612400501  
612400532

Empfohlen:  
recommended: LED GU10, 4,5 W  
345 lm, 3.000 K



956-55



**01** | Weiß · white



**24** | rostfarbig · rusty



**32** | Schwarz matt · black mat



**Wandleuchte · Wall lamp**  
↑ 18 x 6 cm, ∠ 8 cm  
excl. 2 x GU10, max. 35 W



212400201  
212400224  
212400232



**Strahler · Spot**  
↔ 24 x 24 cm, ↑ 15 cm  
excl. 4 x GU10, max. 35 W



802430401  
802430424  
802430432





# MARLEY

Metall · metal ·  
metale · metaal · metal · metallo · metal · metalli · metal



**Strahler · Spot**  
↔ 12 cm, ↑ 12 cm, ↗ 15 cm  
excl. 1 x GU10, max. 25 W

 **802400104**  
**802400107**



**Strahler · Spot**  
↔ 30 x 9 cm, ↑ 15 cm  
excl. 2 x GU10, max. 35 W

 **802400204**  
**802400207**



**Strahler · Spot**  
↔ 48 x 9 cm, ↑ 15 cm  
excl. 3 x GU10, max. 35 W

 **802400304**  
**802400307**



**Strahler · Spot**  
↔ 24 x 24 cm, ↑ 15 cm  
excl. 4 x GU10, max. 35 W

 **802430404**  
**802430407**

Empfohlen:  
recommended: LED GU10, 4,5 W  
345 lm, 3.000 K

 **956-55**





**04** | Altmessing · old brass



**07** | Nickel matt · nickel mat



**Wandleuchte · Wall lamp**  
↑ 18 cm, ↔ 6 cm, ↗ 8 cm  
excl. 2 x GU10, max. 35 W

  **212400204**  
**212400207**



**Strahler · Spot**  
↔ 77,4 x 57,4 cm, ↑ 22,4 cm  
excl. 5 x GU10, max. 35 W

  **612400504**  
**612400507**



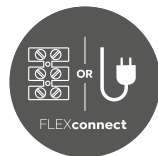
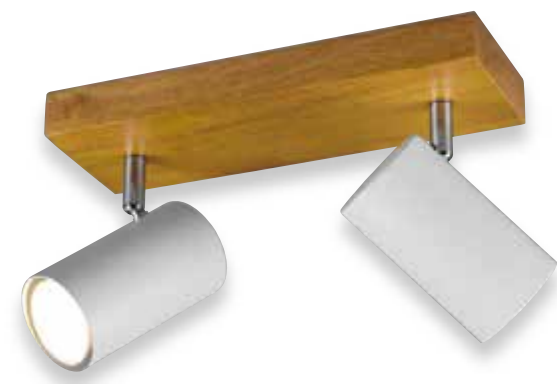
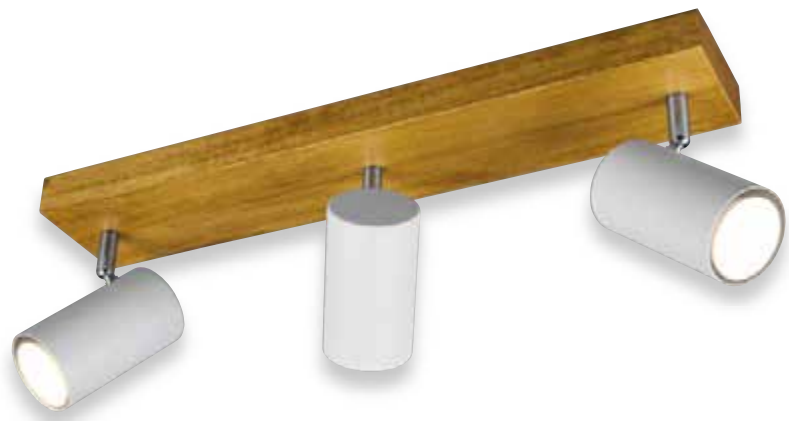

Seite/page 632



# MARLEY

Metall, Holz · metal, wood ·  
metale, bois · metaal, hout · metal, madera ·  
metallo, di legno · metal, lemn · metalli, puu · metal, drewno



Wandleuchte · Wall lamp  
↔ 12 x 9 cm, ↕ 16 cm  
excl. 1 x GU10, max. 15 W

Deckenleuchte · Ceiling lamp  
↔ 26 x 9 cm, ↕ 16 cm  
excl. 2 x GU10, max. 35 W

Deckenleuchte · Ceiling lamp  
↔ 44 x 9 cm, ↕ 16 cm  
excl. 3 x GU10, max. 35 W

Deckenleuchte · Ceiling lamp  
↔ 22 x 22 cm, ↕ 16 cm  
excl. 4 x GU10, max. 35 W



812400107  
812400131  
812400132



812400207  
812400231  
812400232



812400307  
812400331  
812400332



812400407  
812400431  
812400432

Empfohlen:  
recommended: LED GU10, 4,5 W  
345 lm, 3.000 K



956-55



07 | Nickel matt · nickel mat



31 | Weiß matt · white mat



32 | Schwarz matt · black mat





## CARICO

Nickel matt, Glas Weiß gewischt · nickel mat, glass white brushed glass ·  
 nickel mat, verre blanc balayé · nikkell mat, wit geborsteld glas ·  
 níquel mate, blanco pulido · nichel opaco, vetro bianco spazzolato ·  
 nichel mat, alb lucios · harjattu teräs, lasi harjattu valkoinen ·  
 nikiel mat, szkło białe otarła



Dimmbar ·  
Dimmable



**Strahler · Spot**  
 Ø 9 cm, ℓ 16 cm  
 incl. 1 x LED G9, 3 W  
 250 lm, 3.000 K



871570107



**Strahler · Spot**  
 ↔ 34 cm, ↑ 18 cm  
 incl. 2 x LED G9, 3 W  
 2 x 250 lm, 3.000 K



871510207



**Strahler · Spot**  
 Ø 29,5 cm, ↑ 18 cm  
 incl. 3 x LED G9, 3 W  
 3 x 250 lm, 3.000 K



871590307



**Strahler · Spot**  
 ↔ 90 cm, ↑ 19 cm  
 incl. 4 x LED G9, 3 W  
 4 x 250 lm, 3.000 K



871510407

incl.: LED G9, 3 W  
 250 lm, 3.000 K



**Strahler · Spot**  
 ↔ 150 cm, ↑ 19 cm  
 incl. 6 x LED G9, 3 W  
 6 x 250 lm, 3.000 K



871510607





## LEVISTO

Nickel matt oder Messing matt, Glas alabasterfarbig · nickel mat or brass mat, alabaster-coloured glass · nickel mat ou laiton mat, verre couleur albâtre · nikkell mat of messing mat, albastkleurig glas · níquel mate o bronce mate, vidrio de color alabastro · nichel opaco o ottone satinato, vetro colore alabastro · nichel mat sau bronz mat, sticla culoare alabastru · harjattu teräs tai mattamessinki, lasi alabasteri väri · nikiel mat lub mosiądz mat, szkło alabaster kolor



**Strahler · Spot**  
 Ø 10 cm, √ 19 cm  
 incl. 1 x LED E14, 5 W  
 400 lm, 3.000 K

871010107  
 871010108



**Strahler · Spot**  
 ↔ 33 cm, ↓ 19 cm  
 incl. 2 x LED E14, 5 W  
 2 x 400 lm, 3.000 K

871010207  
 871010208



**Strahler · Spot**  
 ↔ 55 cm, ↓ 19 cm  
 incl. 3 x LED E14, 5 W  
 3 x 400 lm, 3.000 K

871010307  
 871010308



**Strahler · Spot**  
 ↔ 88 cm, ↓ 19 cm  
 incl. 4 x LED E14, 5 W  
 4 x 400 lm, 3.000 K

871010407  
 871010408



**Strahler · Spot**  
 ↔ 180 cm, ↓ 21 cm  
 incl. 6 x LED E14, 5 W  
 6 x 400 lm, 3.000 K

871010607  
 871010608



07 | Nickel matt · nickel mat



08 | Messing matt · brass mat



incl.  
 LED E14, 4,9 W  
 470 lm, 3.000 K

983-60



**Strahler · Spot**  
 Ø 30 cm, ↓ 21 cm  
 incl. 3 x LED E14, 5 W  
 3 x 400 lm, 3.000 K

871090307  
 871090308





## MICHAEL

Nickel matt · nickel mat ·  
nickel mat · nikkell mat · níquel mate · nichel opaco ·  
nichel mat · harjattu teräs · nikiel mat · mat nikel



**Strahler · Spot**  
↑ 10,6 x 6 cm, √ 13 cm  
excl. 1 x GU10, max. 28 W



803000107



**Strahler · Spot**  
↔ 32 x 5 cm, ↑ 13 cm  
excl. 2 x GU10, max. 28 W



803000207



**Strahler · Spot**  
↔ 54 x 5 cm, ↑ 13 cm  
excl. 3 x GU10, max. 28 W



803000307



**Strahler · Spot**  
Ø 25,5 cm, ↑ 15 cm  
excl. 3 x GU10, max. 28 W



803090307

Empfohlen:  
recommended: LED GU10, 4,5 W  
345 lm, 3.000 K



956-55







Empfohlen:  
recommended: LED GU10, 4,5 W  
345 lm, 3.000 K



956-55



Empfohlen:  
recommended: Filament LED E14, 4 W  
470 lm, 3.000 K



989-400

# CONCRETE

Beton, Grau · concrete, grey ·  
béton, gris · beton, grijs · hormigón, gris · cemento, grigio ·  
beton, gri · betoni, harmaa · beton, popielaty · beton, gri



Strahler · Spot  
↔ 10 x 15 cm, ↗ 18 cm  
excl. 1 x GU10, max. 42 W



802500178



Strahler · Spot  
↔ 23 x 10 cm, ↑ 18 cm  
excl. 2 x GU10, max. 42 W



802500278



Strahler · Spot  
↔ 35 x 10 cm, ↑ 18 cm  
excl. 3 x GU10, max. 42 W



802500378

# HOUSTON

Metall, Schwarz/goldfarbig · metal, black/gold ·  
metalle, noir/ro · metaal, zwart/goud · metal, negro/oro ·  
metallo, nero/oro · metal, negru/aur · metalli, musta/kultaa ·  
metal, czarny/zlota



Strahler · Spot  
↔ 9,5 x 12 cm, ↗ 17 cm  
excl. 1 x E14, max. 40 W



800300132



Strahler · Spot  
↔ 36,5 cm, ↑ 19 cm  
excl. 2 x E14, max. 40 W



800300232



Strahler · Spot  
↔ 69,5 cm, ↑ 19 cm  
excl. 4 x E14, max. 40 W



800300432







Seite/page 632



# ROXIE

Metall, weiß matt oder schwarz matt, Chrom · metal, white mat or black mat, chrome · Métal, Blanc mat ou Noir mat, Chrome · Metaal, Wit mat of Mat zwart, Chrom · Metal, Estera blanca o Estera negra, Cromo · Metallo, Bianco opaco o Nero opaco, Cromo · Metal, Alb mat sau Negru mat, Crom · Metalli, mattavalkoinen tai mattamusta, Kromi · Metal, Biały mat lub Czarny mat, Chrom

Empfohlen:  
recommended: Filament LED E14, 4 W  
470 lm, 2.700 K



983-400



**Strahler · Spot**  
↑ 22,7 cm, ↔ 10 cm, ↗ 15,7 cm  
excl. 1 x E14, max. 40 W



811900131  
811900132



**Strahler · Spot**  
↔ 40 x 13,8 cm, ↑ 22,8 cm  
excl. 2 x E14, max. 40 W



811900231  
811900232



**Strahler · Spot**  
↔ 57 x 13,8 cm, ↑ 22,8 cm  
excl. 3 x E14, max. 40 W



811900331  
811900332



31 | Weiß matt · white mat

32 | Schwarz matt · black mat



**Tischleuchte · Table lamp**  
↑ 43 cm, ↔ 17 cm, ↗ 22,5 cm  
excl. 1 x E14, max. 40 W



511900131  
511900132



**Stehleuchte · Floor lamp**  
↑ 155 cm, ↔ 43 cm, ↗ 23 cm  
excl. 2 x E14, max. 40 W



411900231  
411900232



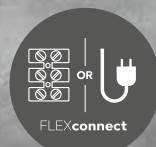

Seite/page 632

Empfohlen:  
recommended: Filament LED E14, 4 W  
470 lm, 2.700 K



983-400



# STEAM

Metall, Weiß antik · metal, antique white ·  
Métal, Blanc antique · Metaal, Antiek wit · Metal, Blanco decapé ·  
Metallo, Bianco anticato · Metal, Alb antic · Metalli, Antiikkivalkoinen ·  
Metal, Antyczny biały



**Strahler · Spot**  
↓ 14 cm, ↔ 10 cm, ↗ 15 cm  
excl. 1 x E14, max. 40 W



813400127



**Strahler · Spot**  
↔ 30 x 10 cm, ↓ 17,5 cm  
excl. 2 x E14, max. 40 W



813400227



**Strahler · Spot**  
↔ 73 x 10 cm, ↓ 17,5 cm  
excl. 4 x E14, max. 40 W



813400427



**Strahler · Spot**  
Ø 30 cm, ↓ 15,5 cm  
excl. 3 x E14, max. 40 W



813430327



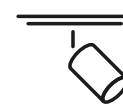

## 2-Phasen- Schienensystem

2-phase track system  
Système de voie à deux phases  
2-fase-spoorsysteem  
Sistema de rieles en 2 fases  
Sistema a binario bifase  
Sistem de piste cu 2 faze  
2-vaihekiskojärjestelmä  
2-fazowy system prowadnic





### Für jede Raumsituation die ideale Beleuchtung.

Das DUOline 2-Phasen-Schiensystem ist äußerst flexibel und bietet zahlreiche Möglichkeiten zur individuellen Lichtgestaltung. Die verschiedenen Spots und Pendelleuchten lassen sich frei in der Schiene platzieren und können so gezielt in allen Wohnbereichen eingesetzt werden. Das 2-Phasensystem ermöglicht, dass mit nur einem Stromanschluss zwei Beleuchtungsgruppen getrennt voneinander geschaltet oder gedimmt werden können.

Bitte beachten! Um das 2-Phasensystem nutzen zu können, wird eine vieradrige Stromleitung benötigt.

### The ideal lighting for every room situation.

The DUOline 2-phase track system is extremely flexible and offers numerous possibilities for individual lighting arrangements. The various spotlights and pendant lamps can be positioned as desired in the track and can therefore be used in all living areas. The 2-phase system allows two lighting groups to be switched or dimmed independently of each other with just one power connection.

Please note! A four-core power cable is required to be able to use the 2-phase system.

### L'éclairage parfait pour chaque type de pièces.

Le système de rails biphasés DUOline est extrêmement flexible et offre de nombreuses possibilités de conception individuelle de l'éclairage. Les différents projecteurs et luminaires suspendus peuvent être positionnés librement dans le rail et peuvent donc être utilisés de manière spécifique dans tous vos espaces d'habitation. Le système biphasé permet de commuter ou de faire varier l'intensité de deux groupes d'éclairage séparément l'un de l'autre avec un seul branchement électrique.

Attention ! Un câble d'alimentation à quatre conducteurs est nécessaire pour utiliser le système biphasé.

### Voor elke situatie de ideale verlichting.

Het DUOline-2-fase-spoorsysteem is uiterst flexibel en biedt talrijke mogelijkheden voor een individuele lichtvormgeving. De diverse spots en hanglampen kunnen willekeurig in het spoor geplaatst worden en kunnen zo doelgericht in alle woonruimtes gebruikt worden. Het 2-fase-systeem maakt mogelijk dat met slechts één stroomaansluiting twee verlichtingsgroepen apart van elkaar geschakeld of gedimd kunnen worden.

Opgelet! Om het 2-twee-fasesysteem te kunnen gebruiken is een vierdradige stroomleiding nodig.

### La iluminación ideal para cada habitación.

El sistema de rieles en 2 fases DUOline es extraordinariamente flexible y ofrece numerosas posibilidades de diseño lumínico individuales. Los distintos puntos y lámparas de péndulo le permiten colocar los rieles libremente y por eso pueden utilizarse en toda la vivienda. El sistema de rieles en 2 fases permite que se activen o atenúen dos grupos de lámparas separados con un solo cable de corriente.

¡Por favor, recuerde! Para poder utilizar el sistema en 2 fases, será necesario un cable de corriente de cuatro filamentos.

### L'illuminazione ideale per qualsiasi esigenza abitativa.

Il sistema a binario bifase DUOline è estremamente flessibile e offre numerose possibilità per la progettazione individuale dell'illuminazione. I vari faretti e lampade a sospensione possono essere posizionati liberamente nel binario e possono quindi essere utilizzati in modo specifico in tutti gli ambienti abitativi. Il sistema bifase consente di commutare o dimmerare due gruppi di illuminazione separatamente l'uno dall'altro con una sola connessione di alimentazione.

Attenzione! Per utilizzare il sistema bifase è necessario un cavo di alimentazione a quattro conduttori.

### Iluminatul ideal pentru fiecare încăpere.

Sistemul de piste cu 2 faze DUOline este deosebit de flexibil și oferă numeroase posibilități pentru structurarea individuală a luminii. Diferitele spot-uri și lustre pot fi amplasate liber pe pistă și pot fi astfel utilizate țintit în toate zonele spațiilor de locuit. Sistemul cu 2 faze permite comutarea și reglarea intensității pentru două grupuri de corpuri de iluminat separate, folosind un singur racord electric.

Vă rugăm să aveți în vedere! Pentru a putea utiliza sistemul cu 2 faze, este necesară utilizarea unui cablu electric cu patru fire.

### Ihanteellinen valaistus jokaiseen huoneen käyttötilanteeseen.

DUOline 2-vaihekiskojärjestelmä on erittäin joustava ja tarjoaa lukuisia vaihtoehtoja yksilölliseen valaistuksen suunnitteluun. Eri spotti- ja ripustettavat valaisimet voidaan sijoittaa mihin tahansa kiskoon, joten niitä voidaan käyttää kaikissa asuintiloissa. 2-vaihejärjestelmä mahdollistaa kahden valaistusrhmän kytkemisen tai himmentämisen erikseen yhdellä sähköliitännällä.

Huomaa! Kaksivaihejärjestelmän käyttämiseksi tarvitaan nelijohtiminen sähkönsyöttö.

### Idealne oświetlenie do każdej sytuacji w pomieszczeniu.

Dwufazowy system prowadnic DUOline jest niezwykle elastyczny i oferuje wiele opcji indywidualnego projektowania oświetlenia. Różne skupienia i lampy wiszące można umieścić w dowolnym miejscu na szynie, dzięki czemu można je stosować we wszystkich pomieszczeniach mieszkalnych. System 2-fazowy umożliwia osobne przełączanie lub przyciemnianie dwóch grup oświetlenia za pomocą tylko jednego podłączenia zasilania.

Proszę pamiętać! Dla korzystania z systemu 2-fazowego, wymagana jest czteroprzewodowa linia zasilania.



# ÜBERSICHT KOMPONENTEN

Component overview · Aperçu des composants · Overzicht van componenten · Vista general por componentes · Panoramica dei componenti · Prezentare generală a componentelor · Komponentteihin yleiskuvaus · Przegląd komponentów

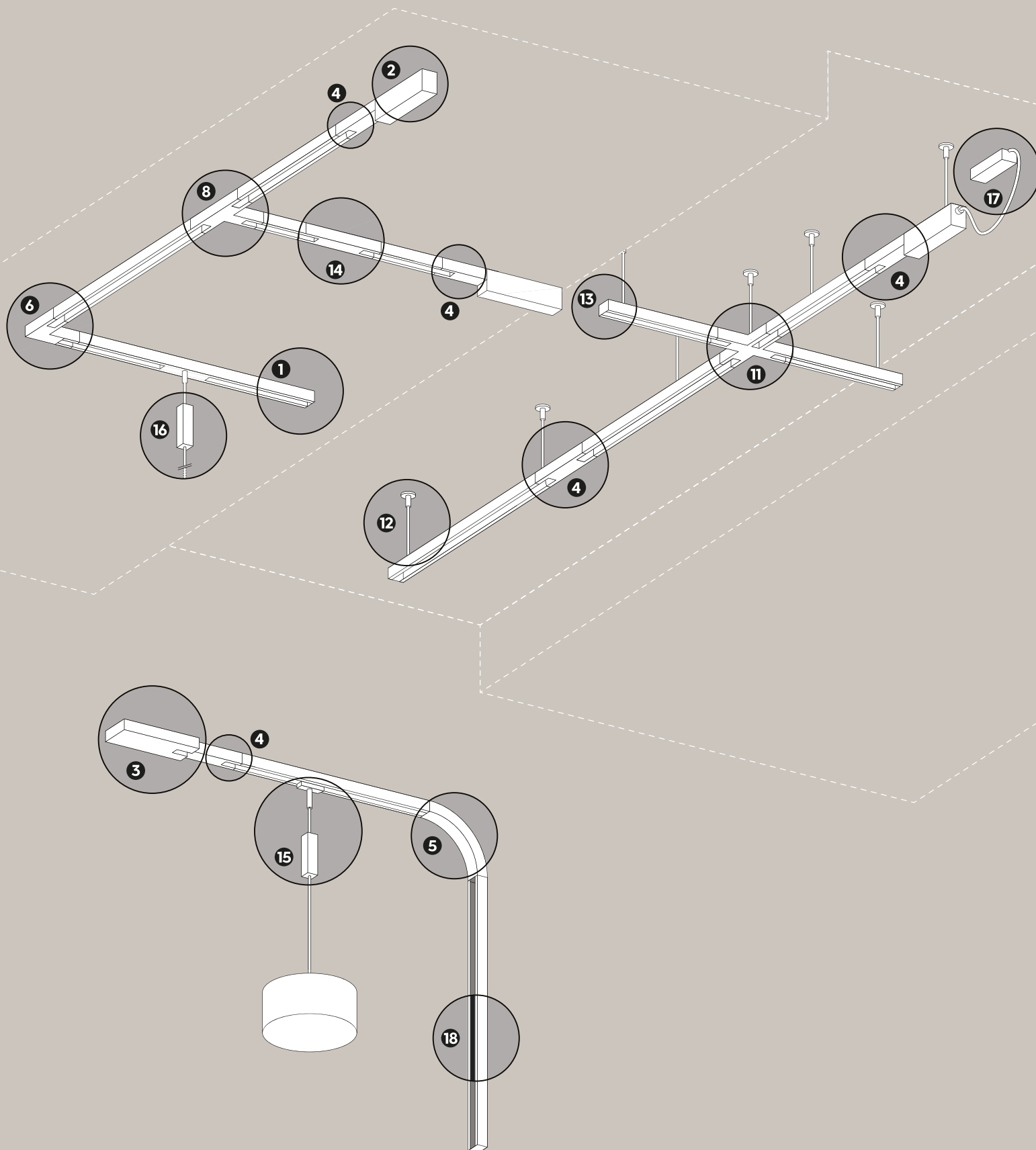

## Die Vorteile von DUOLINE im Überblick:

- Individuelle Lichtgestaltung
- Nur ein Stromanschluss erforderlich
- Kein Trafo notwendig
- Leuchten frei kombinierbar und leicht versetzbar
- Zwei verschiedene Lichtszenarien
- Getrenntes Schalten und Dimmen
- Für Decken- und Wandmontage geeignet

Bei der Planung bitte unbedingt die Position des Schutzleiters beachten, der innerhalb des Systems durchgängig verbunden sein muss.

## Advantages of DUOLINE at a glance:

- individual lighting arrangements
- only one power connection required
- no need for a transformer
- lamps can be freely combined and are easily positioned
- two different lighting scenarios
- separate switching and dimming
- suitable for ceilings and walls

When planning, please pay attention to the position of the protective conductor, which must be connected continuously within the system.

## Les avantages de DUOLINE en un coup d'œil :

- Conception individuelle de l'éclairage
- Une seule connexion électrique requise
- Pas besoin de transformateur
- Les luminaires peuvent être librement combinés et facilement déplacés
- Deux scénarios lumineux différents
- Commutation et variateur de lumière séparés
- Convient pour le montage au plafond et au mur

Lors de la planification, veuillez prêter une attention particulière à la position du conducteur de protection, qui doit être connecté en permanence dans le système.

## Overzicht van de voordelen van DUOLINE:

- Individuele lichtvormgeving
- Slechts één stroomaansluiting nodig
- Geen transformator nodig
- Lampen willekeurig combineerbaar en gemakkelijk verplaatsbaar
- Twee verschillende lichtscenario's
- Apart schakelen en dimmen
- Geschikt voor plafond- en muurmontage

Let bij de planning absoluut op de positie van de beschermende geleider die binnen het systeem ononderbroken verbonden moet zijn.

## Las ventajas de DUOLINE en resumen:

- Diseño lumínico individual
- Solo un cable de corriente necesario
- Ningún transformador necesario
- Lámpara combinables libremente y fácilmente desplazable
- Dos escenarios lumínicos diferentes
- Activación y atenuación separadas
- Adecuado para su montaje en techo y pared

Al planificar, por favor, tenga en cuenta la posición de la toma de tierra, que debe estar conectado a lo largo de todo el sistema.

## I vantaggi di DUOLINE in sintesi:

- Progettazione individuale dell'illuminazione
- È necessario un solo collegamento di alimentazione
- Non è necessario alcun trasformatore
- Le lampade possono essere liberamente combinate e facilmente spostate
- Due differenti scenari di illuminazione
- Commutazione e dimmerazione separate
- Adatto per il montaggio a soffitto e a parete

In fase di progettazione, prestare attenzione alla posizione del conduttore di protezione, che deve essere collegato in modo continuo all'interno dell'impianto.

## Avantajele DUOLINE dintr-o privire:

- Structurarea individualizată a luminii
- Este necesară o singură conexiune electrică
- Nu este necesar un transformator
- Lămpile pot fi combinate liber și pot fi deplasate cu ușurință
- Două scenarii de iluminat diferite
- Comutare și reglare a intensității separate
- Adecvat pentru montajul pe plafon și pe perete

La planificare, luați neapărat în considerare poziția conductorului de protecție, care trebuie să fie conectat continuu în interiorul sistemului.

## DUOLINEN EDUT LYHYESTI:

- Yksilöllinen valaistussuunnittelu
- Vaaditaan vain yksi sähköliitäntä
- Muuntajaa ei tarvita
- Valaisimia voidaan yhdistellä vapaasti ja siirtää helposti
- Kaksi erilaista valaistusskenaariota
- Erillinen kytkentä ja himmennys
- Sopii katto- ja seinäasennukseen

Huomioi suunnittelussa koko järjestelmään kytkettävän suojamaadoituksen sijainti.

## Zalety DUOLINE w skrócie:

- Indywidualny projekt oświetlenia
- Wymagane jest tylko jedno połączenie zasilania
- Nie wymaga transformatora
- Oprawy można dowolnie łączyć i łatwo przemieszczać
- Dwa różne scenariusze oświetlenia
- Oddzielne włączanie i ściemnianie
- Nadaje się do montażu sufitowego i ściennego

Podczas projektowania należy zwrócić uwagę na położenie przewodu ochronnego, który musi być podłączony w całym systemie.



# SCHIENE · TRACK



## 1 SCHIENE 50 CM · TRACKING 50 CM

Metall · metal  
max. 2 x 600 W

700131 | Weiß matt · white mat  
700132 | Schwarz matt · black mat  
700187 | titanfarbig · titan

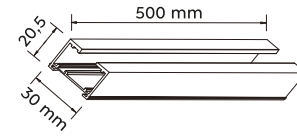

## 1 SCHIENE 100 CM · TRACKING 100 CM

Metall · metal  
max. 2 x 600 W

700231 | Weiß matt · white mat  
700232 | Schwarz matt · black mat  
700287 | titanfarbig · titan

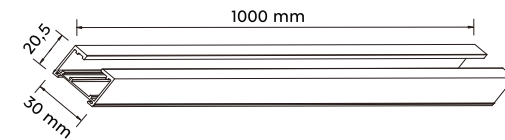

Die maximale Montagelänge beträgt 30 Meter pro Einspeisung, bei einer Gesamtleistung von max. 600 Watt pro Phase.  
The maximum installation length is 30 metres per power feed, with a total capacity of max. 600 watts per phase.

# EINSPEISUNG · POWER SUPPLY



## 2 MITTEL-/END-EINSPEISUNG · MIDDLE-/ENDPOINT POWER SUPPLY

Kunststoff · plastic  
max. 2 x 600 W

701031 | Weiß matt · white mat  
701032 | Schwarz matt · black mat  
701087 | titanfarbig · titan

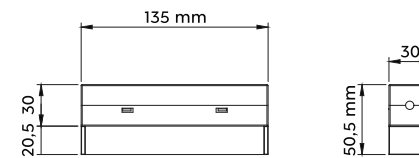

Die Mittel-/Endeinspeisung wird direkt über dem Stromauslass angebracht und ermöglicht, Schienen auf einer Seite oder auf beiden Seiten anzuschließen.  
Zur Stromversorgung der Schienen wird immer ein Verbinder benötigt (Pos. 4-8).  
The middle/end feed is mounted directly over the power outlet and enables tracks to be connected on one or both sides.  
A connector is always required to power the rails (Pos. 4-8).



## 3 MITTEL-/END-EINSPEISUNG MIT ELEKTRONISCHEM PHASENWECHSLER · MIDDLE-/ENDPOINT POWER SUPPLY WITH ELECTRONIC PHASE CHANGER

Kunststoff · plastic  
max. 2 x 200 W

701131 | Weiß matt · white mat  
701132 | Schwarz matt · black mat  
701187 | titanfarbig · titan

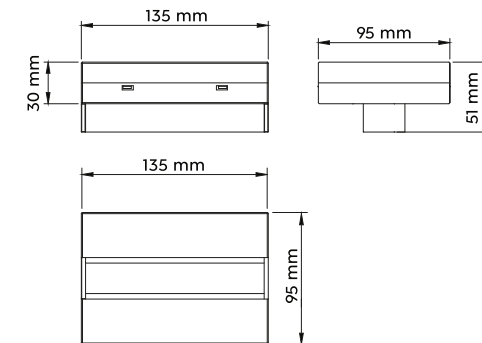

Mittels elektronischem Phasenwechsler lassen sich die zwei Phasen auch bei dreiadrigen Stromleitungen getrennt Schalten und Dimmen.  
Zur Stromversorgung der Schienen wird immer ein Verbinder benötigt (Pos. 4-8).  
Using an electronic phase changer, the two phases can be switched and dimmed separately, even with three-core power cables.  
A connector is always required to power the rails (Pos. 4-8).





# VERBINDER · CONNECTOR



## 4 LÄNGSVERBINDER · LINE CONNECTOR

Kunststoff · plastic  
max. 2 x 600 W

702131 | Weiß matt · white mat  
702132 | Schwarz matt · black mat  
702187 | titanfarbig · titan

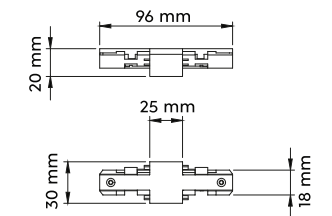

Verbindet zwei Schienen für gerade Strecken miteinander.  
Connects two rails together for straight sections.



## 5 FLEX-VERBINDER · FLEX CONNECTOR

Kunststoff · plastic  
max. 2 x 600 W

702031 | Weiß matt · white mat  
702032 | Schwarz matt · black mat  
702087 | titanfarbig · titan

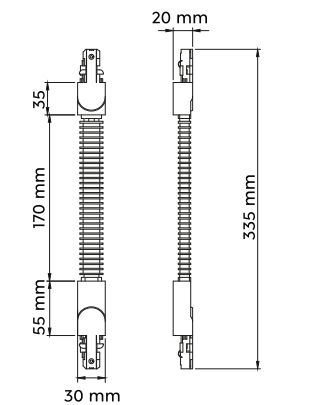

Verbindet zwei Schienen in einem beliebigen Winkel miteinander und ermöglicht die Verbindung zwischen Decken- und Wandmontage.  
Connects two rails together at any angle and makes possible a connection between ceiling and wall mounting.



## 6 L-VERBINDER - SCHUTZLEITER INNEN · L-CONNECTOR - INNER PROTECTIVE CONDUCTOR

Kunststoff · plastic  
max. 2 x 600 W

702231 | Weiß matt · white mat  
702232 | Schwarz matt · black mat  
702287 | titanfarbig · titan

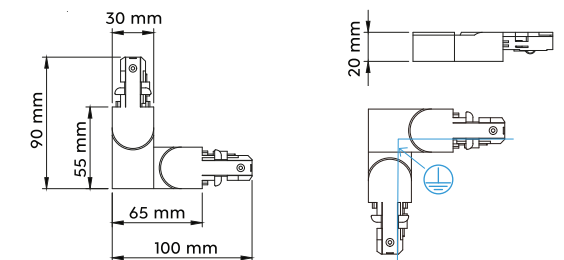

## 7 L-VERBINDER (TYP A) - SCHUTZLEITER AUSSEN · L-CONNECTOR (TYPE A) - OUTER PROTECTIVE CONDUCTO

Kunststoff · plastic  
max. 2 x 600 W

702231A | Weiß matt · white mat  
702232A | Schwarz matt · black mat  
702287A | titanfarbig · titan

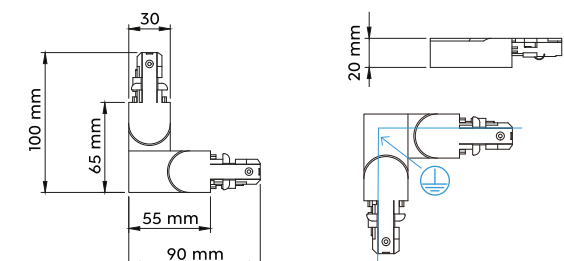

Verbindet zwei Schienen im rechten Winkel miteinander.  
Connects two rails together at right angles.



Bei der Planung bitte unbedingt die Position des Schutzleiters beachten, der innerhalb des Systems durchgängig verbunden sein muss.  
 When planning, please pay attention to the position of the protective conductor, which must be connected continuously within the system.  
 Lors de la planification, veuillez prêter une attention particulière à la position du conducteur de protection, qui doit être connecté en permanence dans le système.  
 Let bij de planning absoluut op de positie van de beschermende geleider die binnen het systeem ononderbroken verbonden moet zijn.  
 Al planificar, por favor, tenga en cuenta la posición de la toma de tierra, que debe estar conectado a lo largo de todo el sistema.  
 In fase di progettazione, prestare attenzione alla posizione del conduttore di protezione, che deve essere collegato in modo continuo all'interno dell'impianto.  
 La planificare, luați neapărat în considerare poziția conductorului de protecție, care trebuie să fie conectat continuu în interiorul sistemului.  
 Huomioi suunnittelussa koko järjestelmään kytkettävän suojausjohtuksen sijainti.  
 Podczas projektowania należy zwrócić uwagę na położenie przewodu ochronnego, który musi być podłączony w całym systemie.

Beispiel A  
 Example A.

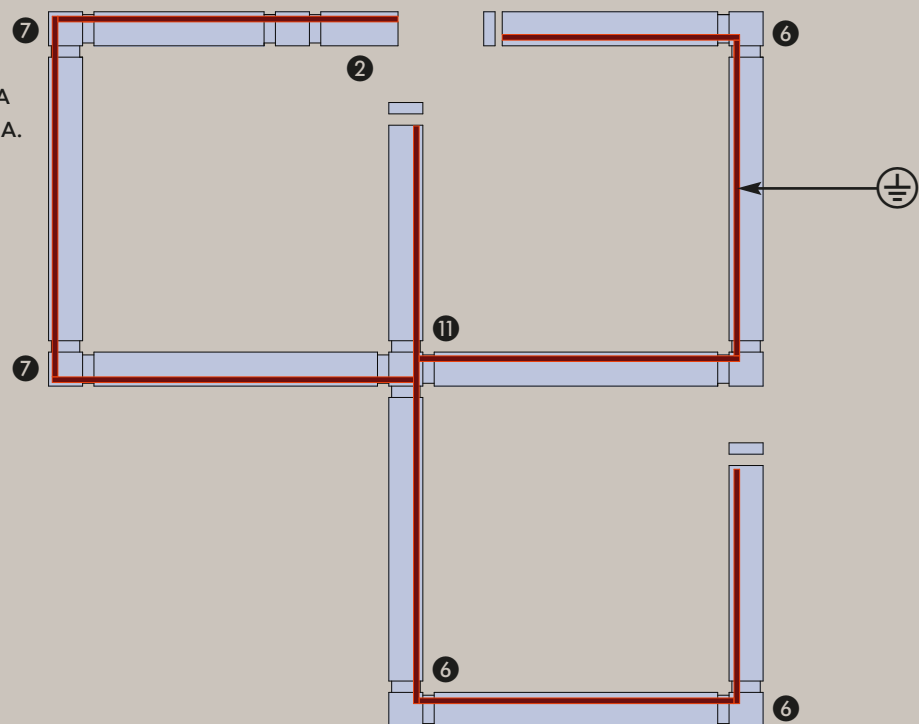

Beispiel B  
 Example B.

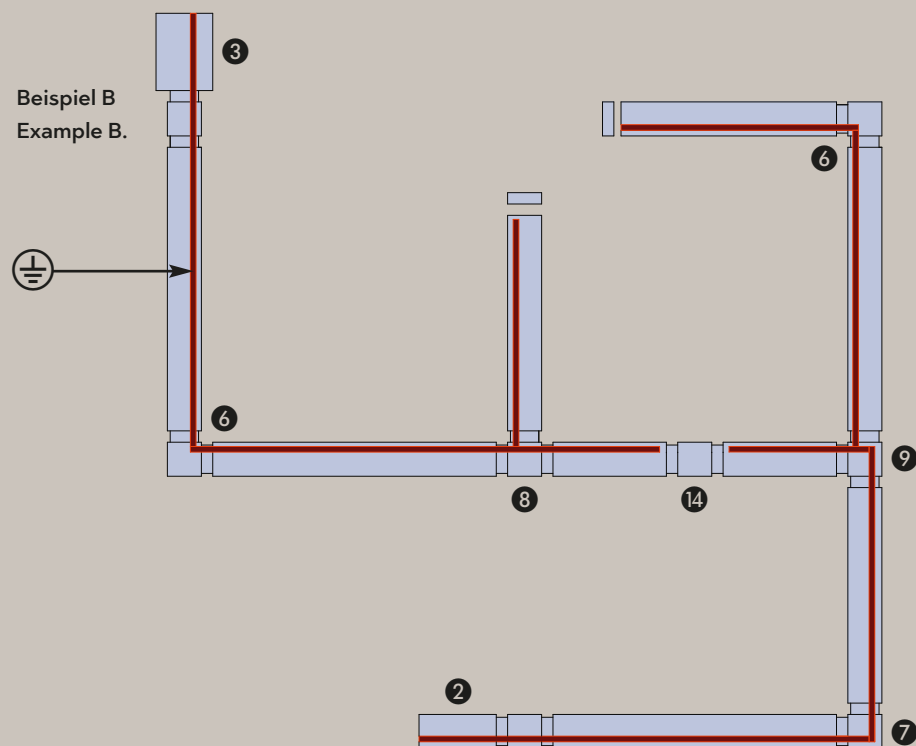

**8 T-VERBINDER - SCHUTZLEITER RECHTS · T-CONNECTOR - RIGHT PROTECTIVE CONDUCTOR**

Kunststoff · plastic  
 max. 2 x 600 W

702331 | Weiß matt · white mat  
 702332 | Schwarz matt · black mat  
 702387 | titanfarbig · titan

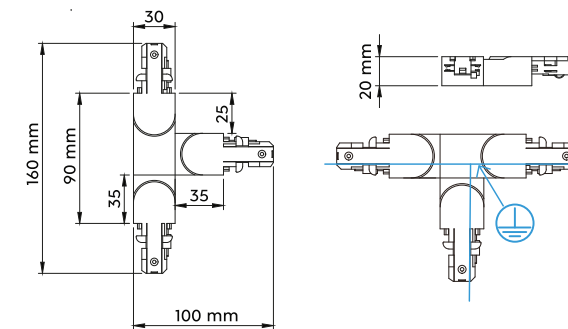

**9 T-VERBINDER (TYP A) - SCHUTZLEITER LINKS · T-CONNECTOR (TYPE A) - LEFT PROTECTIVE CONDUCTOR**

Kunststoff · plastic  
 max. 2 x 600 W

702331A | Weiß matt · white mat  
 702332A | Schwarz matt · black mat  
 702387A | titanfarbig · titan

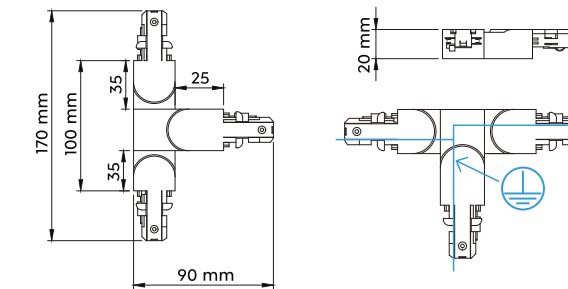

**10 T-VERBINDER (TYP B) - SCHUTZLEITER LINKS · T-CONNECTOR (TYPE B) - LEFT PROTECTIVE CONDUCTOR**

Kunststoff · plastic  
 max. 2 x 600 W

702331B | Weiß matt · white mat  
 702332B | Schwarz matt · black mat  
 702387B | titanfarbig · titan

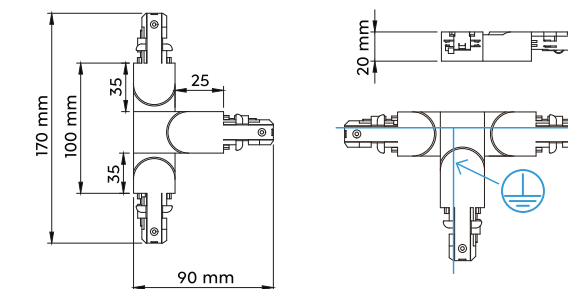

Verbindet drei Schienen im rechten Winkel miteinander.  
 Connects three rails together at right angles.



**11 X-VERBINDER · X-CONNECTOR**

Kunststoff · plastic  
 max. 2 x 600 W

702431 | Weiß matt · white mat  
 702432 | Schwarz matt · black mat  
 702487 | titanfarbig · titan

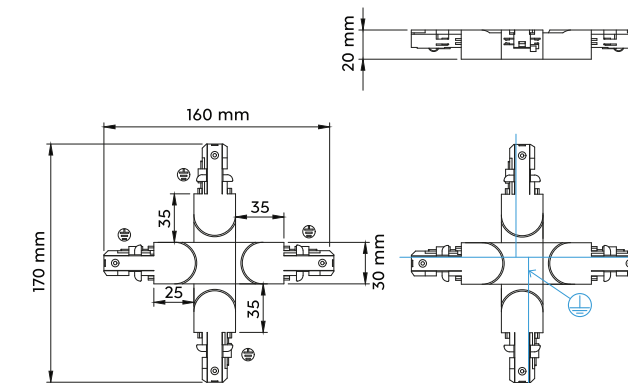

Verbindet vier Schienen im rechten Winkel miteinander.  
 Connects four tracks together at right angles to each other.



# ZUBEHÖR · ACCESSORIES



## 12 DISTANZHALTER SET · SUSPENSION SET

Kunststoff · plastic

- 703131 | Weiß matt · white mat
- 703132 | Schwarz matt · black mat
- 703187 | titanfarbig · titan

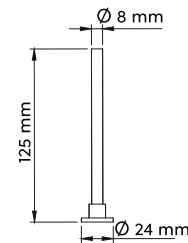

## 12 DISTANZHALTER SET · SUSPENSION SET

Kunststoff · plastic

- 703231 | Weiß matt · white mat
- 703232 | Schwarz matt · black mat
- 703287 | titanfarbig · titan

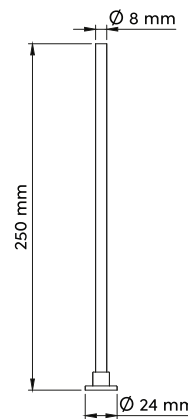

## 13 ENDKAPPEN · END CAPS

Kunststoff · plastic

- 703031 | Weiß matt · white mat
- 703032 | Schwarz matt · black mat
- 703087 | titanfarbig · titan

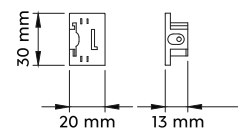

## 14 ISOLATOR · ISOLATOR

Kunststoff · plastic  
max. 2 x 600 W

- 702531 | Weiß matt · white mat
- 702532 | Schwarz matt · black mat
- 702587 | titanfarbig · titan

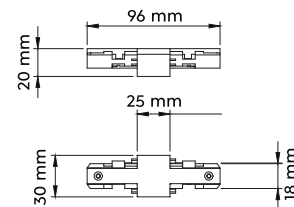

Mittels Isolator können zwei separate Schaltkreise optisch zu einem System verbunden werden.  
Using an isolator, two separate circuits can be optically connected to form one system.



## 15 PENDEL-ADAPTER · PENDULAR ADAPTER

Kunststoff · plastic  
max. 60 W

- 703531 | Weiß matt · white mat
- 703532 | Schwarz matt · black mat
- 703587 | titanfarbig · titan

Dieser Pendel-Adapter ermöglicht es, herkömmliche Pendelleuchten in das DUOline Schienensystem zu integrieren.  
This pendular adapter makes it possible for conventional pendular lamps to be integrated into the DUOline track system.

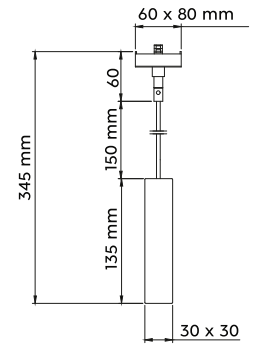

## 16 KABELKÜRZER · CABLE SHORTENER

Kunststoff · plastic

- 703331 | Weiß matt · white mat
- 703332 | Schwarz matt · black mat
- 703387 | titanfarbig · titan

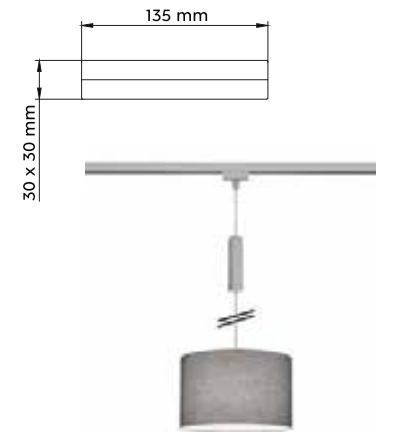

Ermöglicht das Kürzen der Kabel von Pendelleuchten.  
Makes a shortening of the pendal lamp cable possible.



## 17 FLEXIBLE STROMVERSORGUNG · FLEX POWER SUPPLY

Kunststoff · plastic  
max. 2 x 600 W

- 701231 | Weiß matt · white mat
- 701232 | Schwarz matt · black mat
- 701287 | titanfarbig · titan

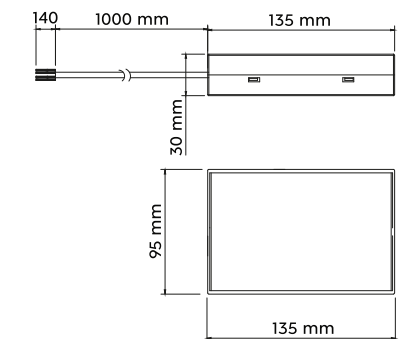

Die flexible Stromversorgung wird benötigt, wenn die Schienen nicht direkt über den Stromauslass verlegt werden können.  
**Nur in Verbindung mit einer Mittel-/Endeinspeisung.**  
The flexible power supply is required if the rails cannot be mounted directly over the power outlet.  
**A connector is always required to power the rails (Pos. 4-8).**

## 18 ABDECKSCHIENE · SAFETY COVER STRIP

Kunststoff · plastic  
↔ 100 x 1,4 cm, ∇ 0,5 cm

- 703952 | Transparent · transparent

## ABDECKPLATTE · COVER PLATE

Metall · metal  
↓ 0,1 cm, Ø 1 cm

- 703431 | Weiß matt · white mat





# RADIATOR

Metall · metal · metale · metaal · metal · metallo · metal · metalli · metal



**STRAHLER · SPOT**  
incl. SMD-LED, 15 W  
1.270 lm, 2.300 + 3.000 + 4.000 K



78030131 | Weiß matt · white mat  
78030132 | Schwarz matt · black mat  
78030187 | titanfarbig · titan

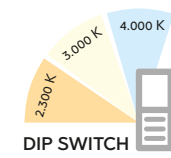
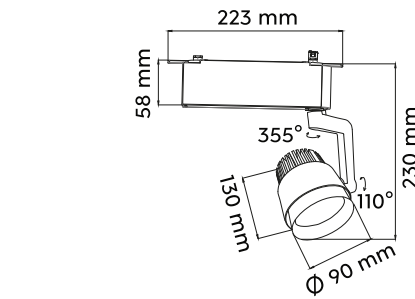

544

# LEON

Metall · metal · metale · metaal · metal · metallo · metal · metalli · metal



**STRAHLER · SPOT**  
excl. 1 x GU10, max. 25 W



78070107 | Nickel matt · nickel mat  
78070131 | Weiß matt · white mat  
78070132 | Schwarz matt · black mat

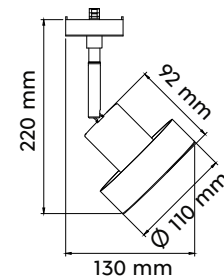

Empfohlen:  
recommended: LED GU10, 5 W  
400 lm, 3.000 K



956-5936

# ROUBAIX

Metall · metal · metale · metaal · metal · metallo · metal · metalli · metal



**STRAHLER · SPOT**  
incl. SMD-LED, 4 W  
400 lm, 3.000 K



78150107 | Nickel matt · nickel mat  
78150131 | Weiß matt · white mat  
78150132 | Schwarz matt · black mat

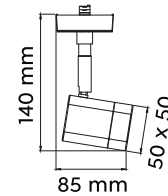

545





# MARLEY

Metall · metal · metale · metaal · metal · metallo · metal · metalli · metal



**STRAHLER · SPOT**  
excl. 1 x GU10, max. 25 W



- 78240107 | Nickel matt · nickel mat
- 78240108 | Messing matt · brass mat
- 78240131 | Weiß matt · white mat
- 78240132 | Schwarz matt · black mat



# PAROS

Metall · metal · metale · metaal · metal · metallo · metal · metalli · metal

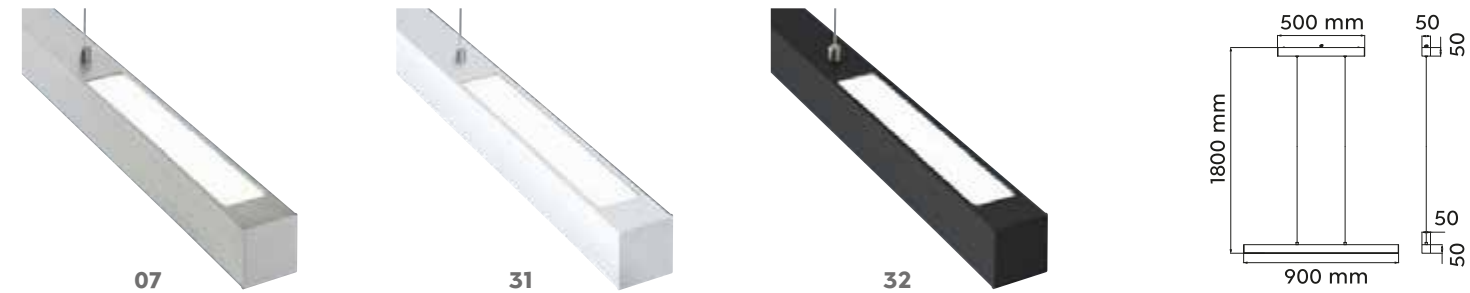

**PENDELLEUCHTE · PENDANT**  
incl. SMD-LED, 29 W  
3.400 lm, 3.000 K



- 73043107 | Nickel matt · nickel mat
- 73043131 | Weiß matt · white mat
- 73043132 | Schwarz matt · black mat



**PENDELLEUCHTE · PENDANT**  
excl. 1 x GU10, max. 25 W



- 73240107 | Nickel matt · nickel mat
- 73240108 | Messing matt · brass mat
- 73240131 | Weiß matt · white mat
- 73240132 | Schwarz matt · black mat



# ANTIBES

Metall, Glas Weiß · metal, glass white · metale, verre blanc · metaal, glas wit · metal, vidrio blanco · metallo, vetro bianco · metal, sticla alb · metalli, lasi valkoinen · metal, szkło biały

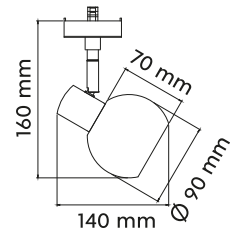

STRAHLER · SPOT  
excl. 1 x GU10, max. 25 W



78170107 | Nickel matt · nickel mat

# ONTARIO

Glas Weiß · glass white · verre blanc · glas wit · vidrio blanco · vetro bianco · sticla alb · lasi valkoinen · szkło biały

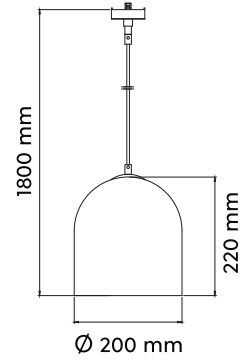

PENDELLEUCHTE · PENDANT  
excl. 1 x E14, max. 25 W



73520101 | weiß · white

# DIALLO

Metall · metal · metale · metaal · metal · metallo · metal · metalli · metal



07



31



32

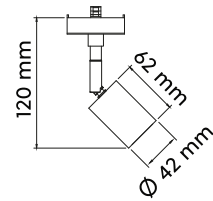

STRAHLER · SPOT  
excl. 1 x E27, max. 25 W



78010107 | Nickel matt · nickel mat

78010131 | Weiß matt · white mat

78010132 | Schwarz matt · black mat

# TOSH

Metall, Holz · metal, wood · metale, bois · metaal, hout · metal, madera · metallo, di legno · metal, lemn · metalli, puu · metal, drewno

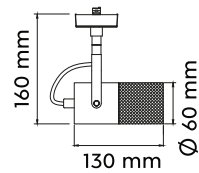

STRAHLER · SPOT  
excl. 1 x E14, max. 25 W



78430132 | Schwarz matt · black mat

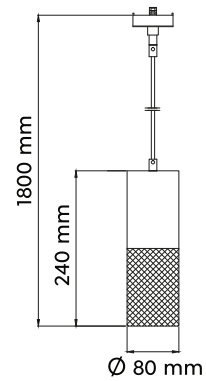

PENDELLEUCHTE · PENDANT  
excl. 1 x E27, max. 25 W



73430132 | Schwarz matt · black mat





# PANEL

Kunststoff · plastic · plastique · kunststof · plástico · plastica · plastic · muovi · plastik

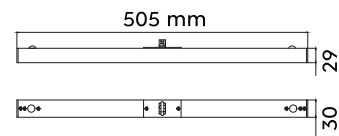

LED-PANEL  
incl. SMD-LED, 6 W  
850 lm, 3.000 K

- 77020131 | Weiß matt · white mat
- 77020132 | Schwarz matt · black mat
- 77020187 | titanfarbig · titan



# CAMILLUS

Kunststoff · plastic · plastique · kunststof · plástico · plastica · plastic · muovi · plastik

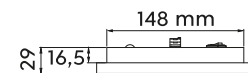

LED-PANEL  
incl. SMD-LED, 9 W  
900 lm, 3.000 K

- 76921031 | Weiß matt · white mat
- 76921032 | Schwarz matt · black mat
- 76921087 | titanfarbig · titan

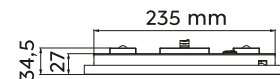

LED-PANEL  
incl. SMD-LED, 13 W  
1.400 lm, 3.000 K

- 76921531 | Weiß matt · white mat
- 76921532 | Schwarz matt · black mat
- 76921587 | titanfarbig · titan





# HOTEL

Stoffschild · fabric shade · abat-jour tissu · Stoffen kap · Pantalla de tela · paralume in tessuto · abajur textil · kangas varjostin · Klosz z materiału



01



11

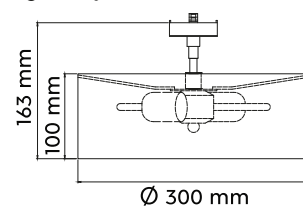

DECKENLEUCHTE · CEILING LAMP  
excl. 2 x E27, max. 25 W

76390201 | Weiß · white  
76390211 | Grau · grey



01



11

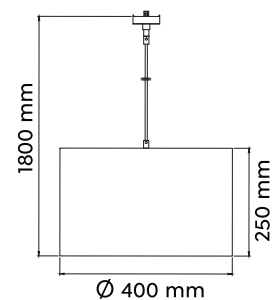

PENDELLEUCHTE · PENDANT  
excl. 1 x E27, max. 25 W

73330101 | Weiß · white  
73330111 | Grau · grey



# TOMMY

Stoffschild · fabric shade · abat-jour tissu · Stoffen kap · Pantalla de tela · paralume in tessuto · abajur textil · kangas varjostin · Klosz z materiału



01



11



79

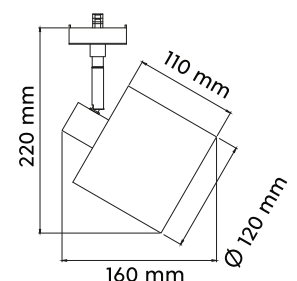

STRAHLER · SPOT  
excl. 1 x E14, max. 25 W

78330101 | Weiß · white  
78330111 | Grau · grey  
78330179 | goldfarbig · gold



# JIMMY

Metall, Schwarz · metal, black · metale, noir · metaal, zwart · metal, negro · metallo, nero · metal, negro · metalli, musta · metal, czarny



PENDELLEUCHTE · PENDANT  
excl. 1 x E27, max. 25 W



73120102 | Schwarz-Gold · black-gold

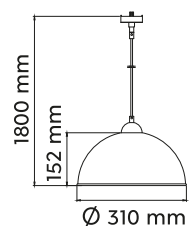

# HOSTEL

Stoffschild · fabric shade · abat-jour tissu · Stoffen kap · Pantalla de tela · paralume in tessuto · abajur textil · kangas varjostin · Klosz z materiału

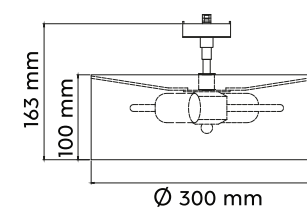

DECKENLEUCHTE · CEILING LAMP  
excl. 2 x E27, max. 25 W

76820280 | Schwarz-Gold · black-gold



PENDELLEUCHTE · PENDANT  
excl. 1 x E27, max. 25 W



73820180 | Schwarz-Gold · black-gold

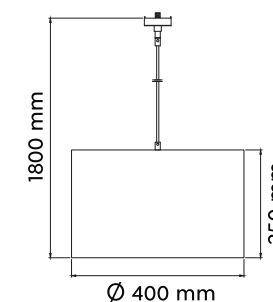





## Einbauleuchten

- Recessed lights
- Spots encastrés
- Inbouwspots
- Focos empotrables
- Faretti incasso
- Spoturi incastrate
- Upotetut spotit
- Oprawy wbudowane



# AURA

Kunststoff, Chrom, Weiß matt oder Schwarz matt · plastic, chrome, white mat or black mat ·  
 plastique, chrome, blanc mat ou noir mat · kunststof, chroom, wit mat of mat zwart · plástico, cromo, estera blanca o estera negra ·  
 plastica, cromo, bianco opaco o nero opaco · plastic, crom, alb mat sau negru mat · muovi, kromi, mattavalkoinen tai mattamusta ·  
 plastik, chrom, biały mat lub czarny mat



06

31

32

Einbauleuchte · Recessed light  
 Ø 8,2 cm, ↓ 4 cm  
 incl. 1 x SMD, 5 W  
 450 lm, 3.000 K

652310106 | Chrom · chrome  
 652310131 | Weiß matt · white mat  
 652310132 | Schwarz matt · black mat

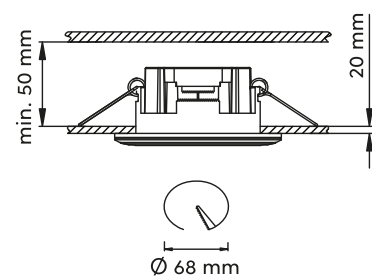

06

31

32

Einbauleuchte · Recessed light  
 Ø 14,8 cm, ↓ 3,8 cm  
 incl. 1 x SMD, 10 W  
 1.040 lm, 3.000 K

652410106 | Chrom · chrome  
 652410131 | Weiß matt · white mat  
 652410132 | Schwarz matt · black mat

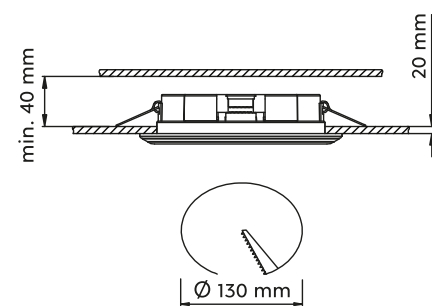

1x

2x

3x



Getrennt schaltbar · Separately switchable  
 Interrupteurs séparés · Gescheiden schakelbaar ·  
 Interruptores separados · Interruttori separati ·  
 Intrerupatoare separate · Erikseen kytkettävissä ·  
 Oddzileny przełącznik





# CORE

Kunststoff, Chrom, Weiß matt oder Schwarz matt · plastic, chrome, white mat or black mat ·  
 plastique, chrome, blanc mat ou noir mat · kunststof, chroom, wit mat of mat zwart · plástico, cromo, estera blanca o estera negra ·  
 plastica, cromo, bianco opaco o nero opaco · plastic, crom, alb mat sau negru mat · muovi, kromi, mattavalkoinen tai mattamusta ·  
 plastik, chrom, biały mat lub czarny mat



06

31

32

Einbauleuchte · Recessed light  
 Ø 8,2 cm, ↑ 3,5 cm  
 incl. 1 x SMD, 5 W  
 450 lm, 3.000 K

652510106 | Chrom · chrome  
 652510131 | Weiß matt · white mat  
 652510132 | Schwarz matt · black mat

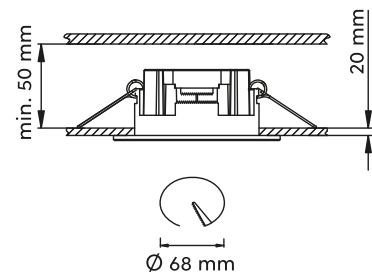

06

31

32

Einbauleuchte · Recessed light  
 Ø 14,8 cm, ↑ 3,3 cm  
 incl. 1 x SMD, 10 W  
 1.040 lm, 3.000 K

652610106 | Chrom · chrome  
 652610131 | Weiß matt · white mat  
 652610132 | Schwarz matt · black mat

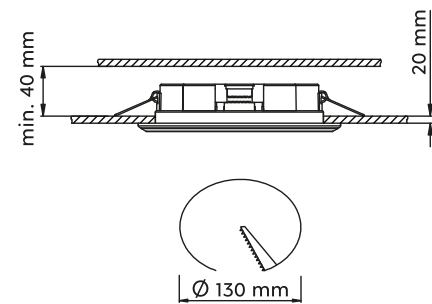

1x

2x

3x



Getrennt schaltbar · Separately switchable  
 Interrupteurs séparés · Gescheiden schakelbaar ·  
 Interruptores separados · Interruttori separati ·  
 Intrerupatoare separate · Erikseen kytkettävissä ·  
 Oddzileny przełącznik





# PAMIR

Metall · metal ·  
metale · metaal · metal · metallo · metal · metalli · metal ·



Dimmbar ·  
Dimmable



06



07



31



32

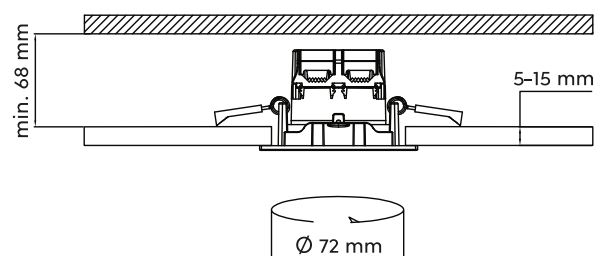

Ø 72 mm

560 Einbauleuchte · Recessed light  
↔ 8,5 x 8,5 cm, † 5,4 cm  
incl. 1 x SMD, 5,5 W  
345 lm, 3.000 K

650410106 | Chrom · chrome  
650410107 | Nickel matt · nickel mat  
650410131 | Weiß matt · white mat  
650410132 | Schwarz matt · black mat



IP23



06



07



31



32

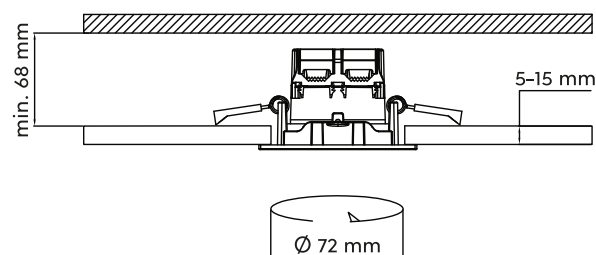

Ø 72 mm

Einbauleuchte · Recessed light  
Ø 8,5 cm, † 5,4 cm  
incl. 1 x SMD, 5,5 W  
345 lm, 3.000 K

650510106 | Chrom · chrome  
650510107 | Nickel matt · nickel mat  
650510131 | Weiß matt · white mat  
650510132 | Schwarz matt · black mat



IP23



561



# ZAGROS

Metall · metal ·  
metale · metaal · metal · metallo · metal · metalli · metal ·



06

07

31

32

Einbauleuchte · Recessed light  
↔ 8,5 x 8,5 cm, ↑ 5,4 cm  
incl. 1 x SMD, 5,5 W  
345 lm, 3.000 K

650610106 | Chrom · chrome  
650610107 | Nickel matt · nickel mat  
650610131 | Weiß matt · white mat  
650610132 | Schwarz matt · black mat

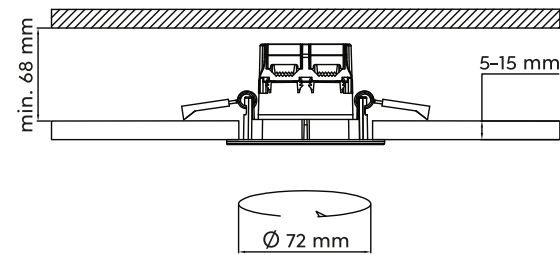

06

07

31

32

Einbauleuchte · Recessed light  
Ø 8,5 cm, ↑ 5,4 cm  
incl. 1 x SMD, 5,5 W  
345 lm, 3.000 K

650710106 | Chrom · chrome  
650710107 | Nickel matt · nickel mat  
650710131 | Weiß matt · white mat  
650710132 | Schwarz matt · black mat

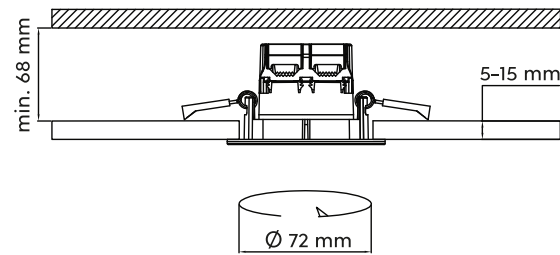

07



06

## 3er Set / Set 3

650610306 | Chrom · chrome  
650610307 | Nickel matt · nickel mat  
650610331 | Weiß matt · white mat

## 3er Set / Set 3

650710306 | Chrom · chrome  
650710307 | Nickel matt · nickel mat  
650710331 | Weiß matt · white mat

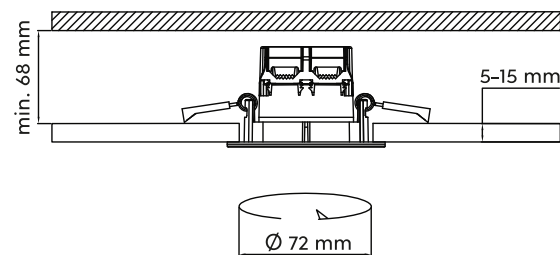



# RILA

Metall · metal ·  
metale · metaal · metal · metallo · metal · metalli · metal ·



Schwenkbar ·  
Tilttable



06

07

31

Einbauleuchte · Recessed light  
↔ 8 x 8 cm, ↑ 3,4 cm  
incl. 1 x SMD, 5 W  
450 lm, 3.000 K

650210106 | Chrom · chrome  
650210107 | Nickel matt · nickel mat  
650210131 | Weiß matt · white mat

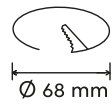
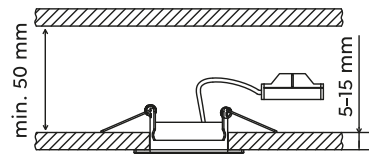

06

07

31

Einbauleuchte · Recessed light  
Ø 8,2 cm, ↑ 3,4 cm  
incl. 1 x SMD, 5 W  
450 lm, 3.000 K

650310106 | Chrom · chrome  
650310107 | Nickel matt · nickel mat  
650310131 | Weiß matt · white mat

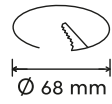
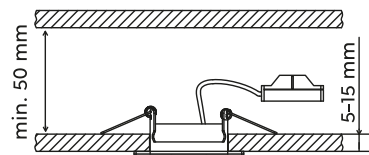

07



31

## 3er Set / Set 3

650210306 | Chrom · chrome  
650210307 | Nickel matt · nickel mat  
650210331 | Weiß matt · white mat

## 3er Set / Set 3

650310306 | Chrom · chrome  
650310307 | Nickel matt · nickel mat  
650310331 | Weiß matt · white mat

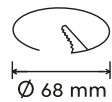
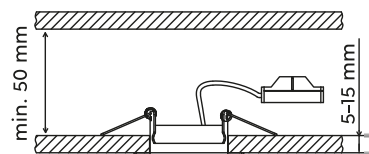



# DOLOMITE

Kristallglas · crystal glass ·  
verre cristal · kristal glas · vidrio cristal ·  
vetro cristallo · sticla cristal · kristallilasi · szkło kryształ



Einbauleuchte · Recessed light  
Ø 9 cm, ↓ 9,5 cm  
excl. 1 x GU10, max. 10 W



651700152

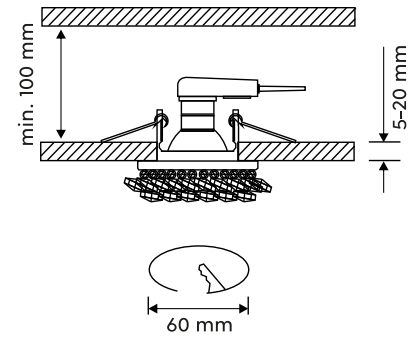

Einbauleuchte · Recessed light  
↔ 10 x 10 cm, ↓ 9,5 cm  
excl. 1 x GU10, max. 10 W



651800152

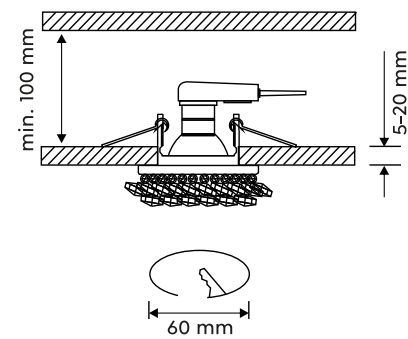

# PIRIN

Kristallglas · crystal glass ·  
verre cristal · kristal glas · vidrio cristal ·  
vetro cristallo · sticla cristal · kristallilasi · szkło kryształ



Einbauleuchte · Recessed light  
Ø 9 cm, ↓ 7 cm  
excl. 1 x GU10, max. 10 W



652100152

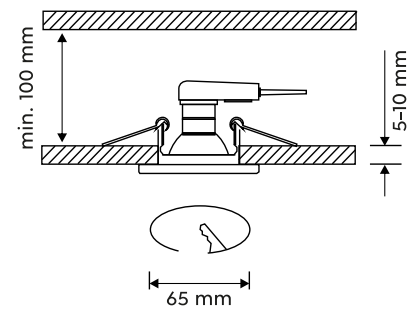

Einbauleuchte · Recessed light  
↔ 9 x 9 cm, ↓ 7 cm  
excl. 1 x GU10, max. 10 W



652200152

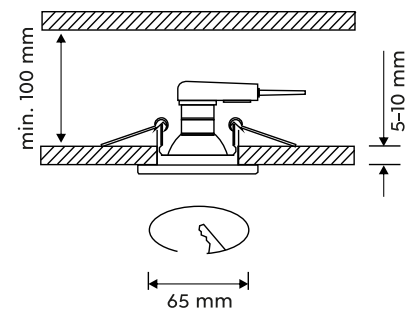

Empfohlen:  
recommended: LED GU10, 3 W  
250 lm, 3.000 K



956-30

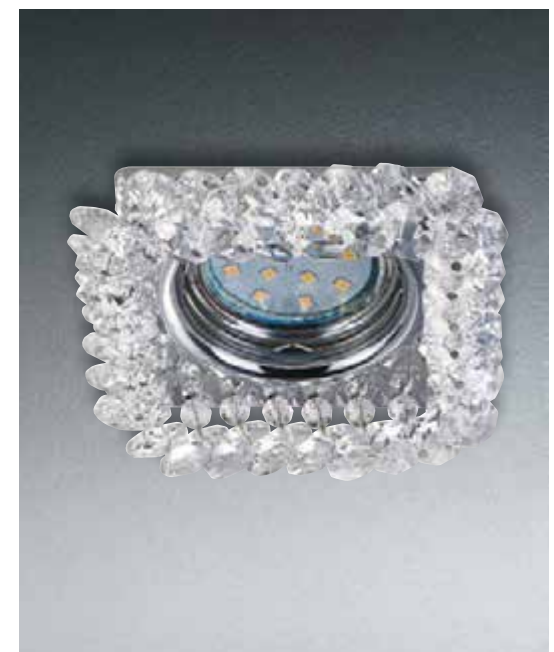



# JURA

Metall · metal ·  
metale · metaal · metal · metallo · metal · metalli · metal ·



Schwenkbar ·  
Tilttable



06

07

08

31

32

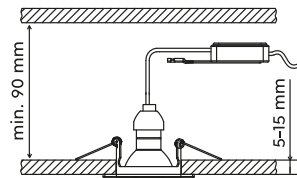

Einbauleuchte · Recessed light  
↔ 8 x 8 cm, ↓ 7 cm  
excl. 1 x GU10, max. 15 W

- 650000106 | Chrom · chrome
- 650000107 | Nickel matt · nickel mat
- 650000108 | Messing matt · brass mat
- 650000131 | Weiß matt · white mat
- 650000132 | Schwarz matt · black mat



568



06

07

08

31

32

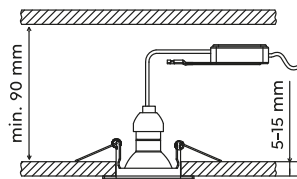

Einbauleuchte · Recessed light  
Ø 8,3 cm, ↓ 7 cm  
excl. 1 x GU10, max. 15 W

- 650100106 | Chrom · chrome
- 650100107 | Nickel matt · nickel mat
- 650100108 | Messing matt · brass mat
- 650100131 | Weiß matt · white mat
- 650100132 | Schwarz matt · black mat



569



31



07

## 3er Set / Set 3

- 650000306 | Chrom · chrome
- 650000307 | Nickel matt · nickel mat
- 650000331 | Weiß matt · white mat

## 3er Set / Set 3

- 650100306 | Chrom · chrome
- 650100307 | Nickel matt · nickel mat
- 650100331 | Weiß matt · white mat

Empfohlen:  
recommended: LED GU10, 3 W  
250 lm, 3.000 K



956-30





# KENAI

Metall · metal ·  
metale · metaal · metal · metallo · metal · metalli · metal ·



Schwenkbar ·  
Tilttable



31

32

Einbauleuchte · Recessed light  
Ø 9,2 cm, ↓ 10 cm  
excl. 1 x GU10, max. 15 W

651500131 | Weiß matt · white mat  
651500132 | Schwarz matt · black mat



Empfohlen:  
recommended: LED GU10, 4,5 W  
345 lm, 3.000 K



956-55

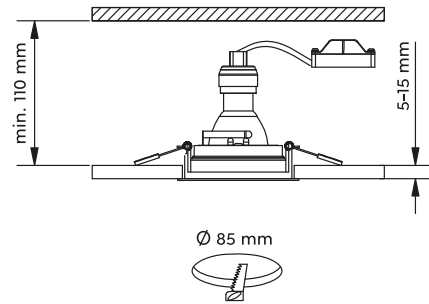

31

32

Einbauleuchte · Recessed light  
↔ 9,2 x 9,2 cm, ↓ 10 cm  
excl. 1 x GU10, max. 15 W

651600131 | Weiß matt · white mat  
651600132 | Schwarz matt · black mat

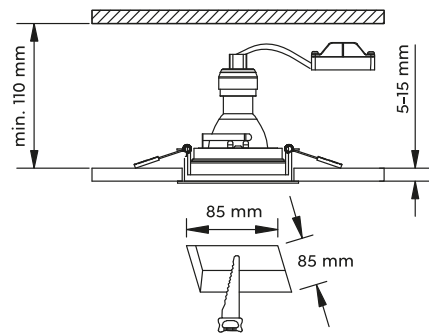

31

32

Einbauleuchte · Recessed light  
↔ 17,2 x 9,2 cm, ↓ 10 cm  
excl. 2 x GU10, max. 15 W

651600231 | Weiß matt · white mat  
651600232 | Schwarz matt · black mat

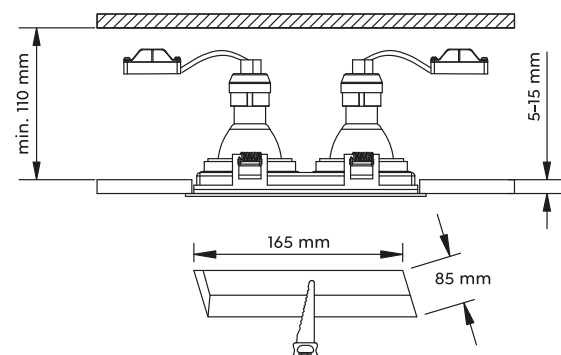

31

32

Einbauleuchte · Recessed light  
↔ 25,2 x 9,2 cm, ↓ 10 cm  
excl. 3 x GU10, max. 15 W

651600331 | Weiß matt · white mat  
651600332 | Schwarz matt · black mat

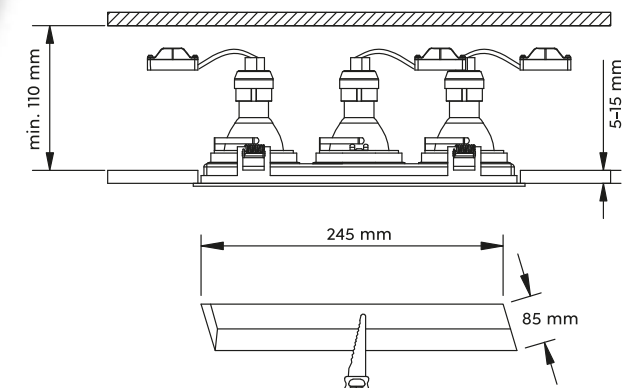



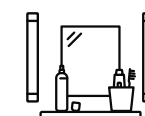

## Badezimmerleuchten

Bathroom lighting

Éclairage salle de bains

Badkamer verlichting

Iluminación de cuarto de baño

Illuminazione per bagno

Iluminat baie

Kylpyhuone valaistus

Oświetlenie łazienkowe



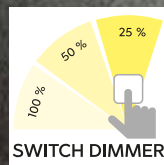

# ASCARI

Metall, Chrom oder Schwarz matt · metal, chrome or black mat ·  
metale, chrome ou noir mat · metaal, chroom of mat zwart · metal, cromo o estera negra ·  
metallo, cromo o nero opaco · metal, crom sau negru mat · metalli, kromi tai mattamusta ·  
metal, chrom lub czarny mat

IP44



Deckenleuchte · Ceiling lamp  
Ø 30 cm, ↑ 6,8 cm  
incl. SMD-LED, 28 W  
3.200 lm, 3.000 K



680810306  
680810332



Deckenleuchte · Ceiling lamp  
Ø 40 cm, ↑ 6,8 cm  
incl. SMD-LED, 35 W  
4.100 lm, 3.000 K



680819306  
680819332



06 | Chrom · chrome



32 | Schwarz matt · black mat



# GIANNI

Metall, Chrom oder Schwarz matt · metal, chrome or black mat ·  
metale, chrome ou noir mat · metaal, chroom of mat zwart · metal, cromo o estera negra ·  
metallo, cromo o nero opaco · metal, crom sau negru mat · metalli, kromi tai mattamusta ·  
metal, chrom lub czarny mat

IP44



06 | Chrom · chrome



32 | Schwarz matt · black mat



Wandleuchte · Wall lamp  
↔ 40 x 17,5 cm, ↗ 14,8 cm  
incl. SMD-LED, 17 W  
1.700 lm, 3.000 K



283770106  
283770132



Wandleuchte · Wall lamp  
↔ 60 x 8 cm, ↗ 15 cm  
incl. SMD-LED, 22 W  
2.700 lm, 3.000 K



283779106  
283779132







Deckenleuchte · Ceiling lamp  
 Ø 41,5 cm, ↑ 16,5 cm  
 incl. 5 x SMD-LED, 3,1 W  
 5 x 310 lm, 3.000 K



682410506

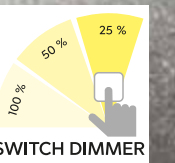

# BOLSA

Chrom, Acryl · chrome, acryl ·  
 chrome, acryl · chroom, acryl · cromo, acrílico ·  
 cromo, acrílico · crom, acrilic · kromi, akryyli ·  
 chrom, akryl



282410106



Wandleuchte · Wall lamp  
 ↑ 19 cm, ↔ 7 cm, ∠ 12 cm  
 incl. 1 x SMD-LED, 3,1 W  
 310 lm, 3.000 K



282410106



Wandleuchte · Wall lamp  
 ↑ 30 cm, ↔ 7 cm, ∠ 12 cm  
 incl. 2 x SMD-LED, 3,1 W  
 2 x 310 lm, 3.000 K



282410206



# CINZIA

Chrom, Acryl mit Kristalleffekt · chrome, broken glass optic ·  
 chrome, optique verre pilé · chroom, Gebroken glas optiek ·  
 cromo, Efecto cristal roto · cromo, effetto ottico vetro rotto ·  
 crom, aspect de sticla sparta · kromi, lasi efekti optiikka ·  
 chrom, Optyczne rozbite szkło

IP44



Deckenleuchte · Ceiling lamp  
 Ø 40 cm, ↑ 3 cm  
 incl. SMD-LED, 22 W  
 2.700 lm, 3.000 K



686412406



Deckenleuchte · Ceiling lamp  
 ↔ 40 x 40 cm, ↑ 3 cm  
 incl. SMD-LED, 22 W  
 2.700 lm, 3.000 K



686512406







# CLARIMO

Kunststoff · plastic ·  
 plastique · kunststof · plástico · plastica · plastic · muovi · plastik

IP44

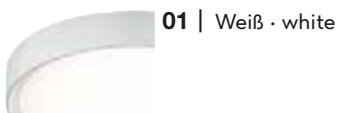

01 | Weiß · white



06 | Chrom · chrome

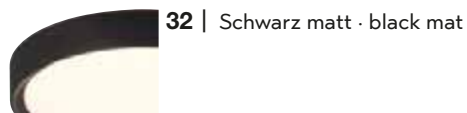

32 | Schwarz matt · black mat

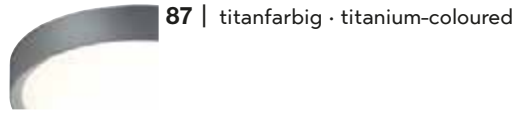

87 | titanfarbig · titanium-coloured

Deckenleuchte · Ceiling lamp  
 Ø 33 cm, ↓ 9 cm,  
 incl. SMD-LED, 18 W  
 1.850 lm, 3.000 K

IP44

659011801  
 659011806  
 659011832  
 659011887



# RAY

Kunststoff, Chrom oder Schwarz matt · plastic, chrome or black mat ·  
 plastique, chrome ou noir mat · kunststof, chrom of mat zwart ·  
 plástico, cromo o estera negra · plastica, cromo o nero opaco ·  
 plastic, crom sau negru mat · muovi, kromi tai mattamusta ·  
 plastik, chrom lub czarny mat

IP44

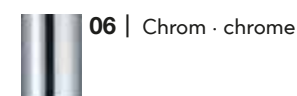

06 | Chrom · chrome

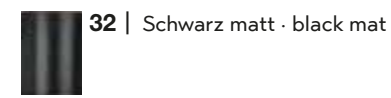

32 | Schwarz matt · black mat



Wandleuchte · Wall lamp  
 ↓ 8,3 x 5,2 cm, ↗ 8 cm  
 incl. 1 x SMD-LED, 4 W  
 340 lm, 3.000 K

IP44

283110106  
 283110132



Wandleuchte · Wall lamp  
 ↓ 16,6 x 5,2 cm, ↗ 8 cm  
 incl. 2 x SMD-LED, 4 W  
 2 x 340 lm, 3.000 K

IP44

283110206  
 283110232





# ROCCO

Metall, Chrom oder Schwarz matt · metal, chrome or black mat ·  
 metale, chrome ou noir mat · metaal, chroom of mat zwart · metal, cromo o estera negra ·  
 metallo, cromo o nero opaco · metal, crom sau negru mat · metalli, kromi tai mattamusta ·  
 metal, chrom lub czarny mat



IP44



06 | Chrom · chrome



32 | Schwarz matt · black mat

**Wandleuchte · Wall lamp**  
 ↔ 60 x 3,6 cm, ∅ 8 cm  
 incl. SMD-LED, 8 W  
 800 lm, 3.000 K



283916006  
 283916032

**Wandleuchte · Wall lamp**  
 ↔ 90 x 3,6 cm, ∅ 8 cm  
 incl. SMD-LED, 13 W  
 1.400 lm, 3.000 K



283919006  
 283919032





## FABIO

Metall, Chrom oder Schwarz matt · metal, chrome or black mat ·  
 metale, chrome ou noir mat · metaal, chroom of mat zwart · metal, cromo o estera negra ·  
 metallo, cromo o nero opaco · metal, crom sau negru mat · metalli, kromi tai mattamusta ·  
 metal, chrom lub czarny mat



IP44



01 | Weiß · white

02 | Schwarz · black



**Wandleuchte · Wall lamp**  
 ↔ 42,5 x 3,8 cm, ∅ 7,9 cm  
 incl. SMD-LED, 6 W  
 700 lm, 3.000 K



283814206  
 283814232



**Wandleuchte · Wall lamp**  
 ↔ 80 x 3,8 cm, ∅ 7,9 cm  
 incl. SMD-LED, 12 W  
 1.400 lm, 3.000 K



283817906  
 283817932



**Wandleuchte · Wall lamp**  
 ↔ 120 x 3,8 cm, ∅ 7,9 cm  
 incl. SMD-LED, 20 W  
 2.300 lm, 3.000 K



283811206  
 283811232







**Wandleuchte · Wall lamp**  
 ↔ 41,5 x 5,5 cm, ∅ 7 cm  
 incl. SMD-LED, 8 W  
 850 lm, 3.000 K



284074206  
 284074232



**Wandleuchte · Wall lamp**  
 ↔ 79 x 5,5 cm, ∅ 7 cm  
 incl. SMD-LED, 16 W  
 1.650 lm, 3.000 K



284077906  
 284077932



**Wandleuchte · Wall lamp**  
 ↔ 119 x 5,5 cm, ∅ 7 cm  
 incl. SMD-LED, 21 W  
 2.200 lm, 3.000 K



284071206  
 284071232

# PIERA

Kunststoff, Chrom oder Schwarz matt · plastic, chrome or black mat ·  
 plastique, chrome ou noir mat · kunststof, chroom of mat zwart · plástico, cromo o estera negra ·  
 plastica, cromo o nero opaco · plastic, crom sau negru mat · muovi, kromi tai mattamusta ·  
 plastik, chrom lub czarny mat

**IP44**



**06** | Chrom · chrome



**32** | Schwarz matt · black mat

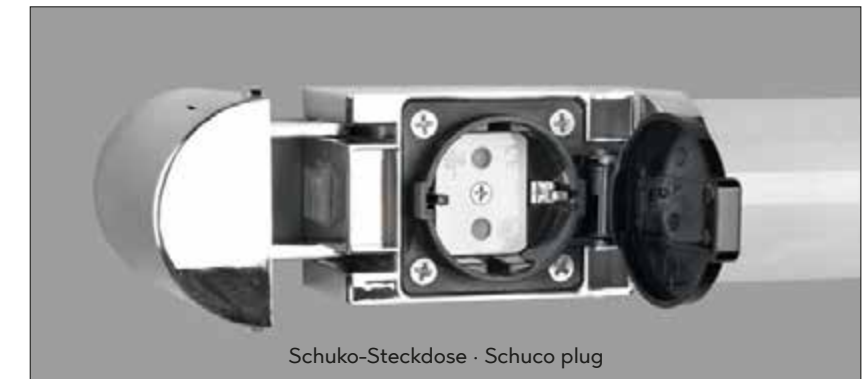

Schuko-Steckdose · Schuco plug







# KOLIAN

Kunststoff, Chrom · plastic, chrome ·  
plastique, chrome · kunststof, chroom · plástico, cromo · plastica, cromo · plastic, crom · muovi, kromi · plastik, chrom



IP44 Steckdose · Plug



Wandleuchte · Wall lamp  
↔ 44 x 6 cm, ∠ 9 cm  
incl. SMD-LED, 6 W  
700 lm, 3.000 K



281570606



Wandleuchte · Wall lamp  
↔ 64 x 6 cm, ∠ 9 cm  
incl. SMD-LED, 9 W  
970 lm, 3.000 K



281570906







**Wandleuchte · Wall lamp**  
↔ 40,4 x 5,5 cm, √ 8,5 cm  
incl. 1 x SMD-LED, 4,3 W  
450 lm, 3.000 K



283270106  
283270132



**Wandleuchte · Wall lamp**  
↔ 60,4 x 5,5 cm, √ 8,8 cm  
incl. 1 x SMD-LED, 6,5 W  
680 lm, 3.000 K



283270206  
283270232



**Wandleuchte · Wall lamp**  
↔ 80,4 x 5,5 cm, √ 8,8 cm  
incl. 1 x SMD-LED, 8,6 W  
880 lm, 3.000 K



283270306  
283270332

## MATTIMO

Metall, Kunststoff, Chrom oder Schwarz matt · metal, plastic, chrome or black mat ·  
metale, plastique, chrome ou noir mat · metaal, kunststof, chroom of mat zwart · metal, plástico, cromo o estera negra ·  
metallo, plastica, cromo o nero opaco · metal, plastic, crom sau negru mat · metalli, muovi, kromi tai mattamusta ·  
metal, plastik, chrom lub czarny mat

IP44



06 | Chrom · chrome



32 | Schwarz matt · black mat



H<sub>2</sub>O





## LINO

Kunststoff, Chrom oder Schwarz matt · plastic, chrome or black mat ·  
 plastique, chrome ou noir mat · kunststof, chrom of mat zwart · plástico, cromo o estera negra ·  
 plastica, cromo o nero opaco · plastic, crom sau negru mat · muovi, kromi tai mattamusta ·  
 plastik, chrom lub czarny mat



IP44

06 | Chrom · chrome

32 | Schwarz matt · black mat



Wandleuchte · Wall lamp  
 ↔ 40 x 6 cm, ∅ 10,5 cm  
 incl. SMD-LED, 7,4 W  
 900 lm, 3.000 K



284114006  
 284114032



Wandleuchte · Wall lamp  
 ↔ 60 x 6 cm, ∅ 10,5 cm  
 incl. SMD-LED, 11 W  
 1.350 lm, 3.000 K



284116006  
 284116032







## LORENZO

Metall, Chrom oder Schwarz matt · metal, chrome or black mat ·  
 metale, chrome ou noir mat · metaal, chroom of mat zwart · metal, cromo o estera negra ·  
 metallo, cromo o nero opaco · metal, crom sau negru mat · metalli, kromi tai mattamusta ·  
 metal, chrom lub czarny mat

IP44

Empfohlen:  
 recommended: LED GU10, 3 W  
 250 lm, 3.000 K



956-30



06 | Chrom · chrome



32 | Schwarz matt · black mat

Strahler · Spot  
 ↓ 5,4 x 3,3 cm, ↗ 10,1 cm  
 excl. 1 x GU10, max. 5 W



283500106  
 283500132



## GIADA

Metall, Chrom oder Schwarz matt · metal, chrome or black mat ·  
 metale, chrome ou noir mat · metaal, chroom of mat zwart · metal, cromo o estera negra ·  
 metallo, cromo o nero opaco · metal, crom sau negru mat · metalli, kromi tai mattamusta ·  
 metal, chrom lub czarny mat

IP44

Empfohlen:  
 recommended: LED GU10, 3 W  
 250 lm, 3.000 K



956-30



06 | Chrom · chrome



32 | Schwarz matt · black mat

Strahler · Spot  
 ↓ 11,4 x 5,4 cm, ↗ 34,3 cm  
 excl. 1 x GU10, max. 5 W



283400106  
 283400132

H<sub>2</sub>O





# ANGELO

Metall, Chrom oder Schwarz matt · metal, chrome or black mat ·  
 metale, chrome ou noir mat · metaal, chroom of mat zwart · metal, cromo o estera negra ·  
 metallo, cromo o nero opaco · metal, crom sau negru mat · metalli, kromi tai mattamusta · metal, chrom lub czarny mat



Strahler · Spot  
 Ø 10,5 cm, ↑ 15,5 cm  
 excl. 1 x GU10, max. 5 W

Strahler · Spot  
 Ø 20 cm, ↑ 15,5 cm  
 excl. 3 x GU10, max. 5 W

Strahler · Spot  
 ↔ 52 x 9,5 cm, ↑ 19,5 cm  
 excl. 4 x GU10, max. 5 W



880400106  
 880400132

880430306  
 880430332

880400406  
 880400432

IP44

Empfohlen:  
 recommended: LED GU10, 3 W  
 250 lm, 3.000 K



956-30



06 | Chrom · chrome



32 | Schwarz matt · black mat





# VIEW

Chrom · chrome · chrome · chroom · cromo · cromo · crom · kromi · chrom

IP44

On/Off Touch Funktion · On/Off Touch function

3x Vergrößerung 3x · Magnification 3x



Wandleuchte · Wall lamp  
Ø 21 cm, 2 max. 36 cm  
incl. SMD-LED, 3 W  
280 lm, 3.000 K



282990106



# THEATRO

Chrom · chrome · chrome · chroom · cromo · cromo · crom · kromi · chrom

IP44

Empfohlen:  
recommended: Filament LED E27, 4 W  
420 lm, 2.800 K



987-410



Wandleuchte · Wall lamp  
↔ 55 x 8 cm, 2 6,5 cm  
excl. 4 x E27, max. 28 W



283600406







# ZENIA

Metall · metal ·  
metale · metaal · metal · metallo · metal · metalli · metal

IP65

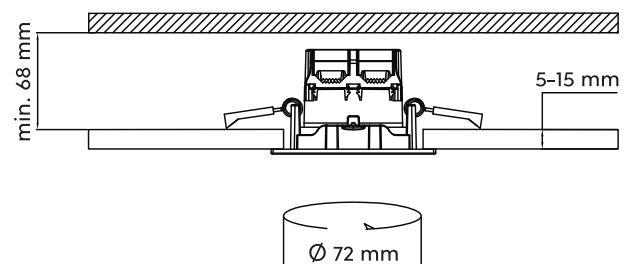

06 | Chrom · chrome



31 | Weiß matt · white mat



32 | Schwarz matt · black mat

Einbauleuchte · Recessed spot  
Ø 8,5 cm, ↓ 5,4 cm  
incl. SMD-LED, 5,5 W  
345 lm, 3.000 K



680710106  
680710131  
680710132



# CAMILLA

Kunststoff, Schwarz matt · plastic, black mat ·  
plastique, noir mat · kunststof, mat zwart · plástico, estera negra ·  
plastica, nero opaco · plastic, negru mat · muovi, mattamusta · plastik, czarny mat

IP44

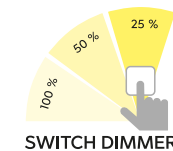

Deckenleuchte · Ceiling lamp  
Ø 40 cm, ↓ 3 cm  
incl. SMD-LED, 22 W  
2.700 lm, 3.000 K



689214032



Deckenleuchte · Ceiling lamp  
↔ 40 x 40 cm, ↓ 3 cm  
incl. SMD-LED, 22 W  
2.700 lm, 3.000 K



689314032







# PAOLO

Kunststoff, Weiß · plastic, white ·  
plastique, blanc · kunststof, wit · plástico, blanco ·  
plastica, bianco · plastic, alb · muovi, valkoinen · plastik, biały

IP44



Deckenleuchte · Ceiling lamp  
Ø 37 cm, ↑ 8,5 cm  
incl. SMD-LED, 15 W  
1.500 lm, 3.000 K



686014001



Deckenleuchte · Ceiling lamp  
Ø 37 cm, ↑ 8,5 cm  
incl. SMD-LED, 15 W  
1.500 lm, 4.000 K



686014000



# FRODENO

Acryl · acryl ·  
acryl · acryl · acrílico · acrilico · acrilic · akryyli · akryl

IP44



RGBW Farbwechsler ·  
RGBW Colorchanging



Memory Funktion ·  
Memory function



Starlight Effekt ·  
Starlight effect



Deckenleuchte · Ceiling lamp  
Ø 35 cm, ↑ 8,7 cm  
incl. RGBW-LED, 12 W  
1.200 lm, 4.000 K



680213500

Deckenleuchte · Ceiling lamp  
Ø 48 cm, ↑ 10,2 cm  
incl. RGBW-LED, 18,5 W  
1.900 lm, 4.000 K



680214800





## APART

Kunststoff, Chrom · plastic, chrome ·  
plastique, chrome · kunststof, chroom · plástico, cromo ·  
plastica, cromo · plastic, crom · muovi, kromi · plastik, chrom

IP44



Deckenleuchte · Ceiling lamp  
Ø 35 cm, ↓ 10 cm,  
incl. SMD-LED, 18 W  
1.850 lm, 3.000 K



659411806



Deckenleuchte · Ceiling lamp  
Ø 41 cm, ↓ 10 cm,  
incl. SMD-LED, 22 W  
2.500 lm, 3.000 K



659412406



## UMBERTO

Kunststoff, Chrom oder Schwarz matt · plastic, chrome or black mat ·  
plastique, chrome ou noir mat · kunststof, chroom of mat zwart · plástico, cromo o estera negra ·  
plastica, cromo o nero opaco · plastic, crom sau negru mat · muovi, kromi tai mattamusta ·  
plastik, chrom lub czarny mat

IP44



Deckenleuchte · Ceiling lamp  
Ø 29 cm, ↓ 8 cm  
incl. SMD-LED, 12 W  
1.160 lm, 3.000 K



680310106  
680310132



Deckenleuchte · Ceiling lamp  
Ø 42 cm, ↓ 10 cm  
incl. SMD-LED, 18,5 W  
1.900 lm, 3.000 K



680319106  
680319132



06 | Chrom · chrome



32 | Schwarz matt · black mat







## XAVI

Chrom, Glas matt · chrome, mat glass ·  
chrome, verre mat · chrom, mat glas · cromo, vidrio mate ·  
cromo, vetro sabbato · crom, sticla mata · kromi, mattalasi ·  
chrom, szkło matowane

IP21



Empfohlen:  
recommended: LED E14, 4,5 W  
470 lm, 2.700 K



989-400



Wandleuchte · Wall lamp  
↔ 30,5 cm, ↓ 8,3 cm, ↗ 6,3 cm  
excl. 2 x E14, max. 40 W



2803021-06



Wandleuchte · Wall lamp  
↔ 40,5 cm, ↓ 8,3 cm, ↗ 6,3 cm  
excl. 3 x E14, max. 40 W



2803031-06



## CONDUS

Metall, Glas matt · metal, mat glass ·  
metale, verre mat · metaal, mat glas ·  
metal, vidrio mate · metallo, vetro sabbato ·  
metal, sticla mata · metalli, mattalasi ·  
metal, szkło matowane

IP44

Empfohlen:  
recommended: LED E27, 4 W  
470 lm, 2.700 K



987-400



01 | Weiß · white



06 | Chrom · chrome



07 | Nickel matt · nickel mat

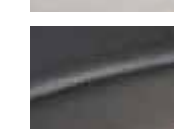

32 | Schwarz matt · black matt

Deckenleuchte · Ceiling lamp  
Ø 31,5 cm, ↓ 8 cm  
excl. 1 x E27, max. 60 W



6801011-01  
6801011-06  
6801011-07  
6801011-32

H<sub>2</sub>O





## Leuchtmittel

Light sources  
Ampoules  
Lichtbronnen  
Fuentes de luz  
Lampadine  
Becuri  
Valonlähteet  
Źródła światła



# LED-LEUCHTMITTEL E27

LED bulbs E27 · Ampoules LED E27 · LED-lampen E27 · Bombillas a LED E27 · Lampadine a LED E27 · Becuri cu LED-uri E27 · LED-Valonl hteet E27 ·  ar wki LED E27

Code	Socket	Power	Lumen	Kelvin	Lifetime	Dimmable	Switch Dimmer	Switch Dim To Warm
987-60	E27	4,9 W	470 lm	3.000 K	25.000 h			
988-700	E27	7 W	560 lm	3.000 K	25.000 h	✓		
988-10	E27	10 W	806 lm	3.000 K	25.000 h		✓	
988-110	E27	10 W	806 lm	3.000 K	25.000 h	✓		

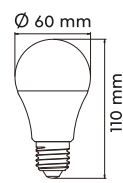

987-909	E27	9 W	806 lm	2.200 K 2.700 K 3.000 K	25.000 h			✓
---------	-----	-----	--------	-------------------------------	----------	--	--	---

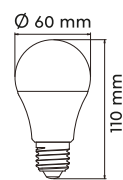

987-260	E27	4,9 W	470 lm	3.000 K	25.000 h			
---------	-----	-------	--------	---------	----------	--	--	--

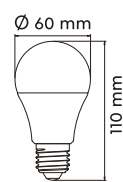
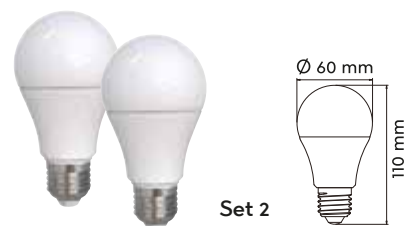

986-40	E27	4 W	320 lm	3.000 K	25.000 h			
986-60	E27	5 W	400 lm	3.000 K	25.000 h			

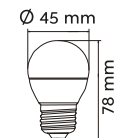
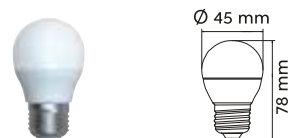

986-43	E27	4 W	320 lm	3.000 K	10.000 h			
986-63	E27	5 W	400 lm	3.000 K	10.000 h			

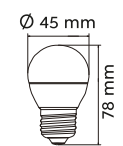

987-400	E27	4 W	470 lm	2.700 K	10.000 h			
987-6810	E27	7 W	806 lm	2.700 K	10.000 h		✓	

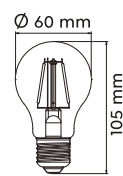
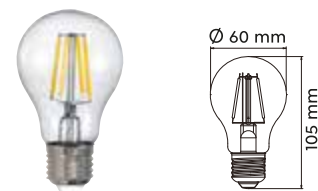

987-7009	E27	7 W	806 lm	2.200 K 2.700 K 3.000 K	10.000 h			✓
----------	-----	-----	--------	-------------------------------	----------	--	--	---

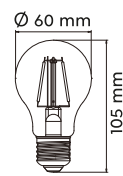
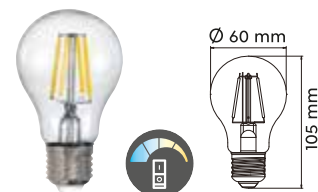

Code	Socket	Power	Lumen	Kelvin	Lifetime	Dimmable	Switch Dimmer	Switch Dim To Warm
987-2400	E27	4 W	470 lm	2.700 K	10.000 h			

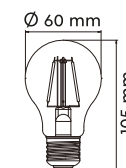

987-479 amber	E27	4 W	470 lm	2.700 K	10.000 h			
987-6700 amber	E27	8 W	700 lm	2.700 K	10.000 h		✓	

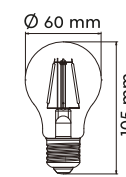
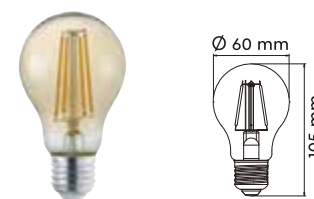

987-2479 amber	E27	4 W	470 lm	2.700 K	10.000 h			
----------------	-----	-----	--------	---------	----------	--	--	--

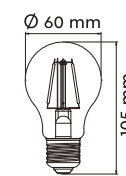
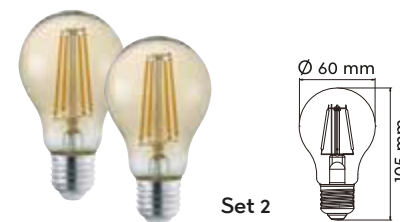

987-410 amber	E27	4 W	430 lm	2.800 K	10.000 h			
---------------	-----	-----	--------	---------	----------	--	--	--

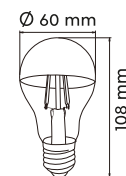
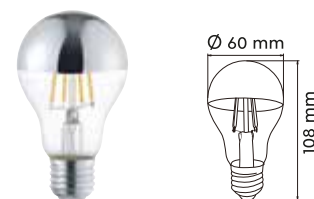

988-600	E27	7 W	806 lm	3.000 K	10.000 h			
---------	-----	-----	--------	---------	----------	--	--	--

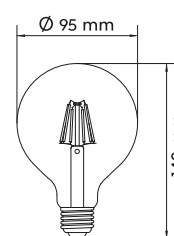

985-6810	E27	7 W	806 lm	2.700 K	10.000 h		✓	
----------	-----	-----	--------	---------	----------	--	---	--

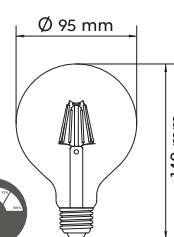



# LED-LEUCHTMITTEL E27

LED bulbs E27 · Ampoules LED E27 · LED-lampen E27 · Bombillas a LED E27 · Lampadine a LED E27 · Becuri cu LED-uri E27 · LED-Valonl hteet E27 ·  ar wki LED E27

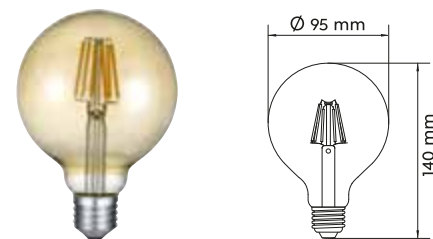

Code	Socket	Power	Lumen	Kelvin	Lifetime	Dimmable	Switch Dimmer	Switch Dim To Warm
------	--------	-------	-------	--------	----------	----------	---------------	--------------------

988-679	amber	E27	6 W	660 lm	2.700 K	10.000 h		
---------	-------	-----	-----	--------	---------	----------	--	--

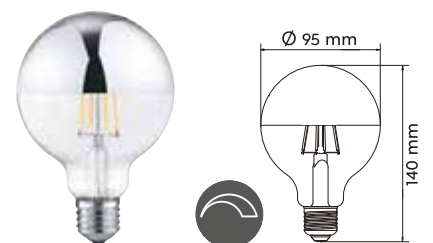

988-710		E27	7 W	680 lm	2.700 K	10.000 h	✓	
---------	--	-----	-----	--------	---------	----------	---	--



986-6810	clear	E27	8 W	810 lm	2.700 K	10.000 h		✓
986-6790	amber	E27	8 W	806 lm	2.700 K	10.000 h		✓



986-710		E27	7 W	680 lm	2.700 K	10.000 h	✓	
---------	--	-----	-----	--------	---------	----------	---	--



987-600	clear	E27	7 W	806 lm	3.000 K	10.000 h		
987-679	amber	E27	6 W	600 lm	2.700 K	10.000 h		

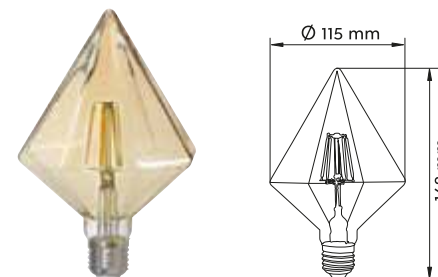

Code	Socket	Power	Lumen	Kelvin	Lifetime	Dimmable	Switch Dimmer	Switch Dim To Warm
------	--------	-------	-------	--------	----------	----------	---------------	--------------------

901-479	amber	E27	4 W	360 lm	2.700 K	25.000 h		
---------	-------	-----	-----	--------	---------	----------	--	--

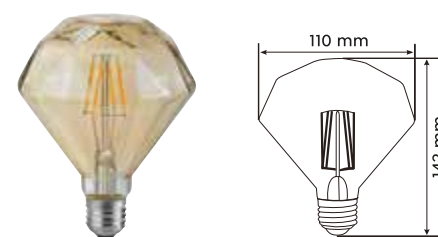

902-479	amber	E27	4 W	360 lm	2.700 K	25.000 h		
---------	-------	-----	-----	--------	---------	----------	--	--

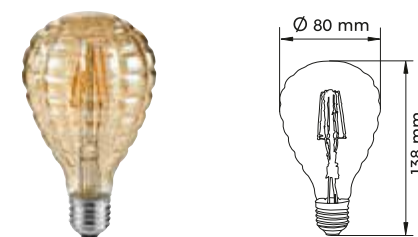

903-479	amber	E27	4 W	360 lm	2.700 K	25.000 h		
---------	-------	-----	-----	--------	---------	----------	--	--

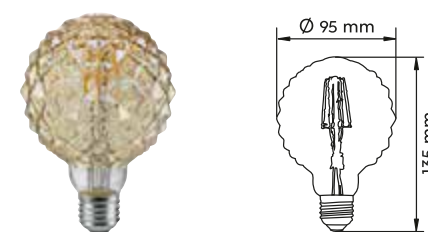

904-479	amber	E27	4 W	360 lm	2.700 K	25.000 h		
---------	-------	-----	-----	--------	---------	----------	--	--



# LED-LEUCHTMITTEL E14

LED bulbs E14 · Ampoules LED E14 · LED-lampen E14 · Bombillas a LED E14 · Lampadine a LED E14 · Becri cu LED-uri E14 · LED-Valonlähteet E14 · Żarówki LED E14

Code	Socket	Power	Lumen	Kelvin	Lifetime	Dimmable	Switch Dimmer	Switch Dim To Warm
989-40	E14	3,5 W	320 lm	3.000 K	25.000 h			
989-56	E14	5 W	400 lm	3.000 K	25.000 h	✓		
989-60	E14	5 W	400 lm	3.000 K	25.000 h			
989-66	E14	6 W	470 lm	3.000 K	25.000 h		✓	

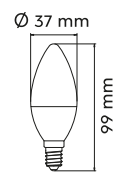
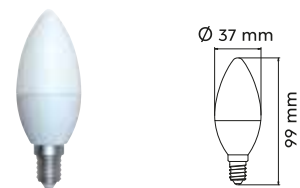

989-509	E14	5,5 W	400 lm	2.200 K 2.700 K 3.000 K	25.000 h			✓
---------	-----	-------	--------	-------------------------------	----------	--	--	---

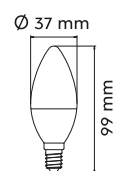
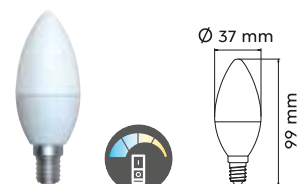

Set 3

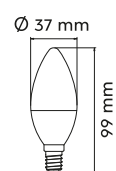

989-43	E14	4 W	320 lm	3.000 K	25.000 h			
989-63	E14	6 W	470 lm	3.000 K	25.000 h			

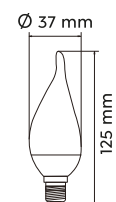

990-40	E14	4 W	320 lm	3.000 K	25.000 h			
--------	-----	-----	--------	---------	----------	--	--	--

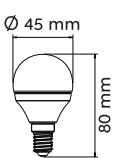
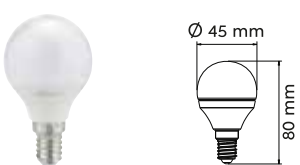

983-40	E14	3,5 W	320 lm	3.000 K	25.000 h			
983-56	E14	4,9 W	470 lm	3.000 K	25.000 h	✓		
983-60	E14	4,9 W	470 lm	3.000 K	25.000 h			
983-66	E14	4,9 W	470 lm	3.000 K	25.000 h		✓	

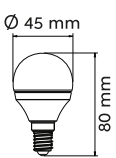
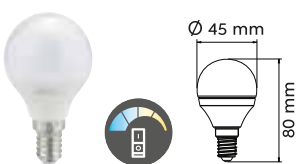

983-509	E14	5,5 W	400 lm	2.200 K 2.700 K 3.000 K	25.000 h			✓
---------	-----	-------	--------	-------------------------------	----------	--	--	---



Set 3

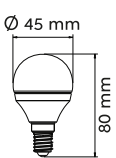

983-43	E14	3,5 W	320 lm	3.000 K	25.000 h			
983-63	E14	4,9 W	470 lm	3.000 K	25.000 h			

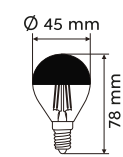

Code	Socket	Power	Lumen	Kelvin	Lifetime	Dimmable	Switch Dimmer	Switch Dim To Warm
983-410	E14	4 W	420 lm	3.000 K	10.000 h			

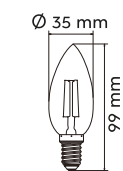

989-200	clear	E14	2 W	250 lm	2.700 K	10.000 h		
989-279	amber	E14	2 W	225 lm	2.700 K	10.000 h		
989-400	clear	E14	4 W	470 lm	2.700 K	10.000 h		
989-479	amber	E14	4 W	400 lm	2.700 K	10.000 h		

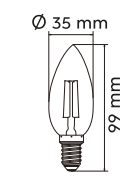

989-4470	clear	E14	4 W	470 lm	2.700 K	10.000 h		✓
989-4790	amber	E14	4 W	400 lm	2.700 K	10.000 h		✓

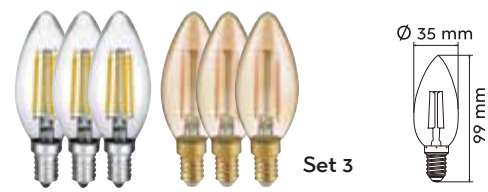

Set 3

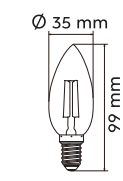

989-3200	clear	E14	2 W	250 lm	2.700 K	10.000 h		
989-3279	amber	E14	2 W	225 lm	2.700 K	10.000 h		
989-3400	clear	E14	4 W	470 lm	2.700 K	10.000 h		

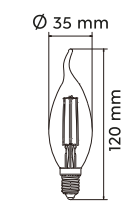

990-200	clear	E14	2 W	250 lm	2.700 K	10.000 h		
990-279	amber	E14	2 W	225 lm	2.700 K	10.000 h		
990-400	clear	E14	4 W	470 lm	3.000 K	10.000 h		

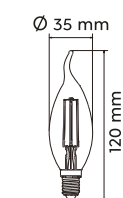

990-4470	clear	E14	4 W	470 lm	2.700 K	10.000 h		✓
990-4790	amber	E14	4 W	400 lm	2.700 K	10.000 h		✓

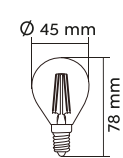

983-200	clear	E14	2 W	250 lm	2.700 K	10.000 h		
983-279	amber	E14	2 W	225 lm	2.700 K	10.000 h		
983-400	clear	E14	4 W	470 lm	2.700 K	10.000 h		
983-479	amber	E14	4 W	430 lm	2.700 K	10.000 h		



## LED-LEUCHTMITTEL E14

LED bulbs E14 · Ampoules LED E14 · LED-lampen E14 · Bombillas a LED E14 · Lampadine a LED E14 · Becuri cu LED-uri E14 · LED-Valonlähdeet E14 · Żarówki LED E14

Code	Socket	Power	Lumen	Kelvin	Lifetime	Dimmable	Switch Dimmer	Switch Dim To Warm
------	--------	-------	-------	--------	----------	----------	---------------	--------------------



983-4470	clear	E14	4,5 W	470 lm	2.700 K	10.000 h		✓
983-4790	amber	E14	4 W	400 lm	2.700 K	10.000 h		✓



983-3200	clear	E14	2 W	250 lm	2.700 K	10.000 h		
983-3279	amber	E14	2 W	225 lm	2.700 K	10.000 h		
983-3400	clear	E14	4 W	470 lm	2.700 K	10.000 h		



955-55	↘ 110°	E14	5 W	400 lm	3.000 K	25.000 h		
--------	--------	-----	-----	--------	---------	----------	--	--

## LED-LEUCHTMITTEL G9

LED bulbs G9 · Ampoules LED G9 · LED-lampen G9 · Bombillas a LED G9 · Lampadine a LED G9 · Becuri cu LED-uri G9 · LED-Valonlähdeet G9 · Żarówki LED G9

Code	Socket	Power	Lumen	Kelvin	Lifetime	Dimmable	Switch Dimmer	Switch Dim To Warm
------	--------	-------	-------	--------	----------	----------	---------------	--------------------



Set 2

929-220	G9	2,3 W	200 lm	3.000 K	25.000 h			
---------	----	-------	--------	---------	----------	--	--	--



Set 2

929-2300	G9	3 W	300 lm	3.000 K	25.000 h	✓		
----------	----	-----	--------	---------	----------	---	--	--



Set 2

929-230	G9	3 W	300 lm	3.000 K	25.000 h		✓	
---------	----	-----	--------	---------	----------	--	---	--

## LED-LEUCHTMITTEL GU10

LED bulbs GU10 · Ampoules LED GU10 · LED-lampen GU10 · Bombillas a LED GU10 · Lampadine a LED GU10 · Becuri cu LED-uri GU10 · LED-Valonlähdeet GU10 · Żarówki LED GU10

Code	Socket	Power	Lumen	Kelvin	Lifetime	Dimmable	Switch Dimmer	Switch Dim To Warm
------	--------	-------	-------	--------	----------	----------	---------------	--------------------



956-30	↘ 110°	GU10	3 W	250 lm	3.000 K	20.000 h		
--------	--------	------	-----	--------	---------	----------	--	--



Set 3

956-330	↘ 110°	GU10	3 W	250 lm	3.000 K	15.000 h		
---------	--------	------	-----	--------	---------	----------	--	--



955-50	↘ 110°	GU10	5 W	400 lm	3.000 K	25.000 h		
--------	--------	------	-----	--------	---------	----------	--	--



956-5936	↘ 36°	GU10	5 W	400 lm	3.000 K	20.000 h	✓	
----------	-------	------	-----	--------	---------	----------	---	--



956-5736	↘ 36°	GU10	4,5 W	345 lm	3.000 K	20.000 h		✓
----------	-------	------	-------	--------	---------	----------	--	---



956-55	↘ 110°	GU10	4,5 W	345 lm	3.000 K	25.000 h		✓
--------	--------	------	-------	--------	---------	----------	--	---



Set 3

956-355	↘ 110°	GU10	4,5 W	345 lm	3.000 K	25.000 h		✓
---------	--------	------	-------	--------	---------	----------	--	---



956-509	↘ 36°	GU10	5 W	345 lm	2.200 K	25.000 h		✓
				2.700 K				
				3.000 K				



# POS-LÖSUNGEN

POS solutions · Solutions de POS · POS-oplossingen ·  
Soluciones POS · Soluzioni POS · Soluții POS · POS-ratkaisut · Rozwiązania POS

Leuchtmittel · Light sources



Tego-Regale  
Tego shelves

↔ 1000 x 630 mm  
↓ 2420/2675 mm



Topper PT 0011 XX  
↔ 800 mm, ↓ 400 mm



Topper PT 0012 XX  
↔ 800 mm, ↓ 400 mm



Topper PT 0013 CC  
↔ 800 mm, ↓ 400 mm



Topper PT 0014 XX  
↔ 800 mm, ↓ 400 mm



Display RK51  
↔ 800 x 400 mm  
↓ 1300 mm

Topper  
↔ 800 mm, ↓ 400 mm



Display RK78  
↔ 800 x 400 mm  
↓ 1400 mm

Topper PT0013  
↔ 800 mm, ↓ 400 mm



Display PP005  
↔ 800 x 400 mm  
↓ 1300 mm

Topper PT0030  
↔ 600 mm, ↓ 350 mm



# POS-LÖSUNGEN

POS solutions · Solutions de POS · POS-oplossingen ·  
Soluciones POS · Soluzioni POS · Soluții POS · POS-ratkaisut · Rozwiązania POS



Individuell planbar ·  
individually plannable



Tego-Regale  
Tego shelves

↔ 1000/1250 mm  
↓ 2400/2600 mm



Display **DUO01**  
↔ 1200 x 800 mm  
↓ 2480 mm



## Badezimmerleuchten · Bathroom lighting



Tego-Regale  
Tego shelves

↔ 1000/1250 mm  
↓ 2420/2675 mm



Display **RK99**  
↔ 1200 x 800 mm  
↓ 2479 mm





# POS-LÖSUNGEN

POS solutions · Solutions de POS · POS-oplossingen ·  
Soluciones POS · Soluzioni POS · Soluții POS · POS-ratkaisut · Rozwiązania POS

Einbauleuchten · Recessed lights

622



Sticker  
POST1033

Sticker  
POST1034

Unterbauleuchten ·  
Cabinet lights

Tego-Regale  
Tego shelves

↔ 1000/1250 mm  
↓ 2420/2675 mm

623

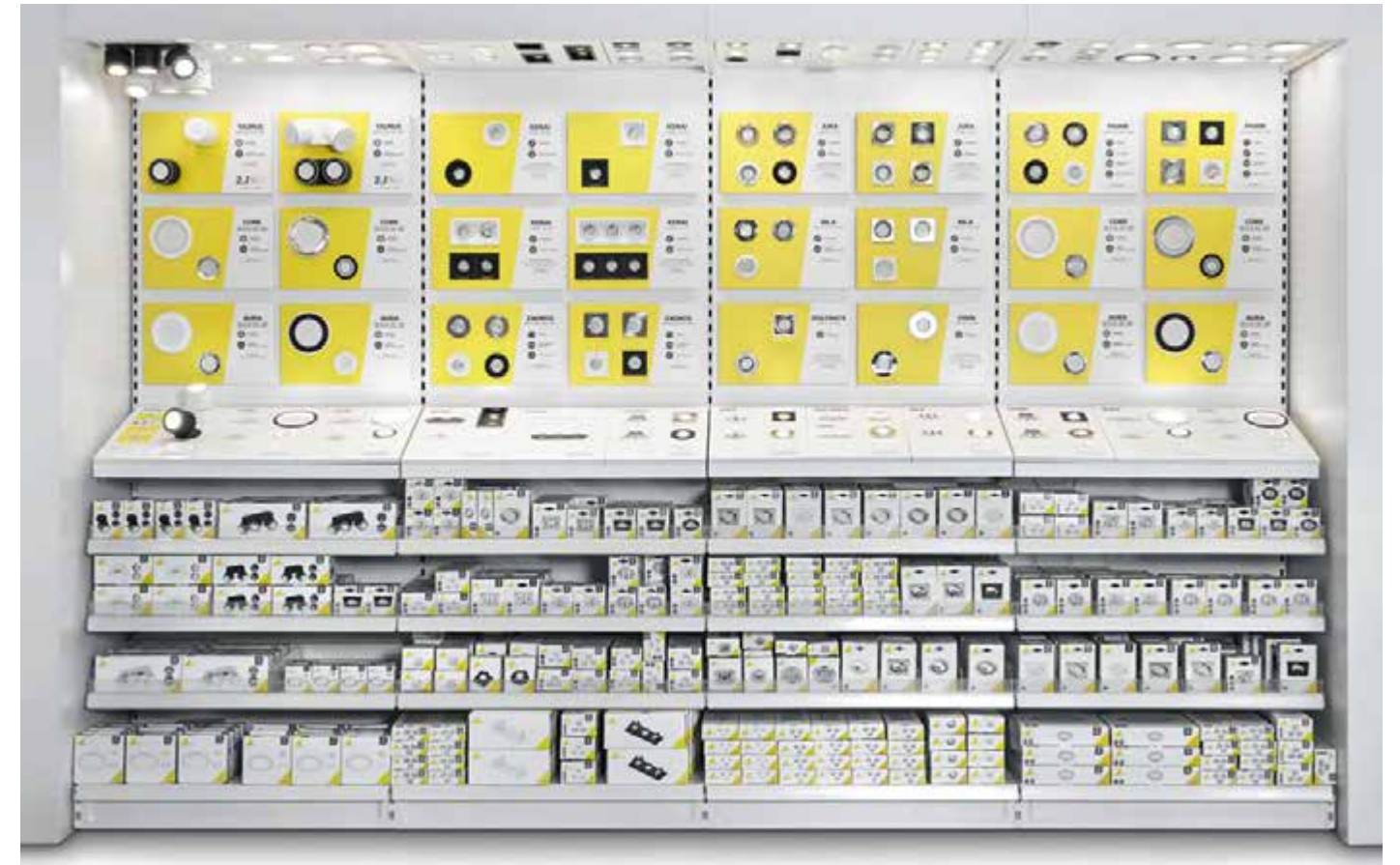

Tego-Regale  
Tego shelves

↔ 1000/1250 mm  
↓ 2400/2600 mm



Display **RK63**  
↔ 1200 x 800 mm  
↓ 2100 mm





## Spezifikationen

Specifications  
 Spécifications  
 Specificaties  
 Especificaciones  
 Specifiche  
 Specificații  
 Tekniset tiedot  
 Specyfikacje



# FARBEN & MATERIALIEN

Colours and materials · Couleurs et matériaux · Kleuren en materialen · Colores y materiales · Colori e materiali · Culori si materiale · Värit ja materiaalit · Kolory i materiały · Renkler ve malzemeler

- 00** Transparent · transparent  
transparent · transparant · transparente · transparente · transparent · kirkas · przezroczysty · şeffaf
- 01** Weiß · white  
blanc · wit · blanco · bianco · alb · valkoinen · biały · beyaz
- 02** Schwarz · black  
noir · zwart · negro · nero · negru · musta · czarny · siyah
- 03** Messing poliert · polished brass  
laiton polis · gepolijst messing · bronze · ottone lucido · bronz · messinki · mosiądz polerowany · piring
- 04** Altmessing · old brass  
laiton fumé · oud brons · bronze viejo · ottone invecchiato · bronz antic · antiikkimessinki · patyna · antik piring
- 05** Aluminium gebürstet · brushed aluminium  
aluminium balayé · geborsteld aluminium · aluminio pulido · alluminio spazzolato · aluminiu lucios · harjattu alumiini · aluminium szczotkowane · alüminyum
- 06** Chrom · chrome  
chrome · chroom · cromo · cromo · crom · kromi · chrom · krom
- 07** Nickel matt · nickel mat  
nickel mat · nikkel mat · níquel mate · nichel opaco · nichel mat · harjattu teräs · nikiel mat · mat nikel
- 08** Messing matt · brass mat  
laiton mat · messing mat · bronze mate · ottone satinato · bronz mat · mattamessinki · mosiądz mat · mat piring
- 09** kupferfarbig · copper  
cuivré · koperkleurig · color cobre · colore rame · cupru · kuperinvärinen · kolorze miedzi · bakir renkli
- 10** Rot · red  
rouge · rood · rojo · rosso · rosu · punainen · czerwony · kırmızı
- 11** Grau · grey  
gris · grijs · gris · grigio · gri · harmaa · popielaty · gri
- 12** Blau · blue  
bleu · blauw · azul · azzurro · gri · sininen · niebieski · mavi
- 13** Amber · amber  
ambre · amber · ámbar · ambra · amber · meripihka · bursztynowy · amber
- 14** Braun · brown  
brun · bruin · marron · marrone · maro · ruskea · brązowy · kahverengi
- 15** Grün · green  
vert · groen · verde · verde · verde · vihreä · zielony · yeşil
- 16** Gelb · yellow  
jaune · geel · amarillo · giallo · galben · keltainen · żółty · sarı

- 17** mehrfarbig · multicolor  
multicolore · multicolor · multicolor · multicolore · multicolor · monivärinen · multi-kolor · çok renkli
- 18** Orange · orange  
orange · oranje · naranja · arancione · portocaliu · oranssi · pomarańczowy · turuncu
- 19** Türkis · turquoise  
turquoise · turquoise · turquesa · turchese · turcoaz · turkoosi · turkusowy · turkuvaz
- 24** rostfarbig · rusty  
rouille · roestkleur · óxido · ruggine · ruginiu · rustiikki · miedź · pas
- 26** Braun · brown  
brun · bruin · marron · marrone · maro · ruskea · brązowy · kahverengi
- 27** Weiß antik · antique white  
blanc antique · antiek wit · blanco decapé · bianco anticato · alb antic · antiikkivalkoinen · antyczny biały · antik beyaz
- 28** rostfarbig antik · antique rust  
rouille antique · roestkleur antiek · oxido · ruggine anticato · ruginiu antic · rustiikki · antyczny rdzawy · antik pas rengi
- 29** Kupfer matt · copper mat  
cuivre mat · koper mat · estera de cobre · rame opaco · cupru mat · kupari mat · miedź mat · bakır mat
- 30** holzfarbig · wood coloured  
couleur bois · houtkleur · color madera · colore di legno · culoare lemn · puunvärinen · kolor drewna · ağşap renk
- 31** Weiß matt · white mat  
blanc mat · wit mat · estera blanca · bianco opaco · alb mat · valkoinen matto · biały mat · beyaz mat
- 32** Schwarz matt · black mat  
noir mat · mat zwart · estera negra · nero opaco · negru mat · musta matto · czarny mat · siyah mat
- 41** Taupe · taupe  
taupe · taupe · gris pardo · taupe · taupe · ruskeanharmaa · ciemnoszary · taupe
- 42** Anthrazit · anthracite  
antracite · antraciet · antracita · antracite · antracit · antrasiitti · antracyt · antrasit
- 45** Pastellblau · pastel blue ·  
bleu pastel · pastel blauw · azul pastel · azzurro pastello · albastru pastel · pastellinsininen · pastelowy niebieski · pastel mavi
- 51** Apfelgrün · applegreen  
vert pomme · appelgroen · verde manzana · verde mela · verde mar · omenanvihreä · zielone jabłko · elma yeşili
- 52** Transparent klar · transparent clear  
transparent claire · transparant helder · transparente claro · transparente chiaro · transparent clar · kirkas · przezroczysty · şeffaf

- 54** rauchfarbig · smoke  
fumé · rookkleur · humo · fume' · fumuriu · savu · przydymiony · duman
- 56** Holz dunkel · old wood  
vieux bois · oud hout · madera envejecida · legno antico · old wood (Lemn vechi) · vanha puu · stare drewno
- 61** Grau antik · antique grey  
gris ancien · antiek grijs · gris antiguo · grigio antico · antic gri · antiikki harmaa · starodawny szary · antika gri
- 62** Kupfer antik · antique copper  
cuivre ancien · antiek koper · cobre antiguo · rame antico · cupru antic · antiikki kupari · antyczne miedzi · antik bakır
- 64** Bronze · bronze  
bronze · bronze · bronze · bronzo · bronz · pronssi · brąz · tunç
- 67** Nickel antik · nickel antique  
nickel antique · antiek nikkel · níquel antiguo · nickel anticato · nichel antic · antiikkiteräs · aikiel antyczny · antik nikel
- 78** betonfarbig · concrete look  
couleur beton · beton kleur · color concreto · calcestruzzo · culoare beton · konkreettisia väri · konkretny kolor · beton rengi
- 79** goldfarbig · gold  
or · goud · oro · oro · aur · kultaa · złota · altın

- 80** Schwarz-Gold · black-gold  
noir et or · zwart-goud · negro-oro · oro nero · negru-auriu · musta-kulta · czarno złoty
- 87** titanfarbig · titan  
titane · titaan · titán · titano · titaniu · titaani · tytanowy · titan
- 88** Silber antik · antique silver  
argent antique · antiek zilver · plateado antiguo · argento anticato · argint antic · antiikkihopea · antyczne srebro · gümüş antika
- 89** silberfarbig · silver  
argent · zilver · plata · argento · argint · hopea · srebrny · gümüş
- 91** Lila · lilac  
lilla · lilla · lila · lilla · lila · lila · liliowy · leylak
- 92** Purpurrot · purple  
pourpre · paars · púrpura · porpora · purpuriu · purppura · purpurowy · mor
- 93** Pink · pink  
rose · pink · rosa · rosa · roz · pinkki · różowy · pembe
- 94** Pastellrosa · pastel pink ·  
rose pastel · pastel rose · rosa pastel · rosa pastello · roz pastel · pastellin pinkki · pastelowy róż · pastel pembe



# PRODUKTEIGENSCHAFTEN

Features · Caractéristiques · Kenmerken · Acabados · Caratteristiche · Caracteristici · Ominaisuudet · Cechy



Schalter · Switch  
Interrupteur · Schakelaar · Interruptor · Interruttore · Intrerupator · Kytkin · Przełącznik



Fußschalter · Footswitch  
interrupteur à pédale · Voetschakelaar · Interruptor de pie · interruttore a pedale · comutator picior · Päälle / pois jalkakytin · wyłącznik nożny



Schnurschalter · Cable switch  
Interrupteur de cordon · Snoerschakelaar · Cable de interruptor · Interruttore su cavo · Intrerupator cu cablu · katkaisin ja johto · Przełącznik na kablu



On/Off Touch Funktion · On/Off Touch function  
Interrupteur tactile On/Off · Touch schakelaar On/Off · Función táctil On/Off · Interruttore touch On/Off · Intrerupator tactil On/Off · Kosketuskäyttöinen On/Off · Funkcja dotykowa On/Off



Getrennt schaltbar · Separately switchable  
Interrupteurs séparés · Gescheiden schakelbaar · Interruptores separados · Interruttori separati · Intrerupatoare separate · Erikseen kytkettävissä · Oddzileny przełącznik



Fernbedienung · Remote control  
Commande à distance · Afstandsbediening · Mando a distancia · Comando a distanza · Telecomanda · Kauko-ohjain · Pilot



Integrierter Dimmer · Integrated dimmer  
Variateur intégré · Geïntegreerde dimmer · Regulador integrado · Dimmer integrato · Variator de lumina integrat · Integroitu himmennin · Wbudowany ściemniacz



Zugschalter · Pull switch  
Interrupteur de trait · Trekschakelaar · Interruptor de tiro · Interruttore con tirata · Interupator de tragere · Vetokytin · Przełącznik pociągany



Sensordimmer · Sensor dimmer  
Variateur tactile · Touchdimmer · Regulador con sensor · Touchdimmer · Variator cu senzor · Kosketushimmennin · Czujnik ściemniania



Extern dimmbar · Externally dimmable  
Dimmable avec variateur externe · Extern dimbaar · Dimmable por regulador externo · Dimmerabile con dimmer esterno · variator extern de lumina · himmennettävissä · Zewnętrznie ściemniana



RGB Farbwechsler · RGB Colorchanging  
Changement de couleur RGB · RGB Kleurverandering · Cambio de color RGB · Cambia colore RGB · Schimbator de culoare RGB · Värinvaihto RGB · Zmieniający kolor RGB



Lichtfarbe einstellbar · Adjustable light color  
Couleur de lumière réglable · Lichtkleur instelbaar · Color de luz regulable · Colore della luce regolabile · Lumina colorata reglabila · Värilämpötila säädettävissä · Regulowana barwa światła



Höhenverstellbar · Adjustable height  
Hauteur réglable · In hoogte verstelbaar · Altura regulable · Altezza regolabile · Inaltime reglabila · Säädettävä korkeus · Regulowana wysokość



Schwenkbar · Tilttable  
Pivotant · Draaibaar · Pivotante · Girevole · Pivotant · Suunnattava · Skråtøy



Steckdose · Plug  
Prise · Stekker · Enchufe · Spina · Priza · Katkaisin · Gniazdko



Vergrößerung 3x · Magnification 3x  
Magnification 3x · Vergroting 3x · Aumentos 3x · Ingrandimento 3x · Suplimentare 3x · Suurentava 3x · Powiększenie 3x



4 fach TOUCH · 4 level Touch function  
Interrupteur tactile 4 niveaux · Touch schakelaar 4 niveaux · Función Táctil 4 nivel · Interruttore touch 4 livelli · Intrerupator tactil 4 nivele · Kosketuskäyttöinen 4 taso · Funkcja dotykowa 4 poziomy



Flexibel · Flexible  
Flexible · Flexibel · Flexible · Flessibile · Flexibil · Joustava · Elastyczne



Kippbar · Tilttable  
Inclinable · Kantelbaar · Basculante · Inclinabile · Basculant · Kallistettava · Uchylny



Lichtfarbe stufenlos einstellbar · Light color infinitely variable  
Couleur de lumière infiniment variable · Lichtkleur traploos instelbaar · Color de luz infinitamente variable · Colore della luce infinitamente variabile · Culoare lumină infinit variabilă · Valon väri portaattomasti · Jasny kolor bezstopniowo



USB Anschluss · USB connection  
Entrée USB · USB aansluiting · Conexión USB · Connessione USB · Conexiune USB · USB-liitäntä · Połączenie USB



USB Anschluss mit Ladefunktion · Recharging USB connection  
Entrée USB de rechargement · Opladende USB aansluiting · Conexión USB de recarga · Connessione USB di ricarica · Conexiune USB reîncărcare · Lataaminen USB-liitäntä · ładowania USB połączenie



Nachtlicht · Night light  
Veilleuse de nuit · Nachtlicht · Luz de la noche · Luce notturna · Lampă de noapte · Yövalo · Lampka nocna



Gestensteuerung · Gesture control  
Contrôle gestuel · Gebarenbediening · Control gestual · Controllo gestuale · Control prin gesturi/mișcarea mâinii · Kädellä ohjattava liiketunnistin · Sterowana gestami



Up and down Beleuchtung · Up and Down lighting  
Point lumineux en haut et en bas · Lichtpunt boven en onder · Luz de arriba y abajo · Luce su e giù · Sus și în jos lumina · Ylös ja alas valoa · W górę iw dół światło



Dimmbar mit Schalter · Dimmable via switch  
Réglable avec interrupteur · Dimbaar via schakelaar · Regulable mediante interruptor · Dimmerabile tramite interruttore · Estompat prin comutator · Himmennettävä kytkimen · Ściemnialne za pośrednictwem przełącznika



Musterschutz · Registered model  
Modèle déposé · Beschermd model · Modelo certificado · Modello depositato · Înregistrati model · Rekisteröity malli · Zarejestrowany wzór



Starlight Effekt · Starlight effect  
Effet étoiles · Starlight effekt · Efecto estrella · Effetto stelle · Efect de "stele" · Tähti efekti · Efekt starlight



RGBW Farbwechsler · RGBW Colorchanging  
Changement de couleur RGBW · RGBW Kleurverandering · Cambio de color RGBW · Cambia colore RGBW · Schimbator de culoare RGBW · Värinvaihto RGB · Zmieniający kolor RGBW



Ohne Leuchtmittel · Lamp(s) excluded  
Sans ampoule(s) · Zonder lichtbron(nen) · Sin bombilla(s) · Lampadina Esclusa · Fara bec (s) · Ilman polttimo (s) · Bez żarówki (s)



SWITCH DIM TO WARM  
Lichtfarbe mit Schalter einstellbar · Light color adjustable with switch  
Couleur de lumière réglable avec interrupteur · Lichtkleur instelbaar met schakelaar · Color de la luz ajustable con interruptor · Colore della luce regolabile con interruttore · Culoarea luminii reglabila cu un comutator · Valon väri säädettävällä kytkimellä · Kolor światła regulowane z przełącznikiem



Ausziehbar · Extendible  
extensible · Verlengbaar · Extensible · Estensibile · extensibila · Jatkettava · Rozsuwalny



Memory Funktion · Memory function  
fonction mémoire · Geheugen functie · Función de memoria · Funzione memorizzazione · funcția memorie · Muistitoiminto · Funkcja pamięci



indirekte Beleuchtung · indirect lighting  
lumière indirecte · indirecte belichting · Iluminación indirecta · Illuminazione a scomparsa · iluminat indirect · epäsuora valaistus · oświetlenie pośrednie



DIP SWITCH  
Lichtfarben direkt an der Leuchte einstellbar · Colours directly adjustable at the lamp  
Les couleurs de la lumière peuvent être réglées directement sur le luminaire · Lichtkleuren direct instelbaar op de lamp · Tonalidades de luz ajustables directamente en la lámpara · Colori della luce regolabili direttamente sulla lampada · Culori ale luminii reglabile direct de la bec · Valon väri asetettavissa suoraan valaisimesta · Barwy światła można ustawić bezpośrednio na oprawie



## LED SWITCH DIMMER

# DIMMEN OHNE DIMMER DIMMING WITHOUT DIMMER

630



100%

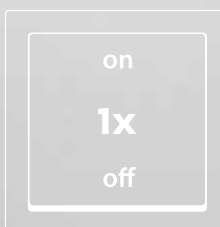

Licht einschalten  
Switch on the light



50%



Mehrmals Licht aus- und sofort wieder einschalten  
Switch off the light and switch it immediately on again



25%



Helligkeit bequem mit jedem  
herkömmlichen Lichtschalter steuern

Adjusting the desired level of brightness with any  
conventional light switch



# DIP SWITCH

Mittels DIP SWITCH können drei Lichtfarben (Warmweiß, Neutralweiß, Tageslichtweiß) über einen Schalter direkt an der Leuchte eingestellt werden.

The DIP SWITCH directly sets the luminaire's three light colours (warm, neutral and daylight white).

631



2.300K  
Warmweiß · warm

3.000K  
Neutralweiß · neutral

4.000K  
Tageslichtweiß · daylight white



# GARANTIEERKLÄRUNG

Warranty Statement · Déclaration de garantie · Garantieverklaring ·  
Declaración de garantía · Dichiarazione di garanzia ·  
Declarație de garanție · Takuuehdot · Oświadczenie o gwarancji

632

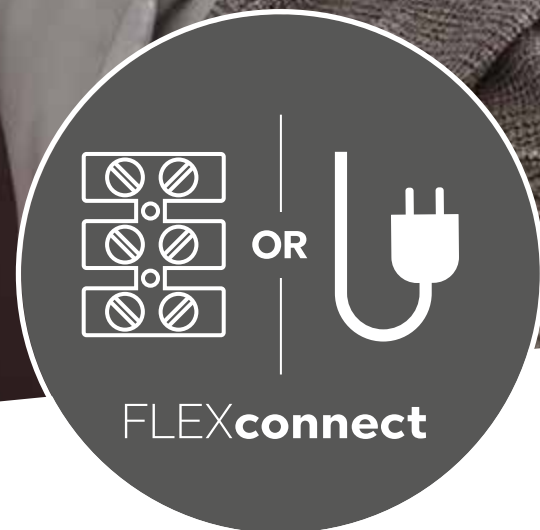

Diese Wandleuchte ist sowohl für den Festanschluss, als auch für den Betrieb mit Steckerzuleitung geeignet.

This wall light is suitable both for a fixed power connection, as well as for the connection of a plug-in power cable.

Cette applique convient à la fois pour une connexion d'alimentation fixe, ainsi que pour la connexion d'un câble d'alimentation enfichable.

Deze wandlamp is zowel geschikt voor een vaste stroomaansluiting als voor het aansluiten van een plug-in voedingskabel.

Esta luz de pared es adecuada tanto para una conexión de alimentación fija como para la conexión por cable de alimentación

Questa lampada da parete è adatta sia per una connessione di alimentazione fissa, sia per la connessione di un cavo di alimentazione plug-in.

Aceasta aplica este potrivita atat pentru a fi montata direct la sursa de curent, dar si pentru a fi conectata printr-un cablu de curent la priza.

Tämä seinävalaisin voidaan asentaa kiinteästi kytkentäriman avulla tai käyttämällä mukana tulevaa liitosjohtoa.

Ta lampa ścienna jest odpowiednia zarówno do podłączenia na stałe, jak również do eksploatacji przy użyciu przewodu z wtyczką.



TRIO übernimmt gegenüber Verbrauchern für alle Leuchten mit fest verbauten LEDs eine freiwillige Funktionsgarantie von 5 Jahren. Nähere Informationen hierzu finden Sie in der Garantieerklärung auf unserer Internetseite.  
[www.trio-leuchten.de](http://www.trio-leuchten.de)

TRIO gives consumers a voluntary functional guarantee of 5 years for all luminaires with permanently installed LEDs. For further information, please visit our website.  
[www.trio-lighting.com](http://www.trio-lighting.com)

TRIO donne aux consommateurs une garantie de fonctionnement de 5 ans pour tous les luminaires disposant de LED permanentes. Pour plus d'information, consultez notre site.  
[www.trio-lighting.com](http://www.trio-lighting.com)

TRIO biedt consumenten een vrijwillige functionele garantie van 5 jaar op alle verlichtingstoestellen met permanent geïnstalleerde leds. Voor meer informatie, consulteer onze website.  
[www.trio-lighting.com](http://www.trio-lighting.com)

TRIO ofrece a los usuarios una garantía funcional de 5 años en todos sus artículos de iluminación que cuentan con luces LED instaladas de forma permanente. Para más información, por favor visite nuestra página web.  
[www.trio-lighting.com](http://www.trio-lighting.com)

TRIO offre ai consumatori una garanzia di funzionamento facoltativa di 5 anni per tutti gli apparecchi LED installati in modo permanente. Per ulteriori informazioni, vi preghiamo di visitare il nostro sito web.  
[www.trio-lighting.com](http://www.trio-lighting.com)

TRIO oferă consumatorilor o garanție voluntară operațională de 5 ani pentru toate corpurile de iluminat cu LED-uri permanent instalate. Pentru mai multe detalii, va rugăm să vizitați site-ul TRIO.  
[www.trio-lighting.com](http://www.trio-lighting.com)

TRIO myöntää kuluttajille vapaaehtoisin 5 vuoden toimintakuun kaikille pysyvästi asennetuille LED-valoille. Lisätietoja verkkosivuiltamme.  
[www.trio-lighting.com](http://www.trio-lighting.com)

TRIO daje konsumentom dobrowolną 5-letnią gwarancję funkcjonalną na wszystkie oprawy oświetleniowe z zamontowanymi na stałe diodami LED. Na naszej stronie internetowej może Państwo uzyskać więcej informacji na ten temat.  
[www.trio-lighting.com](http://www.trio-lighting.com)

633



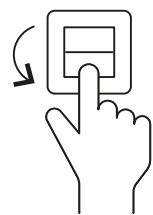

## WiZ CLICK

Simple et efficace. Deux modes d'éclairage préférés peuvent être commandés via l'interrupteur d'éclairage existant.

Eenvoudig en effectief. Twee voorkeurstellingen kunnen worden bediend via de bestaande lichtschaakelaar.

Helppoa ja tehokasta. Kaksi toivottua valo asetusta jota voidaan käyttää seinäkytkimellä.

Simplu si efectiv. Pot fi operate 2 moduri de iluminat preferate prin comutatorul de lumina existent.

Semplice ed efficace. È possibile utilizzare due modalità di illuminazione preferite tramite l'interruttore della luce esistente.

Simple y efectivo. Dos ambientes de luz preferidos pueden operar a través del interruptor convencional.

Proste i efektywne. Dwa preferowane tryby oświetlenia można obsługiwać za pomocą dostępnego przełącznika oświetlenia.

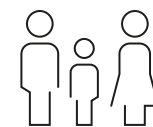

### Multiples utilisateurs

Le nombre de personnes pour contrôler les lumières peut être déterminé individuellement.

### Meerdere gebruikers

Het aantal personen dat de lampen aanstuurt, kan individueel worden ingesteld.

### Monta eri käyttäjää

WiZ käyttäjien määrä voidaan yksilöllisesti määrittää.

### Utilizatori multipli

Numarul de persoane care sa controleze luminile poate fi setat individual.

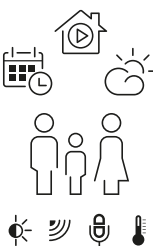

## WiZ MAGIC

Contrôle des lumières par programme horraire, par capteurs ou par simples commandes vocales. Compatible avec Amazon Alexa et Google Home.

Aansturing van de lampen met tijdschema's, door sensoren of via eenvoudige spraakopdrachten. Compatibel met Amazon Alexa en Google Home.

Valoja voi säätää aikataulutetusti, sensoreilla tai yksinkertaisilla ääni komennoilla. Yhteensopiva Amazon Alexan ja Google Homen kanssa.

Controlul luminilor prin programarea orei/timpului ,cu senzori sau printr-o simpla comanda verbala.Compatibil cu Amazon Alexa si Google Home.

Controllo delle luci secondo gli orari, con sensori o semplici comandi verbali. Compatibile con Amazon Alexa e Google Home.

Control de las luces con horarios, con sensores o por simples comandos de voz. Compatible con Alexa de Amazon y Google Home.

Ustawianie i sterowanie lampami za pomocą harmonogramów.



### Basé sur le cloud

WiZ se connecte au cloud pour stocker les préférences, partager les désirs et générer automatiquement des mises à jour.

### Cloud gebaseerd

WiZ maakt verbinding met de cloud om voorkeuren op te slaan, wensen te delen en automatische updates te genereren.

### Pilvipalveluun perustuva

WiZ ottaa yhteyden pilvipalveluun, tallentaa asetukset ja luo päivitykset automaattisesti.

### Pe baza de Cloud

WiZ te conecteaza la Cloud la magazinul preferat ,transmite dorintele si genereaza update -uri in mod automat



## WiZ APP

Installation facile et rapide. Toutes les fonctionnalités et flexibilité disponible avec l'application WiZ, téléchargeable sur App Store ou Google Play.

Eenvoudig en snel te installeren. Volledige functionaliteit en flexibiliteit met de WiZ-app - beschikbaar in de App Store of op Google Play.

Helppo ja nopea asentaa. Käyttö WiZ-aplikaatiolla - saatavissa App Storesta tai Google Play kaupasta.

Instalare usoara si rapida.Functionalitate completa si flexibilitate cu WIZ App -disponibil pe App store sau pe Google Play.

Facile e veloce da installare.Piena funzionalità e flessibilità con l'App Wiz disponibile su App Store e su Google Play.

Fácil y rápido de instalar. Amplia funcionalidad y flexibilidad con la aplicación WiZ, disponible en la App Store o en Google Play.

Prosta i szybka instalacja. Pełna funkcjonalność i elastyczność dzięki aplikacji WiZ – dostępnej w App Store lub Google Play.



### Lieux multiples

Toutes les lumières peuvent être assignées à différentes pièces et contrôlées avec précision - individuellement ou en groupe.

### Meerder woonruimtes

Alle lampen kunnen worden toegewezen aan verschillende woonruimtes en nauwkeurig worden aangestuurd - individueel of in groepen.

### Useita huoneita

Jokainen valo voidaan määrittää eri huoneelle. Hallittavissa ryhmissä tai yksittäin.

### Cateva camere

Toate luminile pot fi atribuite mai multor camere diferite si pot fi controlate cu precizie -individual sai in grupuri



## WiZ MOTE

Contrôle via la télécommande et possibilité de sauvegarder quatre modes d'éclairage favoris.

Aansturen via de afstandsbediening en mogelijkheid om vier favoriete licht instellingen te bewaren.

Toimintojen säätö kaukosäätimellä ja mahdollisuus tallentaa neljä valo asetusta.

Controlul prin telecomanda si posibilitatea de a memora/salva 4 moduri favorite.

Controllo tramite telecomando e possibilità di salvare quattro modalità luce preferite.

Control vía mando a distancia y con posibilidad de guardar 4 ambientes favoritos.

Możliwość sterowania za pomocą pilota i zapisywania czterech preferowanych trybów oświetlenia.

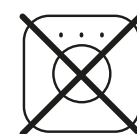

### Pas besoin de pont

Il n'y a pas besoin d'un dispositif supplémentaire pour contrôler les lumières.

### Geen hub nodig

Er is geen extra apparaat nodig om de lampen aan te sturen.

### Ei tarvetta erilliselle keskukselle

Ei tarvetta erilliselle keskukselle valojen säätämiseen.

### Nu e nevoie de nici un punct central

Nu e nevoie de o punte sau hub pentru a controla luminile



### Résidences multiples

Contrôlez et commandez plusieurs résidences simultanément et de n'importe où. Que ce soit votre propre maison ou votre deuxième résidence.

### Meerdere locaties

Controleren en aansturen van meerdere locaties tegelijkertijd en overal. Uw thuis of uw vakantiehuis.

### Useita sijainteja

Voit hallita useita sijainteja, kotiasi tai kesäasuntoasi samanaikaisesti.

### Locatii Multiple

Control si comanda a locatiilor multiple simultan si de oriunde .Fie ca te afli acasa sau in casa de vacanta

### Molteplici Location

Controlla e comanda più sedi contemporaneamente e da qualsiasi luogo. Che tu sia casa tua o la tua casa vacanza.

### Múltiples localizaciones

Control y cambio en múltiples localizaciones simultáneamente, tanto tu casa como en tu segunda residencia.

### Kilka lokalizacji

Kontrola i sterowanie z kilku lokalizacji jednocześnie i zewsząd. Czy to z własnego domu, czy też z wakacyjnego mieszkania.



### Technologie Wi-Fi

WiZ utilise la technologie Wi-Fi comme une solution sans fil sécurisée, indépendante, abordable et facile à installer.

### Wi-Fi-technologie

WiZ gebruikt Wi-Fi-technologie als een veilige, onafhankelijke, betaalbare en eenvoudige te installeren draadloze oplossing.

### Wi-Fi teknologia

WiZ käyttää Wi-Fi teknologiaa turvallisena, itsenäisenä, edullisena ja helppo käyttöisenä langattomana ratkaisuna.

### Technologie Wi-Fi

WiZ foloseste tehnologia Wi-Fi ca o solutie de internet sigura, independenta ,permisiva si usor de instalat.

### Molteplici Utenti

Il numero di persone per controllare le luci può essere impostato individualmente.

### Múltiples usuarios

El número de personas que controlan las luces se puede configurar individualmente.

### Kilku użytkowników

Liczba użytkowników mogących sterować lampami może być określana indywidualnie.

### Basato sul Cloud

WiZ si connette al cloud per memorizzare le preferenze, condividere desideri e generare automaticamente gli aggiornamenti.

### Basado en la nube

WiZ conecta con la nube para guardar tus preferencias, comparte y genera actualizaciones automáticamente.

### Oparte na chmurze

WiZ łączy się z chmurą, aby zapisywać preferencje, rozdzielać zyczenia i automatycznie generować aktualizacje.

### Numerose stanze

Tutte le luci possono essere assegnate a stanze diverse e controllate con precisione - individualmente o in gruppi.

### Varias habitaciones

Todas las luces pueden ser asignadas a diferentes habitaciones y controladas con precisión - individualmente o en grupo

### Kilka pomieszczeń

Wszystkie lampy mogą być przyporządkowywane do różnych pomieszczeń i precyzyjnie sterowane – pojedynczo lub w grupach.

### Non sono necessari altri hub

Non è necessario un ponte o un hub aggiuntivo per controllare le luci

### No necesaria una unidad central

No es necesario una conexión adicional o unidad central para controlar las luces

### Bez konieczności stosowania dodatkowych mostków

Do sterowania lampami nie jest potrzebny żaden dodatkowy mostek.

### Tecnologia Wi-Fi

WiZ utilizza la tecnologia Wi-Fi come soluzione wireless sicura, indipendente, economica e facile da installare.

### Tecnología Wi-Fi

WiZ utiliza la tecnología Wi-Fi como una solución inalámbrica segura, independiente, asequible y fácil de instalar.

### Technologia WLAN

WiZ używa technologii „WLAN” jako bezpiecznego, niezależnego, niskonakładowego i łatwego w instalacji rozwiązania radiowego.







Seite Page	Artikel-Nr. Product No.	EAN-Nummer EAN-Number	Ersatzteile Spare parts
152	101000324	4017807504675	G1010-01
152	101000524	4017807504682	G1010-01
232	101600506	4017807430165	
232	101600806	4017807430172	
227	101700332	4017807522730	
227	101700532	4017807522747	
234	102000403	4017807387919	
234	102000405	4017807387926	
156	110300428	4017807369151	
228	110600331	4017807343656	92712-01
228	110600378	4017807343663	92712-78
228	110600531	4017807343670	92712-01
228	110600578	4017807343687	92712-78
158	110700328	4017807354140	92809
158	110700528	4017807354164	92809
229	112900531	4017807504941	
229	112900542	4017807509328	
229	112900931	4017807504934	
229	112900942	4017807509335	
386	200200132	4017807463019	
387	200300132	4017807462982	
409	200400100	4017807398694	92860
386	200600132	4017807462821	S2006-02
159	200700128	4017807354188	92809
404	200970124	4017807211832	92396
411	201000101	4017807409642	
410	201100201	4017807409666	
188	201200100	4017807398632	92854
232	201600206	4017807430158	
168	202000108	4017807436051	G2020-01
166	202000132	4017807506372	G2020-01
166	202000142	4017807432893	G2020-54
408	202400106	4017807244908	92579
189	202500101	4017807364927	92831-20
385	202670107	4017807524017	
385	202670108	4017807526547	
385	202670131	4017807524055	
385	202670132	4017807524079	
285	203000132	4017807522716	
250	203000230	4017807507041	
185	204400101	4017807364972	92830-22
403	204700101	4017807276541	92717-13
252	205570167	4017807442540	
252	205570267	4017807442564	
378	206400279	4017807364361	
378	206500279	4017807364378	
396	206600278	4017807364347	
288	207000188	4017807356076	
384	207500179	4017807382860	
384	207500189	4017807382877	
190	207800100	4017807189148	92259-20
160	208070131	4017807407235	
160	208070132	4017807407242	
186	208700179	4017807385342	92920-79
186	208700189	4017807385359	92920-89

Seite Page	Artikel-Nr. Product No.	EAN-Nummer EAN-Number	Ersatzteile Spare parts
469	208870132	4017807388473	
108	209100107	4017807398564	S5091-01
108	209100108	4017807398571	S5091-01
258	209500167	4017807488906	
182	212200100	4017807522013	G2122-52
513	212400201	4017807408799	
515	212400204	4017807490510	
515	212400207	4017807408850	
513	212400224	4017807408867	
513	212400232	4017807408812	
376	212600130	4017807526288	G21261-01
376	212600156	4017807526561	G21261-01
376	212600230	4017807526318	G21262-01
376	212600256	4017807526578	G21262-01
405	212700104	4017807522129	G21271-01
405	212700107	4017807522112	G21271-01
405	212700204	4017807522143	G21272-01
405	212700207	4017807522136	G21272-01
422	214470107	4017807539493	S2144-01
422	214470108	4017807539523	S2144-01
422	214470132	4017807539554	S2144-01
401	220810201	4017807258363	92335
401	220810205	4017807258370	92335
382	222270231	4017807387414	
382	222270232	4017807387421	
382	222370231	4017807387025	
382	222370232	4017807387032	
383	222570231	4017807399875	
383	222570232	4017807399882	
397	223210131	4017807386974	
397	223210132	4017807386981	
393	223310105	4017807371765	
393	223310131	4017807371772	
393	223310132	4017807371789	
392	223410131	4017807303025	
392	223410132	4017807306309	
134	223510131	4017807421859	
134	223510132	4017807421910	
134	223510231	4017807421965	
134	223510232	4017807421996	
251	223710130	4017807441871	
251	223790130	4017807441895	
378	223810279	4017807299472	
395	223910132	4017807451955	
395	223910167	4017807441147	
379	224110179	4017807329018	
330	224210102	4017807465914	
330	224290102	4017807465921	
390	224810131	4017807502749	
390	224810132	4017807502756	
390	224810167	4017807502763	
390	224819131	4017807502770	
390	224819132	4017807502787	
390	224819167	4017807502794	
394	224910231	4017807454413	

Seite Page	Artikel-Nr. Product No.	EAN-Nummer EAN-Number	Ersatzteile Spare parts
394	224910232	4017807454437	
399	225172924	4017807404517	
399	225172931	4017807404555	
399	225172942	4017807433401	
399	225174724	4017807404586	
399	225174731	4017807404593	
399	225174742	4017807433425	
388	225210104	4017807256314	
388	225210107	4017807256338	
398	225271007	4017807468823	
398	225271031	4017807468830	
398	225271507	4017807468878	
398	225271531	4017807468885	
398	225272007	4017807468908	
398	225272031	4017807468915	
396	225510207	4017807277913	
381	229210207	4017807413304	
381	229210231	4017807413281	
381	229210232	4017807413298	
100	241670132	4017807542516	
68	241810205	4017807541793	
66	241810208	4017807541861	
300	242910180	4017807550726	
404	2502211-07	4017807103908	9413-01
402	2522011-06	4017807080797	92105
402	2523011-01	4017807094756	9327-01
59	253310105	4017807464443	92873IR
59	253310131	4017807464481	92873IR
59	253310132	4017807464528	92873IR
58	255410207	4017807415162	92873IR
128	271170201	4017807247251	92765-01
128	271170202	4017807247268	92765-02
128	271170211	4017807508680	92765-11
380	271470207	4017807374681	92940-01
380	271470279	4017807374698	92940-02
417	272970401	4017807284652	
417	272970487	4017807284669	
417	272970701	4017807284676	
417	272970787	4017807284683	
419	273070401	4017807284690	
419	273070701	4017807284706	
419	273071301	4017807284713	
419	273071801	4017807284720	
416	273170301	4017807284737	
416	273170387	4017807284744	
416	273170401	4017807284751	
416	273170487	4017807284768	
415	273271201	4017807329087	
415	273271801	4017807329094	
418	273370307	4017807284799	
359	274510107	4017807381559	
400	274670105	4017807293968	
400	274670205	4017807293975	
460	274770107	4017807390049	
460	274770132	4017807390056	

Seite Page	Artikel-Nr. Product No.	EAN-Nummer EAN-Number	Ersatzteile Spare parts
400	274813005	4017807414790	
92	275510207	4017807455830	
92	275510232	4017807455823	
389	279770104	4017807275346	
389	279770107	4017807275353	
389	279770108	4017807275360	
389	279770132	4017807542363	
604	2803021-06	4017807147599	9579-01
604	2803031-06	4017807147605	9579
586	281570606	4017807245967	
586	281570906	4017807245950	
576	282410106	4017807280821	
576	282410206	4017807280838	
596	282990106	4017807345070	
579	283110106	4017807382846	
579	283110132	4017807508000	
579	283110206	4017807382853	
579	283110232	4017807508024	
588	283270106	4017807384048	
588	283270132	4017807508116	
588	283270206	4017807384055	
588	283270232	4017807508123	
588	283270306	4017807384062	
588	283270332	4017807508154	
593	283400106	4017807508246	
593	283400132	4017807508253	
592	283500106	4017807513967	
592	283500132	4017807513998	
597	283600406	4017807514018	
575	283770106	4017807508079	
575	283770132	4017807508086	
575	283779106	4017807508093	
575	283779132	4017807508109	
582	283811206	4017807507997	
582	283811232	4017807507980	
582	283814206	4017807507959	
582	283814232	4017807507942	
582	283817906	4017807507966	
582	283817932	4017807507973	
580	283916006	4017807507904	
580	283916032	4017807507911	
580	283919006	4017807507928	
580	283919032	4017807507935	
584	284071206	4017807507638	
584	284071232	4017807507645	
584	284074206	4017807507676	
584	284074232	4017807507683	
584	284077906	4017807507652	
584	284077932	4017807507669	
590	284114006	4017807507591	D2841-06
590	284114032	4017807507607	D2841-32
590	284116006	4017807507614	D2841-06
590	284116032	4017807507621	D2841-32
165	300500104	4017807267112	
178	300600331	4017807467338	G30062-52



Seite Page	Artikel-Nr. Product No.	EAN-Nummer EAN-Number	Ersatzteile Spare parts
178	300600342	4017807467345	G30062-54
290	300700102	4017807298666	
290	300900101	4017807298673	
290	300900102	4017807298680	
271	301000367	4017807478167	G3010-52
276	301200101	4017807502626	S3012-01
277	301200201	4017807502633	S3012-01
188	301200300	4017807398649	92855
224	301300142	4017807390322	
224	301300342	4017807390346	
224	301300442	4017807390353	
242	301400101	4017807195422	92270-01
243	301700107	4017807196009	9408-01
243	301700108	4017807196016	9408-01
261	301900467	4017807502602	
168	302000308	4017807436112	G2020-01
167	302000332	4017807506389	G2020-01
167	302000342	4017807433067	G2020-54
168	302000608	4017807522778	G2020-01
166	302000632	4017807522754	G2020-01
166	302000642	4017807522761	G2020-54
278	302100130	4017807451252	S30211-01
278	302100430	4017807451269	S30212-01
222	302400404	4017807523355	
221	302400407	4017807523416	
221	302400431	4017807523492	
221	302400432	4017807523515	
222	302400480	4017807523454	
222	302400604	4017807523577	
221	302400607	4017807523591	
221	302400631	4017807523638	
221	302400632	4017807523652	
222	302400680	4017807523614	
189	302500301	4017807364934	
286	302900102	4017807292497	92779
285	303000132	4017807476781	
285	303090132	4017807476798	
125	303300101	4017807288292	92989-01
125	303300102	4017807288308	
125	303300111	4017807508703	92989-11
255	303400167	4017807425376	
254	303400367	4017807425383	
135	303500331	4017807422061	C3035-01
135	303500332	4017807422078	C3035-01
294	303700104	4017807286601	
294	303700161	4017807286618	
294	303700162	4017807286625	
244	304100100	4017807247411	92634
244	304100106	4017807247404	92634-06
275	304300132	4017807467499	
274	304300432	4017807467567	
275	304330332	4017807467512	
185	304400201	4017807364989	92830-040
295	304500104	4017807286151	92740
295	304500161	4017807286168	92740

Seite Page	Artikel-Nr. Product No.	EAN-Nummer EAN-Number	Ersatzteile Spare parts
295	304500162	4017807286175	92740
236	304800142	4017807277944	92720-42
268	305300488	4017807445237	
117	305400401	4017807336948	
117	305400411	4017807336955	93782-11
117	305400441	4017807391022	
117	305400479	4017807336962	93782-79
117	305400489	4017807336979	93782-89
253	305500467	4017807441093	92987
237	305900126	4017807330816	
237	305900130	4017807330809	
231	306200832	4017807467864	
148	306700602	4017807373912	
148	306700632	4017807364392	
149	306700732	4017807399905	
288	307000188	4017807356090	
288	307000688	4017807356106	
244	307290101	4017807343748	
238	307400331	4017807408010	
172	307601206	4017807426861	G50761-54
190	307800100	4017807189155	92258-30
190	307804100	4017807190083	92258-40
150	307900432	4017807502701	
238	308000132	4017807288827	
270	308100567	4017807451221	
119	308200179	4017807392517	
104	308300307	4017807510638	92980-01 92983-07 92976-11
106	308300308	4017807510645	92980-01 92983-08 92976-01
170	308500542	4017807468601	G40342-54
170	308590342	4017807468625	G40342-54
235	308600706	4017807378306	B3086-00 P3086-06
187	308700189	4017807385373	92925-89
187	308700289	4017807385397	92924-89
130	308900331	4017807405224	C0089-01
130	308900342	4017807425451	C0089-01
130	308900631	4017807425581	C3089-01
130	308900642	4017807425604	C3089-01
266	309000167	4017807473421	
266	309090167	4017807473414	
239	309300302	4017807354102	92836-04 92836-05 92836-06 92836-07
120	309400317	4017807423723	
258	309500167	4017807488937	
258	309500467	4017807488951	
132	309800431	4017807387681	92887
132	309800432	4017807387698	92887
142	309900631	4017807330946	
142	309900632	4017807330953	92943

Seite Page	Artikel-Nr. Product No.	EAN-Nummer EAN-Number	Ersatzteile Spare parts
287	310100104	4017807408607	
293	310100162	4017807356021	
287	310100204	4017807408591	
293	310100562	4017807356045	
214	310300132	4017807532951	G3103-54
214	310300532	4017807522471	G3103-54
214	310390332	4017807522488	G3103-54
180	310600101	4017807504453	G0106-31
180	310600132	4017807427264	G0106-54
180	310600154	4017807507478	G0106-54
180	310600401	4017807504538	G0106-31
180	310600432	4017807427288	G0106-54
180	310600454	4017807507515	G0106-54
180	310630301	4017807504491	G0106-31
180	310630332	4017807435696	G0106-54
180	310630354	4017807507492	G0106-54
265	310700432	4017807502848	
265	310730332	4017807502831	
226	310800108	4017807503845	
226	310800308	4017807503852	
226	310890108	4017807503838	S31082-08
286	310900111	4017807349160	
140	311100308	4017807537826	
140	311100367	4017807537703	
175	311210506	4017807367768	92829-40 92833-10 92833-12 92833-14
174	311210606	4017807367775	92829-50 92833-10 92833-12 92833-14 92833-16
110	311400132	4017807538526	
110	311400432	4017807538410	
145	311900632	4017807536607	
145	311900732	4017807537949	
280	312200136	4017807544817	
182	312200200	4017807522006	G3122-52
280	312200336	4017807544800	
284	312300136	4017807504620	S3123-36
220	312400101	4017807408713	
220	312400107	4017807408737	
220	312400132	4017807408720	
220	312400401	4017807408751	
220	312400407	4017807408775	
220	312400432	4017807408768	
223	312490407	4017807523676	
223	312490431	4017807523690	
223	312490432	4017807523720	
223	312490607	4017807523744	
223	312490631	4017807523805	
223	312490632	4017807523843	
262	312700132	4017807502725	
262	312700432	4017807502718	

Seite Page	Artikel-Nr. Product No.	EAN-Nummer EAN-Number	Ersatzteile Spare parts
216	313100531	4017807538496	G3131-01
216	313100532	4017807538519	G3131-02
216	313100931	4017807538489	G3131-01
216	313100932	4017807538472	G3131-02
162	313300307	4017807503647	
162	313300308	4017807503678	S3133-08
162	313300332	4017807503630	
162	313300407	4017807503715	
162	313300408	4017807503739	
162	313300432	4017807503692	
218	313400107	4017807504293	
218	313400131	4017807504255	
218	313400132	4017807504279	
218	313400407	4017807504354	
218	313400431	4017807504316	
218	313400432	4017807504330	
218	313400607	4017807504415	
218	313400631	4017807504378	
218	313400632	4017807504392	
272	313800332	4017807502855	
272	313800532	4017807502862	
138	313900132	4017807505061	S3139-32 G3139-01
138	313900232	4017807505085	S3139-32 G3139-01
249	314300430	4017807538915	
176	315190132	4017807539646	G3151-57
230	315200109	4017807288001	92735-09
230	315200179	4017807287998	92735-79
282	315900132	4017807540246	
282	315900142	4017807540277	
273	316500432	4017807540604	
212	317000332	4017807542271	G31701-57 G31702-57 G31703-57
212	317000632	4017807542295	G31701-57 G31702-57 G31703-57
212	317000832	4017807542301	G31701-57 G31702-57 G31703-57
90	320310307	4017807487909	
90	320310308	4017807487916	
90	320310331	4017807487930	
90	320310332	4017807487923	
70	321210107	4017807454000	
70	321210108	4017807461145	
204	321611131	4017807468724	92957
204	321611132	4017807468731	
204	321691131	4017807468748	
204	321691132	4017807468755	
77	321710107	4017807430486	
77	321710142	4017807430493	
200	321910207	4017807453560	
200	321910242	4017807453577	



Seite Page	Artikel-Nr. Product No.	EAN-Nummer EAN-Number	Ersatzteile Spare parts
200	321910307	4017807453584	
200	321910342	4017807453607	
83	322610232	4017807424324	
82	322610431	4017807424294	
82	322610432	4017807424300	
84	322610489	4017807497809	
96	322910532	4017807524963	
199	323610307	4017807506365	
199	323610331	4017807506341	
199	323610332	4017807506358	
251	323710130	4017807451191	
79	324610131	4017807472912	D0246-31
79	324610132	4017807470932	D0246-32
79	324610179	4017807470949	D0246-79
240	324810407	4017807257649	98249 98248
76	325010105	4017807422627	
76	325010132	4017807422634	
202	325110131	4017807467758	
202	325110132	4017807467789	
202	325110179	4017807467796	
208	325510407	4017807367973	92833 92944
208	325510507	4017807367980	92833 92944
203	325610305	4017807388022	
72	326210107	4017807505221	
72	326210131	4017807505207	
72	326210132	4017807505214	
98	326410130	4017807505412	
65	326510107	4017807510034	
65	326510108	4017807510041	
65	326510142	4017807510058	
65	326510207	4017807510065	
65	326510208	4017807510072	
65	326510242	4017807510089	
65	326510307	4017807510096	
65	326510308	4017807510102	
65	326510342	4017807510119	
103	326610207	4017807505467	
103	326610232	4017807505474	
88	326810131	4017807506525	
88	326810132	4017807506518	
210	327210305	4017807504200	
210	327210332	4017807504194	
242	3407011-07	4017807103724	9408-01
136	340910131	4017807537956	
137	340910132	4017807537970	
136	340910331	4017807537994	
137	340910332	4017807538106	
86	341210305	4017807540161	
86	341210308	4017807540086	
101	341610132	4017807542455	
69	341810205	4017807540710	
67	341810208	4017807540734	

Seite Page	Artikel-Nr. Product No.	EAN-Nummer EAN-Number	Ersatzteile Spare parts
196	342010107	4017807542066	G3420-01
196	342010108	4017807542080	G3420-01
194	342010132	4017807542073	G3420-57
196	342010207	4017807542097	G3420-01
196	342010208	4017807542134	G3420-01
194	342010232	4017807542127	G3420-57
196	342010307	4017807542141	G3420-01
196	342010308	4017807542158	G3420-01
194	342010332	4017807542172	G3420-57
211	342710205	4017807542318	
211	342710208	4017807542233	
245	3490400-00	4017807062465	
245	3491400-00	4017807081541	
47	352710307	4017807453775	92873IR
47	352710342	4017807473308	92873IR
245	3590010-01	4017807062496	
240	371010307	4017807281750	92734-01 92910
240	371010308	4017807281767	92734-01 92910
240	371010407	4017807281781	92734-01 92910
240	371010408	4017807281798	92734-01 92910
74	371310105	4017807445336	
74	371310131	4017807451801	
74	371310142	4017807445343	
241	3751031-07	4017807137729	9350
241	3751041-07	4017807137736	9350
241	3751051-07	4017807169027	9350
206	375310502	4017807504446	
206	375310505	4017807504439	
206	375310507	4017807472226	
206	375310508	4017807481839	
206	375310532	4017807472233	
93	375510407	4017807469844	
93	375510432	4017807469882	
209	379190707	4017807362831	
209	379190732	4017807471229	
123	393900317	4017807505504	S3939-01 S3939-02 S3939-11
123	393900517	4017807505511	S693920-11 S693925-02 S693930-02 S693935-01 S693940-01
431	400200107	4017807368390	92820-01 92820
431	400200108	4017807378320	92820-01 92820-08
430	400400107	4017807423211	S4004-11
430	400400132	4017807423228	S4004-11
165	400500104	4017807268621	
154	401000224	4017807504712	G4010-01

Seite Page	Artikel-Nr. Product No.	EAN-Nummer EAN-Number	Ersatzteile Spare parts
126	401100101	4017807276121	92782-01
126	401100102	4017807276138	92782-02
126	401100111	4017807505580	S4011-11
277	401200101	4017807502640	S3012-01
435	401600131	4017807489422	S4016-01
435	401600132	4017807489439	S4016-02
434	401700317	4017807502541	S4017-01 S4017-02 S4017-11 S4017-17
260	401900367	4017807502619	
168	402000108	4017807436099	G4020-01
167	402000132	4017807506426	G4020-01
167	402000142	4017807433012	G4020-54
264	402690167	4017807502688	
285	403000132	4017807468076	
254	403400167	4017807426854	
474	403400317	4017807422986	G40341-13 G40342-19 G40343-54
474	403400354	4017807422948	G40341-54 G40342-54 G40343-54
256	403490167	4017807430226	
471	4035011-04	4017807090604	92174
471	4035011-07	4017807090611	92174
471	4035011-08	4017807090628	92174
127	403900201	4017807433654	S40391-01 S40392-01
127	403900208	4017807494556	S40391-81 S40392-81
127	403900211	4017807433661	S40391-11 S40392-11
275	404300332	4017807467727	
468	404600332	4017807377361	
253	405500367	4017807466751	92988
148	406700632	4017807364415	
172	407690906	4017807423150	G5076-54
473	407800132	4017807303216	92784-02
150	407900332	4017807502695	
161	408000131	4017807407297	
161	408000132	4017807407303	
118	408200179	4017807392593	
119	408290179	4017807392616	
104	408300307	4017807510676	92981-07 92976-11
106	408300308	4017807510683	92981-08 92976-01
170	408500542	4017807468670	G40342-54
469	408800332	4017807390148	
266	409000167	4017807466843	
109	409100307	4017807389654	92865-07
109	409100308	4017807389661	92865-08
258	409500167	4017807488920	

Seite Page	Artikel-Nr. Product No.	EAN-Nummer EAN-Number	Ersatzteile Spare parts
175	411210406	4017807367836	92829-40 92833-10 92833-12 92833-14
112	411400132	4017807538618	
112	411400232	4017807538731	
110	411490132	4017807538687	
439	411700108	4017807522501	S4117-08
464	412400107	4017807488777	
464	412400108	4017807488760	
464	412400131	4017807488784	
464	412400132	4017807488791	
262	412700132	4017807502732	
162	413300107	4017807507416	
162	413300108	4017807507393	
162	413300132	4017807507409	
138	413900132	4017807505092	S3139-32 G3139-01
249	414300530	4017807538861	
422	414400107	4017807539448	S4144-01
422	414400108	4017807539455	S4144-01
422	414400132	4017807539486	S4144-01
424	415700307	4017807539929	S4157-01
424	415700332	4017807539950	S4157-01
433	416900207	4017807541724	S41691-07 S41692-07
433	416900208	4017807541717	S41691-08 S41692-08
527	411900231	4017807523041	
145	411900232	4017807523058	
438	4200011-06	4017807105650	913244 913240
467	420490107	4017807295337	9243-01
467	420490132	4017807382525	9243-01
459	420810107	4017807367614	
458	420910107	4017807367591	
458	420910108	4017807367607	
436	421100301	4017807194494	92287F-01 92287S-01
436	421100302	4017807194500	92287F-02 92287S-02
71	421210107	4017807454024	
71	421210108	4017807461169	
451	421910207	4017807267532	92685 92685-01 92754-01 92754
451	421910228	4017807267549	92685 92685-01 92754-01 92754
462	422410107	4017807358599	
462	422410108	4017807358605	
83	422610531	4017807423822	
83	422610532	4017807423853	



Seite Page	Artikel-Nr. Product No.	EAN-Nummer EAN-Number	Ersatzteile Spare parts
84	422610589	4017807497847	
443	422710307	4017807343076	
443	422710308	4017807354270	
426	422970206	4017807368260	92946 92821
456	423310107	4017807505825	
456	423310108	4017807506105	
456	423310132	4017807506099	
80	423410107	4017807506297	
80	423410131	4017807506310	
80	423410132	4017807506327	
448	424210304	4017807467635	
448	424210307	4017807467628	
448	424210332	4017807467598	
444	424310204	4017807525199	
444	424310207	4017807525182	
444	424310208	4017807525205	
444	424310232	4017807525212	
79	424610132	4017807470833	D0246-32
79	424610179	4017807470901	D0246-79
470	424810107	4017807257687	98249 98248
470	424810207	4017807257700	98249 98248
453	424910207	4017807353938	92928
446	425610204	4017807525243	
446	425610207	4017807525229	
446	425610208	4017807525250	
446	425610232	4017807525267	
73	426219107	4017807505276	
73	426219131	4017807505252	
73	426219132	4017807505269	
98	426410130	4017807505450	
450	426410207	4017807244717	92730
450	426410208	4017807244724	92730
64	426510104	4017807525342	
64	426510107	4017807525335	
64	426510108	4017807525359	
64	426510142	4017807525366	
62	426510204	4017807525281	
62	426510207	4017807525274	
62	426510208	4017807525298	
62	426510242	4017807525311	
440	426511832	4017807467390	
88	426810131	4017807506495	
88	426810132	4017807506501	
441	427511801	4017807274332	92777
441	427511802	4017807274349	92777
441	427511887	4017807279511	92777
94	427710505	4017807451672	
94	427710532	4017807442205	
450	429110104	4017807267518	92694
450	429110107	4017807267525	92694
86	441210305	4017807540413	
86	441210308	4017807540390	

Seite Page	Artikel-Nr. Product No.	EAN-Nummer EAN-Number	Ersatzteile Spare parts
101	441610132	4017807542530	
69	441810205	4017807540765	
67	441810208	4017807541731	
57	451850101	4017807407464	92873IR
154	4602021-24	4017807196801	92274 92274-01
126	461100101	4017807247220	92597-01
126	461100102	4017807247237	92597-02
126	461100111	4017807508673	92597-11
437	462100132	4017807398922	S4621-02
454	470310104	4017807523348	
454	470310131	4017807523324	
454	470310132	4017807523331	
78	472910106	4017807299281	
466	473190307	4017807302691	
466	473190331	4017807302707	
466	473190332	4017807382532	
472	474410179	4017807359633	
460	474790107	4017807390087	
460	474790132	4017807390094	
428	475310307	4017807380439	92844-07
428	475310379	4017807380446	92844-79
427	475410207	4017807398595	S4754-01
452	478310206	4017807336795	
431	500200107	4017807368406	92819
431	500200108	4017807378313	92819
165	500500104	4017807268669	
159	500700128	4017807354201	92809
154	501000224	4017807504729	G5010-01
129	501100101	4017807246810	
129	501100102	4017807246827	
129	501100111	4017807505535	S5011-11
276	501200101	4017807502657	S5012-01
168	502000108	4017807436075	G2020-01
166	502000132	4017807506402	G2020-01
166	502000142	4017807432992	G2020-54
278	502100130	4017807473476	S30212-01
496	5027011-01	4017807017366	
496	5027011-17	4017807051360	
496	5027011-47	4017807124941	
496	5028010-01	4017807051414	
496	5028010-02	4017807051421	
496	5028010-17	4017807051438	
496	5028010-47	4017807051445	
497	5029010-01	4017807051377	
497	5029010-47	4017807051407	
275	504300132	4017807467703	
495	504900104	4017807522570	
495	504900107	4017807522556	
495	504900131	4017807522518	
495	504900132	4017807522532	
172	507690606	4017807423112	G5076-54
161	508000131	4017807407273	
161	508000132	4017807407280	
118	508200179	4017807392555	92999

Seite Page	Artikel-Nr. Product No.	EAN-Nummer EAN-Number	Ersatzteile Spare parts
494	508300131	4017807422313	
494	508300132	4017807422337	
292	508400132	4017807387438	G5040-02
292	508400161	4017807387445	G5040-02
292	508400162	4017807387452	G5040-02
108	509100107	4017807398540	S5091-01
108	509100108	4017807398557	S5091-01
180	510600101	4017807504552	G0106-31
180	510600132	4017807427240	G0106-54
180	510600154	4017807507522	G0106-54
129	511100101	4017807246841	92807-01
129	511100102	4017807246858	92807-02
129	511100111	4017807508710	
174	511210306	4017807367829	92829-28 92833-10 92833-12
110	511400132	4017807538755	
527	511900131	4017807523072	
145	511900132	4017807523089	
280	512200136	4017807544831	
464	512400107	4017807488746	
464	512400108	4017807488753	
464	512400131	4017807488722	
464	512400132	4017807488739	
249	514300230	4017807538885	
422	514400107	4017807539301	S5144-01
422	514400108	4017807539370	S5144-01
422	514400132	4017807539400	S5144-01
176	515190132	4017807539707	G5151-57
424	515700107	4017807539882	S5157-01
424	515700132	4017807539905	S5157-01
424	515790107	4017807554977	S51571-01
424	515790132	4017807554991	S51571-01
458	520910107	4017807367577	
458	520910108	4017807367584	
71	521210107	4017807454017	
71	521210108	4017807461152	
488	522520102	4017807226775	
488	522520187	4017807226782	
82	522610331	4017807423792	
82	522610332	4017807423815	
84	522610389	4017807497823	
487	523090131	4017807502503	
487	523090132	4017807502527	
456	523310107	4017807505771	
456	523310108	4017807505818	
456	523310132	4017807505801	
480	525490106	4017807371710	92826
480	525490107	4017807371727	92826
478	525790107	4017807385663	92876
478	525790108	4017807385670	92876
62	526510104	4017807525373	
62	526510107	4017807510140	
62	526510108	4017807510157	
62	526510142	4017807510164	

Seite Page	Artikel-Nr. Product No.	EAN-Nummer EAN-Number	Ersatzteile Spare parts
88	526810131	4017807506488	
88	526810132	4017807506471	
492	527090111	4017807372328	
492	527090131	4017807372335	
493	527290101	4017807291438	
493	527290102	4017807291445	
488	527410142	4017807291513	
477	527590107	4017807371758	92825
477	527590132	4017807480313	92825
477	527590179	4017807373103	92825
489	527690131	4017807372304	
489	527690132	4017807372311	
94	527710305	4017807451665	
94	527710332	4017807442229	
486	527920101	4017807276046	
486	527920102	4017807276053	
478	529690100	4017807262032	92671-00
478	529690107	4017807262070	92671-07
479	529990103	4017807248340	92584
479	529990107	4017807248364	92584
86	541210205	4017807540284	
86	541210208	4017807540253	
101	541610132	4017807542493	
69	541810205	4017807541748	
67	541810208	4017807541762	
454	570310104	4017807523294	
454	570310131	4017807523256	
454	570310132	4017807523270	
462	572410107	4017807337006	
462	572410108	4017807345162	
78	572910106	4017807303162	
505	573190107	4017807302677	
505	573190131	4017807302684	
492	573910101	4017807275636	92839 92998
492	573910106	4017807275650	92839
472	574410179	4017807359626	
428	575310307	4017807380453	
428	575310379	4017807380460	
427	575410207	4017807398588	S5754-01
490	579790104	4017807275285	
490	579790107	4017807275322	
490	579790108	4017807275339	
490	579790132	4017807452549	
483	590100107	4017807551129	9424
483	590100132	4017807551136	9424
482	590200107	4017807551143	9426
482	590200132	4017807551150	9426
482	591000107	4017807551167	9262-01
482	591000132	4017807551174	9262-01
485	591600101	4017807551181	92281-01
485	591600102	4017807551198	92281
485	591600142	4017807551204	92281-42
476	592300107	4017807551211	9309
476	592600107	4017807551228	9321



Seite Page	Artikel-Nr. Product No.	EAN-Nummer EAN-Number	Ersatzteile Spare parts
476	592600108	4017807551235	9321
162	593400107	4017807551242	
162	593400108	4017807551259	
162	593400132	4017807551266	
116	595400101	4017807337778	93781
116	595400111	4017807337785	93781-11
116	595400141	4017807391046	93781-41
116	595400179	4017807337792	93781-79
116	595400189	4017807337808	93781-89
480	595700106	4017807551273	9610-01
480	595700107	4017807551280	9610-00
480	595700108	4017807551297	9610-00
481	599100106	4017807551303	92271-06
481	599100107	4017807551310	92271-07
481	599100108	4017807551327	92271-07
481	599100118	4017807551334	92271-18
481	599100124	4017807551341	92271-07
484	599700101	4017807551358	92934-01
484	599700115	4017807551365	
484	599700119	4017807551372	
484	599700142	4017807551389	
409	600400100	4017807398656	92856
409	600400200	4017807398663	92857
178	600600331	4017807467352	G30062-52
178	600600342	4017807467369	G30062-54
158	600700328	4017807354225	92809
152	601000324	4017807504699	G1010-01
188	601200100	4017807398601	92851
276	601200101	4017807502664	S3012-01
188	601200200	4017807398618	92852
260	601900467	4017807502596	
278	602100130	4017807491500	S30211-01
370	602300301	4017807399578	S60232-01 96023-40
370	602300345	4017807399585	S60232-45 96023-40
370	602300394	4017807399592	S60232-94 96023-40
408	602400106	4017807244915	92579-25
408	602400206	4017807244922	92579-30
189	602500101	4017807364941	92831-30
189	602500201	4017807364958	92831-40
410	603300101	4017807433784	
134	603500331	4017807422047	
134	603500332	4017807422054	
124	603900201	4017807289688	92631-30
124	603900202	4017807289695	92631-30
124	603900211	4017807505603	S60391-11
124	603900301	4017807256536	92662 92631
124	603900302	4017807256543	92662-02 92631
124	603900311	4017807505627	S60392-11 92631
124	603900501	4017807369298	92631-65

Seite Page	Artikel-Nr. Product No.	EAN-Nummer EAN-Number	Ersatzteile Spare parts
124	603900502	4017807369304	92631-65
124	603900511	4017807505634	S60393-11 92631-65
184	604400101	4017807364996	92830-30
184	604400201	4017807365009	92830-40
184	604400301	4017807365016	92830-50
342	604900331	4017807454284	
342	604900332	4017807454307	
342	604900631	4017807454345	
342	604900632	4017807454369	
116	605400501	4017807349214	93781
116	605400511	4017807349221	93781-11
116	605400541	4017807391039	
116	605400579	4017807349238	
116	605400589	4017807349245	93781-89
252	605500467	4017807442588	92987
371	605600307	4017807236996	92529
371	605600507	4017807237009	92529
148	606700632	4017807373448	
291	606900132	4017807504170	
291	606900161	4017807351781	
291	606900162	4017807356823	
291	606903032	4017807512069	
291	606903062	4017807517644	
291	606905032	4017807512038	
291	606905062	4017807517668	
172	607601206	4017807426885	G50761-54
190	607800100	4017807189216	92259-30
160	608000331	4017807412598	
160	608000332	4017807412604	
372	608100224	4017807211795	92472-01
372	608100324	4017807211788	92472
118	608200279	4017807392531	
104	608300307	4017807510652	92980-01 92985-07 92978-11
106	608300308	4017807510669	92980-01 92985-08 92978-01
186	608700189	4017807385434	92921-89
186	608700289	4017807385458	92922-89
130	608900331	4017807413717	C0089-01
130	608900342	4017807425475	C0089-01
120	609400317	4017807423730	
132	609800431	4017807387704	92887
132	609800432	4017807387711	92887
142	609900331	4017807330960	92943-01
142	609900332	4017807330984	92943
407	6101011-01	4017807017557	9218-01
407	6101011-07	4017807028393	9218-01
154	6102021-24	4017807053296	92126
156	610300428	4017807369175	
406	6105011-01	4017807053968	9285-01
406	6105021-01	4017807098440	9287-01
140	611100308	4017807537789	

Seite Page	Artikel-Nr. Product No.	EAN-Nummer EAN-Number	Ersatzteile Spare parts
140	611100367	4017807537642	
174	611210506	4017807367782	92829-40 92833-10 92833-12 92833-14
114	611400332	4017807538700	
112	611400532	4017807544572	
112	611490332	4017807544565	
374	611500201	4017807526158	S61152-01
374	611500202	4017807526165	S61152-02
374	611500301	4017807526202	S61153-01
374	611500302	4017807526219	S61153-02
146	611900632	4017807536584	
182	612200100	4017807522037	G61221-52
182	612200200	4017807522051	G61222-52
280	612200336	4017807544824	
284	612300236	4017807504637	S6123-36
512	612400501	4017807411614	
515	612400504	4017807490619	
515	612400507	4017807411638	
512	612400532	4017807411621	
510	612400580	4017807523980	
376	612600230	4017807526325	G6126-01
376	612600256	4017807526585	G6126-01
344	612900131	4017807426441	
344	612900132	4017807426465	
344	612900231	4017807426526	
344	612900232	4017807426533	
344	612900431	4017807426588	
344	612900432	4017807426595	
345	613000131	4017807426908	
345	613000132	4017807426915	
345	613000231	4017807426922	
345	613000232	4017807426939	
345	613000431	4017807426977	
345	613000432	4017807426984	
249	614300430	4017807538939	
176	615190132	4017807539660	G5151-57
282	615900232	4017807540321	
282	615900242	4017807540338	
406	6160011-00	4017807131895	9516
273	616500432	4017807540635	
351	616700306	4017807541687	G61671-57 B61671-00
351	616700506	4017807541700	G61672-57 B61672-00
407	6196011-01	4017807138238	9523-01
407	6196011-07	4017807138245	9523-07
314	620010407	4017807449525	
314	620010408	4017807550788	
314	620010431	4017807452204	
314	620010442	4017807449495	
90	620310307	4017807487862	
90	620310308	4017807487893	
90	620310331	4017807487879	

Seite Page	Artikel-Nr. Product No.	EAN-Nummer EAN-Number	Ersatzteile Spare parts
90	620310332	4017807487886	
325	620510307	4017807488586	D62051-52
325	620510331	4017807488579	D62051-52
325	620510332	4017807488562	D62051-52
70	621210107	4017807453980	
70	621210108	4017807461121	
70	621290107	4017807453997	
70	621290108	4017807461138	
503	621410505	4017807220940	92426 92389-05
77	621710107	4017807430509	
77	621710142	4017807430516	
348	621910301	4017807503975	S6219-01
348	621910302	4017807503999	S6219-02
348	621910317	4017807504019	S6219-01 S6219-02 S6219-11
348	621910501	4017807504026	S6219-01
348	621910502	4017807504033	S6219-02
348	621910517	4017807504064	S6219-01 S6219-02 S6219-11
346	621911201	4017807337105	
346	621911211	4017807337112	
346	621912401	4017807337143	92962
346	621912411	4017807337150	92962
347	621914001	4017807384468	92883IR
347	621914011	4017807384475	92883IR
347	621915501	4017807384482	92883IR
347	621915511	4017807384499	92883IR
82	622610431	4017807424270	
82	622610432	4017807424287	
84	622610489	4017807497786	
82	622610531	4017807488821	
82	622610532	4017807488838	
84	622610589	4017807497861	
373	622811528	4017807262407	92686
96	622910332	4017807524994	
96	622910532	4017807524987	
80	623410207	4017807506235	92969RD
80	623410231	4017807506242	92969RD
80	623410232	4017807506259	92969RD
80	623419207	4017807506266	92969RD
80	623419231	4017807506273	92969RD
80	623419232	4017807506280	92969RD
251	623710130	4017807451184	
329	623810431	4017807399806	
379	624110279	4017807337051	92795
76	625010105	4017807422641	
76	625010132	4017807422658	
358	625815031	4017807506457	92970RD
72	626210107	4017807505191	
72	626210131	4017807505177	
72	626210132	4017807505184	
99	626410530	4017807505429	92967RD



Seite Page	Artikel-Nr. Product No.	EAN-Nummer EAN-Number	Ersatzteile Spare parts
62	626510304	4017807538144	
62	626510307	4017807538083	
62	626510308	4017807538120	
62	626510342	4017807538168	
368	626510987	4017807245202	
368	626511287	4017807245226	
368	626512587	4017807246803	
102	626610207	4017807505481	
102	626610232	4017807505498	
310	626710531	4017807505719	
310	626710532	4017807505726	
310	626710587	4017807505733	
326	626910307	4017807506587	92996RD
326	626910332	4017807506594	92996RD
326	626919307	4017807506600	92996RD
326	626919332	4017807506617	92996RD
332	627413031	4017807525007	
332	627413032	4017807525014	
332	627413087	4017807525021	
332	627415031	4017807525038	
332	627415032	4017807525069	
332	627415087	4017807525076	
332	627417531	4017807525083	
332	627417532	4017807525090	
332	627417587	4017807525106	
366	627514000	4017807401837	6289IR-2
366	627516000	4017807401820	6289IR-2
94	627710405	4017807451702	
94	627710432	4017807442182	
94	627710505	4017807451658	
94	627710532	4017807448184	
319	628410507	4017807504071	92975RD
319	628410532	4017807504040	92975RD
364	628513001	4017807298819	6289IR-2
364	628613001	4017807298826	6289IR-2
362	628915001	4017807272307	6289IR-2 6289IR
308	629010107	4017807423426	
356	629210331	4017807525113	93000RD
356	629219331	4017807525120	93000RD
136	640910131	4017807537901	
137	640910132	4017807537925	
86	641210305	4017807539936	
86	641210308	4017807539912	
352	641412106	4017807539288	G6414-57
352	641412107	4017807539226	G6414-01
352	641412132	4017807539257	G6414-01
100	641610232	4017807542431	
68	641810205	4017807540741	
66	641810208	4017807540758	
298	641910205	4017807541939	
298	641910208	4017807541953	
304	642110331	4017807541830	
304	642110332	4017807541816	
304	642110431	4017807541908	

Seite Page	Artikel-Nr. Product No.	EAN-Nummer EAN-Number	Ersatzteile Spare parts
304	642110432	4017807541885	
300	642910280	4017807542974	
300	642910380	4017807542998	
568	650000106	4017807376210	
568	650000107	4017807376234	
568	650000108	4017807376241	
568	650000131	4017807376203	
568	650000132	4017807378061	
568	650000306	4017807376258	
568	650000307	4017807376265	
568	650000331	4017807376272	
568	650100106	4017807376302	
568	650100107	4017807376319	
568	650100108	4017807376326	
568	650100131	4017807376296	
568	650100132	4017807378078	
568	650100306	4017807376333	
568	650100307	4017807376340	
568	650100331	4017807376357	
564	650210106	4017807376388	
564	650210107	4017807376395	
564	650210131	4017807376371	
564	650210306	4017807376418	
564	650210307	4017807376425	
564	650210331	4017807376432	
564	650310106	4017807376463	
564	650310107	4017807376470	
564	650310131	4017807376456	
564	650310306	4017807376494	
564	650310307	4017807376500	
564	650310331	4017807376517	
560	650410106	4017807376630	
560	650410107	4017807376647	
560	650410131	4017807376623	
560	650410132	4017807378030	
560	650510106	4017807376753	
560	650510107	4017807376760	
560	650510131	4017807376722	
560	650510132	4017807378085	
562	650610106	4017807376869	
562	650610107	4017807376876	
562	650610131	4017807376890	
562	650610132	4017807442595	
562	650610306	4017807376906	
562	650610307	4017807376913	
562	650610331	4017807376920	
562	650710106	4017807376937	
562	650710107	4017807376944	
562	650710131	4017807376951	
562	650710132	4017807442601	
562	650710306	4017807376975	
562	650710307	4017807376968	
562	650710331	4017807376982	
50	651110207	4017807425291	92873IR
50	651110232	4017807425314	92873IR

Seite Page	Artikel-Nr. Product No.	EAN-Nummer EAN-Number	Ersatzteile Spare parts
51	651210507	4017807389753	92873IR
570	651500131	4017807455915	
570	651500132	4017807455939	
570	651600131	4017807455946	
570	651600132	4017807455977	
570	651600231	4017807456011	
570	651600232	4017807455991	
570	651600331	4017807456035	
570	651600332	4017807456059	
566	651700152	4017807425888	
566	651800152	4017807425901	
54	651914001	4017807389609	92873IR
54	651915501	4017807389616	92873IR
566	652100152	4017807425925	
566	652200152	4017807425949	
556	652310106	4017807427660	
556	652310131	4017807427677	
556	652310132	4017807504095	
556	652410106	4017807427684	
556	652410131	4017807427691	
556	652410132	4017807504101	
558	652510106	4017807427707	
558	652510131	4017807427714	
558	652510132	4017807504132	
558	652610106	4017807427721	
558	652610131	4017807427738	
558	652610132	4017807504156	
48	652610307	4017807453881	92873IR
48	652610342	4017807453751	92873IR
48	652690307	4017807453898	92873IR
48	652690342	4017807453768	
46	652710307	4017807453799	92873IR
46	652710342	4017807473339	92873IR
500	652910131	4017807473643	
500	652910132	4017807473650	
500	652910231	4017807473667	
500	652910232	4017807473674	
500	652910331	4017807473681	
500	652910332	4017807473698	
56	656010100	4017807389845	92873IR
56	656090100	4017807389869	92873IR
369	656411506	4017807371796	
369	656412406	4017807371802	
369	656511806	4017807371826	
369	656512006	4017807371833	
341	657010601	4017807294637	92840-12
341	657010607	4017807294675	92840-12
341	657011201	4017807294712	92840-18
341	657011207	4017807294729	92840-18
341	657011801	4017807294743	92840-22
341	657011807	4017807294750	92840-22
340	657110601	4017807294651	92840-12
340	657110607	4017807294668	92840-12
340	657111201	4017807294705	92840-18
340	657111207	4017807294699	92840-18

Seite Page	Artikel-Nr. Product No.	EAN-Nummer EAN-Number	Ersatzteile Spare parts
340	657111801	4017807294767	92840-22
340	657111807	4017807294774	92840-22
53	657411107	4017807436358	92873IR
52	657413007	4017807436341	92873IR
53	657414007	4017807434521	92873IR
53	657416007	4017807434552	92873IR
52	657493007	4017807436334	92873IR
52	657494007	4017807434415	92873IR
52	657496007	4017807434439	92873IR
578	659011801	4017807280081	
578	659011806	4017807508413	
578	659011832	4017807508406	
578	659011887	4017807280098	
602	659411806	4017807280050	
602	659412406	4017807280074	
316	670710507	4017807503470	92975RD
316	670710532	4017807503456	92975RD
317	670810607	4017807503531	92975RD
317	670810632	4017807503524	92975RD
338	671210131	4017807489835	
338	671210132	4017807489842	
339	671290131	4017807489859	92960RD
339	671290132	4017807489866	92960RD
74	671310105	4017807445329	
74	671310131	4017807451832	
74	671310142	4017807445312	
308	671610307	4017807391237	
308	671610331	4017807391244	
311	672110505	4017807503982	
311	672110542	4017807503951	
309	672310207	4017807503371	92966RD
309	672310231	4017807503333	92966RD
309	672310232	4017807503357	92966RD
313	672610332	4017807441208	
331	672810202	4017807503166	
331	672819202	4017807503173	
78	672910106	4017807299274	
312	673210306	4017807388411	
312	673210331	4017807388428	
312	673210332	4017807441192	
355	673311306	4017807358407	92912IR
302	673810206	4017807433333	
302	673810232	4017807433364	
303	673810306	4017807505689	
303	673810332	4017807505702	
302	673890206	4017807433371	
302	673890232	4017807433388	
306	673916007	4017807452594	
306	673916031	4017807452235	
306	673916032	4017807441437	
306	673918007	4017807452617	
306	673918031	4017807452259	
306	673918032	4017807441468	
337	674011207	4017807363708	
335	674011232	4017807556315	



Seite Page	Artikel-Nr. Product No.	EAN-Nummer EAN-Number	Ersatzteile Spare parts
336	674013007	4017807363630	
334	674013032	4017807556322	
337	674014507	4017807363654	
335	674014532	4017807556339	
337	674016207	4017807363692	
335	674016232	4017807556346	
336	674093007	4017807363623	
334	674093032	4017807556353	
336	674094507	4017807363647	
334	674094532	4017807556360	
336	674096207	4017807363685	
334	674096232	4017807556377	
324	674410307	4017807455854	
324	674410331	4017807477108	
324	674410342	4017807455847	
359	674510107	4017807381566	6587IR
320	674610507	4017807385786	
320	674610707	4017807450224	
92	675510507	4017807455779	
92	675510532	4017807455762	
363	675610106	4017807363302	92870RD 6289IR-2 6787IR 92863-241
323	676210307	4017807371918	
323	676210342	4017807425703	
323	676210407	4017807425734	
323	676210442	4017807425758	
322	676240306	4017807524871	
322	676240331	4017807524901	
322	676240406	4017807524925	
322	676240431	4017807524949	
328	676611031	4017807398533	92868RD
328	676615031	4017807398519	92868RD
328	676617531	4017807398526	92868RD
367	677718000	4017807337686	92804 6289IR-2
362	678513001	4017807431070	6289IR-2
360	678710006	4017807337730	6289IR-2 6787IR 92864
360	678711206	4017807337716	
360	678713006	4017807337723	6787IR 6289IR-2
361	679110032	4017807471069	6289IR-2
361	679112132	4017807471021	
361	679114232	4017807471045	6289IR-2
365	679210106	4017807440348	6289IR-2
354	679511532	4017807450767	
605	6801011-01	4017807259056	
605	6801011-06	4017807147575	9580
605	6801011-07	4017807147582	9580
605	6801011-32	4017807507690	
601	680213500	4017807508475	92930-35 92974IR

Seite Page	Artikel-Nr. Product No.	EAN-Nummer EAN-Number	Ersatzteile Spare parts
601	680214800	4017807508482	92930-48 92974IR
603	680310106	4017807508437	
603	680310132	4017807508444	
603	680319106	4017807508451	
603	680319132	4017807508468	
598	680710106	4017807507843	
598	680710131	4017807507867	
598	680710132	4017807507881	
574	680810306	4017807508505	
574	680810332	4017807508512	
574	680819306	4017807508529	
574	680819332	4017807508536	
576	682410506	4017807280845	
600	686014000	4017807507744	E6260-00
600	686014001	4017807507720	E6260-00
577	686412406	4017807507805	
577	686512406	4017807507829	
599	689214032	4017807507768	
599	689314032	4017807507782	
122	693900417	4017807409451	S693915-11 S693920-02 S693925-01 S693930-01 96939-15
122	693900517	4017807399547	S693920-11 S693925-02 S693930-02 S693935-01 S693940-01
536	700131	4017807470161	
536	700132	4017807470178	
536	700187	4017807470246	
536	700231	4017807470277	
536	700232	4017807470307	
536	700287	4017807470253	
536	701031	4017807470321	
536	701032	4017807470338	
536	701087	4017807470345	
536	701131	4017807474824	
536	701132	4017807474831	
536	701187	4017807474848	
543	701231	4017807470352	
543	701232	4017807470369	
543	701287	4017807470376	
539	702031	4017807470383	
539	702032	4017807470390	
539	702087	4017807470406	
539	702131	4017807470475	
539	702132	4017807470482	
539	702187	4017807470499	
539	702231	4017807470505	
539	702231A	4017807474855	
539	702232	4017807470543	
539	702232A	4017807474862	

Seite Page	Artikel-Nr. Product No.	EAN-Nummer EAN-Number	Ersatzteile Spare parts
539	702287	4017807470550	
539	702287A	4017807474879	
541	702331	4017807470567	
541	702331A	4017807482171	
541	702331B	4017807518900	
541	702332	4017807470574	
541	702332A	4017807482188	
541	702332B	4017807518924	
541	702387	4017807470581	
541	702387A	4017807482195	
541	702387B	4017807518948	
541	702431	4017807470598	
541	702432	4017807470604	
541	702487	4017807470611	
542	702531	4017807470628	
542	702532	4017807470635	
542	702587	4017807470642	
542	703031	4017807471397	
542	703032	4017807471403	
542	703087	4017807471410	
542	703131	4017807471427	
542	703132	4017807471434	
542	703187	4017807471441	
542	703231	4017807471458	
542	703232	4017807471465	
542	703287	4017807471472	
543	703331	4017807471489	
543	703332	4017807471502	
543	703387	4017807471519	
543	703431	4017807474886	
543	703531	4017807474893	
543	703532	4017807474909	
543	703587	4017807474916	
543	703952	4017807471533	
547	73043107	4017807505955	
547	73043131	4017807505931	
547	73043132	4017807505948	
552	73120102	4017807471557	
546	73240107	4017807471564	
546	73240108	4017807542684	
546	73240131	4017807471571	
546	73240132	4017807471588	
552	73330101	4017807471595	
552	73330111	4017807471618	92989-11
548	73430132	4017807506037	
548	73520101	4017807471656	
553	73820180	4017807505856	
552	76390201	4017807472110	
552	76390211	4017807472127	
553	76820280	4017807505832	
550	76921031	4017807505962	
550	76921032	4017807505979	
550	76921087	4017807505986	
550	76921531	4017807505993	
550	76921532	4017807506006	

Seite Page	Artikel-Nr. Product No.	EAN-Nummer EAN-Number	Ersatzteile Spare parts
550	76921587	4017807506013	
550	77020131	4017807472028	
550	77020132	4017807472035	
550	77020187	4017807472042	
548	78010107	4017807471946	
548	78010131	4017807471922	
548	78010132	4017807471939	
544	78030131	4017807505900	
544	78030132	4017807505917	
544	78030187	4017807505924	
544	78070107	4017807472073	
544	78070131	4017807472080	
544	78070132	4017807472103	
544	78150107	4017807505894	
544	78150131	4017807505870	
544	78150132	4017807505887	
548	78170107	4017807471663	
546	78240107	4017807471694	
546	78240108	4017807542660	
546	78240131	4017807471700	
546	78240132	4017807471724	
552	78330101	4017807471977	
552	78330111	4017807471991	
552	78330179	4017807472295	
548	78430132	4017807506020	
525	800300132	4017807351392	
525	800300232	4017807351415	
525	800300432	4017807351644	
508	800700107	4017807469103	
508	800700131	4017807469127	
508	800700132	4017807469141	
508	800700207	4017807469165	
508	800700231	4017807469202	
508	800700232	4017807469226	
508	800700307	4017807469264	
508	800700331	4017807469288	
508	800700332	4017807469301	
508	800700407	4017807469325	
508	800700431	4017807469349	
508	800700432	4017807469363	
260	801900167	4017807502558	
260	801900267	4017807502565	
260	801900367	4017807502589	
512	802400101	4017807227543	
514	802400104	4017807490534	
514	802400107	4017807231335	
512	802400124	4017807408621	
512	802400132	4017807408614	
510	802400180	4017807523898	
512	802400201	4017807227550	
514	802400204	4017807490558	
514	802400207	4017807231359	
512	802400224	4017807408645	
512	802400232	4017807408638	
510	802400280	4017807523911	



Seite Page	Artikel-Nr. Product No.	EAN-Nummer EAN-Number	Ersatzteile Spare parts
512	802400301	4017807227567	
514	802400304	4017807490572	
514	802400307	4017807231373	
512	802400324	4017807408669	
512	802400332	4017807408652	
510	802400380	4017807523935	
513	802430401	4017807227574	
515	802430404	4017807490596	
515	802430407	4017807231397	
513	802430424	4017807408683	
513	802430432	4017807408676	
510	802430480	4017807523959	
524	802500178	4017807299519	
524	802500278	4017807299526	
524	802500378	4017807299540	
522	803000107	4017807348262	
522	803000207	4017807348279	
523	803000307	4017807348286	
523	803090307	4017807348323	
256	803400167	4017807430196	
256	803400267	4017807430202	
256	803400367	4017807430219	
506	803500131	4017807408201	S8035-02
506	803500132	4017807408225	S8035-02
506	803500231	4017807408232	S8035-02
506	803500232	4017807408249	S8035-02
506	803500331	4017807408256	S8035-02
506	803500332	4017807408263	S8035-02
506	803590431	4017807408294	S8035-02
506	803590432	4017807408300	S8035-02
274	804300332	4017807467666	
274	804300432	4017807467680	
274	804370132	4017807467604	
274	804370232	4017807467642	
268	805300188	4017807445183	
268	805300288	4017807445190	
268	805300388	4017807445206	
268	805300488	4017807445213	
114	811400132	4017807538335	
114	811400232	4017807538359	
114	811400432	4017807538397	
114	811430332	4017807538373	
526	811900131	4017807522815	
146	811900132	4017807522792	
526	811900231	4017807522860	
146	811900232	4017807522877	
526	811900331	4017807522921	
146	811900332	4017807522938	
516	812400107	4017807487947	
516	812400131	4017807487961	
516	812400132	4017807487954	
516	812400207	4017807487978	
516	812400231	4017807487992	
516	812400232	4017807487985	
516	812400307	4017807488005	

Seite Page	Artikel-Nr. Product No.	EAN-Nummer EAN-Number	Ersatzteile Spare parts
516	812400331	4017807488029	
516	812400332	4017807488012	
516	812400407	4017807488036	
516	812400431	4017807488067	
516	812400432	4017807488043	
528	813400127	4017807540789	
528	813400227	4017807540833	
528	813400427	4017807540857	
528	813430327	4017807540864	
503	821410305	4017807220902	92426 92426-35 959-745 92389-02
502	821410405	4017807220919	92426 92426-35 959-745 92389-03
502	821410605	4017807220933	92426 92426-35 959-745 92389-04
503	821430405	4017807220926	92426 92426-35 959-745
503	821470105	4017807220889	92426 92426-35 959-745 92389
502	821470205	4017807220896	92426 92426-35 92389-01
520	871010107	4017807281637	92734 92910
520	871010108	4017807281644	92734 92910
520	871010207	4017807281651	92734 92910
520	871010208	4017807281668	92734 92910
520	871010307	4017807281675	92734 92910
520	871010308	4017807281682	92734 92910
520	871010407	4017807281712	92734 92910
520	871010408	4017807281729	92734 92910
520	871010607	4017807281736	92734 92910
520	871010608	4017807281743	92734 92910
521	871090307	4017807281699	92734 92910
521	871090308	4017807281705	92734 92910

Seite Page	Artikel-Nr. Product No.	EAN-Nummer EAN-Number	Ersatzteile Spare parts
518	871510207	4017807284904	92739
518	871510407	4017807284966	92739
519	871510607	4017807284980	92739
518	871570107	4017807284898	92739
518	871590307	4017807284942	92739
504	873110307	4017807302615	
504	873110331	4017807302622	
505	873110407	4017807302639	
505	873110431	4017807302646	
505	873110607	4017807302653	
505	873110631	4017807302660	
504	873170107	4017807302578	
504	873170131	4017807302585	
504	873170207	4017807302592	
504	873170231	4017807302608	
594	880400106	4017807508031	
594	880400132	4017807508048	
594	880400406	4017807508383	
594	880400432	4017807508390	
594	880430306	4017807508369	
594	880430332	4017807508376	
413	891010107	4017807358049	92734
412	8911211-07	4017807118780	9568-07
413	891770107	4017807358162	92816
412	899670107	4017807358155	
271	92945	4017807478174	
611	901-479	4017807351446	
611	902-479	4017807351453	
611	903-479	4017807351460	
611	904-479	4017807351477	
614	929-220	4017807293319	
614	929-230	4017807355000	
614	929-2300	4017807394924	
615	955-50	4017807277074	
614	955-55	4017807277098	
615	956-30	4017807277050	
615	956-330	4017807509151	
615	956-355	4017807509144	
615	956-509	4017807508987	
615	956-55	4017807300369	
615	956-5736	4017807380057	
615	956-5936	4017807380071	
613	983-200	4017807508840	
613	983-279	4017807508857	
614	983-3200	4017807508901	
614	983-3279	4017807508932	
614	983-3400	4017807543155	
612	983-40	4017807240566	
613	983-400	4017807302097	
613	983-410	4017807394900	
612	983-43	4017807260540	
613	983-4470	4017807358940	
613	983-479	4017807530612	
613	983-4790	4017807509137	
612	983-509	4017807508963	

Seite Page	Artikel-Nr. Product No.	EAN-Nummer EAN-Number	Ersatzteile Spare parts
612	983-56	4017807394863	
612	983-60	4017807279214	
612	983-63	4017807279221	
612	983-66	4017807300345	
609	985-6810	4017807358759	
608	986-40	4017807268782	
608	986-43	4017807268799	
608	986-60	4017807280647	
608	986-63	4017807280654	
610	986-6790	4017807509120	
610	986-6810	4017807358766	
610	986-710	4017807433463	
609	987-2400	4017807303933	
609	987-2479	4017807509113	
608	987-260	4017807509090	
608	987-400	4017807287509	
609	987-410	4017807394917	
609	987-479	4017807509106	
608	987-60	4017807279252	
610	987-600	4017807288056	
609	987-6700	4017807387636	
610	987-679	4017807288049	
608	987-6810	4017807358735	
608	987-7009	4017807508949	
608	987-909	4017807508956	
608	988-10	4017807300338	
608	988-110	4017807394894	
609	988-600	4017807287516	
610	988-679	4017807287530	
608	988-700	4017807394887	
610	988-710	4017807433449	
613	989-200	4017807508864	
613	989-279	4017807508871	
613	989-3200	4017807508918	
613	989-3279	4017807508925	
613	989-3400	4017807543162	
612	989-40	4017807240597	
613	989-400	4017807287486	
612	989-43	4017807260557	
613	989-4470	4017807358926	
613	989-479	4017807287523	
613	989-4790	4017807509083	
612	989-509	4017807508970	
612	989-56	4017807394870	
612	989-60	4017807279238	
612	989-63	4017807279245	
612	989-66	4017807300352	
613	990-200	4017807508895	
613	990-279	4017807508888	
612	990-40	4017807240610	
613	990-400	4017807287493	
613	990-4470	4017807358933	
613	990-4790	4017807509076	



# KONTAKTE

Contact · Contact · Contact · Contactar · Contatto · Contact · Yhteydenotto · Kontakt

## TRIO Leuchten GmbH

Gut Nierhof 17  
D-59757 Arnsberg

T +49 (0) 2931 9666-0  
F +49 (0) 2931 9666-57

info@trio-leuchten.de  
www.trio-leuchten.de

## BADEN WÜRTTEMBERG, RHEINLAND-PFALZ UND SAARLAND

### Antonio De Simone

T +49 (0) 151 5855222  
antonio.desimone@trio-leuchten.de

## BAYERN, HESSEN

### Martin Kluge

T +49 (0) 171 7300330  
martin.kluge@trio-leuchten.de

## BERLIN, BRANDENBURG, MECKLENBURG-VORPOMMERN, SACHSEN, SACHSEN ANHALT, THÜRINGEN

### Jörg Bumke

T +49 (0) 160 7406860  
joerg.bumke@trio-leuchten.de

## BREMEN, HAMBURG, NIEDERSACHSEN, SCHLESWIG-HOLSTEIN

### Jens Gebers

T +49 (0) 170 1615227  
jens.gebers@trio-leuchten.de

## NORDRHEIN-WESTFALEN

### Christian Teller

T +49 (0) 171 4521820  
christian.teller@trio-leuchten.de

## ÖSTERREICH

### Wolfgang Melich

T +43 (0) 6605161228  
wolfgang.melich@trio-leuchten.de

## SCHWEIZ

### TRIO Leuchten

T +49 (0) 2931 9666-0  
info@trio-leuchten.de

## TRIO International GmbH

Gut Nierhof 17  
D-59757 Arnsberg

T +49 (0) 2931 9666-587  
F +49 (0) 2931 9666-56

info@trio-lighting.com  
www.trio-lighting.com

## FRANCE

### Stéphane Papierny

Directeur Commercial France  
info.france@trio-lighting.com

### Sullivan Nicolas

info.france@trio-lighting.com  
*Agent exclusif pour les départements  
01, 03, 07, 21, 26, 38, 39, 42,  
43, 48, 63, 69, 71, 73 et 74*

### Vincent Zaepffel

info.france@trio-lighting.com  
*Commercial pour les départements  
02, 08, 10, 25, 51, 52, 54, 55, 57, 59, 62,  
67, 68, 70, 80, 88 et 90*

### Christophe Meulien

info.france@trio-lighting.com  
*Agent exclusif pour les départements  
04, 05, 06, 11, 13, 30, 34, 66, 83 et 84*

### Jean Barel

info.france@trio-lighting.com  
*Agent exclusif pour les départements  
09, 12, 15, 16, 19, 23, 24, 31, 32, 33, 40,  
46, 47, 64, 65, 81, 82 et 87*

### Michel Salamand

info.france@trio-lighting.com  
*Agent exclusif pour les départements  
14, 17, 22, 29, 35, 36, 37, 41, 44, 49, 50,  
53, 56, 61, 72, 79, 85 et 86*

### Stéphane Riebel

info.france@trio-lighting.com  
*Agent exclusif pour les départements  
18, 45, 58, 75 Sud, 77, 78, 89, 91 et 94*

## Elsa Seron

info.france@trio-lighting.com  
*Agent exclusif pour les départements  
27, 28 et 76*

## Jean Philippe Bailly

info.france@trio-lighting.com  
*Agent exclusif pour les départements  
60, 75 Nord, 92, 93 et 95*

## DANMARK

### Jan Rantzau-Bartens

info.denmark@trio-lighting.com

## SUOMI

### TRIO Lighting Scandinavia Oy

Malmin raitti, rappu 17 B  
00700 Helsinki  
T +358 (0) 10 23 13 390  
F +358 (0) 10 23 13 399  
info.scandinavia@trio-lighting.com

Our Scandinavian organisation represents TRIO  
also in Sweden, Norway, Estonia, Latvia  
and Lithuania

## ITALIA

### TRIO Lighting Italia s.r.l

Via Dosso Fauti, 3  
22066 Mariano Comense (CO)  
T +39 (0) 317 477 55  
F +39 (0) 313 551 560  
info.italia@trio-lighting.com

## ESPAÑA

### TRIO Lighting Ibèrica SL

C/ Can Lietget n°9 nave 9  
Pol. Ind. Can Roqueta  
08206 Sabadell  
T +34 (0) 9 35 45 86 30  
F +34 (0) 9 33 96 45 48  
info.iberica@trio-lighting.com

## GREAT BRITAIN

### TRIO Lighting UK Ltd.

Unit 5, Hemmells Park Hemmells, Laindon  
Essex  
SS1s 6GF  
T +44 (0) 12 68 88 95 95  
F +44 (0) 12 68 88 95 96  
sales@trio-lightinguk.com

## NEDERLAND

### Karl Stok / Bas Martin

info.nederland@trio-lighting.com

## BELGIUM/BELGIQUE

### Yves van den Berghe

info.belgium@trio-lighting.com

## ROMANIA

### Gina Ionita

info.romania@trio-lighting.com

 @trioleuchten

 /trioleuchten

 @trio.lighting





# SAVE THE DATE



**LICHTWOCHE**  
SAUERLAND

05. – 10.03.2023

lichtforumnrw

TRIO behält sich das Recht vor, zu jeder Zeit, notwendige Änderungen oder Aktualisierungen der in diesem Katalog enthaltenen Produkte vorzunehmen. · TRIO reserves the right to carry out any time, necessary changes or updates of the products in this catalogue. · TRIO se réserve le droit d'apporter à tout moment les modifications ou actualisations nécessaires aux produits dans ce catalogue. · TRIO behoudt zich het recht voor op ieder moment noodzakelijke wijzigingen of updates aan de producten in deze catalogus door te voeren. · TRIO se reserva , en todo momento, el derecho a realizar las modificaciones o actualizaciones que considere necesarias para cualquier producto de este catálogo. · TRIO si riserva il diritto di apportare, in qualunque momento, tutte le modifiche necessarie ai prodotti di questo catalogo. · TRIO-ul își rezervă dreptul de a face oricând orice modificări sau actualizări necesare pentru produsele din acest catalog. · TRIO pidättää oikeuden tehdä muutoksia tai päivittää tuotteita tässä luettelossa. · TRIO zastrzega sobie prawo do wprowadzania w dowolnym czasie zmian lub aktualizacji produktów zawartych w katalogu.



**TRIO Leuchten GmbH**

Gut Nierhof 17  
D-59757 Arnsberg

T +49 (0) 2931 9666-0  
F +49 (0) 2931 9666-28

info@trio-leuchten.de  
www.trio-leuchten.de

**TRIO International GmbH**

Gut Nierhof 17  
D-59757 Arnsberg

T +49 (0) 2931 9666-587  
F +49 (0) 2931 9666-56

info@trio-lighting.com  
www.trio-lighting.com

 @trioleuchten

 /trioleuchten

 @trio.lighting

LIGHTING FOR YOU