

**(DE) ACHTUNG!**

Vor Beginn der Montagearbeiten lesen Sie bitte aufmerksam die Sicherheitshinweise!

**(EN) WARNING!**

Before assembling, please read carefully the safety instructions!

**(NL) LET OP!**

Lees de veiligheidsinstructies zorgvuldig door voordat u met de montage begint!

**(FR) ATTENTION!**

Avant le début des travaux de montage, prière de lire attentivement les consignes de sécurité

**(IT) ATTENZIONE!**

Prima di installare leggere attentamente l'avviso di sicurezza!

**(ES) ATENCIÓN!**

Antes de comenzar con los trabajos de montaje leer detenidamente los avisos de seguridad!

**(PL) UWAGA!**

Przed przystąpieniem do prac montażowych uważnie należy przeczytać wskazówki bezpieczeństwa!

**(FI) HUOMIO!**

Ennen asennustöiden aloittamista pyydämme Teitä lukemaan turvaohjeet huolellisesti!

**(CZ) POZOR!**

Než začnete provádět montážní práce, přečtěte si důkladně bezpečnostní pokyny!

**(RU) ВНИМАНИЕ!**

До начала монтажных работ внимательно прочтите эти указания по технике безопасности!

**(GR) ΠΡΟΣΟΧΗ!**

Πριν την διεξαγωγή της συναρμολόγησης διαβάστε προσεκτικά τις υποδείξεις ασφαλείας!

**(RO) ATENȚIUNE!**

A se citi cu atenție indicațiile privind siguranța, înainte de începerea montării!

**(BG) ВНИМАНИЕ!**

Преди Да Започнете работите по монтажа прочетете ВНИМАТЕЛНО упрТВаниеТо За безопасност!

**(TR) DİKKAT!**

Montaja başlamadan önce güvenlik talimatnamesini titizlikle okuyunuz!

**(HU) FLGYELEM!**

A szerelési munkák megkezdése előtt figyelmesen olvassa el a biztonsági útmutatásokat!

**(SV) OBS!**

Läs säkerhetsanvisningarna noga innan du börjar med monteringsarbetena!

**(HR) POZOR!**

Prije početka montaže molimo pozorno pročitajte sigurnosne naputke!

**(SL) POZOR!**

Prosim, da pred zacetkom montaze, zaradi varnosti preberete vas navodila, ki so prilozena!

**(SK) POZOR!**

Pred tým ako začnete robit' montážne práce, prečítajte si dôkladne bezpečnostné pokyny!

**(PT) CUIDADO!**

Antes de iniciar os trabalhos de montagem por favor leia atentamente os avisos de segurança!

**(BA) POZOR!**

Prije početka montaže molimo pažljivo pročitajte sigurnosne upute!

**(LT) DĖMESIO!**

Norėdami saugiai ir teisingai sumontuoti šviestuv vadovaukitės šia instrukcija!

**(ET) HOIATUS!**

Enne monteerimist lugege ohutusjuhised tähelepanelikult läbi!

**(DA) OBS!**

Læs sikkerhedsinformationen nøje, før du monterer produktet!

**(NO) ADVARSEL!**







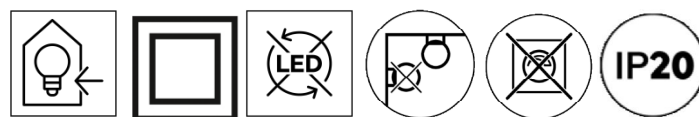
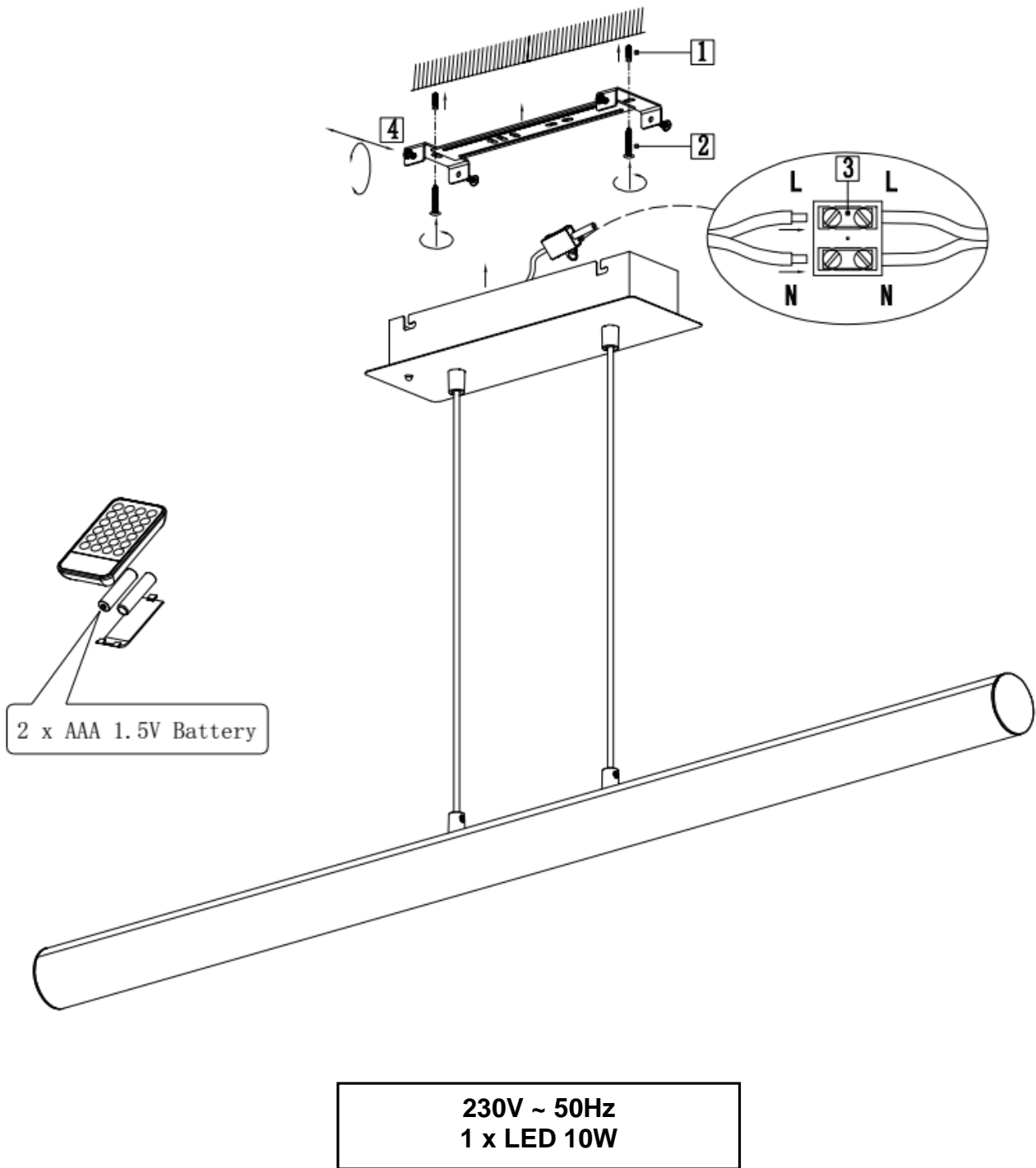

Les sikkerhetsinformasjonen nøye før du monterer produktet!

**(LV) UZMANĪBU!**

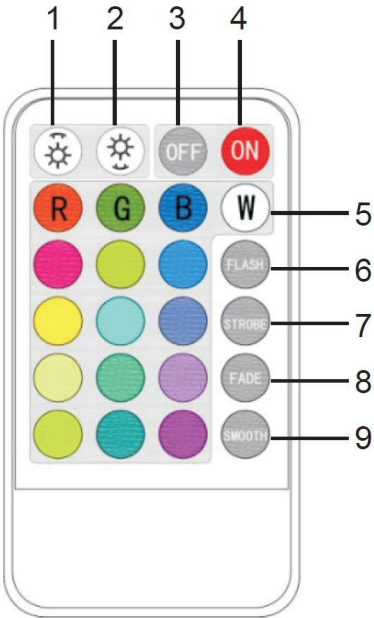

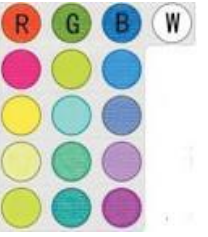





Pirms montāžas uzmanīgi izlasiet drošības norādījumus!

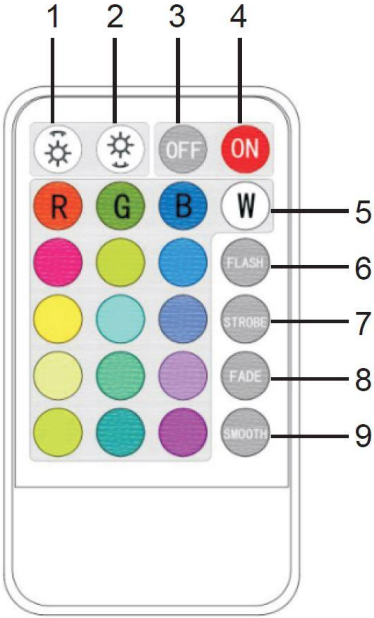







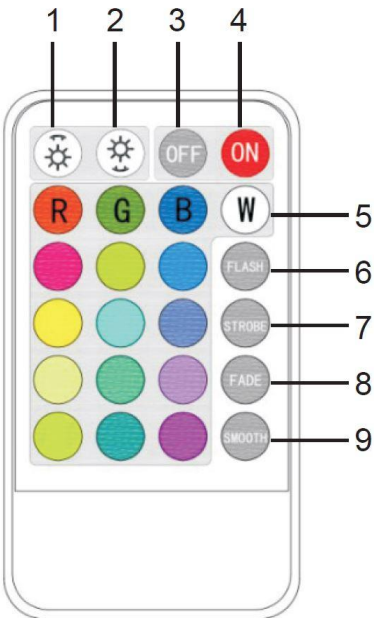

## Funktionsweise der Fernbedienung

1	 	Helligkeit erhöhen	
2		Helligkeit reduzieren	
3	 	Gerät ausschalten	
4		Gerät einschalten	
5		Direktauswahl von 16 Farben beim Drücken der jeweiligen Tasten.	
6		Farbmodus «FLASH»	
7		Farbmodus «STROBE»	
8		Farbmodus «FADE»	
9		Farbmodus «SMOOTH»	



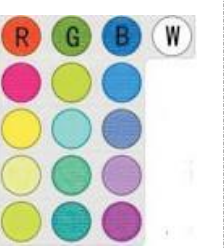



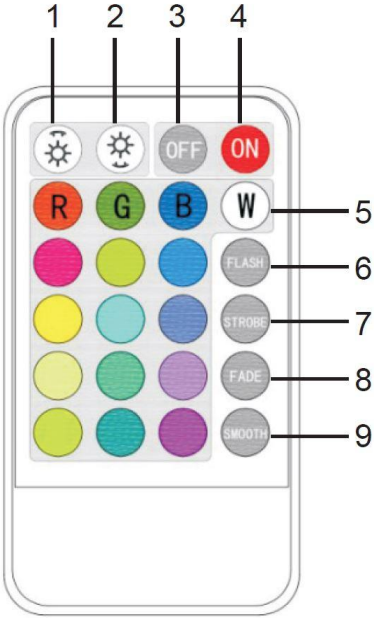

## Operation with the remote control

1		Increase brightness	
2		Reduce brightness	
3		Switch the lamp off	
4		Switch the lamp on	
5		16 colors can be selected directly by pressing a button	
6		Color mode «FLASH»	
7		Color mode «STROBE»	
8		Color mode «FADE»	
9		Color mode «SMOOTH»	







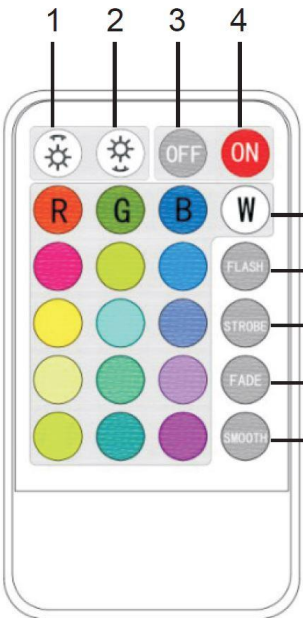

## Operación con el control remote

1		Aumenta el brillo	
2		Reduce el brillo	
3		Apaga la lámpara	
4		Enciende la lámpara	
5		Selección inmediata de 16 colores al pulsar el botón correspondiente	
6		Modo de color «FLASH»	
7		Modo de color «STROBE»	
8		Modo de color «FADE»	
9		Modo de color «SMOOTH»	



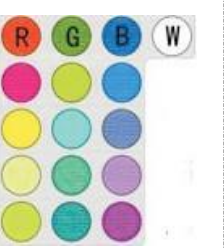



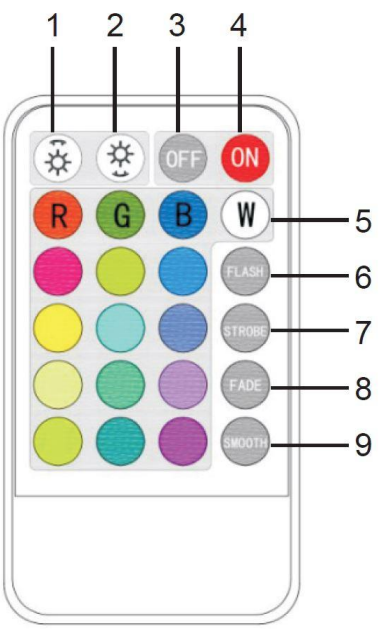

## Funzionamento con il telecomando

1		Aumenta la luminosità	
2		Riduci la luminosità	
3		Spegni la lampada	
4		Accendi la lampada	
5		Selezione diretta di 16 colori premendo il relativo pulsante	
6		Modalità colore «FLASH»	
7		Modalità colore «STROBE»	
8		Modalità colore «FADE»	
9		Modalità colore «SMOOTH»	

## Fonctionnement avec la télécommande







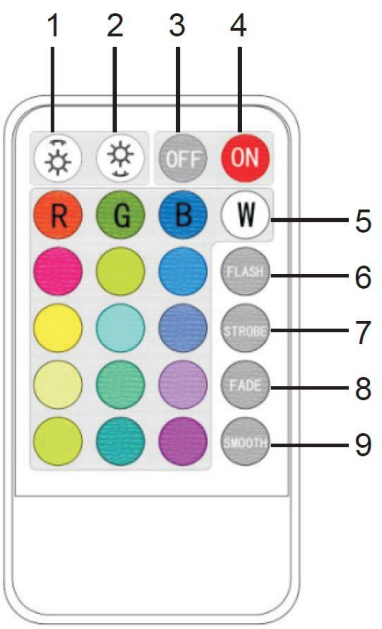

1		Augmentez la luminosité	
2		Réduisez la luminosité	
3		Éteignez la lampe	
4		Allumez la lampe	
5		Sélectionnez directement 16 couleurs en appuyant sur le bouton correspondant	
6		Mode couleur «FLASH»	
7		Mode couleur «STROBE»	
8		Mode couleur «FADE»	
9		Mode couleur «SMOOTH»	

## Работа с дистанционното управление









1		Увеличаване на яркостта	
2		Намаляване на яркостта	
3		Изключване на лампата	
4		Включване на лампата	
5		Директен избор на 16 цвята чрез натискане на съответния бутон	
6		Цветови режим «FLASH»	
7		Цветови режим «STROBE»	
8		Цветови режим «FADE»	
9		Цветови режим «SMOOTH»	

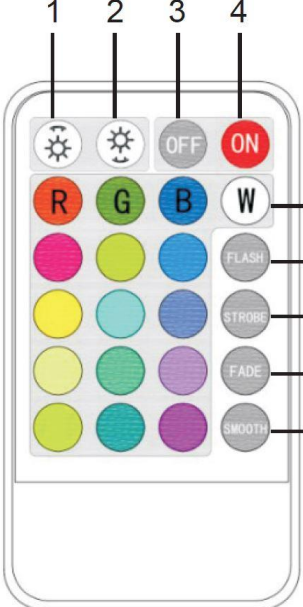







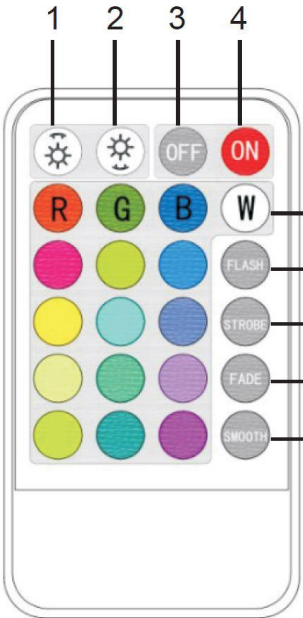

## Rukovanje daljinskim upravljačem

1		Povećajte osvijetljenost	
2		Smanjite osvijetljenost	
3		Isključite lampu	
4		Uključite lampu	
5		Direktan izbor 16 boja pritiskom na odgovarajuće dugme	
6		Režim boje «FLASH»	
7		Režim boje «STROBE»	
8		Režim boje «FADE»	
9		Režim boje «SMOOTH»	







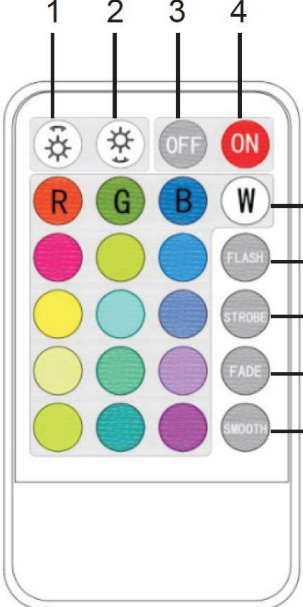

## Operace s dálkovým ovládáním

1		Zvýšit jas	
2		Snížit jas	
3		Vypnout svítidlo	
4		Zapnout svítidlo	
5		Vyberte si z 16 barev stisknutím příslušného tlačítka	
6		Barevný režim «FLASH»	
7		Barevný režim «STROBE»	
8		Barevný režim «FADE»	
9		Barevný režim «SMOOTH»	







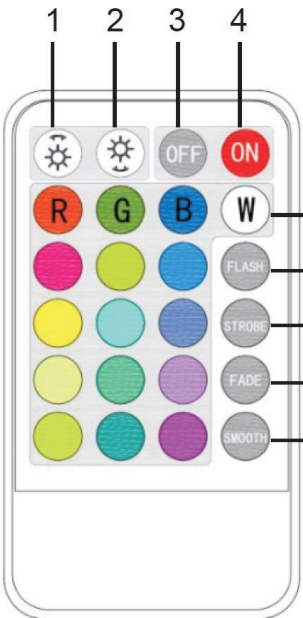

## Betjening med fjernbetjeningen

1		Skru op for lysstyrke	
2		Skru ned for lysstyrke	
3		Sluk for lampen	
4		Tænd for lampen	
5		Direkte valg af 16 farver ved at trykke på den tilhørende knap	
6		Farvetilstand «FLASH»	
7		Farvetilstand «STROBE»	
8		Farvetilstand «FADE»	
9		Farvetilstand «SMOOTH»	







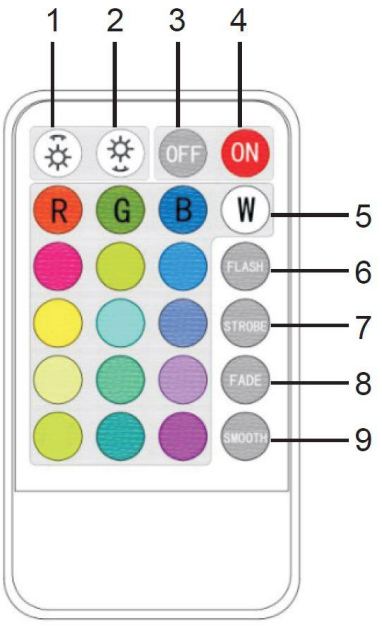

## Λειτουργία με το τηλεχειριστήριο

1		Αύξηση φωτεινότητας	
2		Μείωση φωτεινότητας	
3		Απενεργοποίηση λάμπας	
4		Ενεργοποίηση λάμπας	
5		Άμεση επιλογή 16 χρωμάτων με το πάτημα του σχετικού κουμπιού	
6		Λειτουργία χρώματος «FLASH»	
7		Λειτουργία χρώματος «STROBE»	
8		Λειτουργία χρώματος «FADE»	
9		Λειτουργία χρώματος «SMOOTH»	



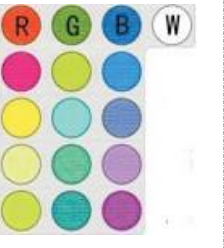



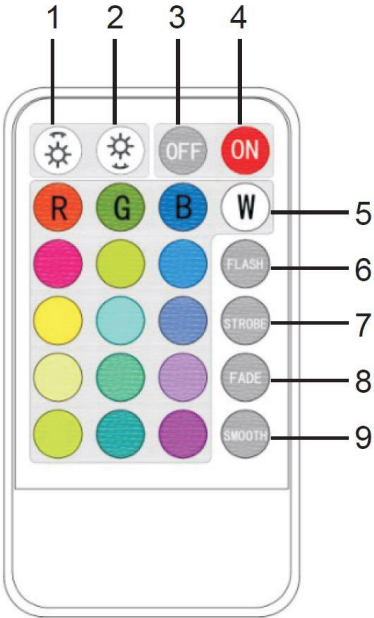

## Kaugjuhtimisseadme käsitsemine

1		Suurendage heledust	
2		Vähendage heledust	
3		Lülitage lamp välja	
4		Lülitage lamp sisse	
5		16 värvi otsene valik, vajutades sellega seotud nupule	
6		Värvirežiim «FLASH»	
7		Värvirežiim «STROBE»	
8		Värvirežiim «FADE»	
9		Värvirežiim «SMOOTH»	







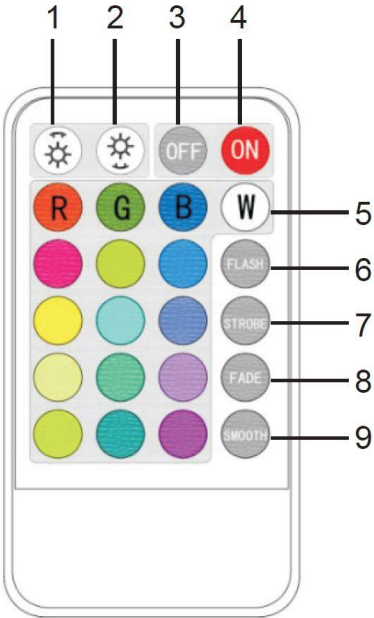

## Käyttö kaukosäätimellä

1		Lisää kirkkautta	
2		Vähennä kirkkautta	
3		Kytke valaisin pois päältä	
4		Kytke valaisin päälle	
5		Suora 16 värin valinta painikkeilla	
6		Väritila «FLASH»	
7		Väritila «STROBE»	
8		Väritila «FADE»	
9		Väritila «SMOOTH»	

## Upravljanje daljinskim upravljačem







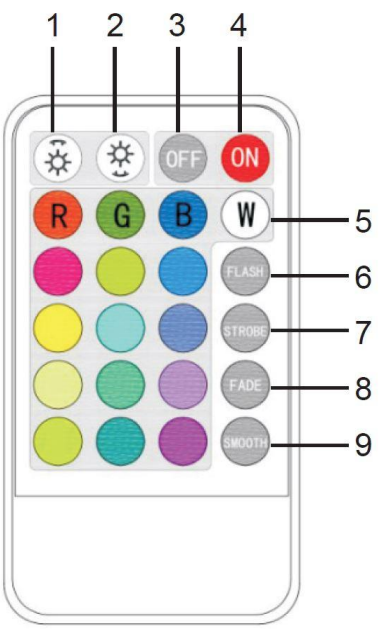

1		Povećaj svjetlinu	
2		Smanji svjetlinu	
3		Ugasi lampu	
4		Upali lampu	
5		Izravan odabir 16 boja pritiskom na odgovarajući gumb	
6		Način rada u boji «FLASH»	
7		Način rada u boji «STROBE»	
8		Način rada u boji «FADE»	
9		Način rada u boji «SMOOTH»	

## Kezelés a távvezérlővel









1		Fényerő növelése	
2		Fényerő csökkentése	
3		Lámpa lekapcsolása	
4		Lámpa felkapcsolása	
5		Közvetlen választás a 16 szín közül a megfelelő gomb megnyomásával	
6		«FLASH» színmód	
7		«STROBE» színmód	
8		«FADE» színmód	
9		«SMOOTH» színmód	

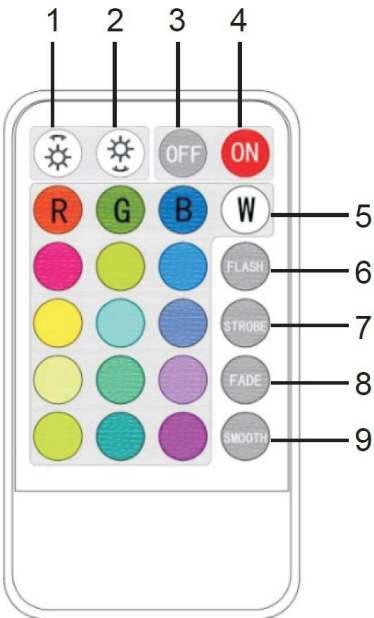







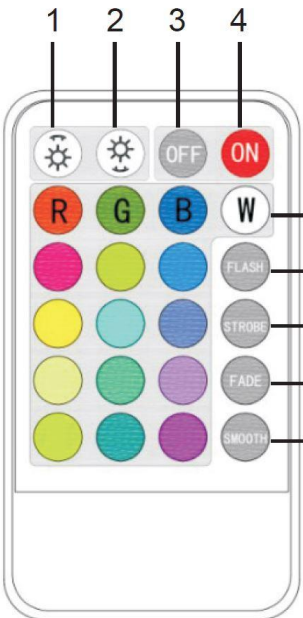

## Oreguliacija nuotolinio valdymo pulteliu

1		Ryšumo padidinimas	
2		Ryšumo sumažinimas	
3		Lempos išjungimas	
4		Lempos įjungimas	
5		Pasirinkimas tiesiogiai iš 16 spalvų, paspaudus atitinkamą mygtuką	
6		Spalvos režimas «FLASH» (žybsėjimas)	
7		Spalvos režimas «STROBE» (blyksėjimas)	
8		Spalvos režimas «FADE» (laipsniškas ryškumo mažėjimas)	
9		Spalvos režimas «SMOOTH» (tolygumas)	







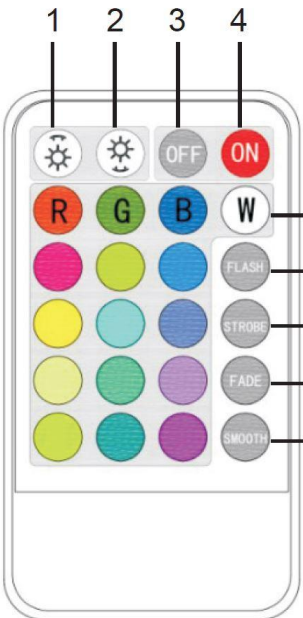

*Lietošana, izmantojot tālvadības pulti*

1		Palielināt spilgtumu	
2		Samazināt spilgtumu	
3		Izslēgt lampu	
4		Ieslēgt lampu	
5		Tieša 16 krāsu izvēle, nospiežot attiecīgo pogu	
6		Krāsu režīms «FLASH»	
7		Krāsu režīms «STROBE»	
8		Krāsu režīms «FADE»	
9		Krāsu režīms «SMOOTH»	







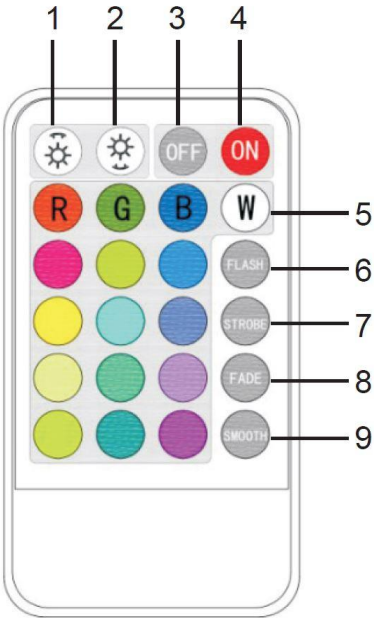

## Bediening met de afstandsbediening

1		Helderheid verhogen	
2		Helderheid verlagen	
3		De lamp uitzetten	
4		De lamp aanzetten	
5		Directe selectie van 16 kleuren door op de overeenkomstige toets te drukken	
6		Kleurmodus «FLASH»	
7		Kleurmodus «STROBE»	
8		Kleurmodus «FADE»	
9		Kleurmodus «SMOOTH»	







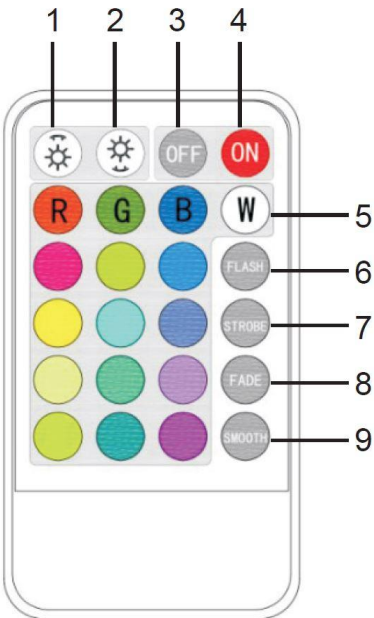

## Drift med fjernkontrollen

1		Øk lysstyrke	
2		Reduser lysstyrke	
3		Slå av lampen	
4		Slå på lampen	
5		Direkte valg av 16 farger ved å trykke på relatert knapp	
6		Fargemodus «FLASH»	
7		Fargemodus «STROBE»	
8		Fargemodus «FADE»	
9		Fargemodus «SMOOTH»	



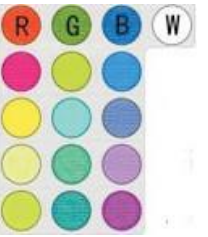



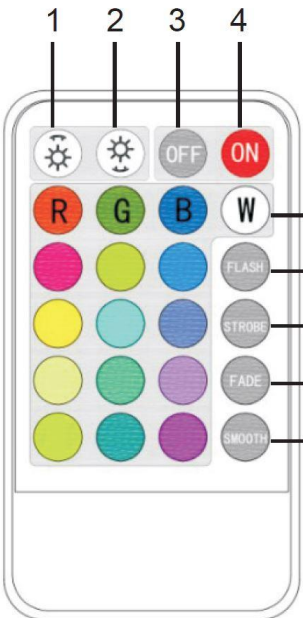

## Obsługa pilotem zdalnego sterowania

1		Zwiększanie jasności	
2		Zmniejszanie jasności	
3		Wyłączanie lampy	
4		Włączanie lampy	
5		Bezpośredni wybór 16 kolorów poprzez naciśnięcie odpowiedniego przycisku	
6		Tryb koloru «FLASH»	
7		Tryb koloru «STROBE»	
8		Tryb koloru «FADE»	
9		Tryb koloru «SMOOTH»	







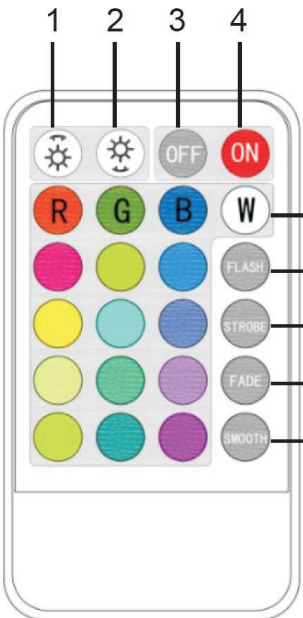

### Utilização com o controlo remote

1		Aumentar a luminosidade	
2		Diminuir a luminosidade	
3		Desligar a lâmpada	
4		Ligar a lâmpada	
5		É possível seleccionar directamente 16 cores premindo o botão correspondente	
6		Modo de cor «FLASH»	
7		Modo de cor «STROBE»	
8		Modo de cor «FADE»	
9		Modo de cor «SMOOTH»	

### Utilizarea telecomenzii







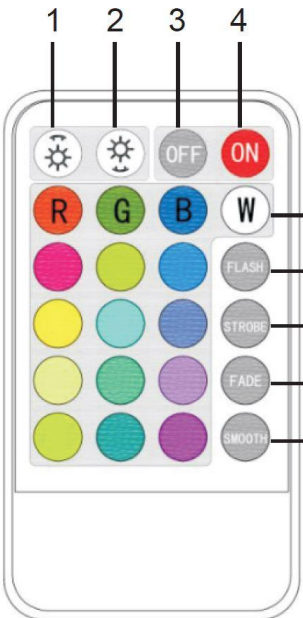

1		Creștere luminozitatea	
2		Micșorare luminozitatea	
3		Pornire lumină	
4		Oprire lumină	
5		Selectare directă a 16 culori prin apăsarea butonului corespunzător	
6		Mod culoare «FLASH»	
7		Mod culoare «STROBE»	
8		Mod culoare «FADE»	
9		Mod culoare «SMOOTH»	

### Работа под дистанционным управлением









1		Увеличить яркость	
2		Уменьшить яркость	
3		Выключить лампу	
4		Включить лампу	
5		Непосредственный выбор 16 цветов нажатием соответствующей кнопки	
6		Цветовой режим «FLASH»	
7		Цветовой режим «STROBE»	
8		Цветовой режим «FADE»	
9		Цветовой режим «SMOOTH»	

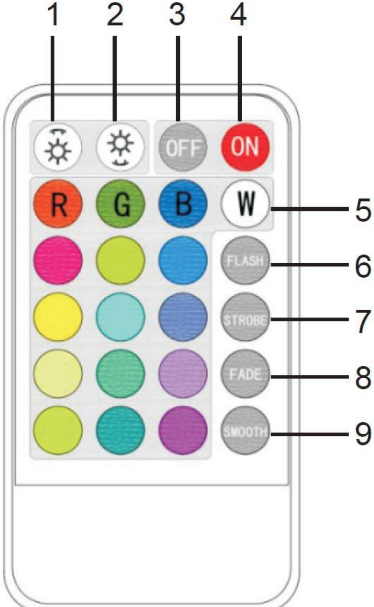



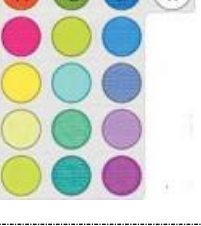



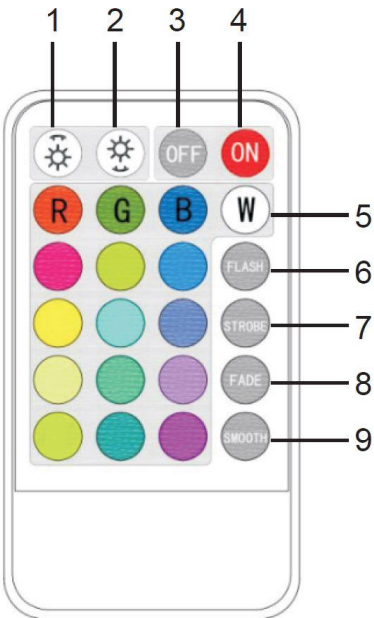

## Obsluha pomocou diaľkového ovládania

1		Zvýšenie jasú	
2		Zníženie jasú	
3		Vypnutie lampy	
4		Zapnutie lampy	
5		Priamy výber 16 farieb stlačením príslušného tlačidla	
6		Režim farby «FLASH»	
7		Režim farby «STROBE»	
8		Režim farby «FADE»	
9		Režim farby «SMOOTH»	









## Upravljanje z daljinskim upravljalnikom

1		Povečajte svetlost	
2		Zmanjšajte svetlost	
3		Izklopite žarnico	
4		Vklopite žarnico	
5		Neposredna izbira 16 barv s pritiskom ustreznega gumba	
6		Barvni način «FLASH»	
7		Barvni način «STROBE»	
8		Barvni način «FADE»	
9		Barvni način «SMOOTH»	

## Funktioner med fjärrkontrollen

1		Öka ljusstyrkan	
2		Minska ljusstyrkan	
3		Släcka lampan	
4		Tända lampan	
5		Direkt val av 16 färger genom att trycka på avsedd knapp	
6		Färgläge «FLASH»	
7		Färgläge «STROBE»	
8		Färgläge «FADE»	
9		Färgläge «SMOOTH»	

## Uzaktan kumanda ile alıřtırma

1		Parlaklıęı artır
2		Parlaklıęı azalt
3		Lambayı kapat
4		Lambayı a
5		İlgili dğmeye basılarak doęrudan 16 renk seimi
6		«FLASH» Renk modu
7		«STROBE» Renk modu
8		«FADE» Renk modu
9		«SMOOTH» Renk modu

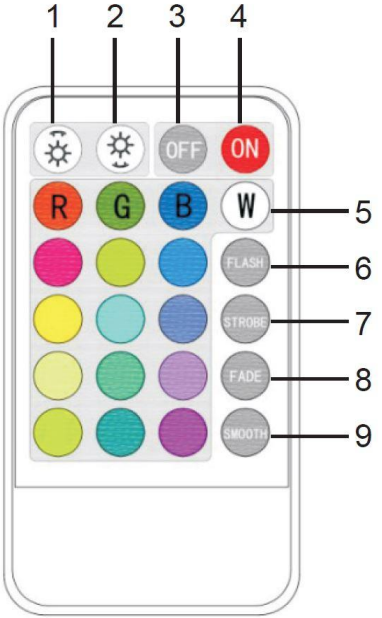

The remote control device is shown with buttons numbered 1 to 9. Buttons 1 and 2 are at the top left, 3 and 4 are at the top right. Buttons 5-9 are in a grid below. Buttons 5-9 are labeled R, G, B, W, FLASH, STROBE, FADE, and SMOOTH respectively.